

# Service Manual

## Air-to-Water Heatpump

**Indoor Unit**  
**WH-SXC09H3E5**  
**WH-SXC12H6E5**

**Outdoor Unit**  
**WH-UX09HE5**  
**WH-UX12HE5**

**Destination**  
**Europe**

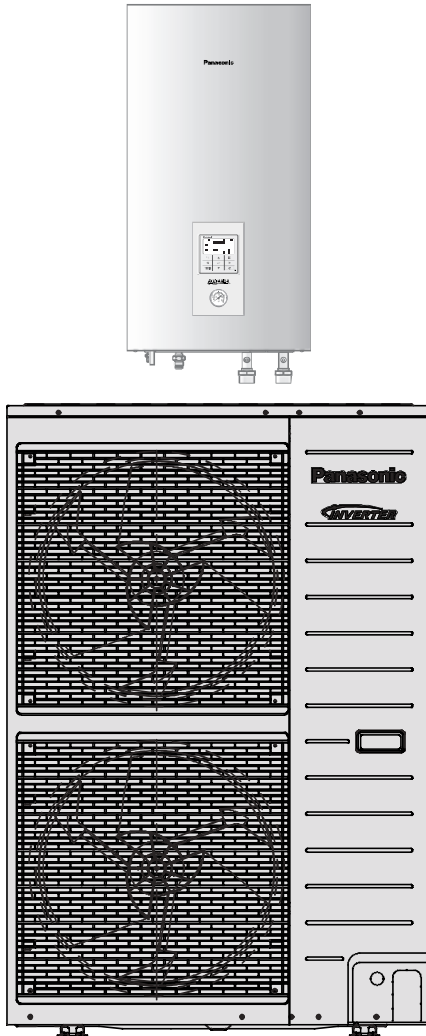

### **WARNING**

This service information is designed for experienced repair technicians only and is not designed for use by the general public. It does not contain warnings or cautions to advise non-technical individuals of potential dangers in attempting to service a product. Products powered by electricity should be serviced or repaired only by experienced professional technicians. Any attempt to service or repair the products dealt with in this service information by anyone else could result in serious injury or death.

### **IMPORTANT SAFETY NOTICE**

There are special components used in this equipment which are important for safety. These parts are marked by  in the Schematic Diagrams, Circuit Board Diagrams, Exploded Views and Replacement Parts List. It is essential that these critical parts should be replaced with manufacturer's specified parts to prevent shock, fire or other hazards. Do not modify the original design without permission of manufacturer.

### **PRECAUTION OF LOW TEMPERATURE**

In order to avoid frostbite, be assured of no refrigerant leakage during the installation or repairing of refrigerant circuit.



# TABLE OF CONTENTS

<b>1. Safety Precautions</b> .....	<b>4</b>
<b>2. Specifications</b> .....	<b>7</b>
2.1 WH-SXC09H3E5 WH-UX09HE5 .....	7
2.2 WH-SXC12H6E5 WH-UX12HE5 .....	10
<b>3. Features</b> .....	<b>13</b>
<b>4. Location of Controls and Components</b> .....	<b>14</b>
4.1 Indoor Unit .....	14
4.2 Outdoor Unit.....	38
<b>5. Dimensions</b> .....	<b>39</b>
5.1 Indoor Unit .....	39
5.2 Outdoor Unit.....	40
<b>6. Refrigeration and Water Cycle Diagram</b> .....	<b>41</b>
6.1 Standard System (Optional PCB not connected) .....	42
6.2 Advance System (Optional PCB connected)...	42
<b>7. Block Diagram</b> .....	<b>43</b>
7.1 WH-SXC09H3E5 WH-UX09HE5 .....	43
7.2 WH-SXC12H6E5 WH-UX12HE5 .....	44
<b>8. Wiring Connection Diagram</b> .....	<b>45</b>
8.1 Indoor Unit .....	45
8.2 Outdoor Unit.....	47
<b>9. Electronic Circuit Diagram</b> .....	<b>48</b>
9.1 Indoor Unit .....	48
9.2 Outdoor Unit.....	50
<b>10. Printed Circuit Board</b> .....	<b>51</b>
10.1 Indoor Unit .....	51
10.2 Outdoor Unit.....	53
<b>11. Installation Instruction</b> .....	<b>55</b>
11.1 Indoor Unit .....	55
11.2 Variation of system .....	62
11.3 System Installation.....	74
11.4 Service and maintenance .....	85
11.5 Outdoor Unit.....	86
<b>12. Operation and Control</b> .....	<b>93</b>
12.1 Basic Function .....	93
12.2 Water Pump .....	107
12.3 Indoor Unit Safety .....	111
12.4 Auto Restart Control .....	111
12.5 Indication Panel .....	111
12.6 Indoor Back-Up Heater Control .....	112
12.7 Tank Heater Control.....	114
12.8 Base Pan Heater Control (Optional).....	116
12.9 Heater Turn ON/OFF priority Control.....	116
12.10 Force Heater Mode .....	117
12.11 Powerful Operation .....	119
12.12 Quiet Operation.....	119
12.13 Sterilization Mode .....	120
12.14 Outdoor Ambient Thermo OFF Control .....	121
12.15 Alternative Outdoor Ambient Sensor Control ..	122
.....	122
12.16 Force DHW mode .....	122
12.17 Anti Freeze Control .....	123
12.18 Solar Operation (Optional).....	124
12.19 Boiler Bivalent Control .....	126
12.20 External Room Thermostat Control (Optional)	128
.....	128
12.21 Three Ways Valve Control .....	129
12.22 Two Ways Valve Control.....	129
12.23 External OFF/ON Control .....	130
12.24 External Compressor Switch (Optional PCB) ..	131
.....	131
12.25 Heat/Cool Switch (Optional PCB).....	132
12.26 SG Ready Control (Optional PCB) .....	133
12.27 Demand Control (Optional PCB) .....	135
12.28 Holiday Mode .....	136
12.29 Dry Concrete .....	136
12.30 Flow Sensor .....	136
<b>13. Protection Control</b> .....	<b>137</b>
13.1 Protection Control for All Operations .....	137
13.2 Protection Control for Heating Operation..	139
13.3 Protection Control for Cooling Operation..	141
<b>14. Servicing Mode</b> .....	<b>142</b>
14.1 How to Take Out Front Plate .....	142
14.2 Test Run .....	142
14.3 Expansion Vessel Pre Pressure Checking .....	142
.....	142
14.4 Pump Down Procedures .....	143
14.5 How To Adjust Pump Speed.....	144
14.6 How To Adjust Pump Speed.....	145
14.7 How To Unlock Cool Mode .....	146
14.8 EEPROM Factory Default Data Setup Procedure .....	147
14.9 Dry Concrete Setup .....	148
<b>15. Maintenance Guide</b> .....	<b>150</b>
15.1 Maintenance for Water Filter Set .....	151
<b>16. Troubleshooting Guide</b> .....	<b>153</b>
16.1 Refrigeration Cycle System .....	153
16.2 Relationship between the Condition of the Air- to-Water Heatpump Indoor and Outdoor Units and Pressure and Electric Current.....	154
16.3 Breakdown Self Diagnosis Function .....	155
16.4 Error Codes Table.....	157
16.5 Self-diagnosis Method .....	159
<b>17. Disassembly and Assembly Instructions</b> ...	<b>211</b>
17.1 To Remove Front Plate.....	211
17.2 To Remove Pressure Gauge .....	211
17.3 To Open Control Board Cover .....	212
17.4 To Remove Control Panel .....	212
17.5 To Remove RCCB .....	213
17.6 To Remove Transformer and Electronic Controller Board.....	213
17.7 To Open Control Board.....	214
17.8 To Remove Pressure Relief Valve, Air Purge Valve and Flow Sensor .....	214
17.9 To Remove Water Pump and Bottle Complete .....	215
17.10 To Remove Filter .....	216



<b>18. Technical Data</b> .....	<b>217</b>
18.1 Operation Characteristics .....	217
18.2 Heating Capacity Table .....	229
18.3 Cooling Capacity Table .....	229
<b>19. Exploded View and Replacement Parts List</b> .....	<b>230</b>
19.1 Indoor Unit .....	230
19.2 Outdoor Unit .....	233

# 1. Safety Precautions





















- Read the following “SAFETY PRECAUTIONS” carefully before installation.
- Electrical work must be installed by a licensed electrician. Be sure to use the correct rating and main circuit for the model to be installed.
- The caution items stated here must be followed because these important contents are related to safety. The meaning of each indication used is as below. Incorrect installation due to ignoring of the instruction will cause harm or damage, and the seriousness is classified by the following indications.
- Please leave this installation manual with the unit after installation.

 <b>WARNING</b>	This indication shows the possibility of causing death or serious injury.
 <b>CAUTION</b>	This indication shows the possibility of causing injury or damage to properties only.

- The items to be followed are classified by the symbols:

	Symbol with white background denotes item that is PROHIBITED from doing.
 	Symbol with dark background denotes item that must be carried out.

- Carry out test run to confirm that no abnormality occurs after the installation. Then, explain to user the operation, care and maintenance as stated in instructions. Please remind the customer to keep the operating instructions for future reference.

 <b>WARNING</b>	
1. Do not use unspecified cord, modified cord, joint cord or extension cord for power supply cord. Do not share the single outlet with other electrical appliances. Poor contact, poor insulation or over current will cause electrical shock or fire.	
2. Do not tie up the power supply cord into a bundle by band. Abnormal temperature rise on power supply cord may happen.	
3. Keep plastic bag (packaging material) away from small children, it may cause suffocation.	
4. Do not use pipe wrench to install refrigerant piping. It might deform the piping and cause the unit to malfunction.	
5. Do not purchase unauthorized electrical parts for installation, service, maintenance and etc. They might cause electrical shock or fire.	
6. Do not modify the wiring of Indoor Unit for installation of other components (i.e. heater, etc). Overloaded wiring or wire connection points may cause electrical shock or fire.	
7. Do not add or replace refrigerant other than specified type. It may cause product damage, burst and injury etc.	
8. Do not use joint cable for Indoor / Outdoor Unit connection cable. Use specified Indoor / Outdoor Unit connection cable, refer to instruction <b>CONNECT THE CABLE TO THE INDOOR UNIT</b> and connect tightly for Indoor / Outdoor Unit connection. Clamp the cable so that no external force will be acted on the terminal. If connection or fixing is not perfect, it will cause heat up or fire at the connection.	
9. Do not install outdoor unit near handrail of veranda. When installing outdoor unit at veranda of high rise building, child may climb up to outdoor unit and cross over the handrail and causing accident.	
10. Do not insert your fingers or other objects into the unit, high speed rotating fan may cause injury. 	
11. Do not sit or step on the unit, you may fall down accidentally. 	
12. For electrical work, follow local wiring standard, regulation and this installation instruction. An independent circuit and single outlet must be used. If electrical circuit capacity is not enough or defect found in electrical work, it will cause electrical shock or fire.	
13. For water circuit installation work, follow to relevant European and national regulations (including EN61770) and local plumbing and building regulation codes.	
14. Engage dealer or specialist for installation. If installation done by the user is defective, it will cause water leakage, electrical shock or fire.	
15. <ul style="list-style-type: none"> <li>• This is a R410A model, when connecting the piping, do not use any existing (R22) pipes and flare nuts. Using such same may cause abnormally high pressure in the refrigeration cycle (piping), and possibly result in explosion and injury. Use only R410A refrigerant.</li> <li>• Thickness or copper pipes used with R410A must be 0.8 mm or more. Never use copper pipes thinner than 0.8 mm.</li> <li>• It is desirable that the amount of residual oil is less than 40mg/10m.</li> </ul>	
16. When install or relocate Indoor Unit / Outdoor Unit, do not let any substance other than the specified refrigerant, e.g. air etc. mix into refrigerant cycle (piping). Mixing of air etc. will cause abnormal high pressure in refrigeration cycle and result in explosion, injury etc..	
17. Install according to this installation instructions strictly. If installation is defective, it will cause water leakage, electrical shock or fire.	







 **WARNING**

18.	Install at a strong and firm location which is able to withstand the set's weight. If the strength is not enough or installation is not properly done, the set will drop and cause injury.	!
19.	This equipment is strongly recommended to be installed with Residual Current Device (RCD) on-site according to the respective national wiring rules or country-specific safety measures in terms of residual current.	!
20.	During installation, install the refrigerant piping properly before run the compressor. Operation of compressor without fixing refrigeration piping and valves at opened condition will cause suck-in of air, abnormal high pressure in refrigeration cycle and result in explosion, injury etc.	!
21.	During pump down operation, stop the compressor before remove the refrigeration piping. Removal of refrigerant piping while compressor is operating and valves are opened will cause suck-in of air, abnormal high pressure in refrigerant cycle and result in explosion, injury etc.	!
22.	Tighten the flare nut with torque wrench according to specified method. If the flare nut is over tightened, after a long period, the flare may break and cause refrigerant gas leakage.	!
23.	After completion of installation, confirm there is no leakage of refrigerant gas. It may generate toxic gas when the refrigerant contacts with fire.	!
24.	Ventilate the room if there is refrigerant gas leakage during operation. Extinguish all fire sources if present. It may cause toxic gas when the refrigerant contacts with fire.	!
25.	Only use the supplied or specified installation parts, else, it may cause unit vibrate loose, water leakage, electrical shock or fire.	!
26.	The unit is only for use in closed water system. Utilization in an open water circuit may lead to excessive corrosion of water piping and risk of incubating bacteria colonies, particularly Legionella, in water.	!
27.	If there is any doubt about the installation procedure or operation, always contact the authorized dealer for advice and information.	!
28.	Select a location where in case of water leakage, the leakage will not cause damage to other properties.	!
29.	When installing electrical equipment at wooden building of metal lath or wire lath, in accordance with electrical facility standard, no electrical contact between equipment and building is allowed. Insulator must be installed in between.	!
30.	Any work carried out on the Indoor Unit / Outdoor Unit after removing any panels which is secured by screws, must be carried out under the supervision of authorized dealer and licensed installation contractor.	!
31.	This unit must be properly earthed. The electrical earth must not be connected to a gas pipe, water pipe, the earth of lightning rod or a telephone. Otherwise there is a danger of electrical shock in the event of an insulation breakdown or electrical earth fault in the outdoor unit.	⚡
32.	Do not use joint cable for outdoor connection cable. Use specified outdoor connection cable, refer to instruction <b>CONNECT THE CABLE TO THE OUTDOOR UNIT</b> and connect tightly for outdoor connection. Clamp the cable so that no external force will be acted on the terminal. If connection or fixing is not perfect, it will cause heat up or fire at the connection.	!

 **CAUTION**

1.	Do not install the Indoor Unit / Outdoor Unit at place where leakage of flammable gas may occur. In case gas leaks and accumulates at surrounding of the unit, it may cause fire.	⊘
2.	Do not release refrigerant during piping work for installation, re-installation and during repairing a refrigeration parts. Take care of the liquid refrigerant, it may cause frostbite.	⊘
3.	Do not install this appliance in a laundry room or other high humidity location. This condition will cause rust and damage to the unit.	⊘
4.	Make sure the insulation of power supply cord does not contact hot part (i.e. refrigerant piping) to prevent from insulation failure (melt).	⊘
5.	Do not apply excessive force to water pipes that may damage the pipes. If water leakage occurs, it will cause flooding and damage to other properties.	⊘
6.	Do not touch the sharp aluminium fin, sharp parts may cause injury. 	⊘
7.	Do not release refrigerant into the atmosphere. The product contains fluorinated greenhouse gases and that its functioning relies upon such gases.	⊘
8.	Select an installation location which is easy for maintenance.	!
9.	Carry out drainage piping as mentioned in installation instructions. If drainage is not perfect, water may enter the room and damage the furniture.	!

 CAUTION

- |   |   |
|---|---|
| <p>Power supply connection to Indoor Unit.</p> <ul style="list-style-type: none"><li>• Power supply point should be in easily accessible place for power disconnection in case of emergency.</li><li>• Must follow local national wiring standard, regulation and this installation instruction.</li><li>• Strongly recommended to make permanent connection to a circuit breaker.<ul style="list-style-type: none"><li>- Power supply 1: Use approved 30A 2-poles circuit breaker with a minimum contact gap of 3.0 mm.</li><li>- Power supply 2: Use approved 30A 2-poles circuit breaker with a minimum contact gap of 3.0 mm.</li></ul></li></ul> |  |
| <p>11. Ensure the correct polarity is maintained throughout all wiring. Otherwise, it will cause electrical shock or fire.</p>  |  |
| <p>12. After installation, check the water leakage condition in connection area during test run. If leakage occurs, it will cause damage to other properties.</p>   |  |
| <p>Installation work.</p> <p>13. It may need two or more people to carry out the installation work. The weight of Indoor Unit / Outdoor Unit might cause injury if carried by one person.</p>   |  |

## 2. Specifications

### 2.1 WH-SXC09H3E5 WH-UX09HE5

Item		Unit	Outdoor Unit		
Performance Test Condition			EN 14511		
Cooling Capacity	Condition (Ambient/Water)		A35W7		
	kW		7.00		
	BTU/h		23900		
	kcal/h		6020		
Cooling EER	W/W		3.17		
	kcal/hW		2.72		
Heating Capacity	Condition (Ambient/Water)		A7W35	A2W35	
	kW		9.00	9.00	
	BTU/h		30700	30700	
	kcal/h		7740	7740	
Heating COP	W/W		4.84	3.59	
	kcal/hW		4.16	3.08	
Heating ErP	Low Temperature Application (W35)		Warmer	Average	Colder
	Application	Climate			
	Pdesign	kW	9.0	9.0	11.0
	Tbivalent / TOL	°C	2 / 2	-10 / -10	-15 / -22
	SCOP / ns	(W/W) / %	5.95 / 235	4.59 / 181	4.08 / 160
	Annual Consumption	kWh	2020	4049	6651
	Class		A++	A++	A++
	Medium Temperature Application (W55)		Warmer	Average	Colder
	Application	Climate			
	Pdesign	kW	9.0	9.0	11.0
	Tbivalent / TOL	°C	2 / 2	-10 / -10	-15 / -22
	SCOP / ns	(W/W) / %	4.02 / 158	3.32 / 130	3.20 / 125
	Annual Consumption	kWh	2991	5596	8468
	Class		A++	A++	A++
Noise Level	Condition (Ambient/Water)		A35W7	A7W35	A2W35
	dB (A)		Cooling: 49	Heating: 51	—
	Power Level dB		Cooling: 67	Heating: 68	—
Air Flow	m <sup>3</sup> /min (ft <sup>3</sup> /min)		Cooling: 89.5 (3160) Heating: 76.8 (2710)		
Refrigeration Control Device			Expansion Valve		
Refrigeration Oil	cm <sup>3</sup>		FV50S (1200)		
Refrigerant (R410A)	kg (oz)		2.85 (100.6)		
F-GAS	GWP		2088		
	CO2eq (ton) (Precharged / Maximum)		5.951 / 8.039		
Dimension	Height	mm (inch)	1340 (52-3/4)		
	Width	mm (inch)	900 (35-7/16)		
	Depth	mm (inch)	320 (12-19/32)		
Net Weight	kg (lbs)		101 (223)		
Pipe Diameter	Liquid	mm (inch)	9.52 (3/8)		
	Gas	mm (inch)	15.88 (5/8)		
Standard Length	m (ft)		7 (23.0)		
Pipe Length Range	m (ft)		3 (9.8) ~ 30 (98.4)		
I/D & O/D Height Difference	m (ft)		20 (65.6)		

Item		Unit	Outdoor Unit		
Additional Gas Amount		g/m (oz/ft)	50 (0.5)		
Refrigeration Charge Less		m (ft)	10 (32.8)		
Compressor	Type		Hermetic Motor		
	Motor Type		Brushless (4-poles)		
	Rated Output	kW	3.00		
Fan	Type		Propeller Fan		
	Material		PP		
	Motor Type		DC (8-poles)		
	Input Power	W	—		
	Output Power	W	60		
Heat Exchanger	Fan Speed	rpm	Cooling: 550 (Top), 590 (Bottom) Heating: 490 (Top), 530 (Bottom)		
	Fin material		Aluminium (Pre Coat)		
	Fin Type		Corrugated Fin		
	Row × Stage × FPI		2 × 51 × 18		
Power Source (Phase, Voltage, Cycle)	Size (W × H × L)	mm	903.7 × 1295.4 × 38.1		
	∅		Single		
	V		230		
Input Power	Hz		50		
	Condition (Ambient/Water)		A35W7	A7W35	A2W35
Maximum Input Power For Heatpump System	kW		Cooling: 2.21	Heating: 1.86	Heating: 2.51
			6.27		
Power Supply 1 : Phase (∅) / Max. Current (A) / Max. Input Power (W)			1∅ / 29.0 / 6.27k		
Power Supply 2 : Phase (∅) / Max. Current (A) / Max. Input Power (W)			1∅ / 13.0 / 3.00k		
Power Supply 3 : Phase (∅) / Max. Current (A) / Max. Input Power (W)			— / — / —		
Starting Current		A	10.2		
Running Current	Condition (Ambient/Water)		A35W7	A7W35	A2W35
	A		Cooling: 10.4	Heating: 8.8	Heating: 11.8
Maximum Current For Heatpump System		A	29.0		
Power Factor Power factor means total figure of compressor and outdoor fan motor.		%	Cooling: 92 Heating: 92		
Power Cord	Number of core		—		
	Length	m (ft)	—		
Thermostat			Electronic Control		
Protection Device			Electronic Control		

Item		Unit	Indoor Unit		
Performance Test Condition			EN 14511		
Operation Range	Outdoor Ambient	°C	Cooling: 16 ~ 43 Heating: -28 ~ 35		
	Water Outlet	°C	Cooling: 5 ~ 20 Heating: 20 ~ 55 (Below Ambient -15°C) 20 ~ 60 (Below Ambient -10°C)		
Internal Pressure Differential		kPa	Cooling: 20 Heating: 30		
Noise Level		Condition (Ambient/Water)	A35W7	A7W35	A2W35
		dB (A)	Cooling: 33	Heating: 33	—
		Power Level dB	Cooling: 46	Heating: 46	—
Dimension	Height	mm (inch)	892 (35-1/8)		
	Width	mm (inch)	500 (19-11/16)		
	Depth	mm (inch)	340 (13-13/32)		
Net Weight		kg (lbs)	43 (95)		
Refrigerant Pipe Diameter	Liquid	mm (inch)	9.52 (3/8)		
	Gas	mm (inch)	15.88 (5/8)		
Water Pipe Diameter	Inlet	mm (inch)	28 (1-3/32)		
	Outlet	mm (inch)	28 (1-3/32)		
Water Drain Hose Inner Diameter		mm (inch)	15 (19/32)		
Pump	Motor Type		DC Motor		
	No. of Speed		7 (Software Selection)		
	Input Power	W	58		
Hot Water Coil	Type		Brazed Plate		
	No. of Plates		36		
	Size (W × H × L)	mm	65 × 119 × 376		
	Water Flow Rate	l/min (m <sup>3</sup> /h)	Cooling: 20.1 (1.2) Heating: 25.8 (1.5)		
Pressure Relief Valve Water Circuit		kPa	Open: 300, Close: 266 and below		
Flow Switch			Electronic Sensor		
Protection Device		A	Residual Current Circuit Breaker (40)		
Expansion Vessel	Volume	l	10		
	MWP	bar	3		
Capacity of Integrated Electric Heater		kW	3.00		

**Note:**

- Cooling capacities are based on outdoor air temperature of 35°C Dry Bulb with controlled indoor water inlet temperature of 12°C and water outlet temperature of 7°C.
- Heating capacities are based on outdoor air temperature of 7°C Dry Bulb (44.6°F Dry Bulb), 6°C Wet Bulb (42.8°F Wet Bulb) with controlled indoor water inlet temperature of 30°C and water outlet temperature of 35°C.
- Specification are subjected to change without prior notice for further improvement.
- Flow rate indicated are based on nominal capacity adjustment of leaving water temperature (LWT) 35°C and  $\Delta T = 5^\circ\text{C}$ .

## 2.2 WH-SXC12H6E5 WH-UX12HE5

Item		Unit	Outdoor Unit		
Performance Test Condition			EN 14511		
Cooling Capacity	Condition (Ambient/Water)		A35W7		
	kW		10.00		
	BTU/h		34100		
	kcal/h		8600		
Cooling EER	W/W		2.81		
	kcal/hW		2.42		
Heating Capacity	Condition (Ambient/Water)		A7W35	A2W35	
	kW		12.00	12.00	
	BTU/h		41000	41000	
	kcal/h		10320	10320	
Heating COP	W/W		4.74	3.44	
	kcal/hW		4.08	2.96	
Heating ErP	Low Temperature Application (W35)		Warmer	Average	Colder
	Application	Climate			
	Pdesign	kW	12.0	12.0	14.0
	Tbivalent / TOL	°C	2 / 2	-10 / -10	-15 / -22
	SCOP / ns	(W/W) / %	5.86 / 231	4.32 / 170	4.08 / 160
	Annual Consumption	kWh	2738	5745	8460
	Class		A++	A++	A++
	Medium Temperature Application (W55)		Warmer	Average	Colder
	Application	Climate			
	Pdesign	kW	12.0	12.0	13.0
	Tbivalent / TOL	°C	2 / 2	-10 / -10	-15 / -22
	SCOP / ns	(W/W) / %	4.02 / 158	3.32 / 130	3.20 / 125
	Annual Consumption	kWh	3990	7466	10012
	Class		A++	A++	A++
Noise Level	Condition (Ambient/Water)		A35W7	A7W35	A2W35
	dB (A)		Cooling: 50	Heating: 52	—
	Power Level dB		Cooling: 68	Heating: 69	—
Air Flow	m <sup>3</sup> /min (ft <sup>3</sup> /min)		Cooling: 93.3 (3290) Heating: 80.0 (2830)		
Refrigeration Control Device			Expansion Valve		
Refrigeration Oil	cm <sup>3</sup>		FV50S (1200)		
Refrigerant (R410A)	kg (oz)		2.85 (100.6)		
F-GAS	GWP		2088		
	CO <sub>2</sub> eq (ton) (Precharged / Maximum)		5.951 / 8.039		
Dimension	Height	mm (inch)	1340 (52-3/4)		
	Width	mm (inch)	900 (35-7/16)		
	Depth	mm (inch)	320 (12-19/32)		
Net Weight	kg (lbs)		101 (223)		
Pipe Diameter	Liquid	mm (inch)	9.52 (3/8)		
	Gas	mm (inch)	15.88 (5/8)		
Standard Length	m (ft)		7 (23.0)		
Pipe Length Range	m (ft)		3 (9.8) ~ 30 (98.4)		
I/D & O/D Height Difference	m (ft)		20 (65.6)		
Additional Gas Amount	g/m (oz/ft)		50 (0.5)		
Refrigeration Charge Less	m (ft)		10 (32.8)		

Item		Unit	Outdoor Unit		
Compressor	Type		Hermetic Motor		
	Motor Type		Brushless (4-poles)		
	Rated Output	kW	3.00		
Fan	Type		Propeller Fan		
	Material		PP		
	Motor Type		DC (8-poles)		
	Input Power	W	—		
	Output Power	W	60		
	Fan Speed	rpm	Cooling: 600 (Top), 640 (Bottom) Heating: 520 (Top), 560 (Bottom)		
Heat Exchanger	Fin material		Aluminium (Pre Coat)		
	Fin Type		Corrugated Fin		
	Row × Stage × FPI		2 × 51 × 18		
	Size (W × H × L)	mm	903.7 × 1295.4 × 38.1		
Power Source (Phase, Voltage, Cycle)	∅		Single		
	V		230		
	Hz		50		
Input Power	Condition (Ambient/Water)		A35W7	A7W35	A2W35
	kW		Cooling: 3.56	Heating: 2.53	Heating: 3.49
Maximum Input Power For Heatpump System	kW		6.27		
Power Supply 1 : Phase (∅) / Max. Current (A) / Max. Input Power (W)			1∅ / 29.0 / 6.27k		
Power Supply 2 : Phase (∅) / Max. Current (A) / Max. Input Power (W)			1∅ / 26.0 / 6.00k		
Power Supply 3 : Phase (∅) / Max. Current (A) / Max. Input Power (W)			— / — / —		
Starting Current	A		16.5		
Running Current	Condition (Ambient/Water)		A35W7	A7W35	A2W35
	A		Cooling: 16.5	Heating: 11.7	Heating: 16.1
Maximum Current For Heatpump System	A		29.0		
Power Factor Power factor means total figure of compressor and outdoor fan motor.	%		Cooling: 94	Heating: 94	Heating: 94
Power Cord	Number of core		—		
	Length	m (ft)	—		
Thermostat			Electronic Control		
Protection Device			Electronic Control		

Item		Unit	Indoor Unit		
Performance Test Condition			EN 14511		
Operation Range	Outdoor Ambient	°C	Cooling: 16 ~ 43 Heating: -28 ~ 25		
	Water Outlet	°C	Cooling: 5 ~ 20 Heating: 20 ~ 55 (Below Ambient -15°C) 20 ~ 60 (Below Ambient -10°C)		
Internal Pressure Differential		kPa	Cooling: 36 Heating: 52		
Noise Level		Condition (Ambient/Water)	A35W7	A7W35	A2W35
		dB (A)	Cooling: 33	Heating: 33	—
		Power Level dB	Cooling: 46	Heating: 46	—
Dimension	Height	mm (inch)	892 (35-1/8)		
	Width	mm (inch)	500 (19-11/16)		
	Depth	mm (inch)	340 (13-13/32)		
Net Weight		kg (lbs)	43 (95)		
Refrigerant Pipe Diameter	Liquid	mm (inch)	9.52 (3/8)		
	Gas	mm (inch)	15.88 (5/8)		
Water Pipe Diameter	Inlet	mm (inch)	28 (1-3/32)		
	Outlet	mm (inch)	28 (1-3/32)		
Water Drain Hose Inner Diameter		mm (inch)	15 (19/32)		
Pump	Motor Type		DC Motor		
	No. of Speed		7 (Software Selection)		
	Input Power	W	92		
Hot Water Coil	Type		Brazen Plate		
	No. of Plates		36		
	Size (W × H × L)	mm	65 × 119 × 376		
	Water Flow Rate	l/min (m <sup>3</sup> /h)	Cooling: 28.7 (1.7) Heating: 34.4 (2.1)		
Pressure Relief Valve Water Circuit		kPa	Open: 300, Close: 266 and below		
Flow Switch			Electronic Sensor		
Protection Device		A	Residual Current Circuit Breaker (40)		
Expansion Vessel	Volume	l	10		
	MWP	bar	3		
Capacity of Integrated Electric Heater		kW	6.00		

**Note:**

- Cooling capacities are based on outdoor air temperature of 35°C Dry Bulb with controlled indoor water inlet temperature of 12°C and water outlet temperature of 7°C.
- Heating capacities are based on outdoor air temperature of 7°C Dry Bulb (44.6°F Dry Bulb), 6°C Wet Bulb (42.8°F Wet Bulb) with controlled indoor water inlet temperature of 30°C and water outlet temperature of 35°C.
- Specification are subjected to change without prior notice for further improvement.
- Flow rate indicated are based on nominal capacity adjustment of leaving water temperature (LWT) 35°C and  $\Delta T = 5^\circ\text{C}$ .



### 3. Features

- **Inverter Technology**
  - Energy saving
- **High Efficiency**
- **Environment Protection**
  - Non-ozone depletion substances refrigerant (R410A)
- **Long Installation Piping**
  - Long piping up to 30 meter with height difference 20 meter
  - Flexible 4-way piping for outdoor unit
- **Easy to use control panel**
  - Auto mode
  - Holiday mode
  - Dry concrete function
  - Weekly timer setting
- **A-class energy efficiency pump**
  - Water pump speed can be set by selection at control panel
- **Improved deice cycle**
- **Protection Feature**
  - Random auto restart after power failure for safety restart operation
  - Gas leakage protection
  - Prevent compressor reverse cycle
  - Inner protector to protect compressor
- **Serviceability Feature**
  - Breakdown Self Diagnosis function
  - System Status Check Buttons for servicing purpose
  - System Pumpdown Button for servicing purpose
  - Front maintenance design for outdoor unit

## 4. Location of Controls and Components

### 4.1 Indoor Unit

#### 4.1.1 Location of Control

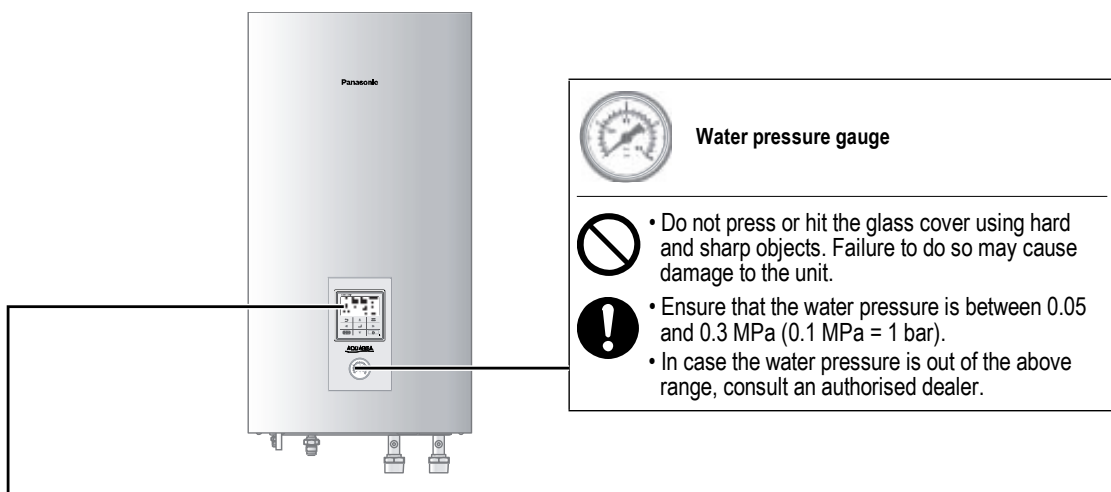

#### Buttons / Indicator

- ① **Quick Menu button**  
(For more details, refer to the separate Quick Menu Guide.)
- ② **Back button**  
Returns to the previous screen
- ③ **LCD Display**
- ④ **Main Menu button**  
For function setup
- ⑤ **ON/OFF button**  
Starts/Stops operation
- ⑥ **Operation indicator**  
Illuminates during operation, blinks during alarm.

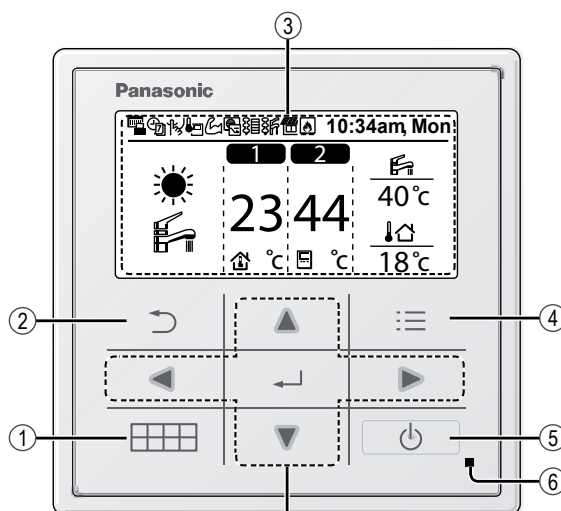

#### Cross key buttons

Selects an item.

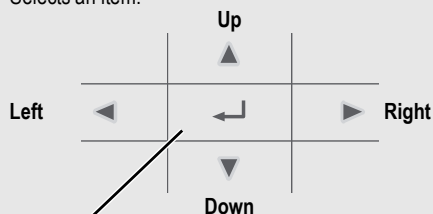

#### Enter button

Fixes the selected content.

! Press centre

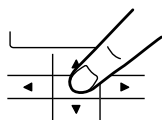

⊘ No glove

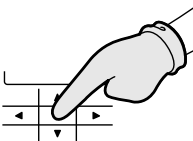

⊘ No pen

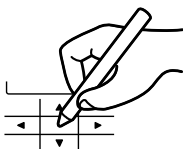

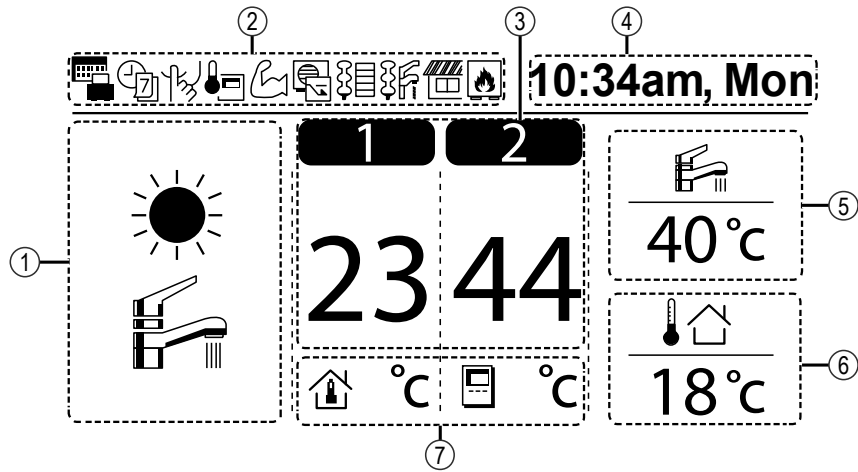

## Display

### ① Mode selection

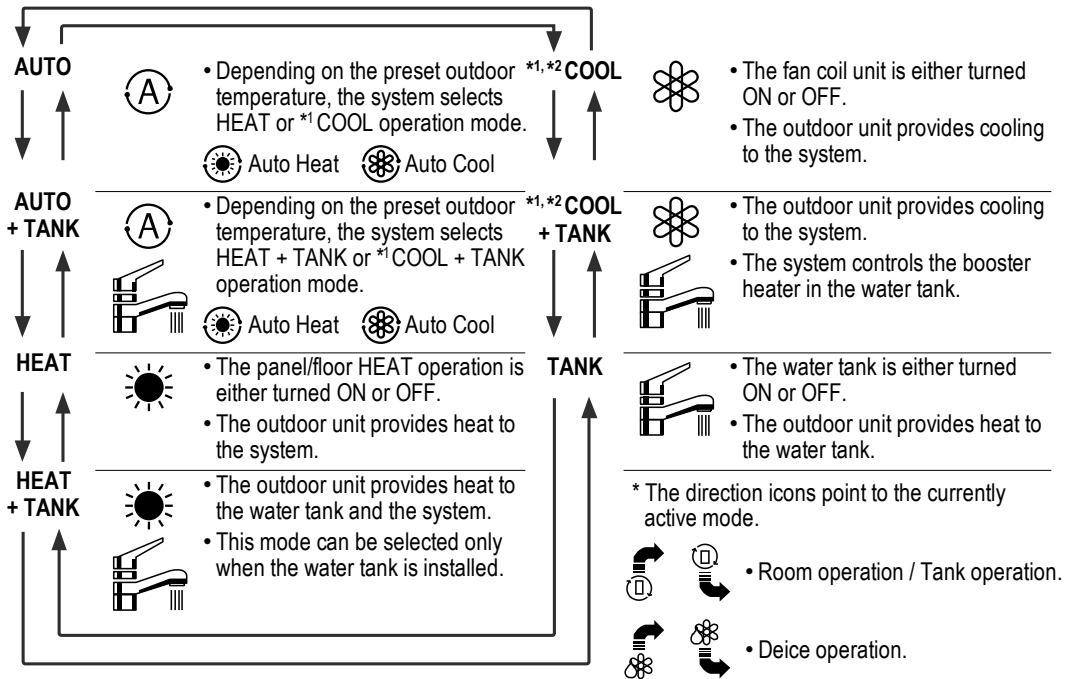

### ② Operation icons

The status of operation is displayed. Icon will not display (under operation OFF screen) whenever operation is OFF except weekly timer.

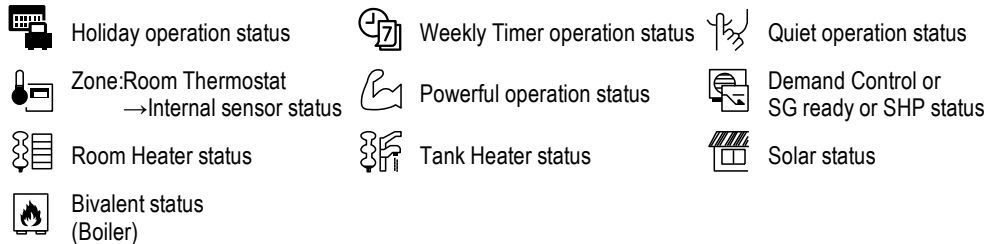

\*1 The system is locked to operate without COOL mode. It can be unlocked only by authorised installers or our authorised service partners.

\*2 Only displayed when COOL mode is unlocked (This means when COOL mode is available).

### ③ Temperature of each zone

### ④ Time and day

### ⑤ Water Tank temperature

### ⑥ Outdoor temperature

### ⑦ Sensor type/Set temperature type icons



## 4.1.2 Initialization

Before starting to install the various menu settings, please initiate the Remote Controller by selecting the language of operation and installing the date and time correctly. It is recommended that the installer conducts the following initialization of the Remote Controller.





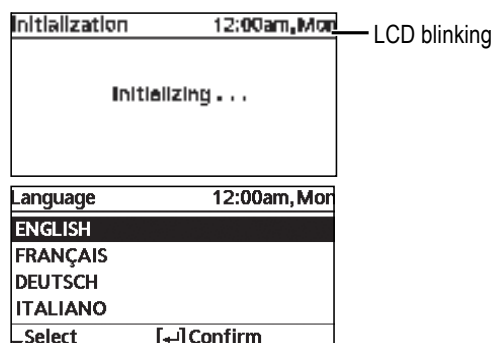

### Selecting the language

Press  and wait while the display is initializing.

- ① Scroll with  and  to select the language.
- ② Press  to confirm the selection.



### Setting the clock

- ① Select with  or  how to display the time, either 24h or am/pm format (for example, 15:00 or 3 pm).
- ② Press  to confirm the selection.
- ③ Use  and  to select year, month, day, hour and minutes. (Press  to confirm the selection each time.)
- ④ Once the time is set, time and day will appear on the display even if the Remote Controller is turned OFF.

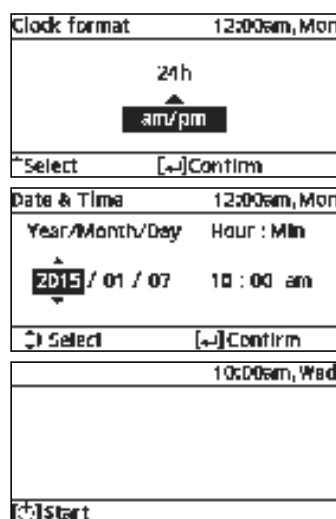

## 4.1.3 Quick Menu

After the initial settings have been completed, you can select a quick menu from the following options and edit the setting.

- ① Press  to display the quick menu.

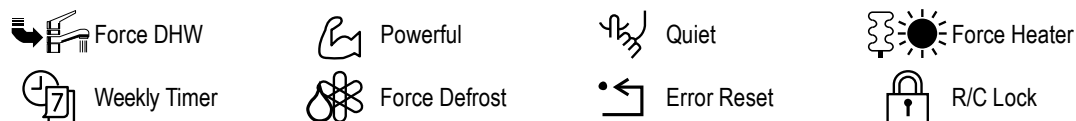
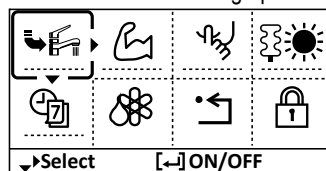

- ② Use     to select menu.
- ③ Press  to turn on/off the select menu.

### 4.1.3.1 Before Use

This Quick Guide explains how to use the Quick Menu.  
Please read the Operating Instructions thoroughly before using the Quick Menu.

### 4.1.3.2 How to use the Quick Menu

After the initial settings have been completed, you can select a quick menu from the following options and edit the setting.

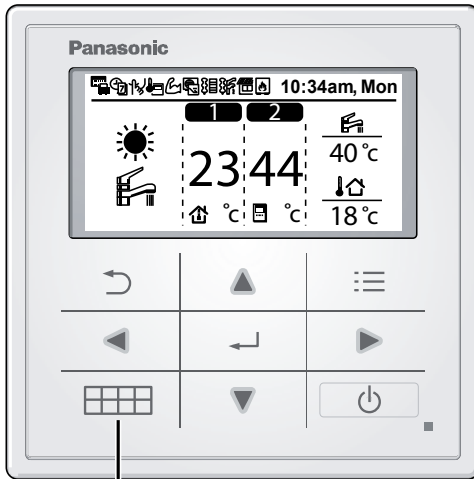

① Press .

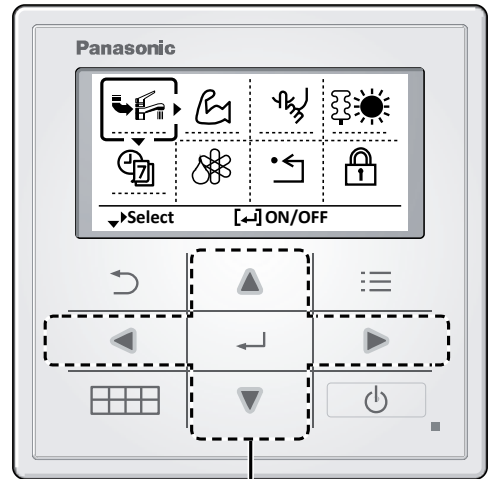

② Use to select menu.

③ Press to turn on/off the select menu.

## Quick Menu

<b>Force DHW</b>	<b>Powerful</b>	<b>Quiet</b>	<b>Force Heater</b>
<b>Weekly Timer</b>	<b>Force Defrost</b>	<b>Error Reset</b>	<b>R/C Lock</b>

**Select**
 **ON/OFF**

Select each setting and confirm the setting according to the instructions displayed at the bottom of the screen. (The icons refer to each selection key.)

**To return to the Main Screen,**

Press or .

■ **Note:**

- If the system is not connected to the tank (Tank Connection is OFF), the Quick Menu screen will be displayed as right. Make sure the Tank Connection is ON.

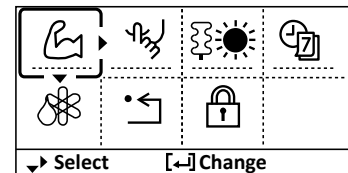

## Notes on operation icon

Example:



• Operation icon indicate with “.....” = OFF



• Operation icon indicate with “———” = ON

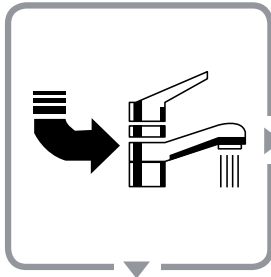

## Force DHW

Select this icon to turn the Tank DHW on or off.

Press  to confirm your selection.

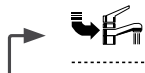

• Force DHW is turned off.

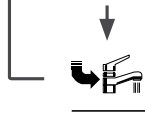

• Force DHW is turned on.

### ■ Note:

- Force DHW is disabled when Force Heater is turned on.
- When Force DHW is turned off, operation & mode should change back to the previous memorized status.

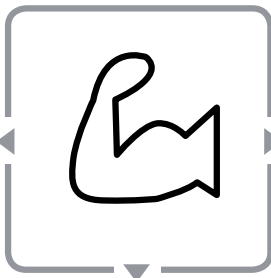

## Powerful

Select this icon to operate the heating/cooling system powerfully.

Press  to confirm your selection.

(The powerful operation starts approximately 1 minute after  is pressed.)



• Powerful mode is set off.



• The Powerful mode operates for 30 minutes.



• The Powerful mode operates for 60 minutes.



• The Powerful mode operates for 90 minutes.

### ■ Note:

- Powerful is disabled when operation is turned OFF.

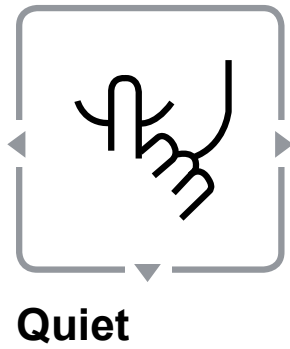

Select this icon to operate quietly.

Press to confirm your selection.

(The quiet operation starts approximately 1 minute after is pressed.)

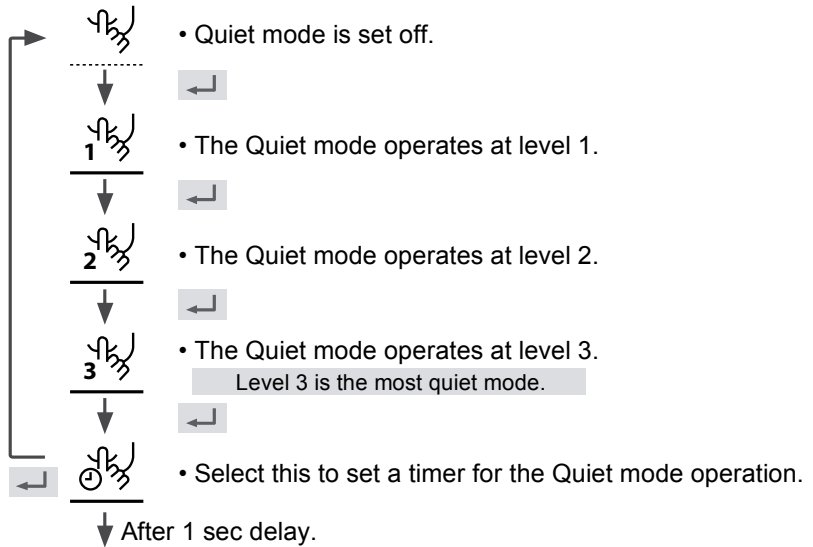

Do you want to edit Quiet timer pattern?

Yes No

Pattern	Time	Level
1.	6:00	2
2.	9:00	1
3.	10:00	0

Edit  
Delete

6 : 00 am

Set time is overlapped!  
[Close]

**Select "Yes".**

- Select "Yes" using buttons.

**Select pattern "1" ~ "6".**

**Select "Edit".**

- If you select "Delete", the timer setting of the selected pattern will be deleted.

**Set the hour and minutes.**

**Select the level of Quiet.**

**Note:**

- If the time overlaps with another pattern, "Set time is overlapped!" will appear on the screen.

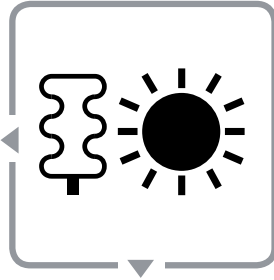

## Force Heater

### Select to force the Heater on.

Press  to confirm your selection.

(The Force Heater mode starts approximately 1 minute after  is pressed.)

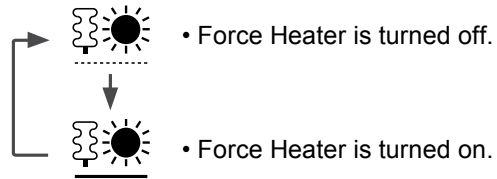

#### ■ Note:

- Force Heater is disabled whenever operation is already on and 'Disabled due to Operation ON!' will be displayed.

Disabled due to  
Operation ON!

 Close





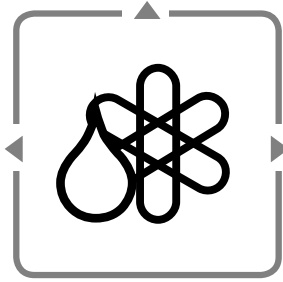

## Force Defrost

Select to defrost the frozen pipes.

Press to confirm your selection.

(When the mode is accepted, below screen will be displayed.)

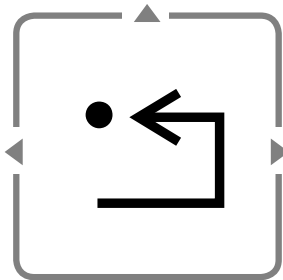
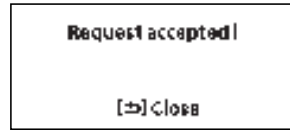

## Error Reset

Select to restore the previous settings when error has occurred.

Press to confirm your selection.

(When the mode has been accepted, below screen will be displayed.)

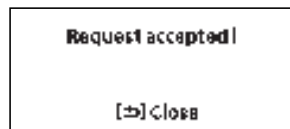

- Make sure all units are turned off before selecting this mode which restores the whole system to the previous settings.

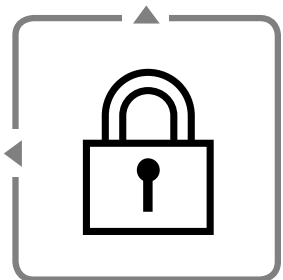

## R/C Lock

Select to lock the Remote Controller.

Press to confirm your selection.

(When the mode has been accepted, below screen will be displayed.)

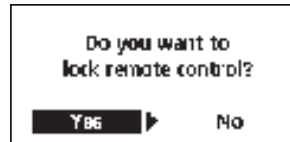

Select "Yes".

(The Main Screen will be locked.)

- If "No" is selected, the screen will return to the Main Screen.

### To unlock the Remote Controller

Press any key.

(When the mode has been accepted, below screen will be displayed.)



Enter any 4 digits of number (if the number is correct, the screen will be unlocked).

### To reset forgotten password (under operation OFF screen)

Press , and continuously for 5 seconds.

(When the mode has been accepted, below screen will be displayed.)



Select "Reset".



(The screen will be off after 3 seconds.)

## 4.1.4 Menus For user

Select menus and determine settings according to the system available in the household. All initial settings must be done by an authorised dealer or a specialist. It is recommended that all alterations of the initial settings are also done by an authorised dealer or a specialist.

- After initial installation, you may manually adjust the settings.
- The initial setting remains active until the user changes it.
- The Remote Controller can be used for multiple installations.
- Ensure the operation indicator is OFF before setting.
- The system may not work properly if set wrongly.  
Please consult an authorised dealer.







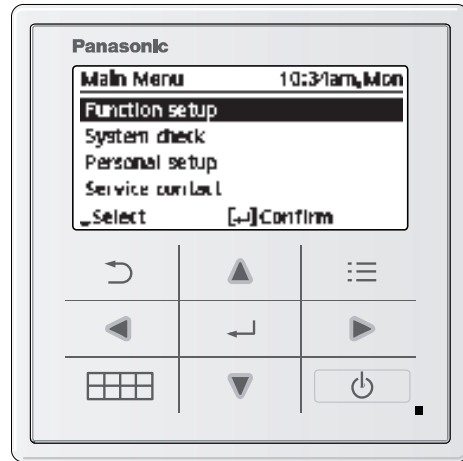





To display <Main Menu>: 





To select menu:    

To confirm the selected content: 



Menu	Default Setting	Setting Options / Display																																
<b>1 Function setup</b>																																		
<b>1.1 &gt; Weekly timer</b>																																		
<p>Once the weekly timer is set up, User can edit from Quick Menu.</p> <p>To set up to 6 patterns of operation on a weekly basis.</p> <ul style="list-style-type: none"> <li>• Disabled if Heat-Cool SW is pressed or if Force Heater is on.</li> </ul>	<p><b>Timer setup</b> Select day of the week and set the patterns needed (Time / Operation ON/OFF / Mode)</p> <p><b>Timer copy</b> Select day of the week</p>	<p><b>Weekly timer</b> 10:34am, Mon</p> <table border="1"> <thead> <tr> <th></th> <th>Sun</th> <th>Mon</th> <th>Tue</th> <th>Wed</th> <th>Thu</th> <th>Fri</th> <th>Sat</th> </tr> </thead> <tbody> <tr> <td>1. 8:00am ON</td> <td></td> <td></td> <td></td> <td></td> <td></td> <td></td> <td>40°C</td> </tr> <tr> <td>2. 12:00pm ON</td> <td></td> <td></td> <td></td> <td>☀️</td> <td>24/28°C</td> <td></td> <td>40°C</td> </tr> <tr> <td>3. 1:00pm ON</td> <td></td> <td></td> <td></td> <td>☀️</td> <td>12/10°C</td> <td></td> <td></td> </tr> </tbody> </table> <p>↔Day    ↘Pattern    [↔]Edit</p>		Sun	Mon	Tue	Wed	Thu	Fri	Sat	1. 8:00am ON							40°C	2. 12:00pm ON				☀️	24/28°C		40°C	3. 1:00pm ON				☀️	12/10°C		
	Sun	Mon	Tue	Wed	Thu	Fri	Sat																											
1. 8:00am ON							40°C																											
2. 12:00pm ON				☀️	24/28°C		40°C																											
3. 1:00pm ON				☀️	12/10°C																													

Menu	Default Setting	Setting Options / Display															
<b>1.2 &gt; Holiday timer</b>																	
To save energy, a holiday period may be set to either turn OFF the system or lower the temperature during the period.	OFF																
	> ON	<table border="1"> <tr> <td colspan="2">Holiday start and end. Date and time</td> <td>Holiday: End</td> <td>10:34am, Mon</td> </tr> <tr> <td>Year/Month/Day</td> <td>Hour : Min</td> <td></td> <td></td> </tr> <tr> <td>2015 / 01 / 01</td> <td>10 : 00 am</td> <td></td> <td></td> </tr> <tr> <td colspan="2">OFF or lowered temperature</td> <td></td> <td></td> </tr> </table>	Holiday start and end. Date and time		Holiday: End	10:34am, Mon	Year/Month/Day	Hour : Min			2015 / 01 / 01	10 : 00 am			OFF or lowered temperature		
Holiday start and end. Date and time		Holiday: End	10:34am, Mon														
Year/Month/Day	Hour : Min																
2015 / 01 / 01	10 : 00 am																
OFF or lowered temperature																	
<ul style="list-style-type: none"> <li>Weekly timer setting may be temporarily disabled during Holiday timer setting but it will be restored once the Holiday timer is completed.</li> </ul>																	
<b>1.3 &gt; Quiet timer</b>																	
To operate quietly during the preset period. 6 patterns may be set. Level 0 means the mode is off.	Time to start Quiet : Date and time	<table border="1"> <tr> <td>Quiet</td> <td>10:34am, Mon</td> </tr> <tr> <td>Pattern</td> <td>Time</td> </tr> <tr> <td>1</td> <td>8:00am 0</td> </tr> <tr> <td>2</td> <td>5:00pm 1</td> </tr> <tr> <td>3</td> <td>11:00pm 3</td> </tr> </table>	Quiet	10:34am, Mon	Pattern	Time	1	8:00am 0	2	5:00pm 1	3	11:00pm 3					
	Quiet	10:34am, Mon															
Pattern	Time																
1	8:00am 0																
2	5:00pm 1																
3	11:00pm 3																
Level of quietness: 0 ~ 3																	
<b>1.4 &gt; Room heater</b>																	
To set the room heater ON or OFF.	OFF																
<b>1.5 &gt; Tank heater</b>																	
To set the tank heater ON or OFF.	OFF																
<ul style="list-style-type: none"> <li>Available only if connected to the tank.</li> </ul>																	
<b>1.6 &gt; Sterilization</b>																	
To set the auto sterilization ON or OFF.	OFF																
<ul style="list-style-type: none"> <li>Available only if connected to the tank.</li> <li>Do not use the system during sterilization in order to prevent scalding with hot water, or overheating of shower.</li> <li>Ask an authorised dealer to determine the level of sterilization function field settings according to the local laws and regulations.</li> </ul>																	
<b>2 System check</b>																	
<b>2.1 &gt; Energy monitor</b>																	
Present or historical chart of energy consumption, generation or COP.	Present Select and retrieve	<table border="1"> <tr> <td colspan="2">Total consumption (1year)</td> </tr> <tr> <td>0.0 kWh</td> <td></td> </tr> <tr> <td colspan="2">  </td> </tr> <tr> <td colspan="2">           1year 1 2 3 4 5 6 7 8 9 10 11 12 kWh         </td> </tr> <tr> <td colspan="2">           Jan, 2015: 0.0 kWh <span>Approx.</span> </td> </tr> <tr> <td colspan="2">  </td> </tr> </table>	Total consumption (1year)		0.0 kWh				1year 1 2 3 4 5 6 7 8 9 10 11 12 kWh		Jan, 2015: 0.0 kWh <span>Approx.</span>						
	Total consumption (1year)																
0.0 kWh																	
																	
1year 1 2 3 4 5 6 7 8 9 10 11 12 kWh																	
Jan, 2015: 0.0 kWh <span>Approx.</span>																	
																	
Historical chart Select and retrieve																	
<ul style="list-style-type: none"> <li>COP= Coefficient of Performance.</li> <li>For historical chart, the period is selected from 1 day/1 week/1year.</li> <li>Energy consumption (kWh) of heating,*1 cooling, tank and total may be retrieved.</li> <li>The total power consumption is an estimated value based on AC 230 V and may differ from value measured by precise equipment.</li> </ul>																	
<b>2.2 &gt; Water temperatures</b>																	
Shows all water temperatures in each area.	Actual water temperature of 8 items: Inlet / Outlet / Zone 1 / Zone 2 / Tank / Buffer tank / Solar / Pool  Select and retrieve	<table border="1"> <tr> <td colspan="2">Water temperatures</td> <td>10:34am, Mon</td> </tr> <tr> <td>1. Inlet</td> <td>:</td> <td>0°C</td> </tr> <tr> <td>2. Outlet</td> <td>:</td> <td>0°C</td> </tr> <tr> <td>3. Zone 1</td> <td>:</td> <td>0°C</td> </tr> <tr> <td>4. Zone 2</td> <td>:</td> <td>0°C</td> </tr> </table> 	Water temperatures		10:34am, Mon	1. Inlet	:	0°C	2. Outlet	:	0°C	3. Zone 1	:	0°C	4. Zone 2	:	0°C
Water temperatures		10:34am, Mon															
1. Inlet	:	0°C															
2. Outlet	:	0°C															
3. Zone 1	:	0°C															
4. Zone 2	:	0°C															
<p>*1 The system is locked to operate without COOL mode. It can be unlocked only by authorised installers or our authorised service partners.</p> <p>*2 Only displayed when COOL mode is unlocked (This means when COOL mode is available).</p>																	

Menu	Default Setting	Setting Options / Display
<b>2.3 &gt; Error history</b>		
<ul style="list-style-type: none"> <li>Refer to Troubleshooting for error codes.</li> <li>The most recent error code is displayed at the top.</li> </ul>	Select and retrieve	Error history 10:34am, Mon 1. -- 2. -- 3. -- 4. -- [←] Clear history
<b>2.4 &gt; Compressor</b>		
Shows the compressor performance.	Select and retrieve	Compressor 10:34am, Mon 1. Current frequency : 0 Hz 2. (OFF-ON) counter : 0 3. Total ON time : 0 h [→] Back
<b>2.5 &gt; Heater</b>		
Total hours of ON time for Room heater/Tank heater.	Select and retrieve	Heater 10:34am, Mon Total ON time  : 0h  : 0h [→] Back
<b>3 Personal setup</b>		
<b>3.1 &gt; Touch sound</b>		
Turns the operation sound ON/OFF.	ON	ON ▼ OFF
<b>3.2 &gt; LCD contrast</b>		
Sets the screen contrast.	3	LCD contrast 10:34am, Mon Low High  [←] Select [→] Confirm
<b>3.3 &gt; Backlight</b>		
Sets the duration of screen backlight.	1 min	Backlight 10:34am, Mon OFF 5 mins 15 secs 10 mins 1 min [←] Select [→] Confirm
<b>3.4 &gt; Backlight intensity</b>		
Sets screen backlight brightness.	4	Backlight intensity 10:34am, Mon Dark Bright  [←] Select [→] Confirm
<b>3.5 &gt; Clock format</b>		
Sets the type of clock display.	24h	Clock format 10:34am, Mon 24h am/pm [←] Select [→] Confirm

Menu	Default Setting	Setting Options / Display
<b>3.6 &gt; Date &amp; Time</b>		
Sets the present date and time.	Year / Month / Day / Hour / Min	<p>Date &amp; Time 10:34am, Mon</p> <p>Year/Month/Day Hour : Min</p> <p>2015 / 01 / 07 10 : 00 am</p> <p>↔ Select [←] Confirm</p>
<b>3.7 &gt; Language</b>		
Sets the display language for the top screen. <ul style="list-style-type: none"> <li>• For Dutch, Greek, Finnish and Turkish, please refer to the English version.</li> </ul>	ENGLISH / FRANÇAIS / DEUTSCH / ITALIANO / ESPAÑOL / DANISH / SWEDISH / NORWEGIAN / POLISH / CZECH	<p>Language 10:34am, Mon</p> <p><b>ENGLISH</b></p> <p>FRANÇAIS            DEUTSCH            ITALIANO</p> <p>↕ Select [←] Confirm</p>
<b>3.8 &gt; Unlock password</b>		
4 digit password for all the settings.	0000	<p>Unlock password 10:34am, Mon</p> <p>0000</p> <p>↕ Select [←] Confirm</p>
<b>4 Service contact</b>		
<b>4.1 &gt; Contact 1 / Contact 2</b>		
Preset contact number for installer.	Select and retrieve	<p>Service setup 10:34am, Mon</p> <p>Contact 1</p> <p>Name : Bryan Adams</p> <p>☎ : 08812945878</p> <p>↕ Select</p>

## 4.1.5 Menus For installer

Menu	Default Setting	Setting Options / Display
<b>5 Installer setup &gt; System setup</b>		
<b>5.1 &gt; Optional PCB connectivity</b>		
To connect to the external PCB required for servicing.	No	<div style="text-align: right;">                     Yes                      ▼                      No                 </div>
<ul style="list-style-type: none"> <li>If the external PCB is connected (optional), the system will have following additional functions:                             <ol style="list-style-type: none"> <li>① Buffer tank connection and control over its function and temperature.</li> <li>② Control over 2 zones (including the swimming pool and the function to heat water in it).</li> <li>③ Solar function (the solar thermal panels connected to either the DHW (Domestic Hot Water) Tank or the Buffer Tank).</li> <li>④ External compressor switch.</li> <li>⑤ External error signal.</li> <li>⑥ SG ready control.</li> <li>⑦ Demand control.</li> <li>⑧ Heat-Cool SW</li> </ol> </li> </ul>		
<b>5.2 &gt; Zone &amp; Sensor</b>		
To select the sensors and to select either 1 zone or 2 zone system.	<b>Zone</b> <ul style="list-style-type: none"> <li>After selecting 1 or 2 zone system, proceed to the selection of room or swimming pool.</li> <li>If the swimming pool is selected, the temperature must be selected for <math>\Delta T</math> temperature between 2 °C ~10 °C.</li> </ul>	<div style="text-align: right;">                     Zone &amp; Sensor 10:34am, Mon                      Zone                      1 Zone system                      2 Zones system                      Select Confirm                 </div>
	<b>Sensor</b> <ul style="list-style-type: none"> <li>* For room thermostat, there is a further selection of external or internal.</li> </ul>	<div style="text-align: right;">                     Zone &amp; Sensor 10:34am, Mon                      Sensor                      Water temperature                      Room thermostat                      Room thermostat                      Select Confirm                 </div>
<b>5.3 &gt; Heater capacity</b>		
To reduce the heater power if unnecessary.* 3 kW / 6 kW / 9 kW	3 kW or 9 kW*	<div style="text-align: right;">                     Heater capacity 10:34am, Mon                      3 kW                      6 kW                      9 kW                      Select Confirm                 </div>
* Options of kW vary depending on the model.		
<b>5.4 &gt; Anti freezing</b>		
To activate or deactivate the water freeze prevention when the system is OFF.	Yes	<div style="text-align: right;">                     Yes                      ▼                      No                 </div>
<b>5.5 &gt; Tank connection</b>		
To connect tank to the system.	No	<div style="text-align: right;">                     Yes                      ▲                      No                 </div>
<b>5.6 &gt; Buffer tank connection</b>		
To connect tank to the system and if selected YES, to set $\Delta T$ temperature.	No	<div style="text-align: right;">                     Yes                      ▲                      No                 </div>
<b>&gt; Yes</b>		
<ul style="list-style-type: none"> <li>The optional PCB connectivity must be selected YES to enable the function.</li> <li>If the optional PCB connectivity is not selected, the function will not appear on the display.</li> </ul>	5 °C	<div style="text-align: right;">                     Buffer Tank 10:34am, Mon  <math>\Delta T</math> for Buffer Tank                      Range: (0°C~10°C)                      Steps: <math>\pm 1^\circ\text{C}</math>                      5 °C                      Select Confirm                 </div>

Menu	Default Setting	Setting Options / Display
<b>5.7 &gt; Tank heater</b>		
<p>To select external or internal tank heater and if External is selected, set a timer for the heater to come on.</p> <p>* This option is available if Tank connection is selected (YES).</p>	Internal	<p>Tank heater 10:34am, Mon</p> <p>External</p> <p>Internal</p> <p>Select [-] Confirm</p>
	0:20	<p>Tank heater ON time set.</p> <p>Tank heater 10:34am, Mon</p> <p>Tank heater: ON time</p> <p>Range: (0:20~3:00)</p> <p>Steps: 10:05</p> <p>0:20</p> <p>Select [-] Confirm</p>
<b>5.8 &gt; Base pan heater</b>		
<p>To select whether or not optional base pan heater is connected.</p> <p>* Type A - The base pan heater activates only during deice operation.</p> <p>* Type B - The base pan heater activates when outdoor ambient temperature is 5 °C or lower.</p>	No	<p>Yes</p> <p>No</p>
	A	<p>Set base pan heater type*.</p> <p>Base pan heater type: 10:34am, Mon</p> <p>A</p> <p>B</p> <p>Select [-] Confirm</p>
<b>5.9 &gt; Alternative outdoor sensor</b>		
To select an alternative outdoor sensor.	No	<p>Yes</p> <p>No</p>
<b>5.10 &gt; Bivalent connection</b>		
<p>To select a bivalent connection to allow an additional heat source such as a boiler to heat-up the buffer tank and domestic hot water tank when heatpump capacity is insufficient at low outdoor temperature. The bivalent feature can be set-up either in alternative mode (heatpump and boiler operate alternately), or in parallel mode (both heatpump and boiler operate simultaneously), or in advance parallel mode (heatpump operates and boiler turns on for buffer-tank and/or domestic hot water depending on the control pattern setting options).</p>	No	<p>Yes</p> <p>No</p>
	-5 °C	<p>Set outdoor temperature for turn ON Bivalent connection.</p> <p>Bivalent connection 10:34am, Mon</p> <p>Turn ON: Outdoor Temp</p> <p>Range: (-15°C~35°C)</p> <p>Steps: 1°C</p> <p>-5 °C</p> <p>Select [-] Confirm</p>
	<p><b>Yes &gt; After selecting the outdoor temperature</b></p> <p><b>Control pattern</b></p> <p>Alternative / Parallel / Advanced parallel</p> <p>• Select advanced parallel for bivalent use of the tanks.</p>	<p>Bivalent connection 10:34am, Mon</p> <p>Control pattern</p> <p>Alternative</p> <p>Parallel</p> <p>Advanced parallel</p> <p>Select [-] Confirm</p>



Menu	Default Setting	Setting Options / Display
<b>Control pattern &gt; Advanced parallel</b>		
Heat	Selection of the tank	Bivalent connection 10:34am, Mon Advanced parallel: Heat DHW Select [-] Confirm
• "Heat" implies Buffer Tank and "DHW" implies Domestic Hot Water Tank.		
<b>Control pattern &gt; Advanced parallel &gt; Heat &gt; Yes</b>		
• Buffer Tank is activated only after selecting "Yes".		Bivalent connection 10:34am, Mon Advanced parallel: Heat Yes No Select [-] Confirm
-8 °C	Set the temperature threshold to start the bivalent heat source.	Bivalent connection 10:34am, Mon Heat start: Target temp. Range: (-10°C-0°C) Steps: ±1°C -8 °C Select [-] Confirm
0:30	Delay timer to start the bivalent heat source (in hour and minutes).	Bivalent connection 10:34am, Mon Heat start: Delay time Range: (0:00-1:30) Steps: ±0:05 0:30 Select [-] Confirm
-2 °C	Set the temperature threshold to stop the bivalent heat source.	Bivalent connection 10:34am, Mon Heat stop: Target temp. Range: (-10°C-0°C) Steps: ±1°C -2 °C Select [-] Confirm
0:30	Delay timer to stop the bivalent heat source (in hour and minutes).	Bivalent connection 10:34am, Mon Heat stop: Delay time Range: (0:00-1:30) Steps: ±0:05 0:30 Select [-] Confirm
<b>Control pattern &gt; Advanced parallel &gt; DHW &gt; Yes</b>		
• DHW Tank is activated only after selecting "Yes".		Bivalent connection 10:34am, Mon Advanced parallel: DHW Yes No Select [-] Confirm
0:30	Delay timer to start the bivalent heat source (in hour and minutes).	Bivalent connection 10:34am, Mon DHW: Delay time Range: (0:30-1:30) Steps: ±0:05 0:30 Select [-] Confirm

Menu	Default Setting	Setting Options / Display	
5.11 > External SW	No	Yes No	
5.12 > Solar connection	No	Yes No	
<ul style="list-style-type: none"> <li>The optional PCB connectivity must be selected YES to enable the function.</li> <li>If the optional PCB connectivity is not selected, the function will not appear on the display.</li> </ul>	> Yes		
	Buffer tank	Selection of the tank	Solar connection 10:34am, Mon ΔT Turn ON Range: (6°C~15°C) Steps: ±1°C 10 °C Select Confirm
	> Yes > After selecting the tank		
	10 °C	Set ΔT ON temperature	Solar connection 10:34am, Mon ΔT Turn ON Range: (6°C~15°C) Steps: ±1°C 10 °C Select Confirm
	> Yes > After selecting the tank > ΔT ON temperature		
	5 °C	Set ΔT OFF temperature	Solar connection 10:34am, Mon ΔT Turn OFF Range: (2°C~9°C) Steps: ±1°C 5 °C Select Confirm
	> Yes > After selecting the tank > ΔT ON temperature > ΔT OFF temperature		
5 °C	Set Antifreeze temperature	Solar connection 10:34am, Mon Anti freeze Range: (-20°C~10°C) Steps: ±1°C 5 °C Select Confirm	
> Yes > After selecting the tank > ΔT ON temperature > ΔT OFF temperature > After setting the antifreeze temperature			
80 °C	Set Hi limit	Solar connection 10:34am, Mon Hi limit Range: (70°C~130°C) Steps: ±5°C 80 °C Select Confirm	

Menu	Default Setting	Setting Options / Display
<b>5.13 &gt; External error signal</b>		
	No	Yes ▲ No
<b>5.14 &gt; Demand control</b>		
	No	Yes ▲ No
<b>5.15 &gt; SG ready</b>		
	No	Yes ▲ No
	<b>&gt; Yes</b>	
	120 %	Capacity (1) & (2) of Buffer Tank and DHW Tank (in %) SG ready 10:34am, Mon Capacity [1-1]: DHW Range: (50%-150%) Steps: ±5% 120 % ▲ Select [-] Confirm
<b>5.16 &gt; External compressor SW</b>		
	No	Yes ▲ No
<b>5.17 &gt; Circulation liquid</b>		
To select whether to circulate water or glycol in the system.	Water	Circulation liquid 10:34am, Mon Water ▼ Glycol ▲ Select [-] Confirm
<b>5.18 &gt; Heat-Cool SW</b>		
	No	Yes ▲ No
<b>5.19 &gt; Force Heater</b>		
To select use Auto turn ON force heater mode or Manual force heater mode.	Manual	Force heater 10:34am, Mon Auto ▲ Manual ▲ Select [-] Confirm
<b>6 Installer setup &gt; Operation setup</b>		
To access to the four major functions or modes.	4 main modes  Heat / *1, *2 Cool / Auto / Tank	Operation setup 12:10am, Mon Heat Cool Auto Tank ▲ Select [-] Confirm

\*1 The system is locked to operate without COOL mode. It can be unlocked only by authorised installers or our authorised service partners.  
\*2 Only displayed when COOL mode is unlocked (This means when COOL mode is available).

Menu	Default Setting	Setting Options / Display
<b>Installer setup &gt; Operation setup</b>		
<b>6.1 &gt; Heat</b>		
To set various water & ambient temperatures for heating.	Water temp. for heating ON / Outdoor temp. for heating OFF / ΔT for heating ON / Outdoor temp. for heater ON	Operation setup 10:34am, Mon Heat Water temp. for heating ON Outdoor temp. for heating OFF ΔT for heating ON Select [←] Confirm
	<b>&gt; Water temp. for heating ON</b>	
	Compensation curve Heating ON temperatures in compensation curve or direct input.	Operation setup 10:34am, Mon Heat ON: Water temp. Compensation curve Direct Select [←] Confirm
	<b>&gt; Water temp. for heating ON &gt; Compensation curve</b>	
	X axis: -5 °C, 15 °C Y axis: 55 °C, 35 °C Input the 4 temperature points (2 on horizontal X axis, 2 on vertical Y axis).	Heat ON: Water temp./zone1 55°C 35°C -5°C 15°C Select [←] Confirm
	<ul style="list-style-type: none"> <li>• Temperature range: X axis: -15 °C ~ 15 °C, Y axis: See below</li> <li>• Temperature range for the Y axis input depends on the model:               <ol style="list-style-type: none"> <li>1. WH-SDC model : 20°C ~ 55°C</li> <li>2. WH-SHF model &amp; Back up heater is enabled: 25°C ~ 65°C</li> <li>3. WH-SHF model &amp; Back up heater is disabled: 35°C ~ 65°C</li> <li>4. WH-SXC model : 20°C ~ 60°C</li> </ol> </li> <li>• If 2 zone system is selected, the 4 temperature points must also be input for Zone 2.</li> <li>• "Zone 1" and "Zone 2" will not appear on the display if only 1 zone system.</li> </ul>	
	<b>&gt; Water temp. for heating ON &gt; Direct</b>	
	35 °C Temperature for heating ON	Operation setup 10:34am, Mon Heat ON: Water temp.: Zone2 Range: (20°C~55°C) Steps: ±1°C 35 °C Select [←] Confirm
	<ul style="list-style-type: none"> <li>• Min. ~ Max. range is conditional as follows:               <ol style="list-style-type: none"> <li>1. WH-SDC model : 20°C ~ 55°C</li> <li>2. WH-SHF model &amp; Back up heater is enabled: 25°C ~ 65°C</li> <li>3. WH-SHF model &amp; Back up heater is disabled: 35°C ~ 65°C</li> <li>4. WH-SXC model : 20°C ~ 60°C</li> </ol> </li> </ul>	
	<b>&gt; Outdoor temp. for heating OFF</b>	
	24 °C Temperature for heating OFF	Operation setup 10:34am, Mon Heat OFF: Outdoor temp. Range: (5°C~35°C) Steps: ±1°C 24 °C Select [←] Confirm

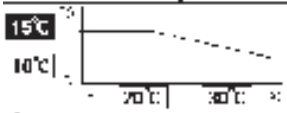
Menu	Default Setting	Setting Options / Display
	> $\Delta T$ for heating ON	
	5 °C	Operation setup 10:34am, Mon Heat ON: $\Delta T$ Range: (1°C~15°C) Steps: $\pm 1^\circ\text{C}$ <b>5</b> °C Select Confirm
	> Outdoor temp. for heater ON	
	0 °C	Operation setup 10:34am, Mon Heater ON: Outdoor temp. Range: (-15°C~20°C) Steps: $\pm 1^\circ\text{C}$ <b>0</b> °C Select Confirm
<b>6.2</b>	<b>&gt; *1, *2 Cool</b>	
To set various water & ambient temperatures for cooling.	Water temperatures for cooling ON and $\Delta T$ for cooling ON.	Operation setup 10:34am, Mon Cool Water temp. for cooling ON $\Delta T$ for cooling ON Select Confirm
	> Water temp. for cooling ON	
	Compensation curve	Operation setup 10:34am, Mon Cool ON: Water temp. Compensation curve Direct Select Confirm
	> Water temp. for cooling ON > Compensation curve	
	X axis: 20 °C, 30 °C Y axis: 15 °C, 10 °C	Cool ON: Water temp. Zone1  Input the 4 temperature points (2 on horizontal X axis, 2 on vertical Y axis) Select Confirm
	<ul style="list-style-type: none"> <li>• If 2 zone system is selected, the 4 temperature points must also be input for Zone 2.</li> <li>• "Zone 1" and "Zone 2" will not appear on the display if only 1 zone system.</li> </ul>	
	> Water temp. for cooling ON > Direct	
	10 °C	Operation setup 10:34am, Mon Cool ON: Water temp.: Zone2 Range: (5°C~20°C) Steps: $\pm 1^\circ\text{C}$ <b>10</b> °C Select Confirm
	> $\Delta T$ for cooling ON	
	5 °C	Operation setup 10:34am, Mon Cool ON: $\Delta T$ Range: (1°C~15°C) Steps: $\pm 1^\circ\text{C}$ <b>5</b> °C Select Confirm

\*1 The system is locked to operate without COOL mode. It can be unlocked only by authorised installers or our authorised service partners.

\*2 Only displayed when COOL mode is unlocked (This means when COOL mode is available).

Menu	Default Setting	Setting Options / Display
<b>6.3</b> > Auto		
Automatic switch from Heat to Cool or Cool to Heat.	Outdoor temperatures for switching from Heat to Cool or Cool to Heat.  Outdoor temp. for (Heat to Cool) / Outdoor temp. for (Cool to Heat)	Operation setup 10:34am, Mon Auto Outdoor temp. for (Heat to Cool) Outdoor temp. for (Cool to Heat) ↓ Select [↔] Confirm
	> Outdoor temp. for (Heat to Cool)	
	15 °C  Set outdoor temperature for switching from Heat to Cool.	Operation setup 10:34am, Mon Auto: Outdoor temp.(Heat to Cool) Range: (11°C-25°C) Steps: ±1°C 15 °C ↕ ↕ Select [↔] Confirm
	> Outdoor temp. for (Cool to Heat)	
	10 °C  Set outdoor temperature for switching from Cool to Heat.	Operation setup 10:34am, Mon Auto: Outdoor temp.(Cool to Heat) Range: (5°C-14°C) Steps: ±1°C 10 °C ↕ ↕ Select [↔] Confirm
<b>6.4</b> > Tank		
Setting functions for the tank.  • Available only if connected to the tank.	Floor operation time (max) / Tank heat up time (max) / Tank re-heat temp. / Sterilization	Operation setup 10:34am, Mon Tank Floor operation time (max) Tank heat up time (max) Tank re-heat temp. ↓ Select [↔] Confirm
	• The display will show 3 functions at a time.	
	> Floor operation time (max)	
	8:00  Maximum time for floor operation (in hours and minutes)	Operation setup 10:34am, Mon Tank: Floor op. time (max) Range: (0:30-10:00) Steps: 30:30 8:00 ↕ ↕ Select [↔] Confirm
	> Tank heat up time (max)	
	1:00  Maximum time for heating the tank (in hours and minutes)	Operation setup 10:34am, Mon Tank: Heat up time (max) Range: (0:05-4:00) Steps: +0:05 1:00 ↕ ↕ Select [↔] Confirm
	> Tank re-heat temp.	
	-8 °C  Set temperature to perform reboil of tank water.	Operation setup 10:34am, Mon Tank: Re-heat temp. Range: (-12°C--2°C) Steps: +1°C -8 °C ↕ ↕ Select [↔] Confirm

Menu	Default Setting	Setting Options / Display														
<b>&gt; Sterilization</b>																
	Sterilization may be set for 1 or more days of the week.  Sun / Mon / Tue / Wed / Thu / Fri / Sat	Operation setup 10:34am, Mon Sterilization: Day <table border="1"> <tr> <td>Sun</td> <td>Mon</td> <td>Tue</td> <td>Wed</td> <td>Thu</td> <td>Fri</td> <td>Sat</td> </tr> <tr> <td>-</td> <td>✓</td> <td>-</td> <td>-</td> <td>-</td> <td>-</td> <td>-</td> </tr> </table> ← Day    ↕ Z/E    [↔] Confirm	Sun	Mon	Tue	Wed	Thu	Fri	Sat	-	✓	-	-	-	-	-
Sun	Mon	Tue	Wed	Thu	Fri	Sat										
-	✓	-	-	-	-	-										
<b>&gt; Sterilization: Time</b>																
	Time of the selected day(s) of the week to sterilize the tank.  0:00 ~ 23:59	Operation setup 10:34am, Mon Sterilization: Time <div style="text-align: center; font-size: 2em;">6 : 00 am</div> ↕ Select    [↔] Confirm														
<b>&gt; Sterilization: Boiling temp.</b>																
65 °C	Set boiling temperatures for sterilize the tank.	Operation setup 10:34am, Mon Sterilization: Boiling temp. Range: (55°C~75°C) Steps: ±1°C <div style="text-align: center; font-size: 1.5em;">65 °C</div> ↕ Select    [↔] Confirm														
<b>&gt; Sterilization: Ope. time (max)</b>																
0:10	Set sterilizing time (in hours and minutes)	Operation setup 10:34am, Mon Sterilization: Ope. time (max) Range: (0:05~1:00) Steps: ±0:05 <div style="text-align: center; font-size: 1.5em;">0:10</div> ↕ Select    [↔] Confirm														
<b>7 Installer setup &gt; Service setup</b>																
<b>7.1 &gt; Pump maximum speed</b>																
To set the maximum speed of the pump.	Setting the flow rate, max. duty and operation ON/OFF of the pump.  Flow rate: XX.X L/min Max. Duty: 0x40 ~ 0xFE, Pump: ON/OFF/Air Purge	Service setup 10:34am, Mon Flow rate    Max. Duty    Operation 0.0 L/min    0xCE    ← Air Purge ← Select														
<b>7.2 &gt; Pump down</b>																
To set the pump down operation.	<b>Pump down operation</b>  ON	Service setup 10:34am, Mon <div style="border: 1px solid black; padding: 5px; text-align: center;">             Pump down operation              In progress!              [↔] Confirm           </div> ← Select														

Menu	Default Setting	Setting Options / Display
<b>Installer setup &gt; Service setup</b>		
<b>7.3 &gt; Dry concrete</b>		
<p>To dry the concrete (floor, walls, etc.) during construction.</p> <p>Do not use this menu for any other purposes and in period other than during construction.</p>	<p>Edit to set the temperature of dry concrete.</p> <p>ON / Edit</p>	<p>Service setup 10:34am, Mon</p> <p>Dry concrete</p> <p>ON</p> <p>Edit</p> <p>↓ Select [←] Confirm</p>
	<b>&gt; Edit</b>	
	<p>Stages: 1</p> <p>Temperature: 25 °C</p>	<p>Heating temperature for drying the concrete.</p> <p>Select the desired stages: 1 ~ 10, range: 1 ~ 99</p> <p>Service setup 10:34am, Mon</p> <p>Dry concrete: 1/10</p> <p>Range: (25°C~55°C)</p> <p>Steps: ±1°C</p> <p>25 °C</p> <p>↑ Select [←] Confirm</p>
	<b>&gt; ON</b>	
<p>Confirm the setting temperatures of dry concrete for each stage.</p>	<p>Service setup 10:34am, Mon</p> <p>Dry concrete: Status</p> <p>Stage : 1/10</p> <p>Water set temp. : 25°C</p> <p>Actual water temp. : 25°C/25°C</p> <p>[⏻] OFF</p>	
<b>7.4 &gt; Service contact</b>		
<p>To set up to 2 contact names and numbers for the User.</p>	<p>Service engineer's name and contact number.</p> <p>Contact 1 / Contact 2</p>	<p>Service setup 10:34am, Mon</p> <p>Service contact:</p> <p>Contact 1</p> <p>Contact 2</p> <p>↓ Select [←] Confirm</p>
	<b>&gt; Contact 1 / Contact 2</b>	
	<p>Contact name or number.</p> <p>Name / phone icon</p>	<p>Service contact 10:34am, Mon</p> <p>Contact 1</p> <p>Name : Bryan Atkins</p> <p>☎ : 08812345678</p> <p>↓ Select [←] Edit</p>
	<p>Input name and number.</p> <p>Contact name: alphabet a ~ z.</p> <p>Contact number: 1 ~ 9</p>	<p>Contact-1</p> <p>ABC/abc 0 9/0 the</p> <p>ABCDEFGHIJKL MNOPQR Space</p> <p>STUVWXYZ abcdefghl BS</p> <p>jklmnopqrstuvwxye Conf</p> <p>↓ Select [←] Enter</p> <p>Number:</p> <p>1 2 3 (</p> <p>4 5 6 )</p> <p>7 8 9 BS</p> <p>* 0 # _ Conf</p> <p>↓ Select [←] Enter</p>



### 4.1.6 Main Components

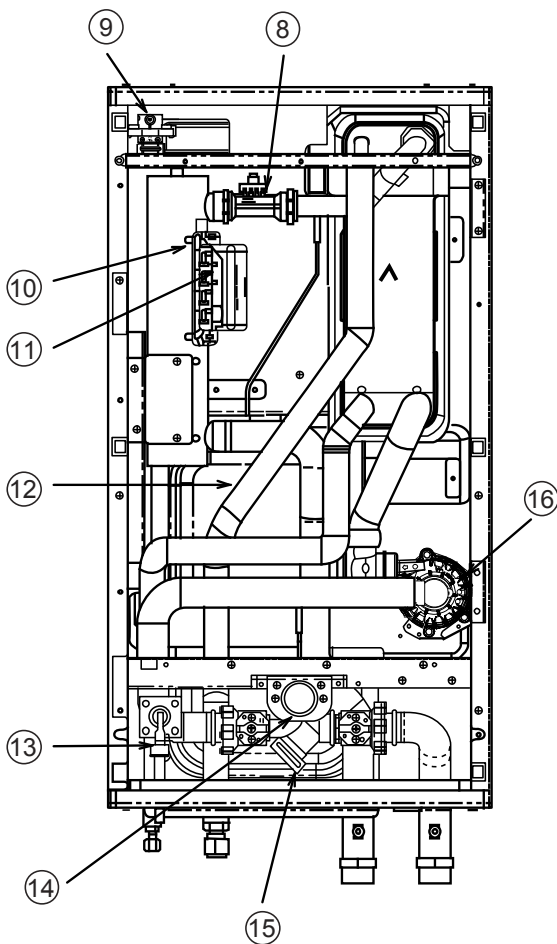
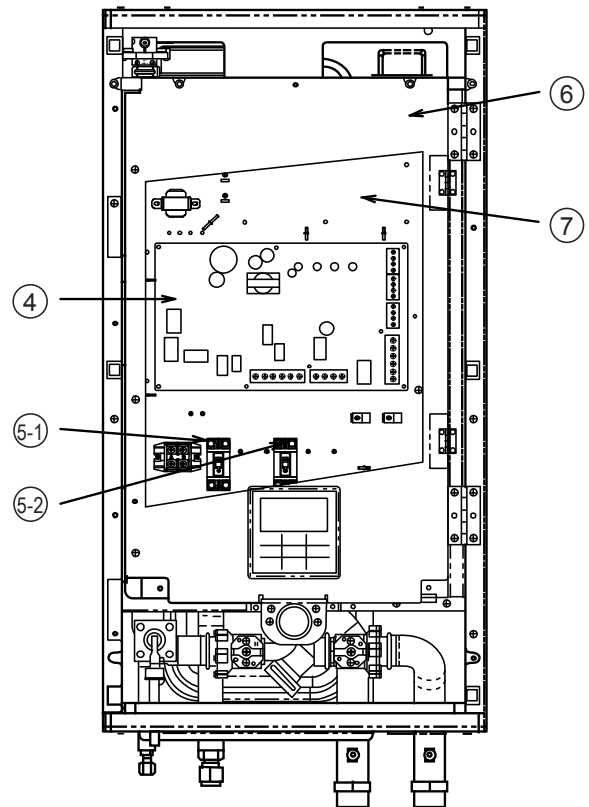
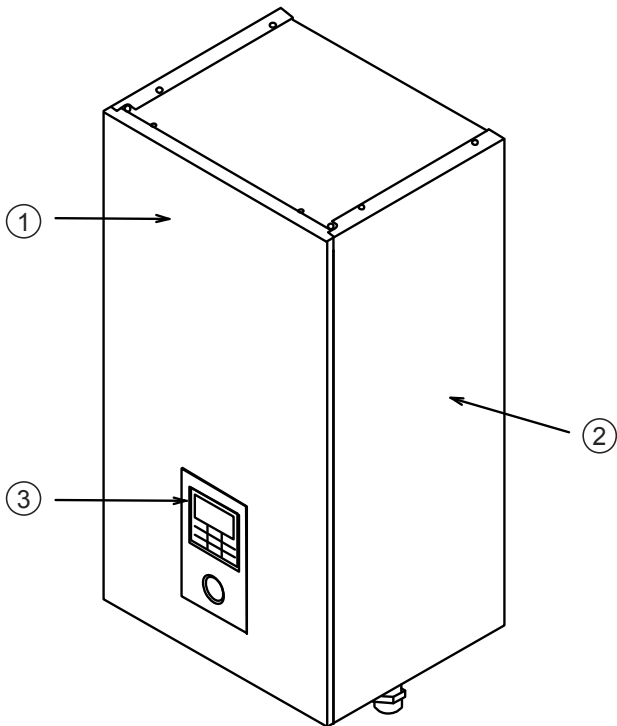

- ① Cabinet front plate
- ② Cabinet front plate (2 pieces)
- ③ Remote controller
- ④ PCB
- ⑤-1 Single Phase RCCB/ELCB (Main Power)
- ⑤-2 Single Phase RCCB/ELCB (Backup Heater)
- ⑥ Control board cover
- ⑦ Control board
- ⑧ Flow sensor
- ⑨ Air purge valve
- ⑩ Backup heater
- ⑪ Overload protector (2 pieces for SXC09\*3E5 or 3 pieces for SXC12\*6E5)
- ⑫ Expansion vessel
- ⑬ Pressure relief valve
- ⑭ Water pressure gauge
- ⑮ Water filter
- ⑯ Water pump

## 4.2 Outdoor Unit

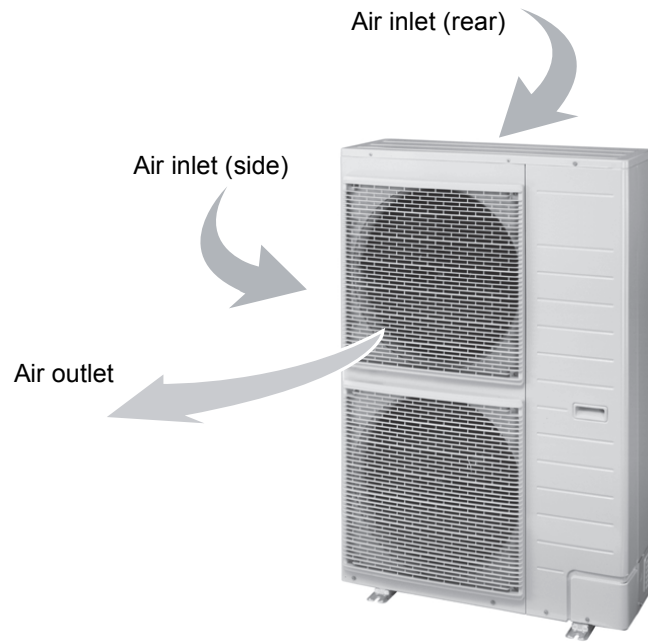

# 5. Dimensions

## 5.1 Indoor Unit

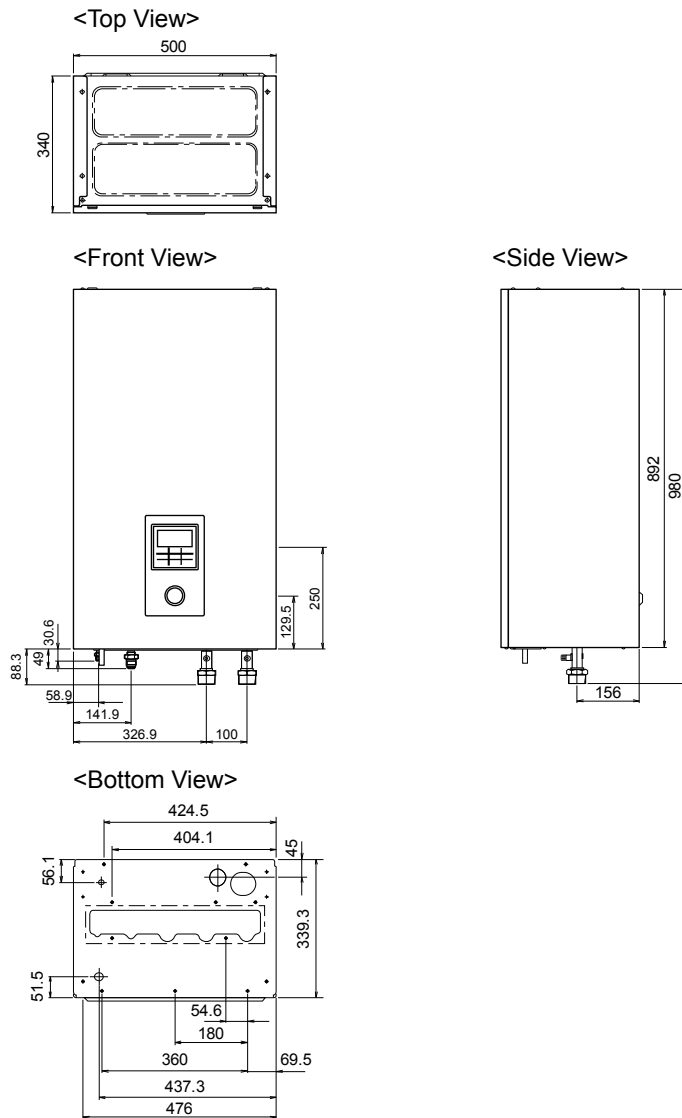

Relative position between the indoor unit and the installation plate <Front View>

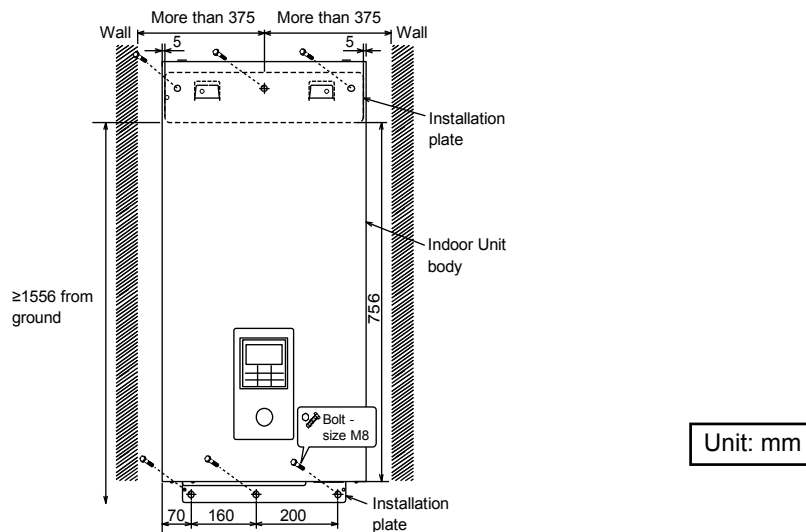

## 5.2 Outdoor Unit

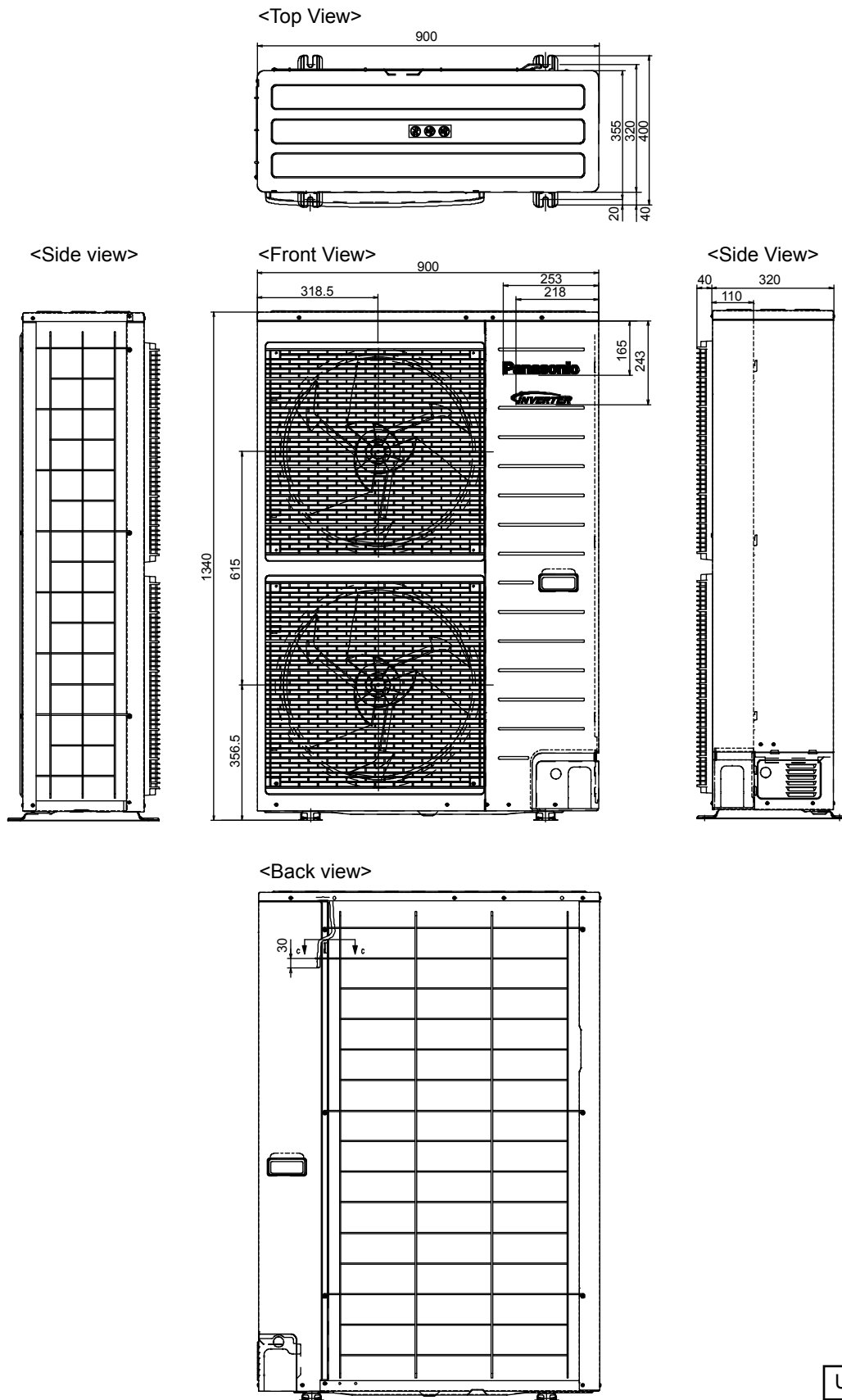

# 6. Refrigeration and Water Cycle Diagram

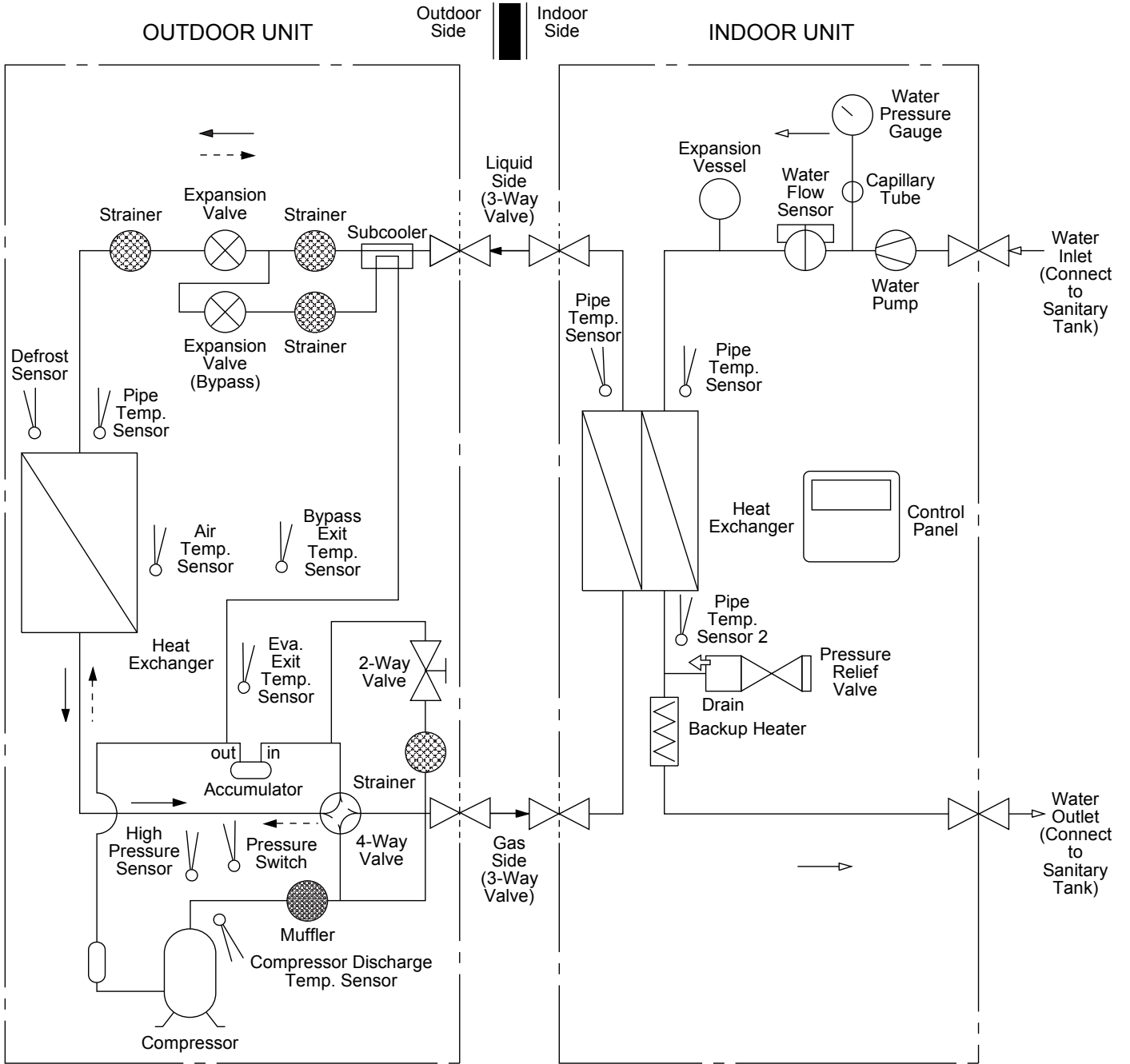

Model	Piping size		Rated Length (m)		Max Elevation (m)	Min. Piping Length (m)	Max. Piping Length (m)	Additional Refrigerant (g/m)
	Gas	Liquid	For Heat Pump Indoor Unit	For Hydromodule + Tank				
UX09*E5*, UX12*E5*, UD12*E5*, UD16*E5*, UX09*E8*, UX12*E8*, UX16*E8*, UD09*E8*, UD12*E8*, UD16*E8*	Ø15.88 mm (5/8")	Ø9.52 mm (3/8")	7	5	20	3	30	50

Example:

If piping length is 30m, the quantity of additional refrigerant should be 1000g. [(30-10)m x 50 g/m = 1000g]

GWP (R410A) = 2088

## 6.1 Standard System (Optional PCB not connected)

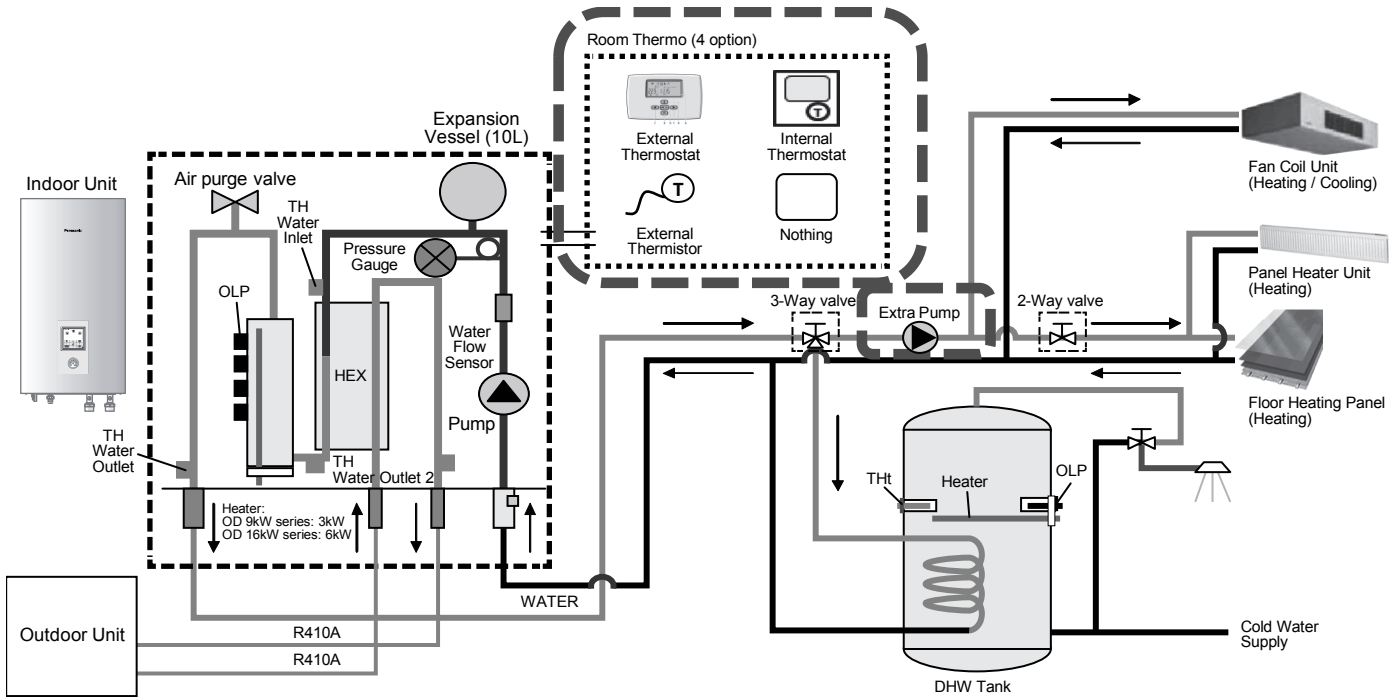

## 6.2 Advance System (Optional PCB connected)

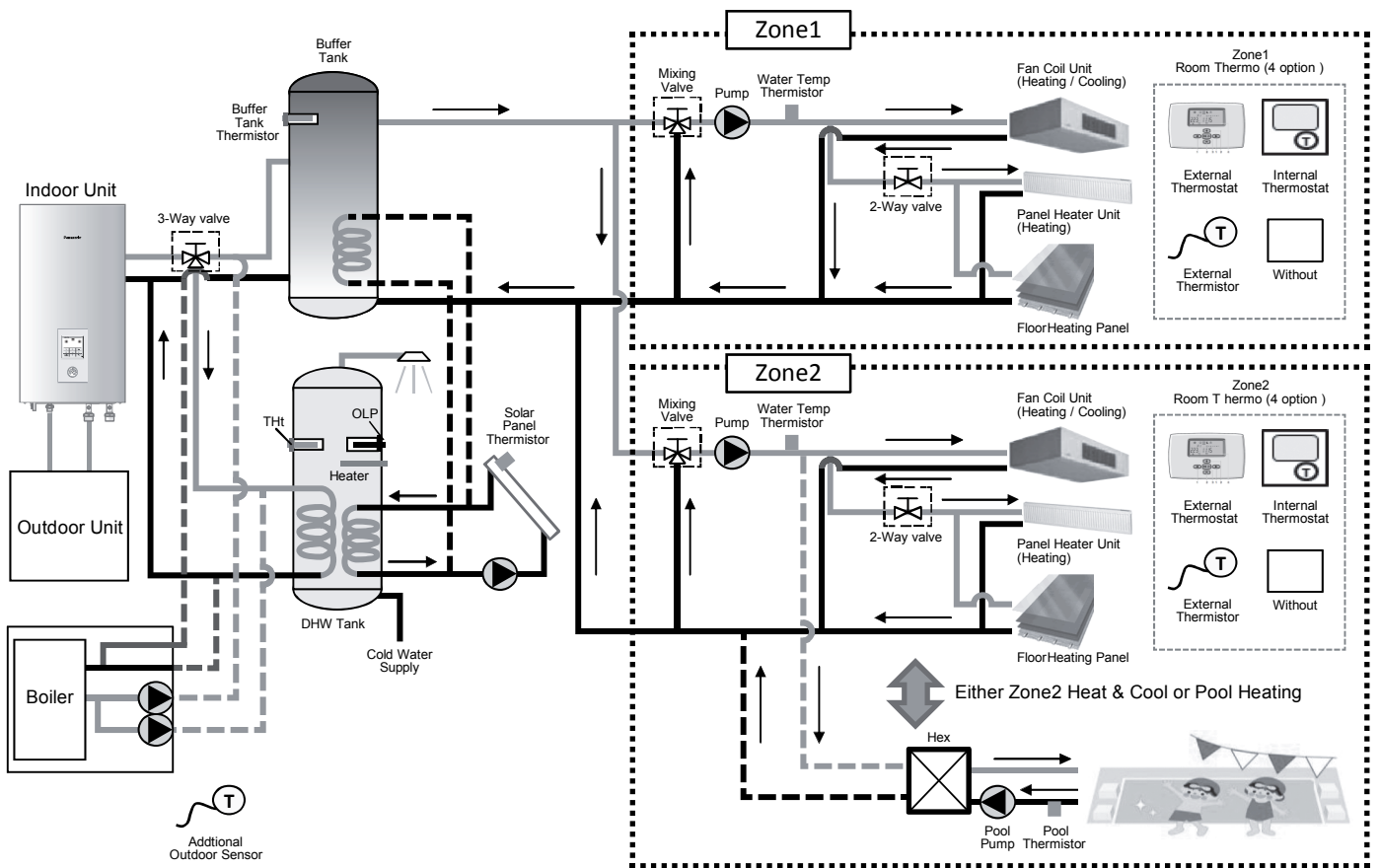

# 7. Block Diagram

## 7.1 WH-SXC09H3E5 WH-UX09HE5

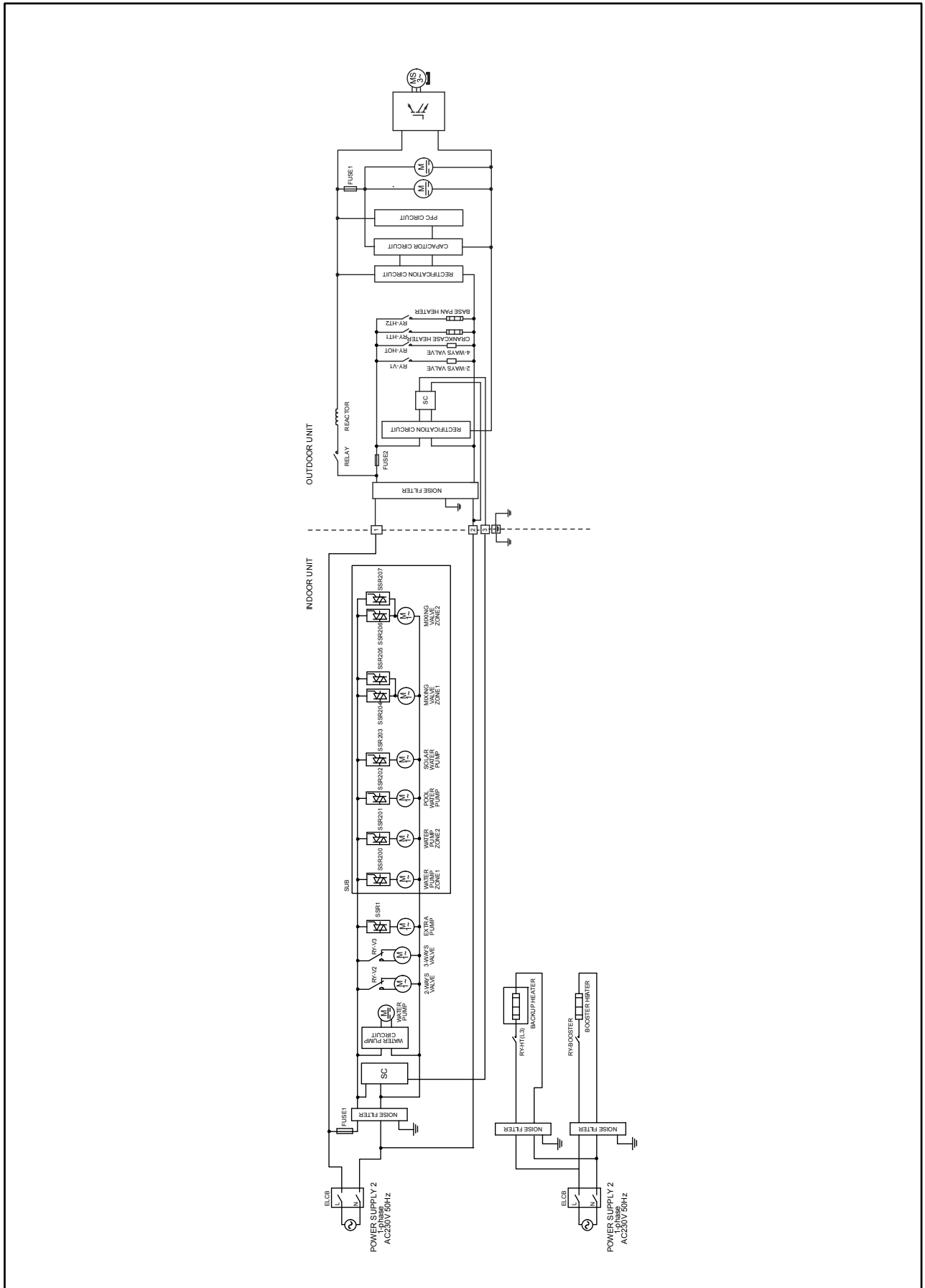

## 7.2 WH-SXC12H6E5 WH-UX12HE5

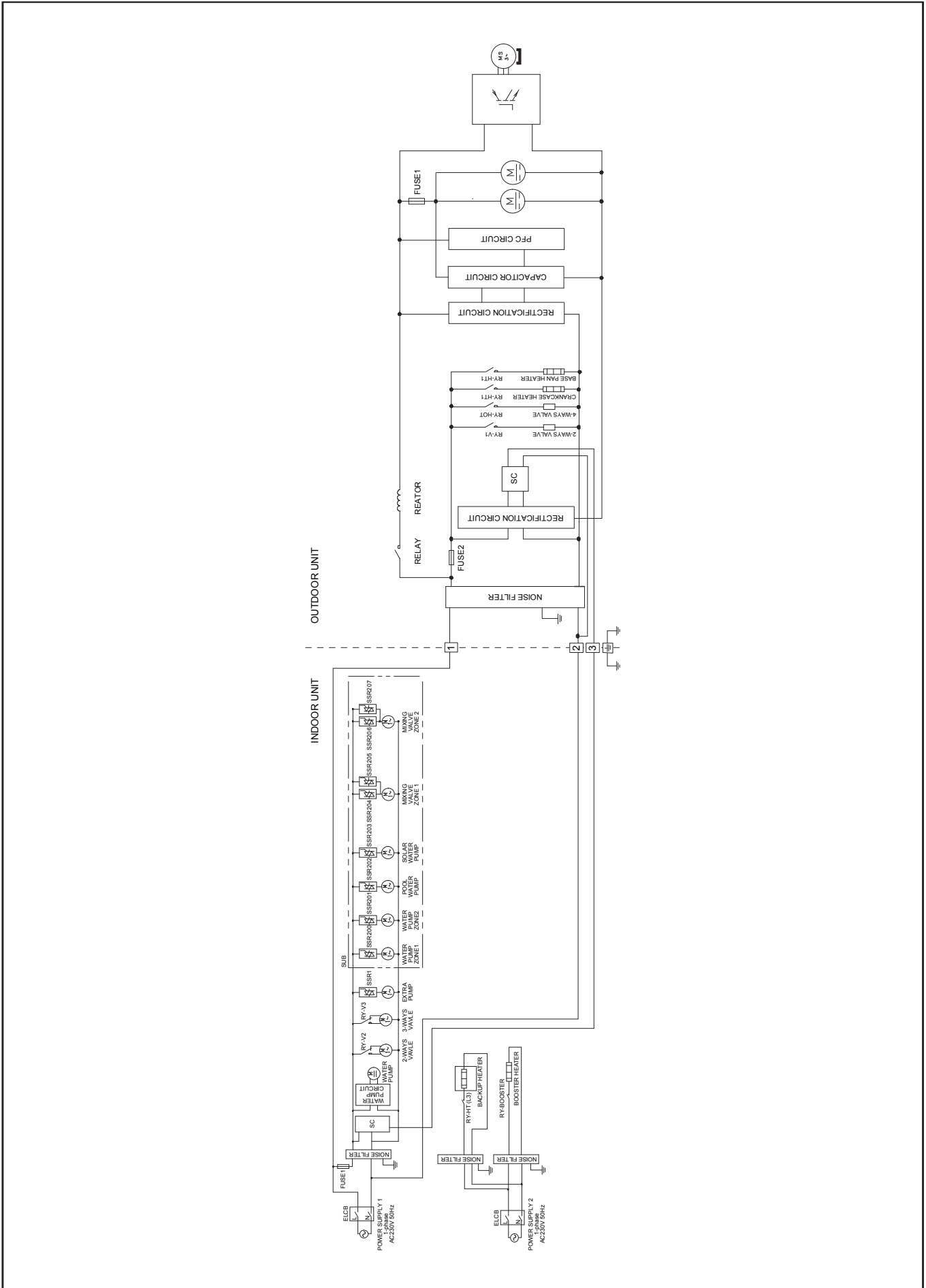



# 8. Wiring Connection Diagram

## 8.1 Indoor Unit

### 8.1.1 WH-SXC09H3E5

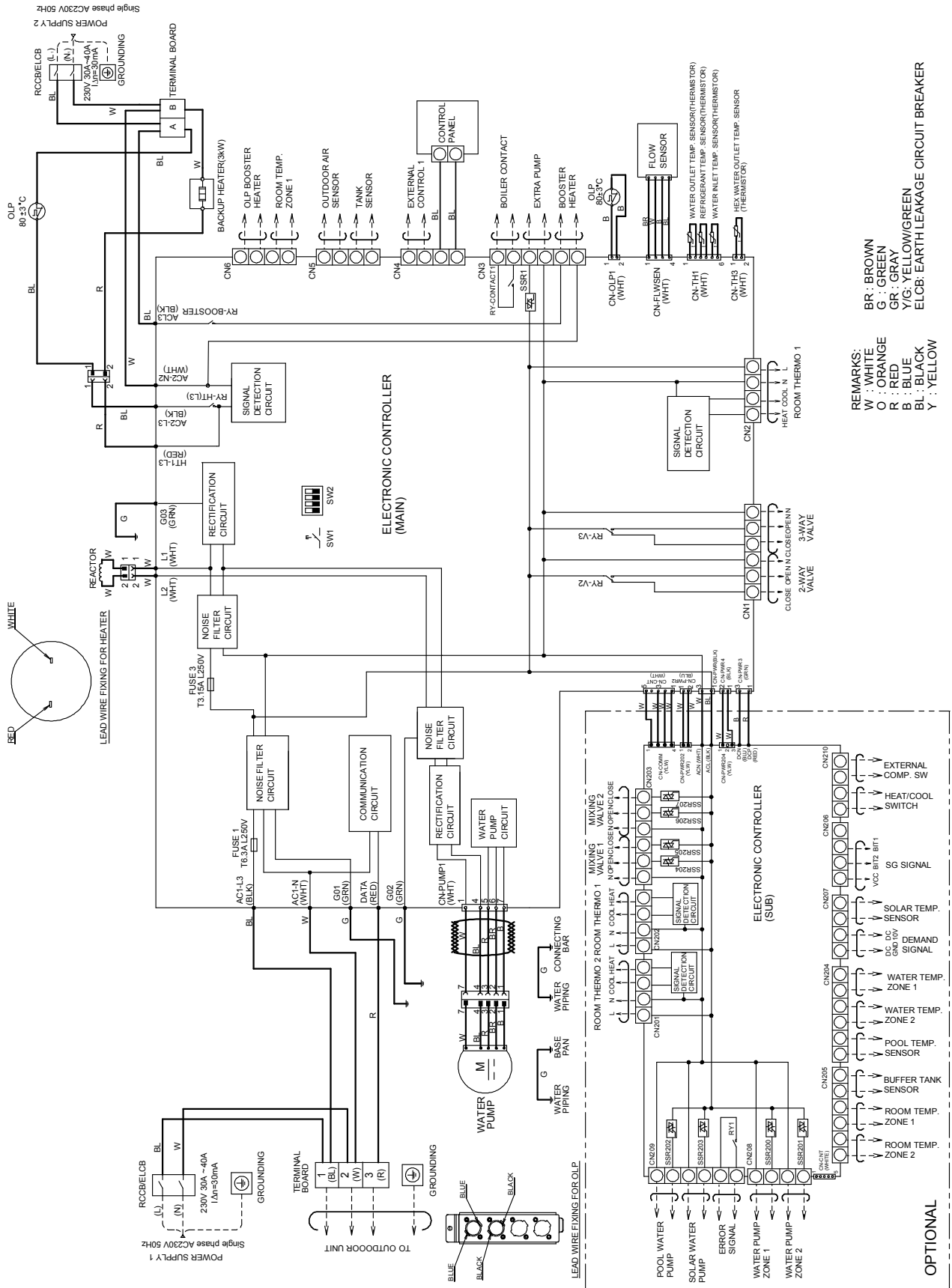

# 8.1.2 WH-SXC12H6E5

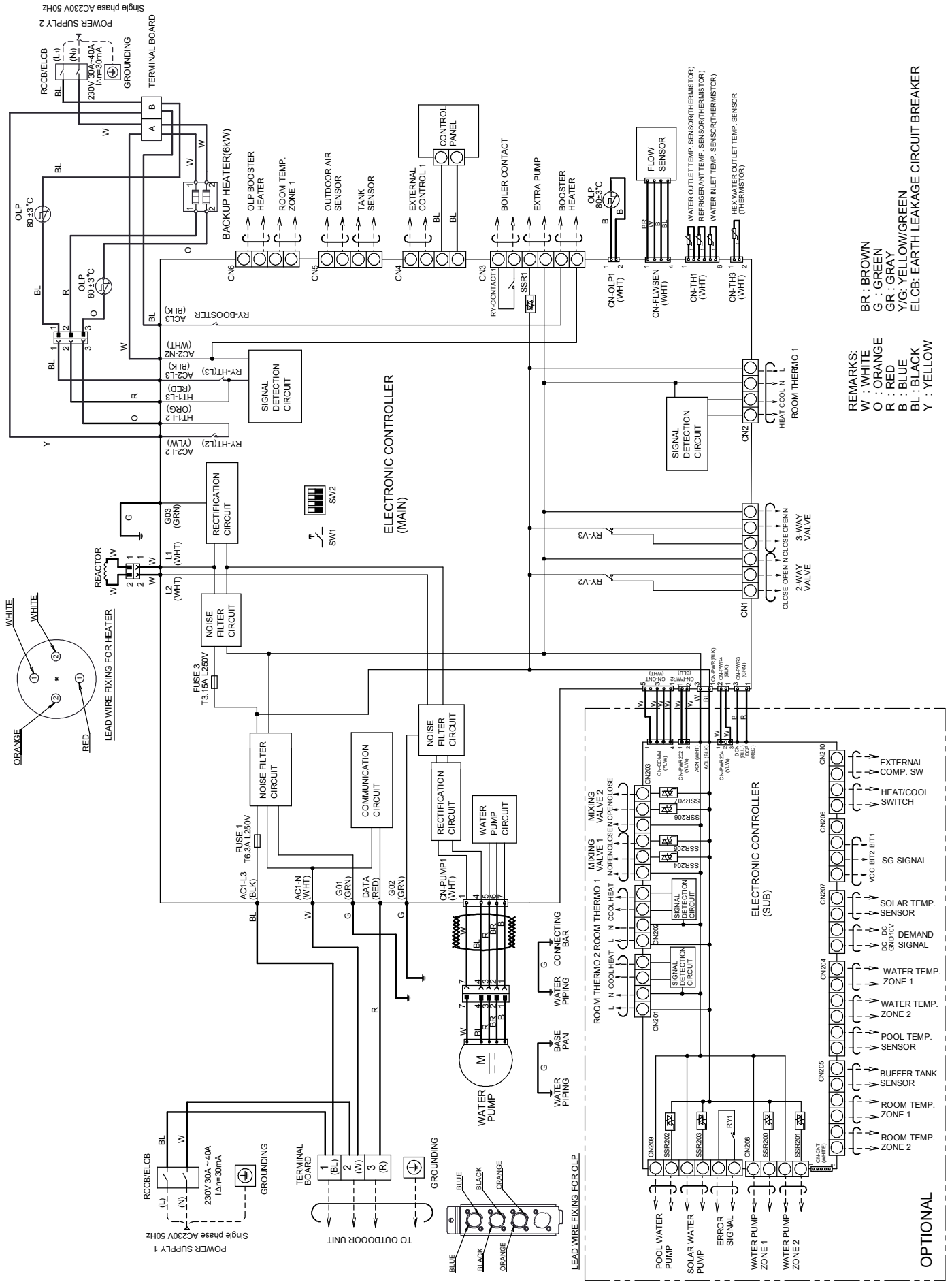

# 8.2 Outdoor Unit

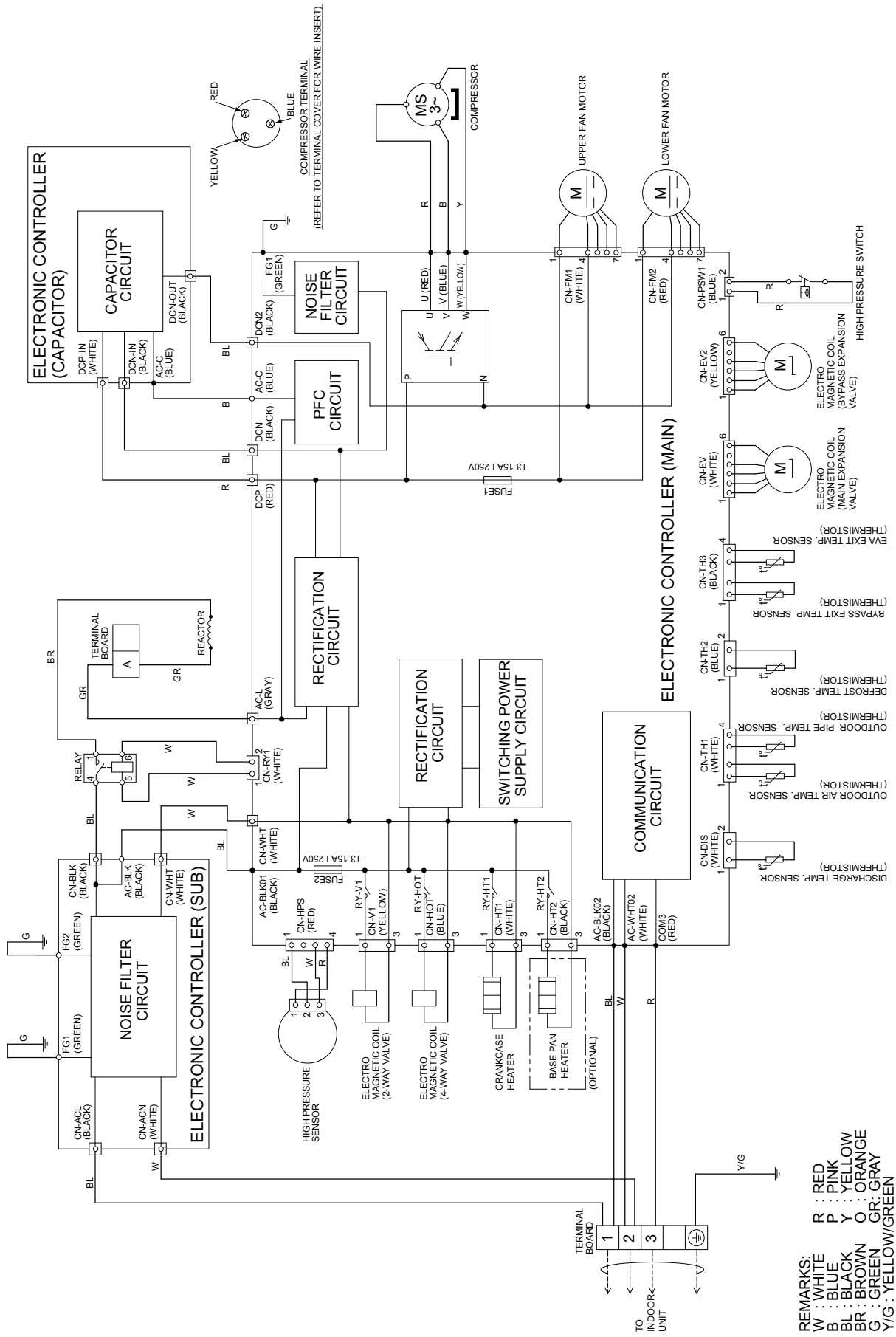

REMARKS:  
 R : RED  
 W : WHITE  
 B : BLUE  
 BL : BLACK  
 BR : BROWN  
 G : GREEN  
 Y/G : YELLOW/GREEN  
 P : PINK  
 Y : YELLOW  
 O : ORANGE  
 GR : GRAY

# 9. Electronic Circuit Diagram

## 9.1 Indoor Unit

### 9.1.1 WH-SXC09H3E5

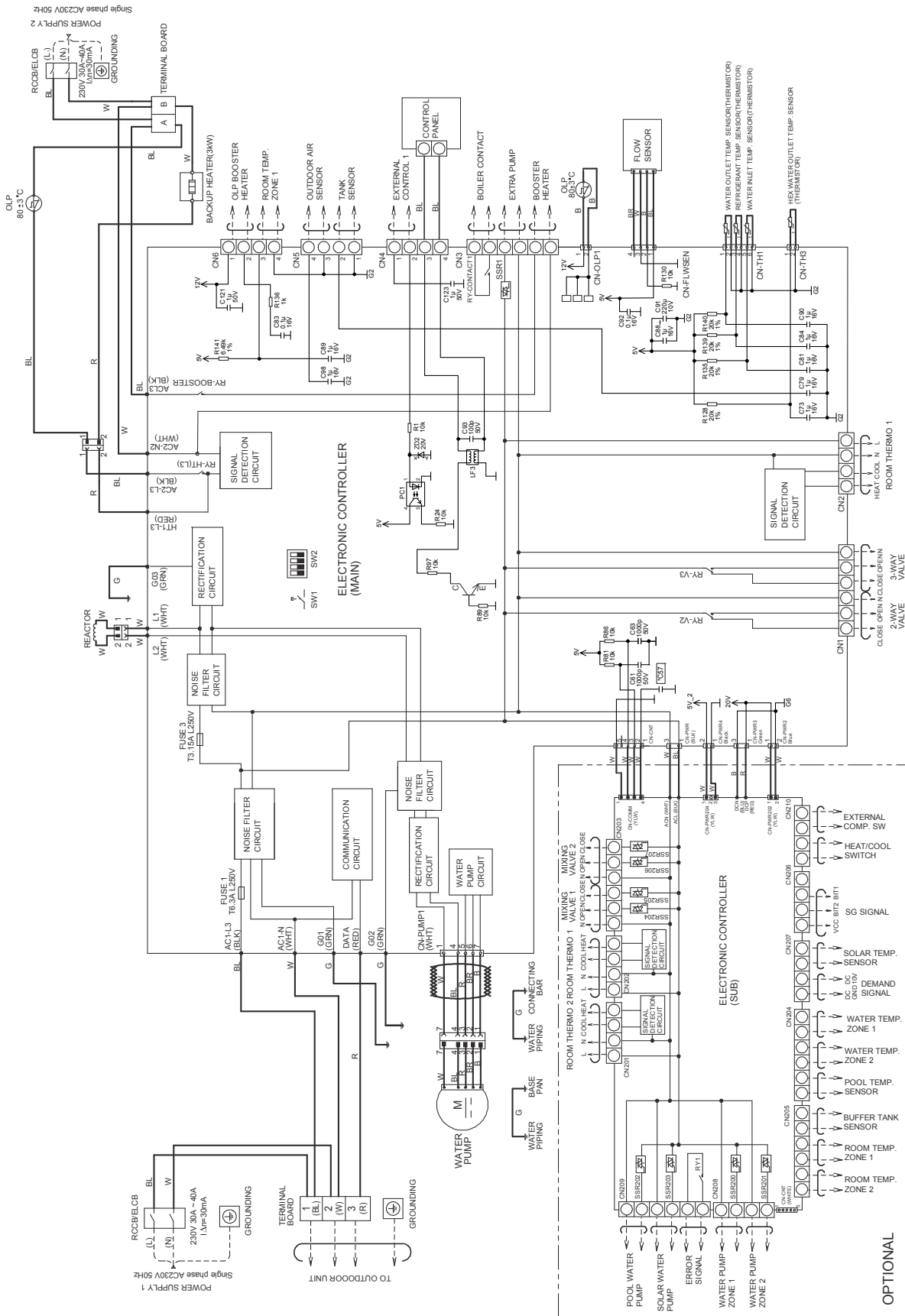

# 9.1.2 WH-SXC12H6E8

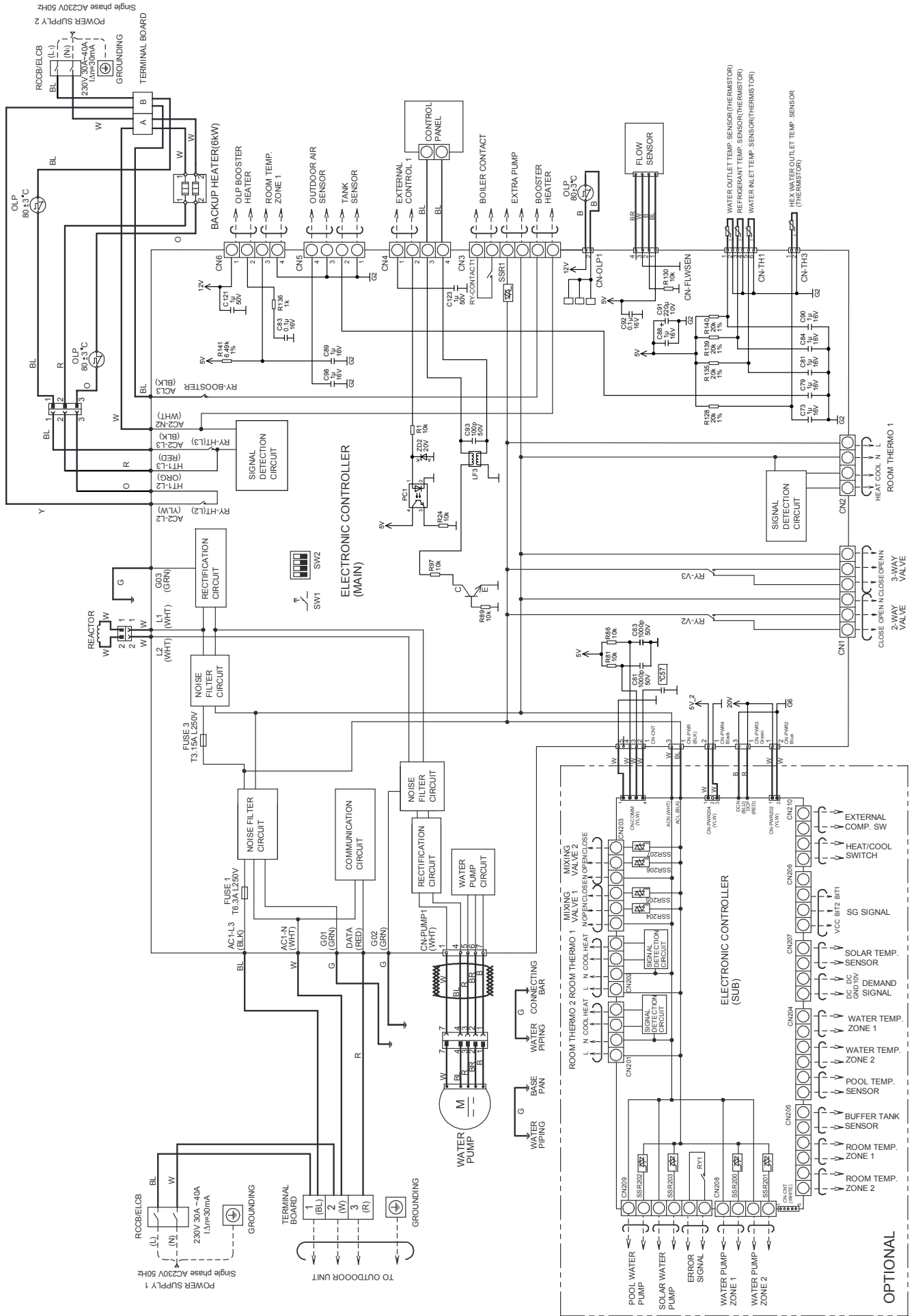



# 10. Printed Circuit Board

## 10.1 Indoor Unit

### 10.1.1 Main Printed Circuit Board

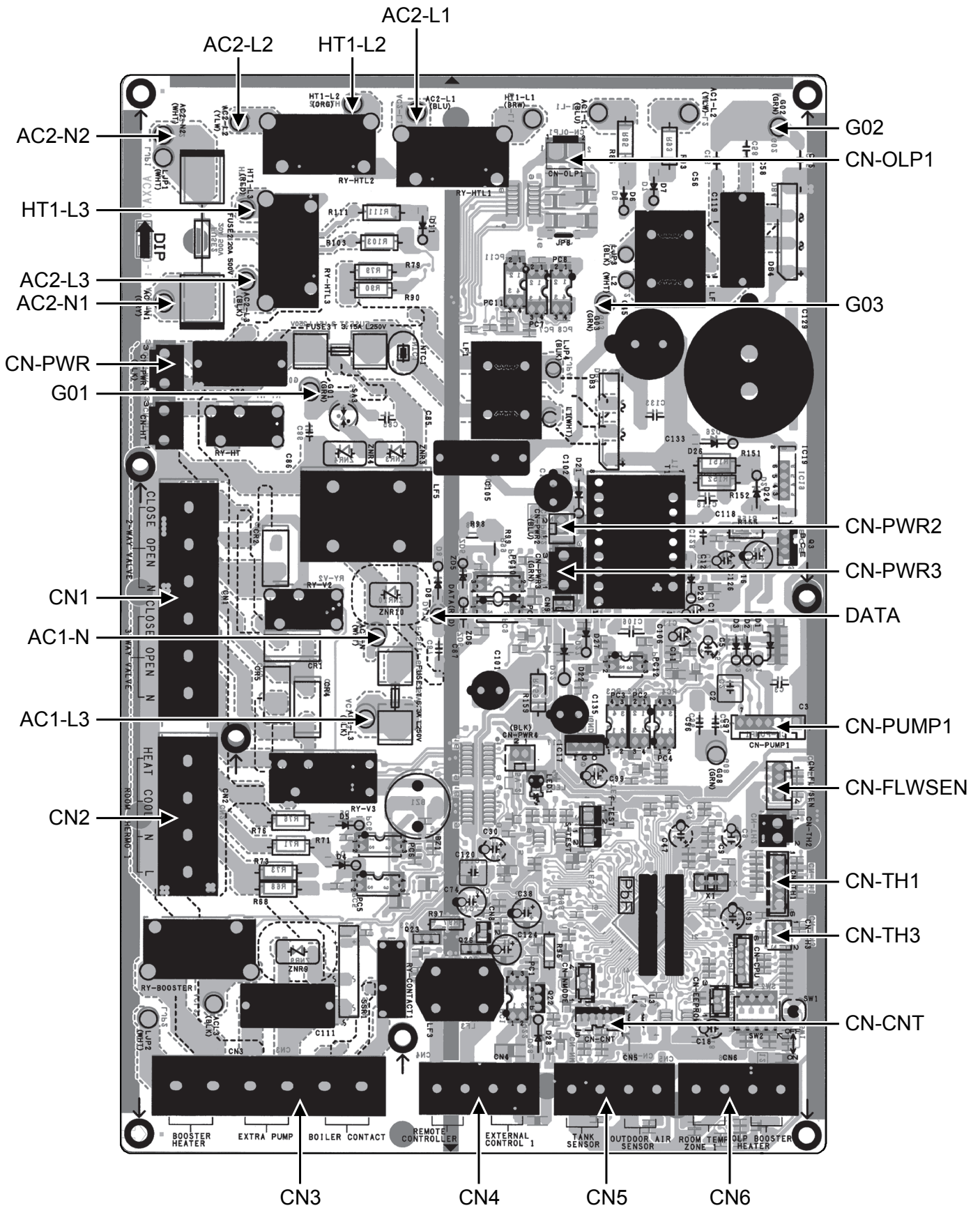

## 10.1.2 Sub Printed Circuit Board (Optional)

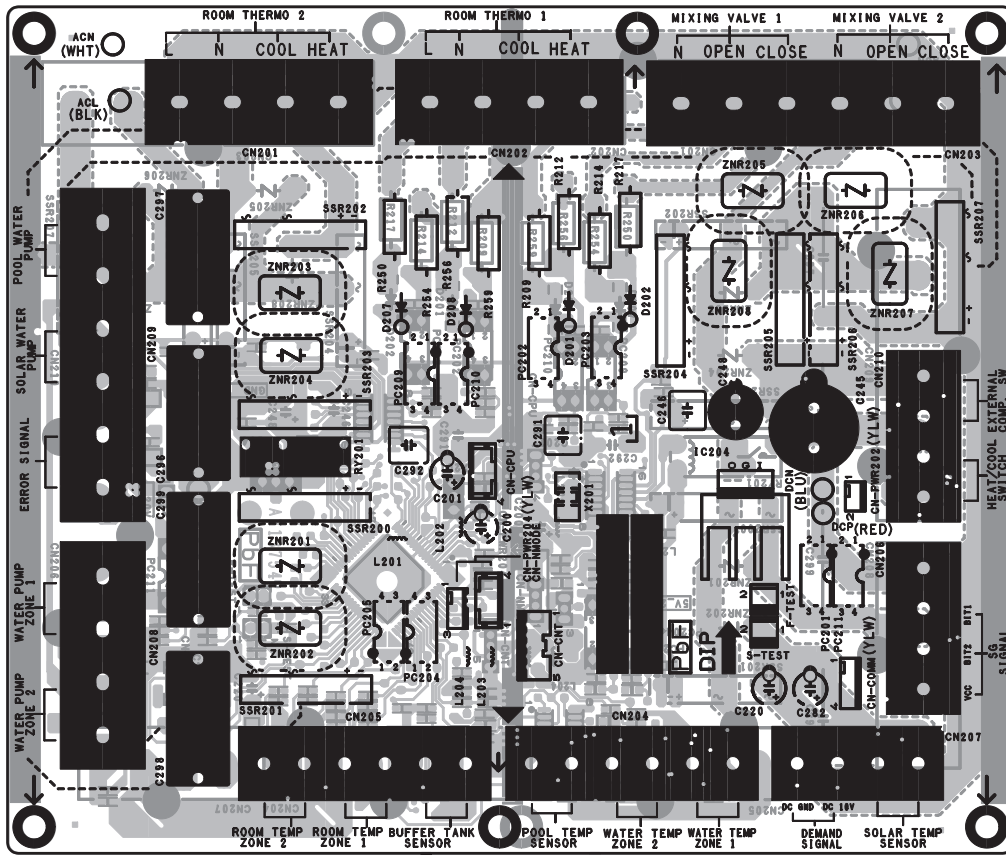



## 10.2 Outdoor Unit

### 10.2.1 Main Printed Circuit Board

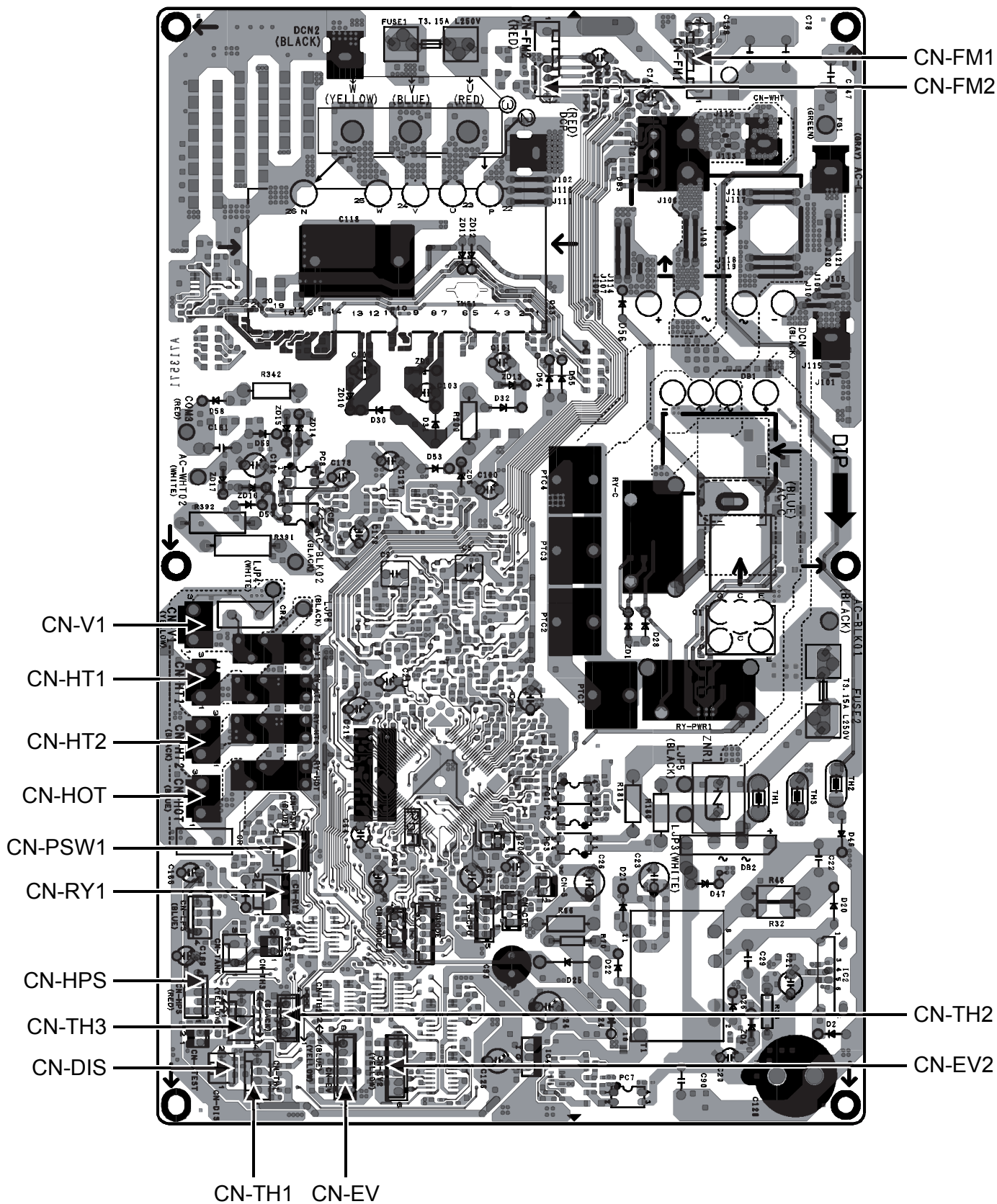

### 10.2.2 Noise Filter Printed Circuit Board

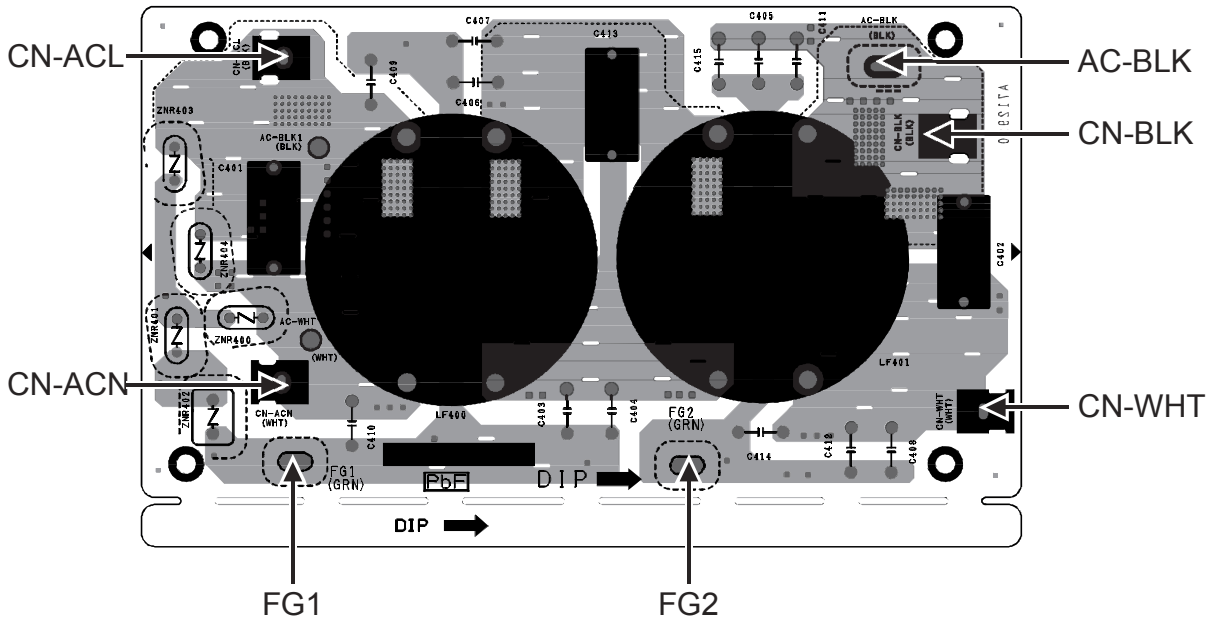

### 10.2.3 Capacitor Printed Board

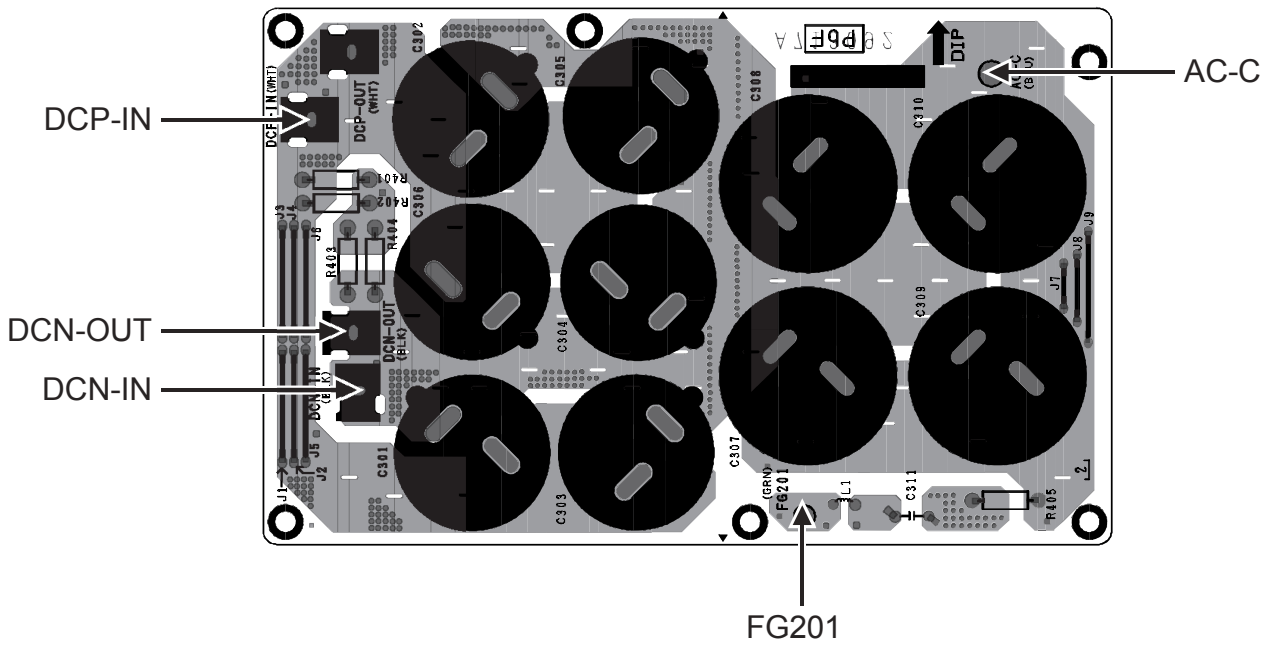

# 11. Installation Instruction

## 11.1 Indoor Unit

### 11.1.1 Select the Best Location

- There should not be any heat source or steam near the unit.
- A place where air circulation in the room is good.
- A place where drainage can be easily done.
- A place where noise prevention is taken into consideration.
- Do not install the unit near the door way.
- Ensure the spaces indicated by arrows from the wall, ceiling, fence or other obstacles.
- Recommended installation height for indoor unit shall be at least 800 mm.
- Must install on a vertical wall.
- When install electrical equipment at wooden building of metal lath or wire lath, according to electrical facility technical standard, no electrical contact between equipment and building is allowed. Insulator must be installed in between.
- Do not install the unit at outdoor. This is designed for indoor installation only.

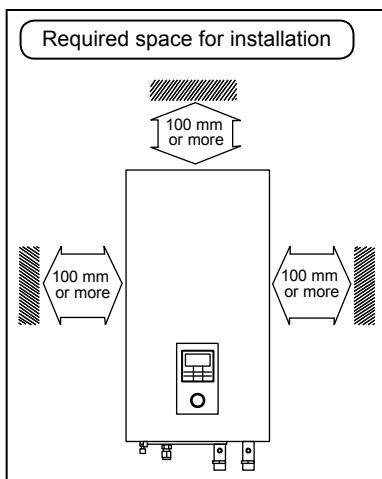

### 11.1.2 How To Fix Installation Plate

The mounting wall is strong and solid enough to prevent it from vibration.

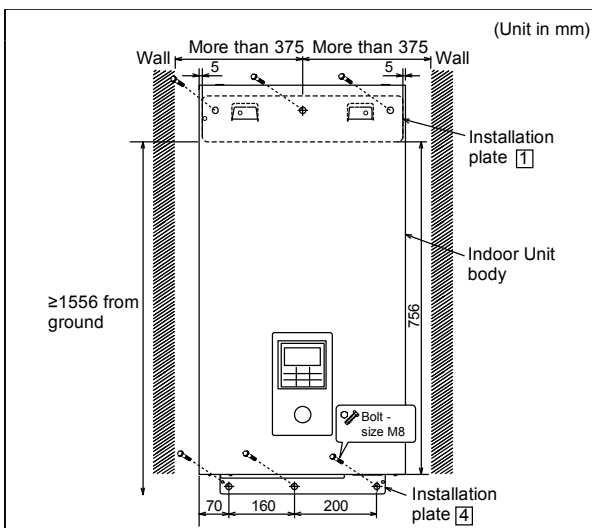

The centre of installation plate should be at more than 375 mm at right and left of the wall.

The distance from installation plate edge to ground should more than 1556 mm.

- Always mount the installation plate horizontally plate by aligning the marking thread and using a level gauge.
- Mount the installation plate on the wall with 6 sets of plug, bolt and washer (all non-supply) with size M8.

### 11.1.3 To Drill A Hole In The Wall And Install A Sleeve Of Piping

1. Insert the piping sleeve to the hole.
2. Fix the bushing to the sleeve.
3. Cut the sleeve until it extrudes about 15 mm from the wall.

**CAUTION**

When the wall is hollow, please be sure to use the sleeve for tube assembly to prevent dangers caused by mice biting the connection cable.

4. Finish by sealing the sleeve with putty or caulking compound at the final stage.

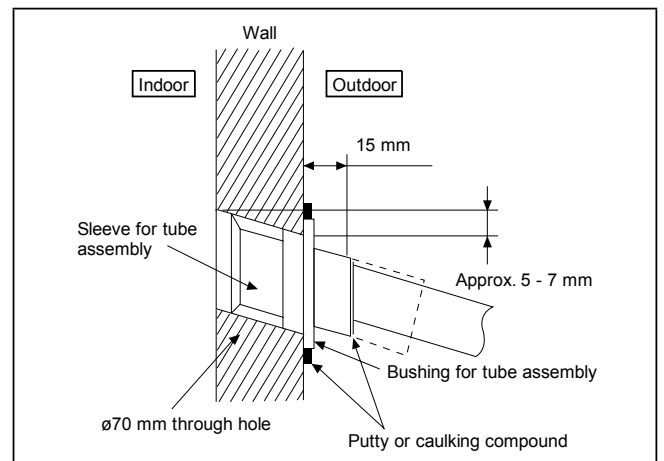

### 11.1.4 Indoor Unit Installation

#### 11.1.4.1 Access to Internal Components

**WARNING**

This section is for authorized and licensed electrician/water system installer only. Work behind the front plate secured by screws must only be carried out under supervision of qualified contractor, installation engineer or service person.

Please follow the steps below for take out front plate. Before removing the front plate of indoor unit, always switch off all power supply (i.e. indoor unit power supply, heater power supply and Tank Unit power supply).

1. Remove the 2 mounting screws which located at bottom of the front plate.

2. Gently pull the lower section of the front plate towards you to remove the front plate from left and right hooks.
3. Hold the left edge and right edge of front plate to lift up front plate from hooks.

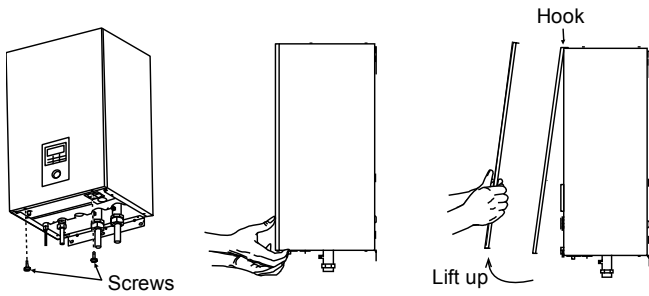

#### 11.1.4.2 Install the indoor unit

1. Engage the slots on the indoor unit to the hooks of installation plate ①. Ensure the hooks are properly seated on the installation plate by moving it left and right.
2. Fix the screws ⑤ to the holes on the hooks of installation plate ④, as illustrated below.

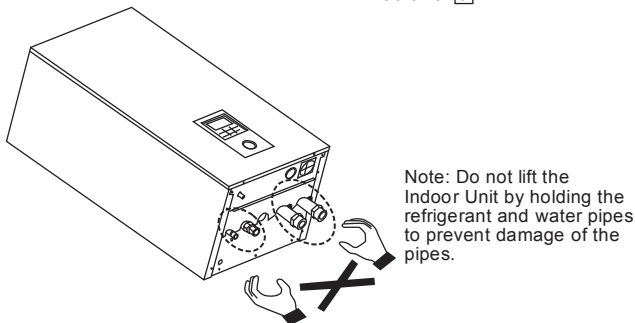
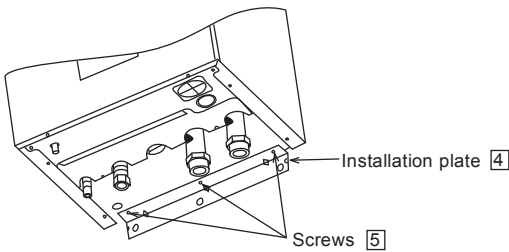
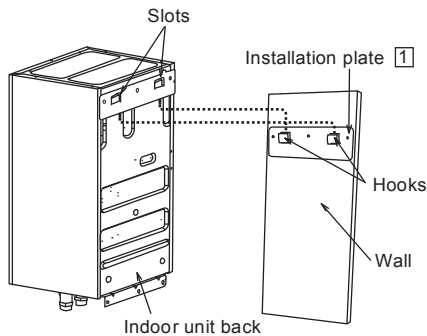

#### 11.1.4.3 Water Piping Installation

- The minimum requirement of water in the system is 50 litres. If this value could not be achieved, please install additional buffer tank (field supply).
- Water inlet and water outlet in indoor unit are used for connection to water circuit. Please request a licensed technician to install this water circuit.

- This water circuit must comply with all relevant European and national regulations, i.e. IEC/EN 61770.
- Be careful not to deform the piping to excessive force when doing piping connection job.
- Use Rp 1 ¼" nut for both water inlet and outlet connection and clean all pipings with tap water before connecting to the indoor unit.
- Cover the pipe end to prevent dirt and dust when inserting it through a wall.
- Choose proper sealer which can withstand the pressures and temperatures of the system.
- If an existing tank is to be connected to this indoor unit, ensure the pipes are clean before water pipe installation is carried out.
- Be sure to use two spanners to tighten the connection. Tighten the nuts with torque wrench: 117.6N•m.

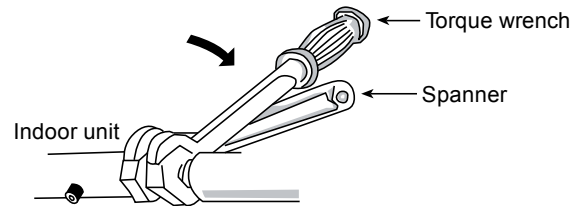

- If non-brass metallic piping is used for installation, make sure to insulate the pipes to prevent galvanic corrosion.
- Make sure to insulate the water circuit pipes to prevent reduction of heating capacity.
- After installation, check the water leakage condition in connection area during test run.

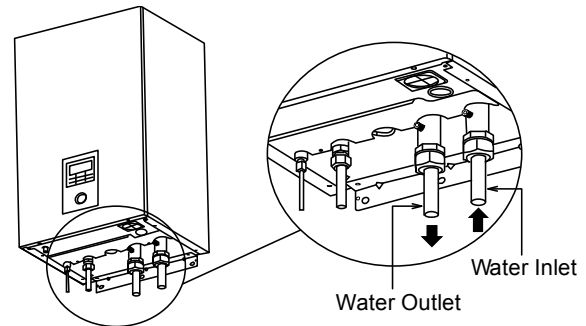

**CAUTION**  
Do not over tighten, over tightening cause water leakage.

#### 11.1.4.4 Refrigerant Pipe Installation

- 1 Please make flare after inserting flare nut (located at joint portion of tube assembly) onto the copper pipe. (In case of using long piping)
- 2 Do not use pipe wrench to open refrigerant piping. Flare nut may be broken and cause leakage. Use proper spanner or ring wrench.
- 3 Connect the piping:
  - Align the center of piping and sufficiently tighten the flare nut with fingers.
  - Be sure to use two spanners to tighten the connection.  
Further tighten the flare nut with torque wrench in specified torque as stated in the table.

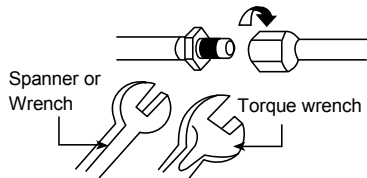

Piping size (Torque)	
Gas	Liquid
ø15.88 mm (5/8") [65 N•m]	Ø9.52 mm (3/8") [42 N•m]

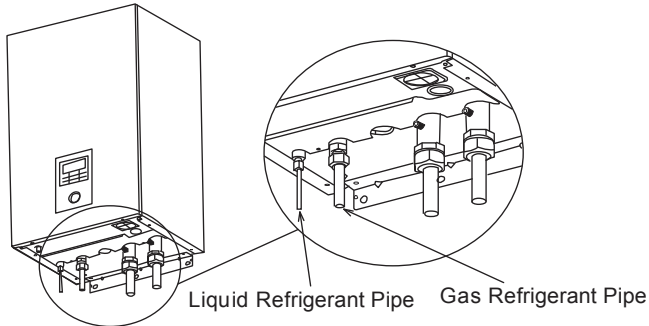

<b>⚠ CAUTION</b>
Do not over tighten, over tightening cause water leakage.
<b>⚠ CAUTION</b>
Please take extra precaution when open the control board cover ⑥ and control board ⑦ for indoor unit installation and servicing. Failure to do so may cause injury.

### CUTTING AND FLARING THE PIPING

1. Please cut using pipe cutter and then remove the burrs.
2. Remove the burrs by using reamer. If burrs is not removed, gas leakage may be caused. Turn the piping end down to avoid the metal powder entering the pipe.
3. Please make flare after inserting the flare nut onto the copper pipes.

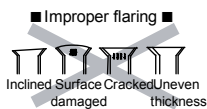
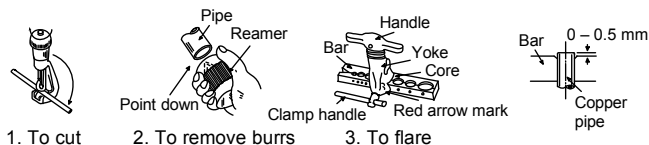

When properly flared, the internal surface of the flare will evenly shine and be of even thickness. Since the flare part comes into contact with the connections, carefully check the flare finish.

### 11.1.4.5 Drain Elbow and Hose Installation

- Fix the drain elbow ② and packing ③ to the bottom of indoor unit, as shown in below illustration.
- Use inner diameter 17 mm drain hose in the market.
- This hose must be installed in a continuously downward direction and in a frost-free environment.
- Guides this hose's outlet to outdoor only.
- Do not insert this hose into sewage or drain pipe that may generate ammonia gas, sulfuric gas, etc.

- If necessary, use hose clamp to further tighten the hose at drain hose connector to prevent leakage.
- Water will drip from this hose, therefore the outlet of this hose must be installed in an area where the outlet cannot become blocked.

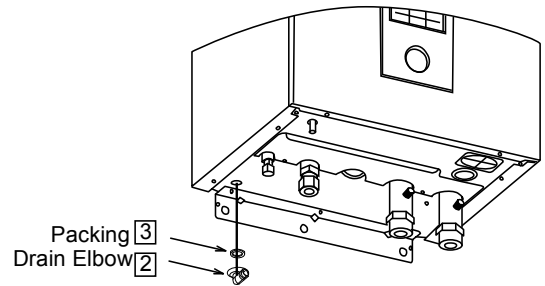

### 11.1.4.6 Pressure Relief Valve Drainage Pipework

- Connect a drain hose to the pressure relief valve hose outlet.
- This hose must be installed in a continuously downward direction and in a frost-free environment.
- Guides this hose's outlet to outdoor only.
- Do not insert this hose into sewage hose or cleaning hose that may generate ammonia gas, sulfuric gas, etc.
- If necessary, use hose clamp to further tighten the hose at drain hose connector to prevent leakage.
- Water will drip from this hose, therefore the outlet of this hose must be installed in an area where the outlet cannot become blocked.

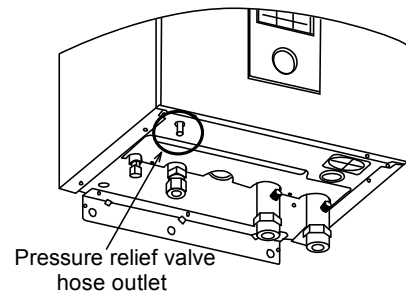

### 11.1.5 Connect The Cable To The Indoor Unit

<b>⚠ WARNING</b>
This section is for authorised and licensed electrician only. Work behind the Control Board Cover ⑥ secured by screws must only be carried out under supervision of qualified contractor, installation engineer or service person.

#### 11.1.5.1 Open the Control Board Cover ⑥

Please follow the steps below to open control board cover. Before opening the control board cover of indoor unit, always switch off all power supply (i.e. indoor unit power supply, heater power supply and Tank Unit power supply).

1. Remove the 6 mounting screws at the control board cover.
2. Swing the control board cover to the right hand side.



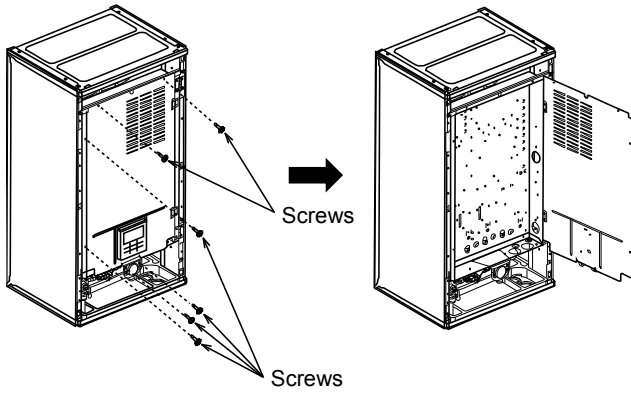

### 11.1.5.2 Fixing of Power Supply Cord and Connecting Cable

- Connecting cable between Indoor Unit and Outdoor Unit shall be approved polychloroprene sheathed  $4 \times \text{min } 4.0 \text{ mm}^2$  flexible cord, type designation 60245 IEC 57 or heavier cord.
  - Ensure the colour of wires of Outdoor Unit and the terminal no. are the same to the Indoor Unit respectively.
  - Earth wire shall be longer than other wires as shown in the figure for the electrical safety in case of the slipping out of the cord from the Holder (Clamper).
- An isolating device must be connected to the power supply cable.
  - Isolating device (disconnecting means) should have minimum 3.0 mm contact gap.
  - Connect the approved polychloroprene sheathed power supply 1 cord and power supply 2 cord and type designation 60245 IEC 57 or heavier cord to the terminal board, and to the other end of the cord to isolating device (Disconnecting means). See below table for cable size requirement.

Power Supply Cord	Cable Size	Isolating Devices	Recommended RCD
1	$3 \times \text{min } 4.0 \text{ mm}^2$	30A	30mA, 2P, type A
2	$3 \times \text{min } 4.0 \text{ mm}^2$	30A	30mA, 2P, type A

- To avoid the cable and cord being damaged by sharp edges, the cable and cord must be passed through a bushing (located at the bottom of Control Board) before terminal board. The bushing must be used and must not be removed.

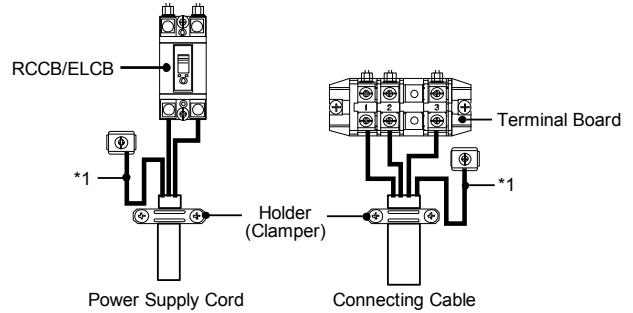
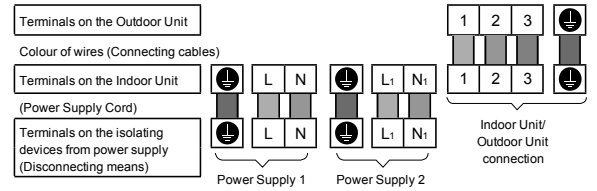

Terminal screw	Tightening torque cN·m {kgf·cm}
M4	157~196 {16~20}
M5	196~245 {20~25}

\*1 - Earth wire must be longer than other cables for safety reasons

### 11.1.5.3 Wire Stripping and Connecting Requirement

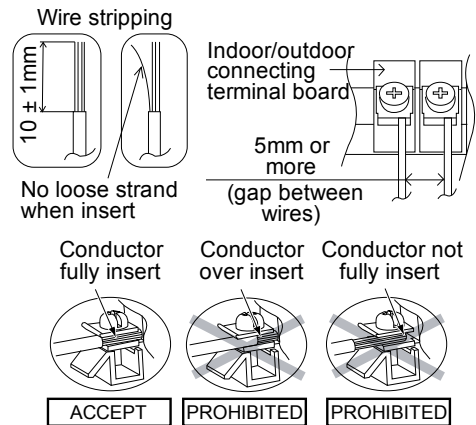

### 11.1.5.4 Connecting Requirement

For SXC09\*3E5/SXC12\*6E5

- The equipment's power supply 1 complies with IEC/EN 61000-3-12 provided that the short circuit power  $S_{SC}$  is greater than or equal to 1700kW at the interface point between the user's supply and the public system. It is the responsible of the installer or user of the equipment to ensure, by consultation with the distribution network operator if necessary, that the equipment is connected only to a supply with a short short circuit power  $S_{SC}$  greater than or equal to 1700kW.
- The equipment's power supply 1 complies with IEC/EN 61000-3-11 and shall be connected to a suitable supply net work, having service current capacity  $\geq 100A$  per phase. Please liaise with supply authority that the service current capacity at the interface point is sufficient for the installation of the equipment.
- The equipment's power supply 2 complies with IEC/EN 61000-3-12.
- The equipment's power supply 2 complies with IEC/EN 61000-3-11 and shall be connected to suitable supply network, with the following maximum permissible system impedance  $Z_{max} = 0.271\Omega$  at the interface. Please liaise with supply authority to ensure that the power supply 2 is connected only to a supply of that impedance or less.

### 11.1.6 Installation Of Remote Controller As Room Thermostat

- Remote Controller ③ mounted to the Indoor Unit can be moved to the room and serve as Room Thermostat.

#### 11.1.6.1 Installation Location

- Install at the height of 1 to 1.5 m from the floor (Location where average room temperature can be detected).
- Install vertically against the wall.
- Avoid the following locations for installation.
  1. By the window, etc. exposed to direct sunlight or direct air.
  2. In the shadow or backside of objects deviated from the room airflow.
  3. Location where condensation occurs (The Remote Controller is not moisture proof or drip proof.)
  4. Location near heat source.
  5. Uneven surface.
- Keep distance of 1 m or more from the TV, radio and PC. (Cause of fuzzy image or noise)

### 11.1.6.2 Remote Controller Wiring

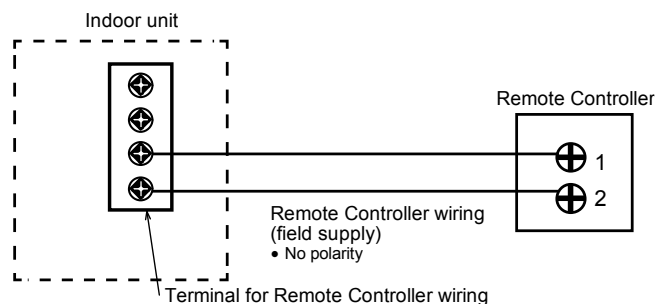

- Remote Controller cable shall be  $(2 \times \text{min } 0.3 \text{ mm}^2)$ , of double insulation PVC-sheathed or rubber sheathed cable. Total cable length shall be 50 m or less.
- Be careful not to connect cables to other terminals of Indoor Unit (e.g. power source wiring terminal). Malfunction may occur.
- Do not bundle together with the power source wiring or store in the same metal tube. Operation error may occur.

### 11.1.6.3 Remove The Remote Controller From Indoor Unit

1. Remove the top case from the bottom case.

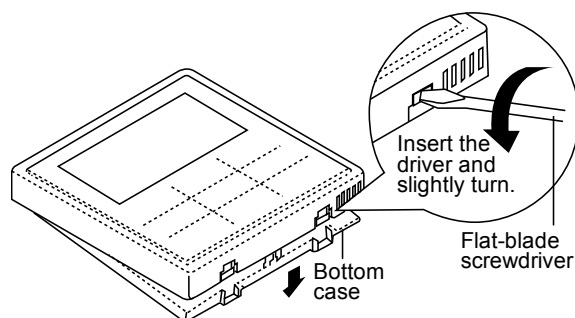

2. Remove the wiring between Remote controller and Indoor Unit terminal. Remove the bottom case from the Control board cover by loosening the screws. (3 pieces)

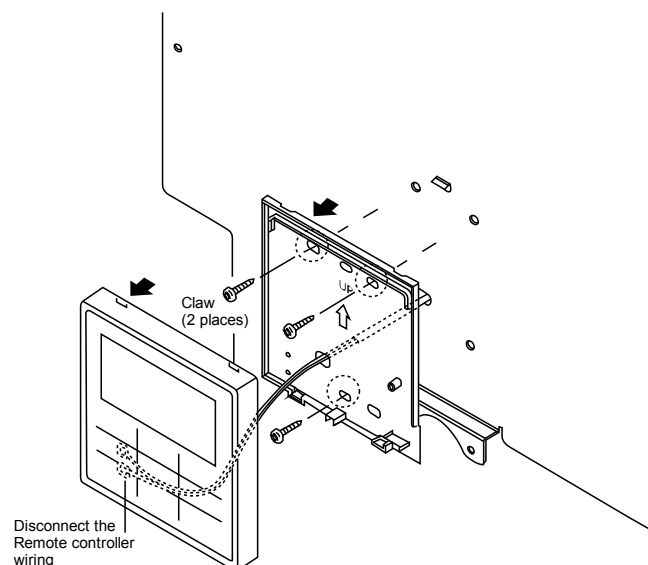

### 11.1.6.4 Mounting The Remote Controller

For exposed type

**Preparation:** Make 2 holes for screws using a driver.

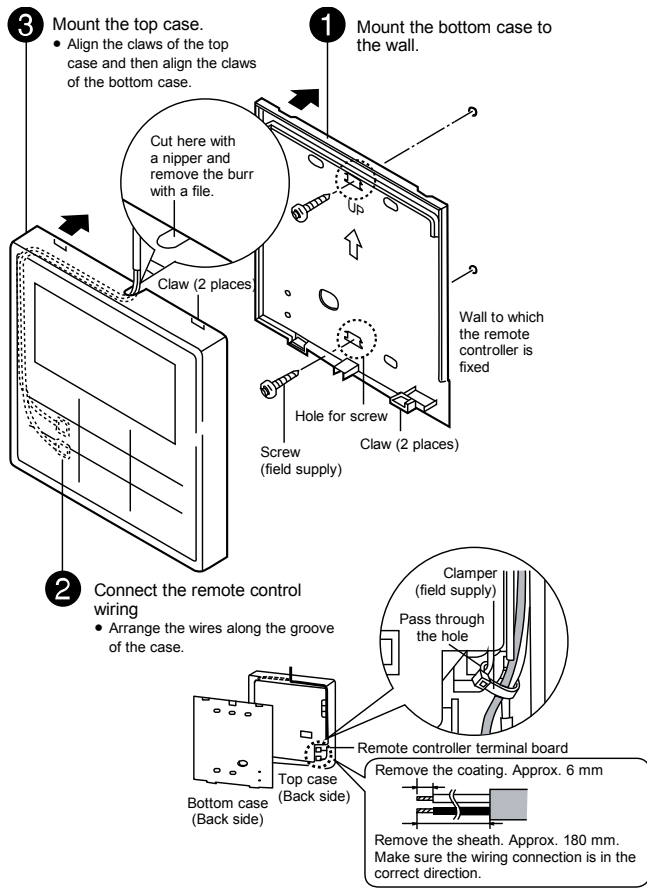

For embedded type

**Preparation:** Make 2 holes for screws using a driver.

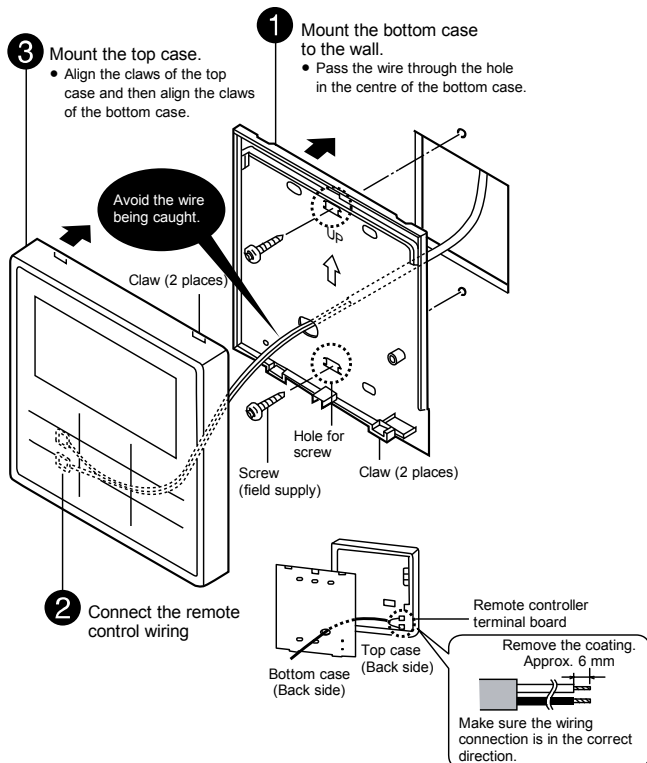

### 11.1.6.5 Replace The Remote Controller Cover

- Replace the existing Remote controller cover with Remote controller cover ⑥ to close the hole left after remove the Remote controller.

- Release the Remote controller cover's hooks from behind the front plate.

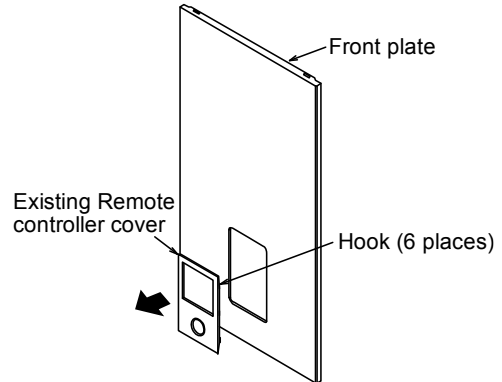

- Press from front to fix the Remote controller cover ⑥ on the front plate.

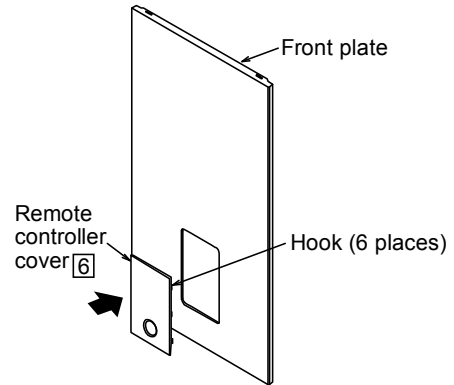

### 11.1.7 Charging The Water

- Make sure all the piping installations are properly done before carry out below steps.

- Turn the plug on the Air Purge Valve ⑨ outlet anticlockwise by one complete turn from fully closed position.

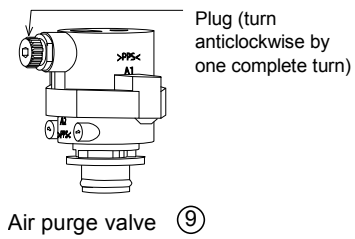



2. Set the Pressure Relief Valve ⑬ level "DOWN".

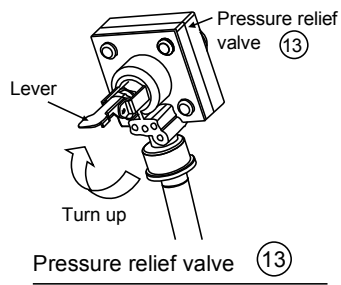

3. Start filling water (with pressure more than 0.1 MPa (1 bar)) to the Indoor Unit via water inlet. Stop filling water if the free water flow through Pressure Relief Valve drain hose.
4. Turn ON the power supply and make sure Water Pump ⑯ is running.
5. Check and make sure no water leaking at the tube connecting points.

## 11.2 Variation of system

This section introduces variation of various systems using Air-To-Water Heatpump and actual setting method.

### 11.2.1 Introduce application related to temperature setting.

#### 11.2.1.1 Temperature setting variation for heating

##### 1. Remote Controller

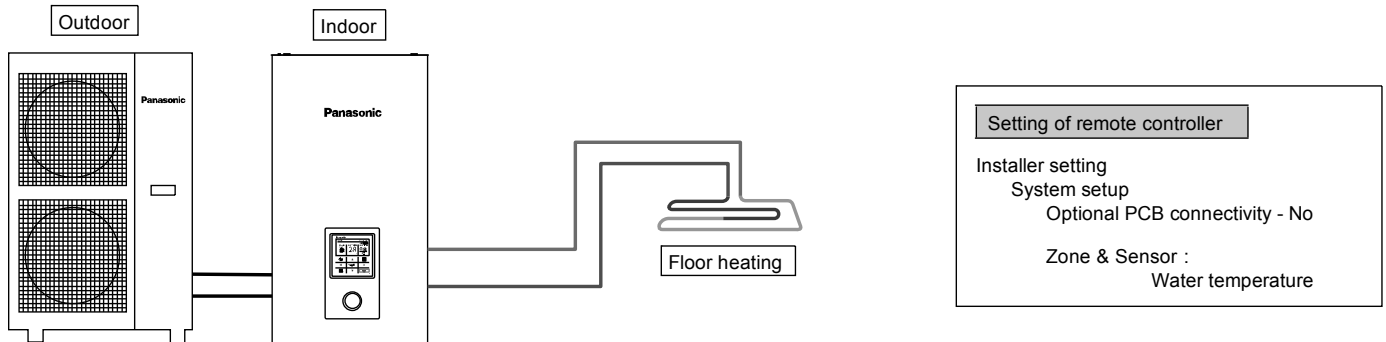

Connect floor heating or radiator directly to the indoor unit.  
Remote controller is installed on indoor unit.  
This is the basic form of the most simple system.

##### 2. Room Thermostat

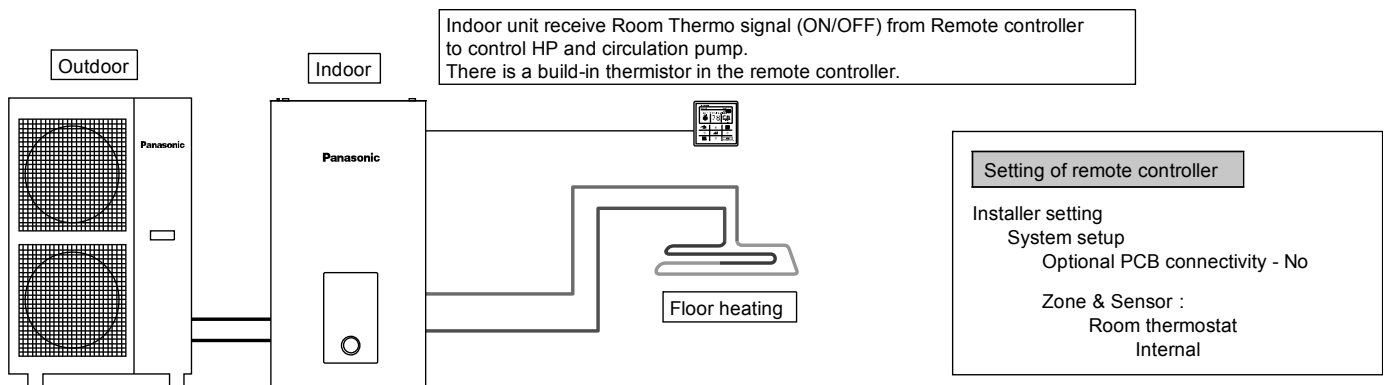

Connect floor heating or radiator directly to the indoor unit.  
Remove remote controller from indoor unit and install it in the room where floor heating is installed.  
This is an application that uses remote controller as Room Thermostat.

##### 3. External Room Thermostat

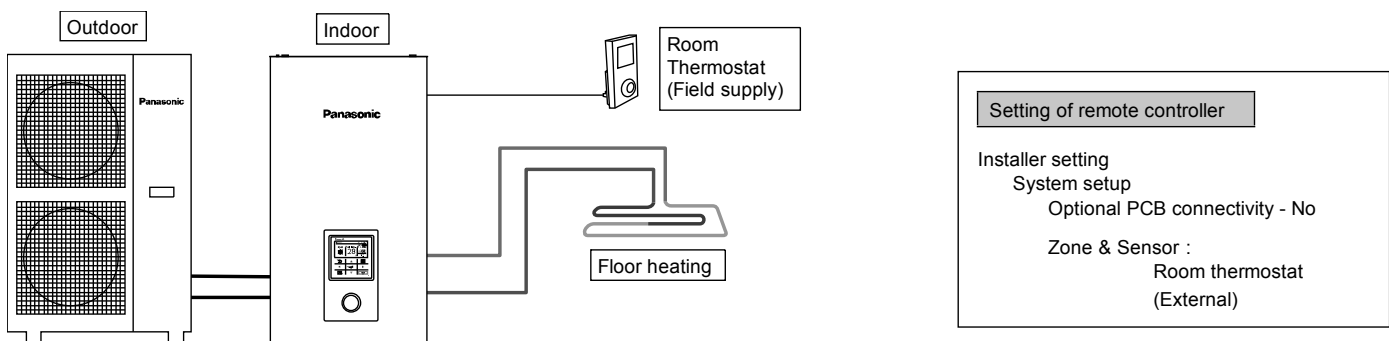

Connect floor heating or radiator directly to indoor unit.  
Remote controller is installed on indoor unit.  
Install separate external Room Thermostat (field supply) in the room where floor heating is installed.  
This is an application that uses external Room Thermostat.

#### 4. Room Thermistor

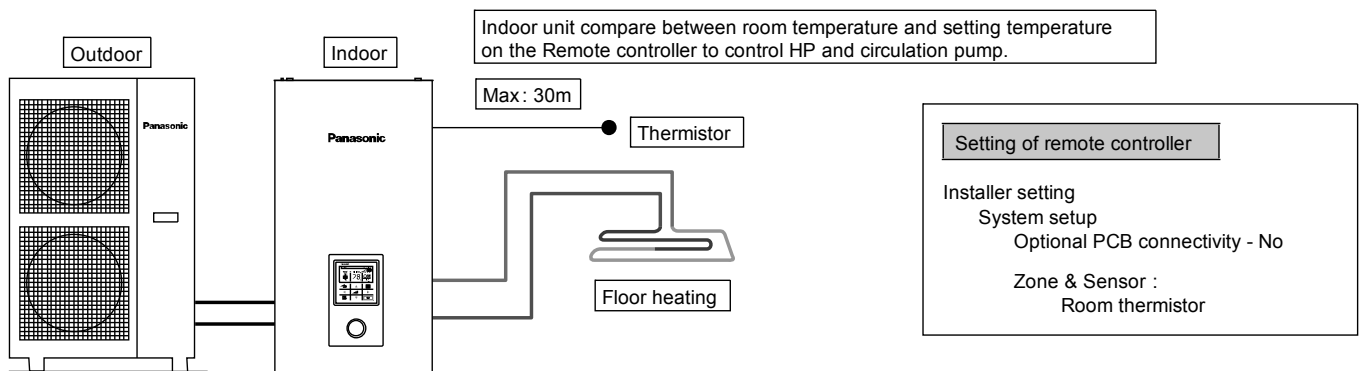

Connect floor heating or radiator directly to indoor unit.

Remote controller is installed on indoor unit.

Install separate external room thermistor (specified by Panasonic) in the room where floor heating is installed.

This is an application that uses external room thermistor.

There are 2 kinds of circulation water temperature setting method.

Direct: set direct circulation water temperature (fixed value)

Compensation curve: set circulation water temperature depends on outdoor ambient temperature

In case of Room thermo or Room thermistor, compensation curve can be set.

In this case, compensation curve is shifted according to the thermo ON/OFF situation.

- (Example) If room temperature increasing speed is;  
very slow → shift up the compensation curve  
very fast → shift down the compensation curve

#### 11.2.1.2 Examples of installations

##### Floor heating 1 + Floor heating 2

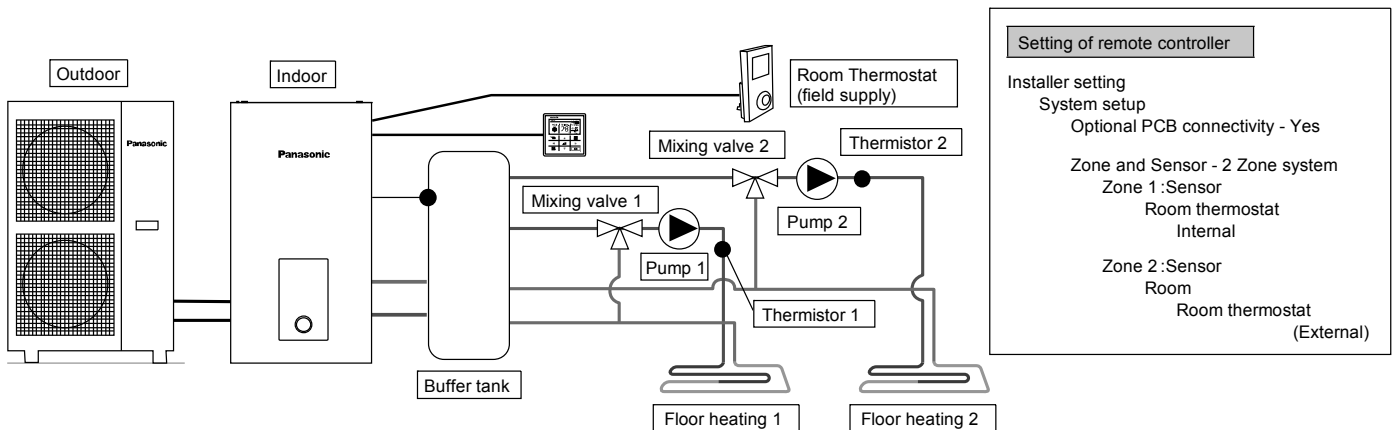

Connect floor heating to 2 circuits through buffer tank as shown in the figure.

Install mixing valves, pumps and thermistors (specified by Panasonic) on both circuits.

Remove remote controller from indoor unit, install it in one of the circuit and use it as Room Thermostat.

Install external Room Thermostat (field supply) in another circuit.

Both circuits can set circulation water temperature independently.

Install buffer tank thermistor on buffer tank.

It requires connection setting of buffer tank and  $\Delta T$  temperature setting at heating operation separately.

This system requires optional PCB (CZ-NS4P).

## Floor heating + Radiator

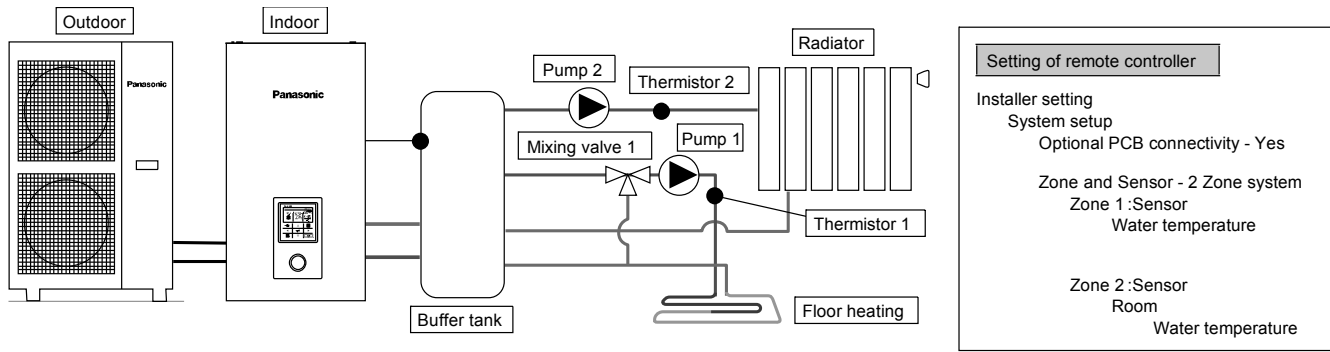

Connect floor heating or radiator to 2 circuits through buffer tank as shown in figure.

Install pumps and thermistors (specified by Panasonic) on both circuits.

Install mixing valve in the circuit with lower temperature among the 2 circuits.

(Generally, if install floor heating and radiator circuit at 2 zones, install mixing valve in floor heating circuit.)

Remote controller is installed on indoor unit.

For temperature setting, select circulation water temperature for both circuits.

Both circuits can set circulation water temperature independently.

Install buffer tank thermistor on buffer tank.

It requires connection setting of buffer tank and  $\Delta T$  temperature setting at heating operation separately.

This system requires the optional PCB (CZ-NS4P).

Mind that if there is no mixing valve at the secondary side, the circulation water temperature may get higher than setting temperature.

## Floor heating + Swimming pool

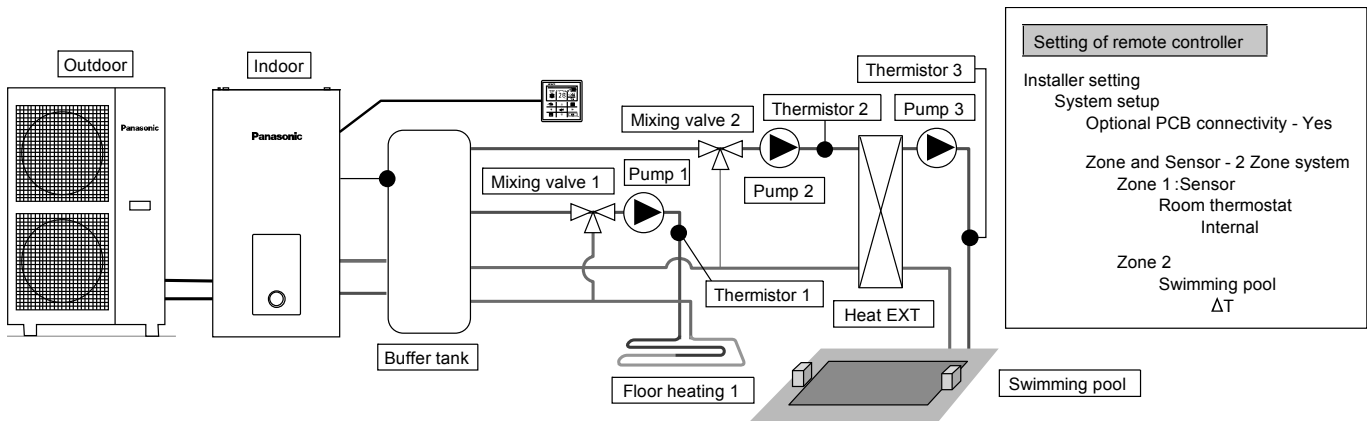

Connect floor heating and swimming pool to 2 circuits through buffer tank as shown in figure.

Install mixing valves, pumps and thermistors (specified by Panasonic) on both circuits.

Then, install additional pool heat exchanger, pool pump and pool sensor on pool circuit.

Remove remote controller from indoor unit and install in room where floor heating is installed. Circulation water temperature of floor heating and swimming pool can be set independently.

Install buffer tank sensor on buffer tank.

It requires connection setting of buffer tank and  $\Delta T$  temperature setting at heating operation separately. This system requires the optional PCB (CZ-NS4P).

\* Must connect swimming pool to "Zone 2".

If it is connected to swimming pool, operation of pool will stop when "Cooling" is operated.

## Swimming pool only

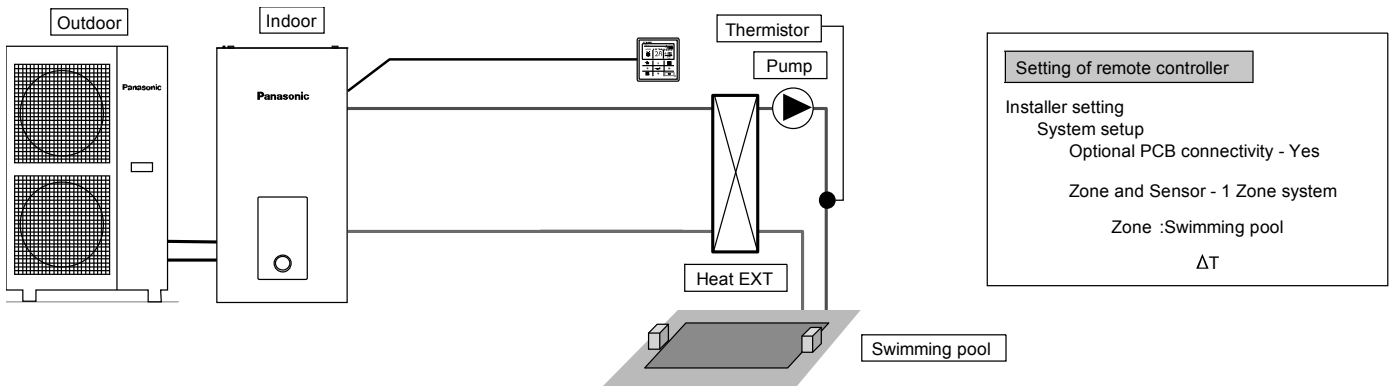

This is an application that connects to the swimming pool only.  
 Connects pool heat exchanger directly to indoor unit without using buffer tank.  
 Install pool pump and pool sensor (specified by Panasonic) at secondary side of the pool heat exchanger.  
 Remove remote controller from indoor unit and install in room where floor heating is installed.  
 Temperature of swimming pool can be set independently.  
 This system requires the optional PCB (CZ-NS4P).

In this application, cooling mode cannot be selected. (not display on remote controller)

## Simple 2 zone (Floor heating + Radiator)

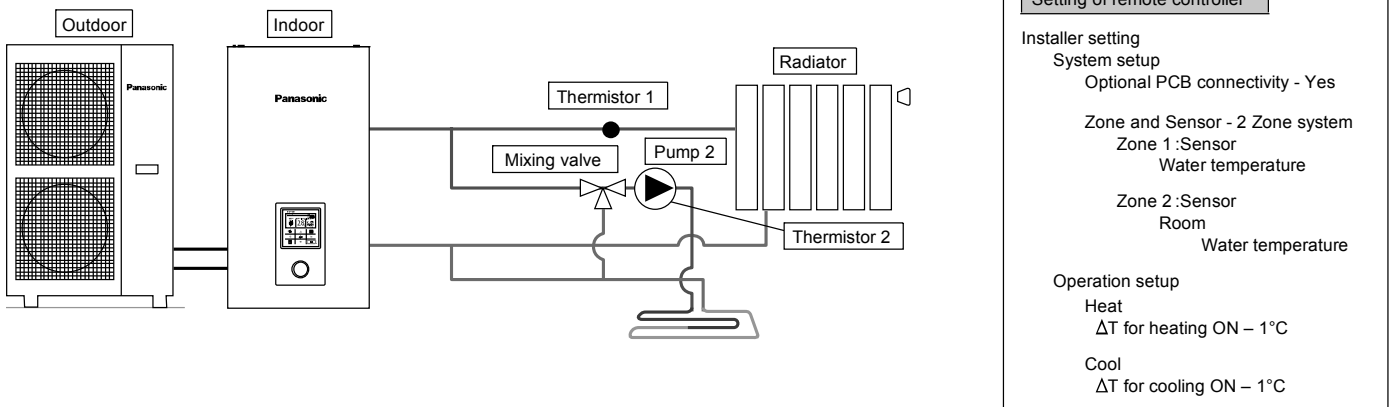

This is an example of simple 2 zone control without using buffer tank.  
 Built-in pump from indoor unit served as a pump in zone 1.  
 Install mixing valve, pump and thermistor (specified by Panasonic) on zone 2 circuit.  
 Please be sure to assign high temperature side to zone 1 as temperature of zone 1 cannot be adjusted.  
 Zone 1 thermistor is required to display temperature of zone 1 on remote controller.  
 Circulation water temperature of both circuits can be set independently.  
 (However, temperature of high temperature side and low temperature side cannot be reversed)  
 This system requires the optional PCB (CZ-NS4P).

### (CAUTION)

- Thermistor 1 does not affect operation directly. But error happens if it is not installed.
- Please adjust flow rate of zone 1 and zone 2 to be in balance. If it is not adjusted correctly, it may affect the performance.  
 (If zone 2 pump flow rate is too high, there is possibility that no hot water flowing to zone 1.)  
 Flow rate can be confirmed by "Actuator Check" from maintenance menu.

## 11.2.2 Introduce applications of system that uses optional equipment.

### DHW (Domestic Hot Water) Tank connection

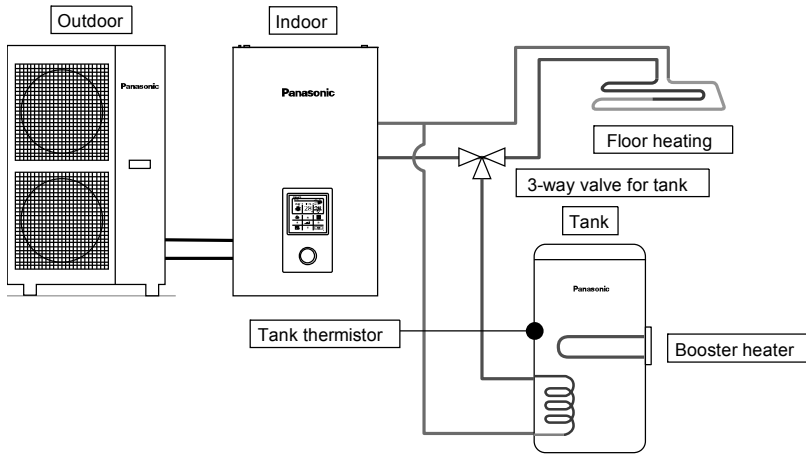

Setting of remote controller
Installer setting
System setup
Optional PCB connectivity - No
Tank connection - Yes

This is an application that connects the DHW tank to the indoor unit through 3-way valve. DHW tank's temperature is detected by tank thermistor (specified by Panasonic).

### Tank + Solar connection

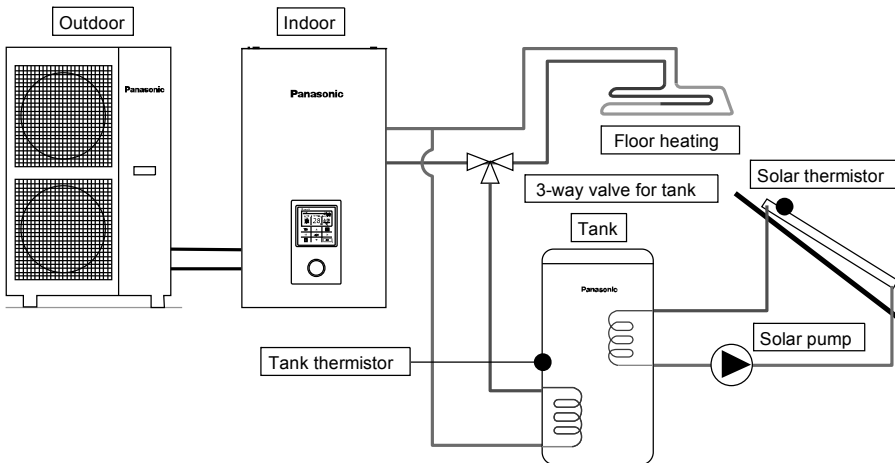

Setting of remote controller
Installer setting
System setup
Optional PCB connectivity - Yes
Tank connection - Yes
Solar connection - Yes
DHW tank
$\Delta T$ turn ON
$\Delta T$ turn OFF
Antifreeze
Hi limit

This is an application that connects the DHW tank to the indoor unit through 3-way valve before connect the solar water heater to heat up the tank. DHW tank's temperature is detected by tank thermistor (specified by Panasonic). Solar panel's temperature is detected by solar thermistor (specified by Panasonic).

DHW tank shall use tank with built-in solar heat exchange coil independently.

Heat accumulation operates automatically by comparing the temperature of tank thermistor and solar thermistor.

During winter season, solar pump for circuit protection will be activated continuously. If does not want to activate the solar pump operation, please use glycol and set the anti-freezing operation start temperature to  $-20^{\circ}\text{C}$ .

This system requires optional PCB (CZ-NS4P).

### Buffer tank connection

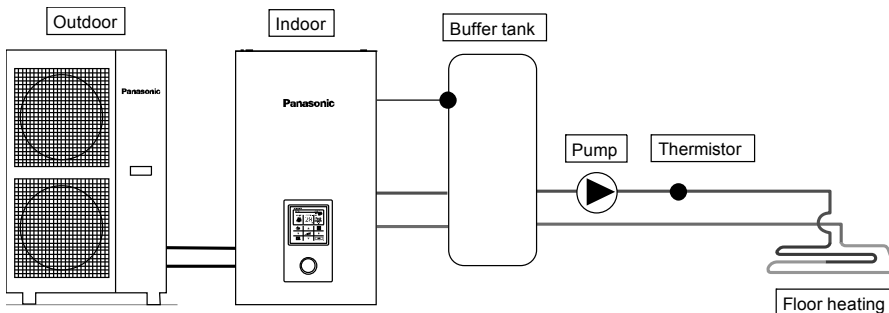

Setting of remote controller
Installer setting
System setup
Optional PCB connectivity - Yes
Buffer Tank connection - Yes
$\Delta T$ for buffer tank

This is an application that connects the buffer tank to the indoor unit.

Buffer tank's temperature is detected by buffer tank thermistor (specified by Panasonic).

This system requires optional PCB (CZ-NS4P).

## Buffer tank + Solar

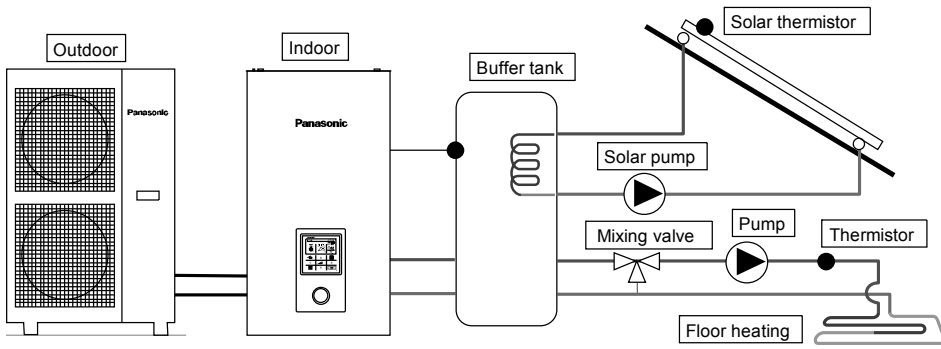

Setting of remote controller	
Installer setting	
System setup	
Optional PCB connectivity	- Yes
Buffer Tank connection	- Yes
ΔT for buffer tank	
Solar connection	- Yes
Buffer tank	
ΔT turn ON	
ΔT turn OFF	
Antifreeze	
Hi limit	

This is an application that connects the buffer tank to the indoor unit before connecting to the solar water heater to heat up the tank.

Buffer tank's temperature is detected by buffer tank thermistor (specified by Panasonic).

Solar panel's temperature is detected by solar thermistor (specified by Panasonic).

Buffer tank shall use tank with built-in solar heat exchange coil independently.

During winter season, solar pump for circuit protection will be activated continuously. If does not want to activate the solar pump operation, please use glycol and set the anti-freezing operation start temperature to -20°C.

Heat accumulation operates automatically by comparing the temperature of tank thermistor and solar thermistor.

This system requires optional PCB (CZ-NS4P).

## Boiler connection

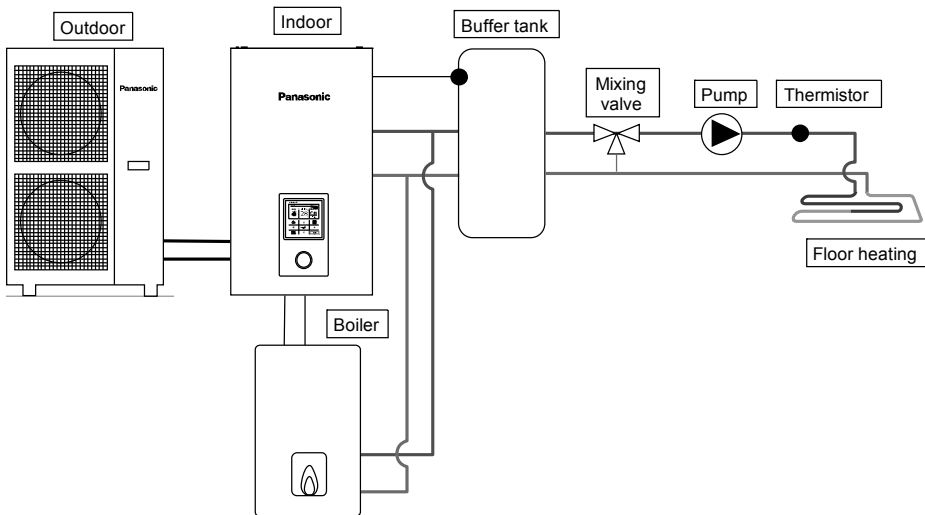

Setting of remote controller	
Installer setting	
System setup	
Optional PCB connectivity	- Yes
Bivalent	- Yes
Turn ON : outdoor temp	
Control pattern	

This is an application that connects the boiler to the indoor unit, to compensate for insufficient capacity by operate boiler when outdoor temperature drops & heat pump capacity is insufficient.

Boiler is connected parallel with heat pump against heating circuit.

There are 3 modes selectable by remote controller for boiler connection.

Besides that, an application that connects to the DHW tank's circuit to heat up tank's hot water is also possible.

(Operation setting of boiler shall be responsible by installer.)

This system requires optional PCB (CZ-NS4P).

Depending on the settings of the boiler, it is recommended to install buffer tank as temperature of circulating water may get higher. (It must connect to buffer tank especially when selecting Advanced Parallel setting.)

### WARNING

Panasonic is NOT responsible for incorrect or unsafe situation of the boiler system.

### CAUTION

Make sure the boiler and its integration in the system complies with applicable legislation.  
 Make sure the return water temperature from the heating circuit to the indoor unit does NOT exceed 55°C.  
 Boiler is turned off by safety control when the water temperature of the heating circuit exceed 85°C.

## 11.2.3 How To Fix Cable

### 11.2.3.1 Connecting with external device (optional)

- All connections shall follow to the local national wiring standard.
- It is strongly recommended to use manufacturer-recommended parts and accessories for installation.
- For connection to main PCB ④.
  1. Two-way valve shall be spring and electronic type, refer to “Field Supply Accessories” table for details. Valve cable shall be (3 × min 1.5 mm<sup>2</sup>), of type designation 60245 IEC 57 or heavier, or similarly double insulation sheathed cable.
    - \* note: - Two-way Valve shall be CE marking compliance component.
    - Maximum load for the valve is 9.8VA.
  2. Three-way valve shall be spring and electronic type. Valve cable shall be (3 × min 1.5 mm<sup>2</sup>), of type designation 60245 IEC 57 or heavier, or similarly double insulation sheathed cable.
    - \* note: - Shall be CE marking compliance component.
    - It shall be directed to heating mode when it is OFF.
    - Maximum load for the valve is 9.8VA.
  3. Room thermostat cable must be (4 or 3 × min 0.5 mm<sup>2</sup>), of type designation 60245 IEC 57 or heavier cord, or similarly double insulation sheathed cable.
  4. Maximum output power of booster heater shall be ≤ 3 kW. Booster heater cable must be (3 × min 1.5 mm<sup>2</sup>), of type designation 60245 IEC 57 or heavier.
  5. Extra pump cable shall be (2 × min 1.5 mm<sup>2</sup>), of type designation 60245 IEC 57 or heavier.
  6. Boiler contact cable shall be (2 × min 0.5 mm<sup>2</sup>), of type designation 60245 IEC 57 or heavier.
  7. External control shall be connected to 1-pole switch with min 3.0 mm contact gap. Its cable must be (2 × min 0.5 mm<sup>2</sup>), double insulation layer of PVC-sheathed or rubber-sheathed cable.
    - \* note: - Switch used shall be CE compliance component.
    - Maximum operating current shall be less than 3A<sub>rms</sub>.
  8. Tank sensor shall be resistance type, please refer to Graph 7.1 for the characteristic and details of sensor. Its cable shall be (2 × min 0.3 mm<sup>2</sup>), double insulation layer (with insulation strength of min 30V) of PVC-sheathed or rubber-sheathed cable.

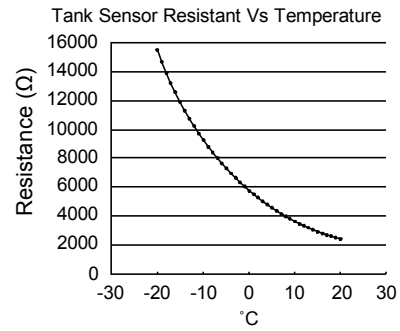

Tank sensor characteristic

9. Room sensor zone 1 cable shall be (2 × min 0.3 mm<sup>2</sup>) double insulation layer of PVC-sheathed or rubber-sheathed.
10. Outdoor air sensor cable shall be (2 × min 0.3 mm<sup>2</sup>) double insulation layer of PVC-sheathed or rubber-sheathed.
11. Tank OLP cable must be (2 × min 0.5 mm<sup>2</sup>), double insulation layer of PVC-sheathed or rubber-sheathed cable.

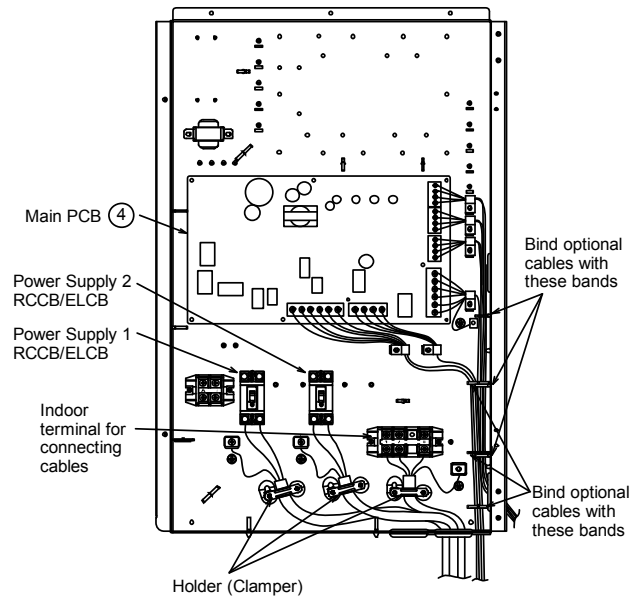

How to guide the optional cables and power supply cord (view without internal wiring)

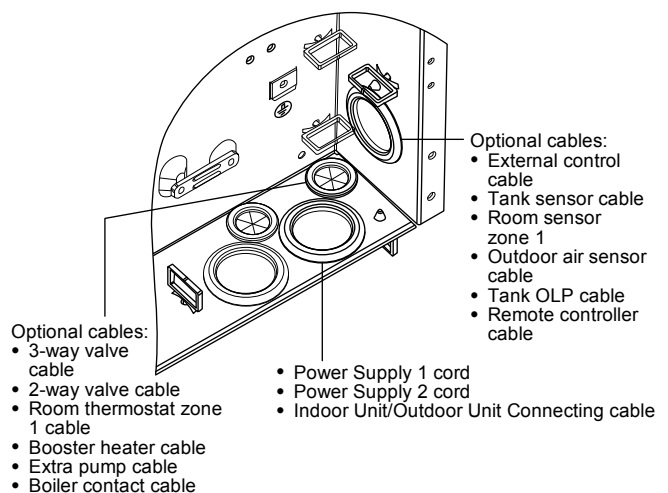



- For connection to optional PCB 7
- By connecting optional PCB, 2 Zone temperature control can be achieved. Please connect mixing valves, water pumps and thermistors in zone 1 and zone 2 to each terminals in optional PCB. Temperature of each zone can be controlled independently by remote controller.
  - Pump zone 1 and zone 2 cable shall be (2 × min 1.5 mm<sup>2</sup>), of type designation 60245 IEC 57 or heavier.
  - Solar pump cable shall be (2 × min 1.5 mm<sup>2</sup>), of type designation 60245 IEC 57 or heavier.
  - Pool pump cable shall be (2 × min 1.5 mm<sup>2</sup>), of type designation 60245 IEC 57 or heavier.
  - Room thermostat zone 1 and zone 2 cable shall be (4 × min 0.5 mm<sup>2</sup>), of type designation 60245 IEC 57 or heavier.
  - Mixing valve zone 1 and zone 2 cable shall be (3 × min 1.5 mm<sup>2</sup>), of type designation 60245 IEC 57 or heavier.
  - Room sensor zone 1 and zone 2 cable shall be (2 × min 0.3 mm<sup>2</sup>), double insulation layer (with insulation strength of minimum 30V) of PVC-sheathed or rubber-sheathed cable.
  - Buffer tank sensor, pool water sensor and solar sensor cable shall be (2 × min 0.3 mm<sup>2</sup>), double insulation layer (with insulation strength of minimum 30V) of PVC-sheathed or rubber-sheathed cable.
  - Water sensor zone 1 and zone 2 cable shall be (2 × min 0.3 mm<sup>2</sup>), double insulation layer of PVC-sheathed or rubber-sheathed cable.
  - Demand signal cable shall be (2 × min 0.3 mm<sup>2</sup>), double insulation layer of PVC-sheathed or rubber-sheathed cable.
  - SG signal cable shall be (3 × min 0.3 mm<sup>2</sup>), double insulation layer of PVC-sheathed or rubber-sheathed cable.
  - Heat/Cool switch cable shall be (2 × min 0.3 mm<sup>2</sup>), double insulation layer of PVC-sheathed or rubber-sheathed cable.
  - External compressor switch cable shall be (2 × min 0.3 mm<sup>2</sup>), double insulation layer of PVC-sheathed or rubber-sheathed cable.

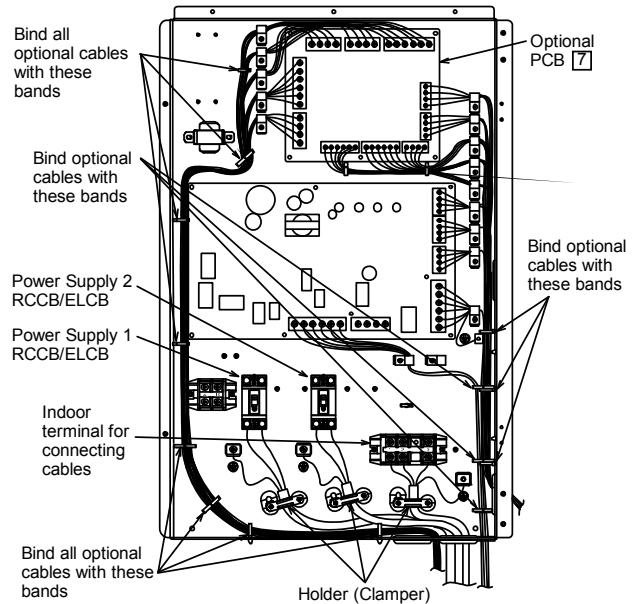

How to guide the optional cables and power supply cord (view without internal wiring)

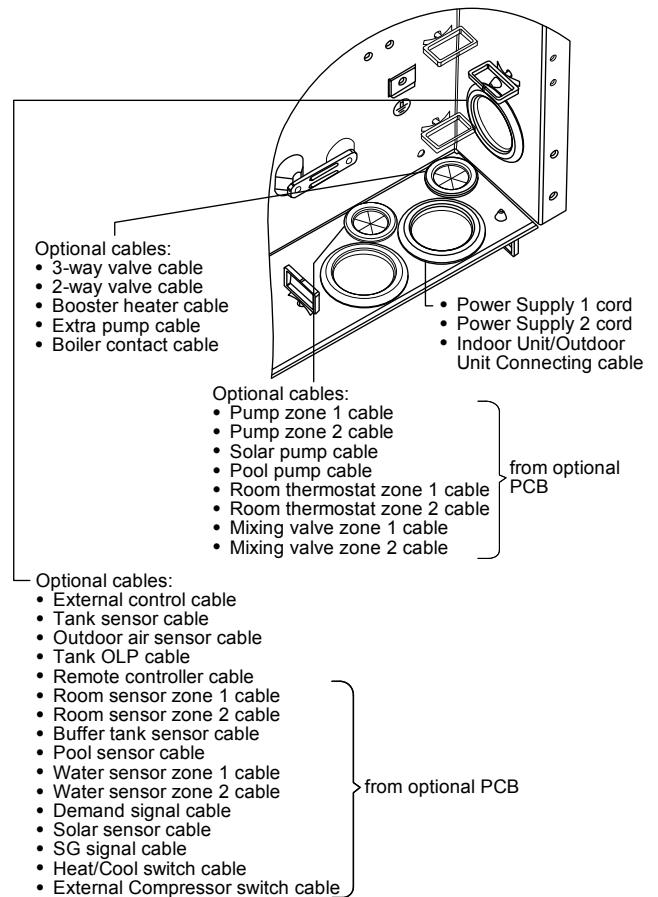

Terminal screw on PCB	Maximum tightening torque cN•m {kgf•cm}
M3	50 {5.1}
M4	120 {12.24}

### 11.2.3.2 Connecting Cables Length

When connecting cables between Indoor Unit and external devices, the length of the said cables must not exceed the maximum length as shown in the table.

External device	Maximum cables length (m)
Two-way valve	50
Three-way valve	50
Mixing valve	50
Room thermostat	50
Booster heater	50
Extra pump	50
Solar pump	50
Pool pump	50
Pump	50
Boiler contact	50
External control	50
Tank sensor	30
Room sensor	30
Outdoor air sensor	30
Tank OLP	30
Buffer tank sensor	30
Pool water sensor	30
Solar sensor	30
Water sensor	30
Demand signal	50
SG signal	50
Heat/Cool switch	50
External compressor switch	50

### 11.2.3.3 Connection of the main PCB

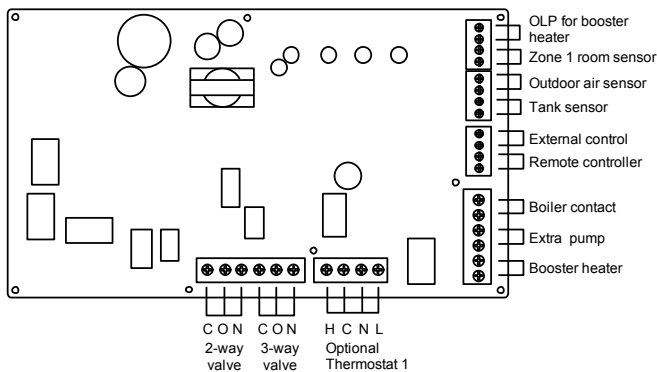

#### ■ Signal inputs

Optional Thermostat	L N =AC230V, Heat, Cool=Thermostat heat, Cool terminal * It does not function when using the optional PCB
OLP for booster heater	Dry contact Vcc-Bit1, Vcc-Bit2 open/short (System setup necessary) It is connected to the safety device (OLP) of DHW tank.
External control	Dry contact Open=not operate, Short=operate (System setup necessary) Able to turn ON/OFF the operation by external switch
Remote controller	Connected (Please use 2 cores wire for relocation and extension. Total cable length shall be 50m or less.)

#### ■ Outputs

3-way valve	AC230V N=Neutral Open, Close=direction (For circuit switching when connected to DHW tank)
2-way valve	AC230V N=Neutral Open, Close (Prevent water circuit pass through during cooling mode)
Extra pump	AC230V (Used when indoor unit pump capacity is insufficient)
Booster heater	AC230V (Used when using booster heater in DHW tank)
Boiler contact	Dry contact (System setup necessary)

#### ■ Thermistor inputs

Zone 1 room sensor	PAW-A2W-TSRT * It does not work when using the optional PCB
Outdoor air sensor	AW-A2W-TSOD (Total cable length shall be 30m or less)
Tank sensor	Please use Panasonic specified part

### 11.2.3.4 Connection of Optional PCB (CZ-NS4P)

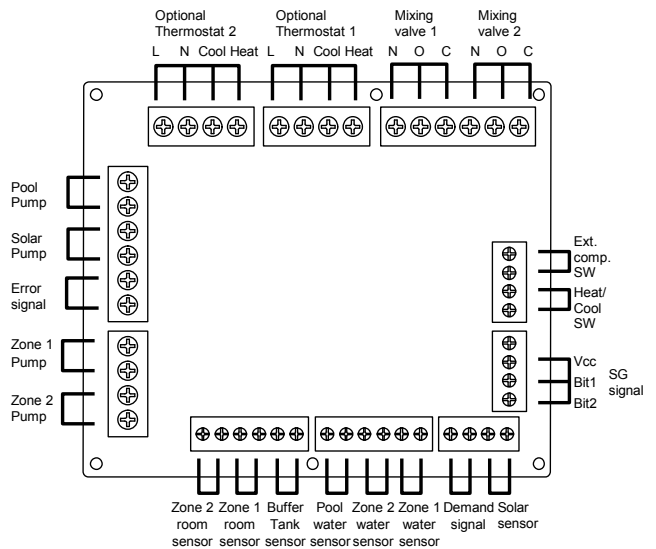

#### ■ Signal inputs

Optional Thermostat	L N =AC230V, Heat, Cool=Thermostat heat, Cool terminal
SG signal	Dry contact Vcc-Bit1, Vcc-Bit2 open/short (System setup necessary) Switching SW (Please connect to the 2 contacts controller)
Heat/Cool SW	Dry contact Open=Heat, Short=Cool (System setup necessary)
External comp. SW	Dry contact Open=Comp.ON, Short=Comp.OFF (System setup necessary)
Demand signal	DC 0~10V (System setup necessary) Please connect to the DC 0~10V controller.

## ■ Outputs

Mixing valve	AC230V N=Neutral Open, Close=mixture direction Operating time: 30s~120s
Pool pump	AC230V
Solar pump	AC230V
Zone pump	AC230V

## ■ Thermistor inputs

Zone room sensor	PAW-A2W-TSRT
Buffer tank sensor	PAW-A2W-TSBU
Pool water sensor	PAW-A2W-TSHC
Zone water sensor	PAW-A2W-TSHC
Solar sensor	PAW-A2W-TSSO

### 11.2.3.5 Recommended External Device Specification

- This section explains about the external devices (optional) recommended by Panasonic. Please always ensure to use the correct external device during system installation.
  - For optional sensor.
1. Buffer tank sensor: PAW-A2W-TSBU  
Use for measurement of the buffer tank temperature.  
Insert the sensor into the sensor pocket and paste it on the buffer tank surface.

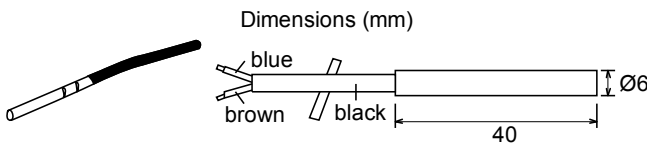

2. Zone water sensor: PAW-A2W-TSHC  
Use to detect the water temperature of the control zone.  
Mount it on the water piping by using the stainless steel metal strap and contact paste (both are included).

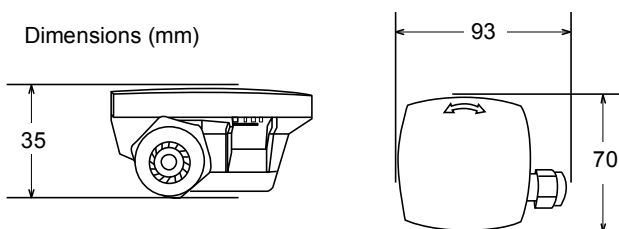

3. Outdoor sensor: PAW-A2W-TSOD  
If the installation location of the outdoor unit is exposed to direct sunlight, the outdoor air temperature sensor will be unable to measure the actual outdoor ambient temperature correctly. In this case, optional outdoor temperature sensor can be fixed at a suitable location to more accurately measure ambient temperature.

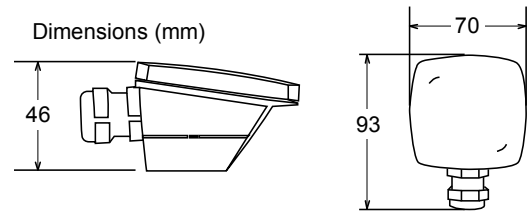

4. Room sensor: PAW-A2W-TSRT  
Install the room temperature sensor to the room which requires room temperature control.

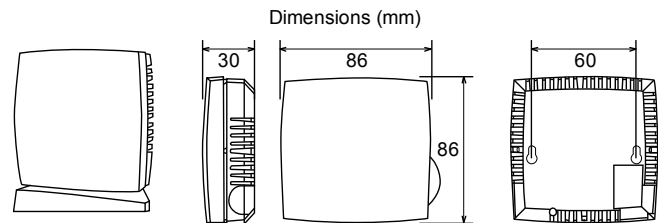

5. Solar sensor: PAW-A2W-TSSO  
Use for measurement of the solar panel temperature.  
Insert the sensor into the sensor pocket and paste it on the solar panel surface.

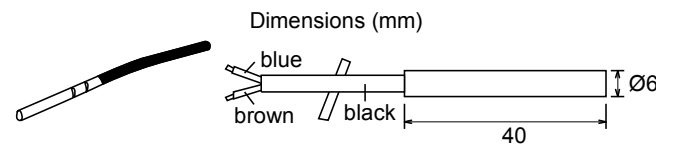

6. Please refer to the table below for sensor characteristic of the sensors mentioned above.

Temperature (°C)	Resistance (kΩ)
30	5.326
25	6.523
20	8.044
15	9.980
10	12.443
5	15.604
0	19.70
-5	25.05
-10	32.10
-15	41.45
-20	53.92
-25	70.53
-30	93.05
-35	124.24
-40	167.82

Temperature (°C)	Resistance (kΩ)
150	0.147
140	0.186
130	0.236
120	0.302
110	0.390
100	0.511
90	0.686
80	0.932
70	1.279
65	1.504
60	1.777
55	2.106
50	2.508
45	3.003
40	3.615
35	4.375

- For optional pump.  
Power supply: AC230V/50Hz, <500W  
Recommended part: Yonos 25/6: made by Wilo

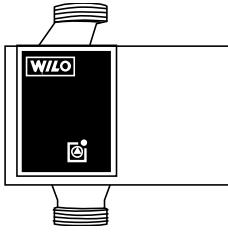

- For optional mixing valve.  
Power supply: AC230V/50Hz (input open/output close)  
Operating time: 30s~120s  
Recommended part: 167032: made by Caleffi

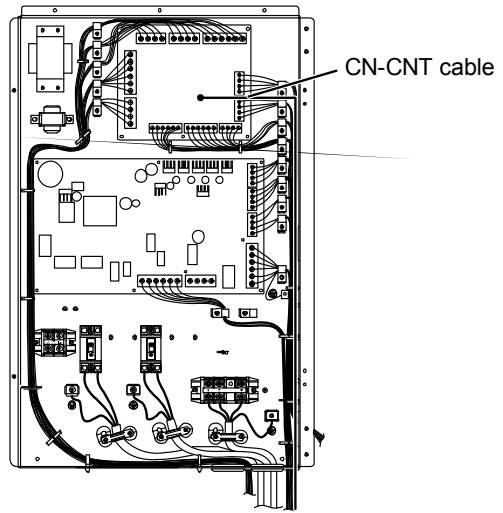
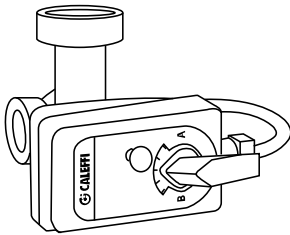

With Optional PCB

2. Insert a flat head screwdriver into the slot on the top of the adaptor and remove the cover. Connect the other end of the CN-CNT cable connector to the connector inside the adaptor.

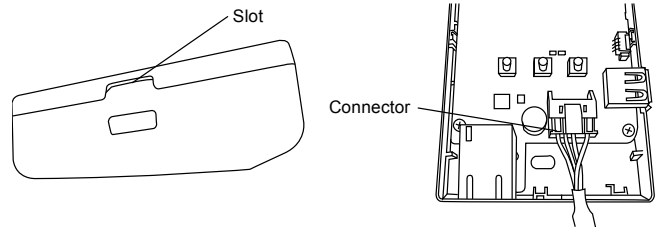

**⚠ WARNING**

This section is for authorized and licensed electrician/water system installer only. Work behind the front plate secured by screws must only be carried out under supervision of qualified contractor, installation engineer or service person.

### 11.2.3.6 Network Adaptor <sup>8</sup> Installation (Optional)

1. Open the Control Board Cover <sup>6</sup>, then connect the cable included with this adaptor to the CN-CNT connector on the printed circuit board.
- Pull the cable out of the Indoor Unit so that there is no pinching.
  - If an optional PCB has been install in the Indoor Unit, connect the CN-CNT connector to Optional PCB <sup>7</sup>.

3. On the wall near the Indoor Unit, attach the adaptor by screwing screws through the holes in the back cover.

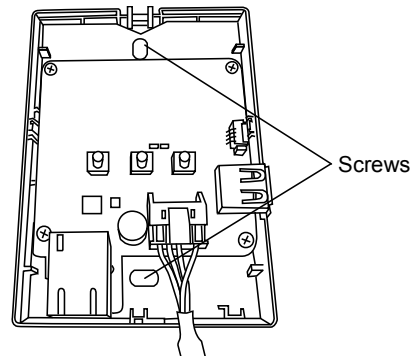

Connection examples: H series

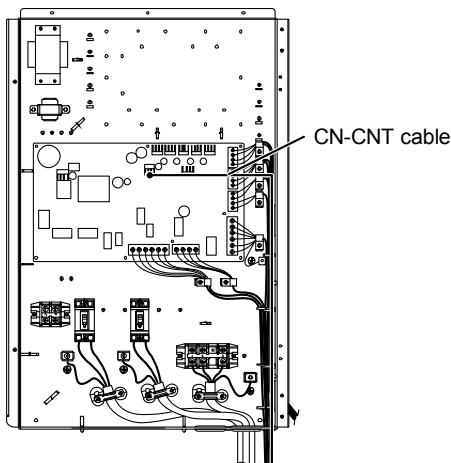

Without Optional PCB

4. Pull the CN-CNT cable through the hole in the bottom of the adaptor and re-attach the front cover to the back cover.

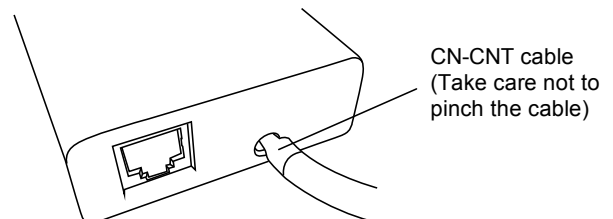

5. **Use the included cord clamp to fix the CN-CNT cable to the wall.**

Pull the cable around as shown in the diagram so that external forces cannot act on the connector in the adaptor.

Furthermore, on the Indoor Unit end, use the included cable tie to fix the cables together.

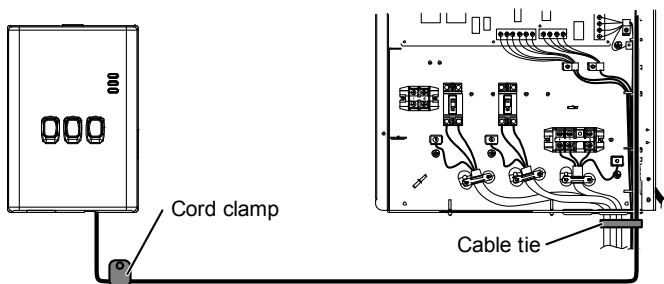

# 11.3 System Installation

## 11.3.1 Remote Controller Outline

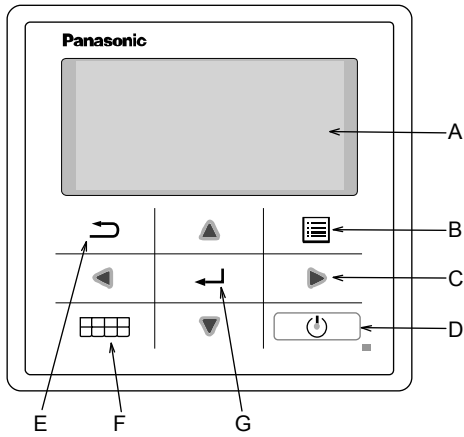

Name	Function
A: Main screen	Display information
B: Menu	Open/Close main menu
C: Triangle (Move)	Select or change item
D: Operate	Start/Stop operation
E: Back	Back to previous item
F: Quick Menu	Open/Close Quick menu
G: OK	Confirm

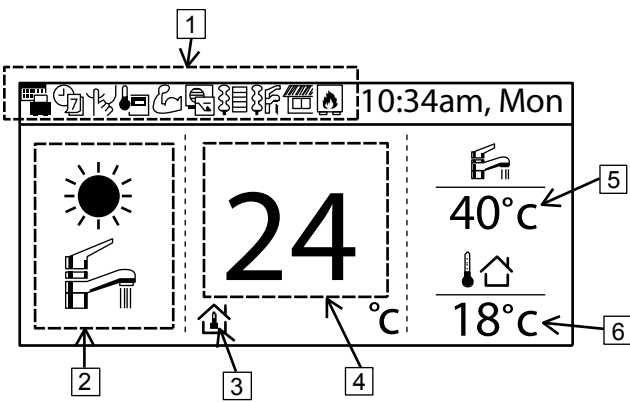

Name	Function												
1: Function icon	Display set function/status <table border="0" style="width: 100%;"> <tr> <td> Holiday mode</td> <td> Demand control</td> </tr> <tr> <td> Weekly timer</td> <td> Room heater</td> </tr> <tr> <td> Quiet mode</td> <td> Tank heater</td> </tr> <tr> <td> Remote controller room thermostat</td> <td> Solar</td> </tr> <tr> <td> Powerful mode</td> <td> Boiler</td> </tr> </table>	Holiday mode	Demand control	Weekly timer	Room heater	Quiet mode	Tank heater	Remote controller room thermostat	Solar	Powerful mode	Boiler		
Holiday mode	Demand control												
Weekly timer	Room heater												
Quiet mode	Tank heater												
Remote controller room thermostat	Solar												
Powerful mode	Boiler												
2: Mode	Display set mode/current status of mode <table border="0" style="width: 100%;"> <tr> <td> Heating</td> <td> Cooling</td> <td> Auto heating</td> <td> Auto cooling</td> </tr> <tr> <td> Auto</td> <td> Hot water supply</td> <td></td> <td></td> </tr> <tr> <td> Heap pump operating</td> <td></td> <td></td> <td></td> </tr> </table>	Heating	Cooling	Auto heating	Auto cooling	Auto	Hot water supply			Heap pump operating			
Heating	Cooling	Auto heating	Auto cooling										
Auto	Hot water supply												
Heap pump operating													
3: Temp setting	<table border="0" style="width: 100%;"> <tr> <td> Set room temp</td> <td> Compensation curve</td> <td> Set direct water temp</td> <td> Set pool temp</td> </tr> </table>	Set room temp	Compensation curve	Set direct water temp	Set pool temp								
Set room temp	Compensation curve	Set direct water temp	Set pool temp										
4: Display Heat temp	Display current heating temperature (it is set temperature when enclosed by line)												
5: Display tank temp	Display current tank temperature (it is set temperature when enclosed by line)												
6: Outdoor temp	Display outdoor temp												

## First time of power ON (Start of installation)

Initialization	12:00, Mon
Initializing.	

When power is ON, firstly initialization screen appears (10 sec)



17:26, Wed	
[⏻] Start	

When initialization screen ends, it turns to normal screen.



Language	12:00, Wed
ENGLISH	
FRANCAIS	
DEUTSCH	
ITALIANO	
▼ Select	[↵] Confirm

When any button is pressed, language setting screen appears. (CAUTION) If initial setting is not performed, it does not go into menu.



Set language & confirm

Clock format	12:00, Mon
24h	
▼ am/pm	
▼ Select	[↵] Confirm

When language is set, setting screen of time display appears (24h/am/pm)



Set time display & confirm

Date & time	12:00, Mon
Year/Month/Day	Hour : Min
2015 / 01 / 01	12 : 00
↕ Select	[↵] Confirm

YY/MM/DD/Time setup screen appears



Set YY/MM/DD/Time & confirm

17:26, Wed	
[⏻] Start	

Back to initial screen



Press menu, select Installer setup

Main Menu	17:26, Wed
System check	
Personal setup	
Service contact	
Installer setup	
▲ Select	[↵] Confirm



Confirm to go into Installer setup

## 11.3.2 Installer Setup

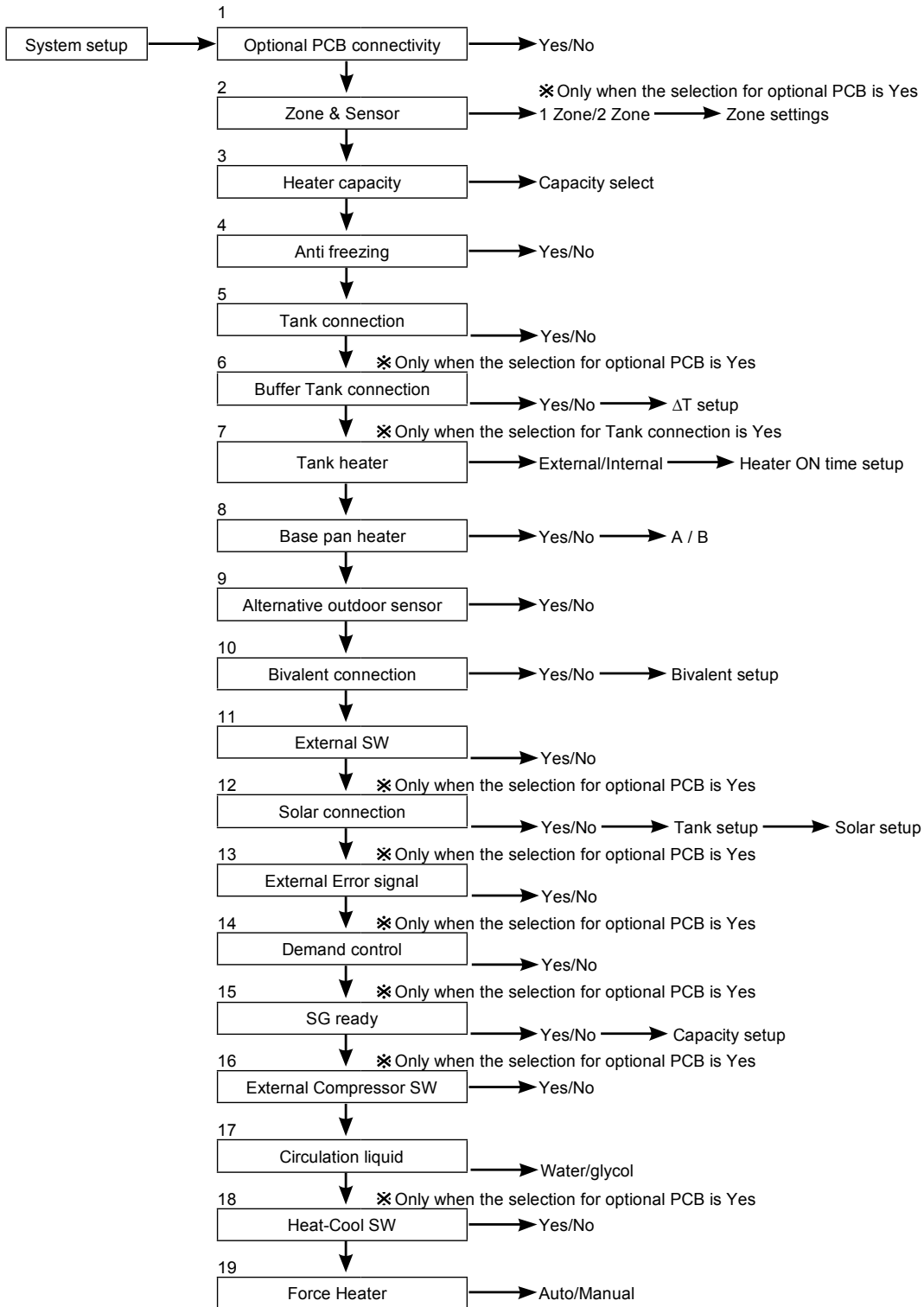



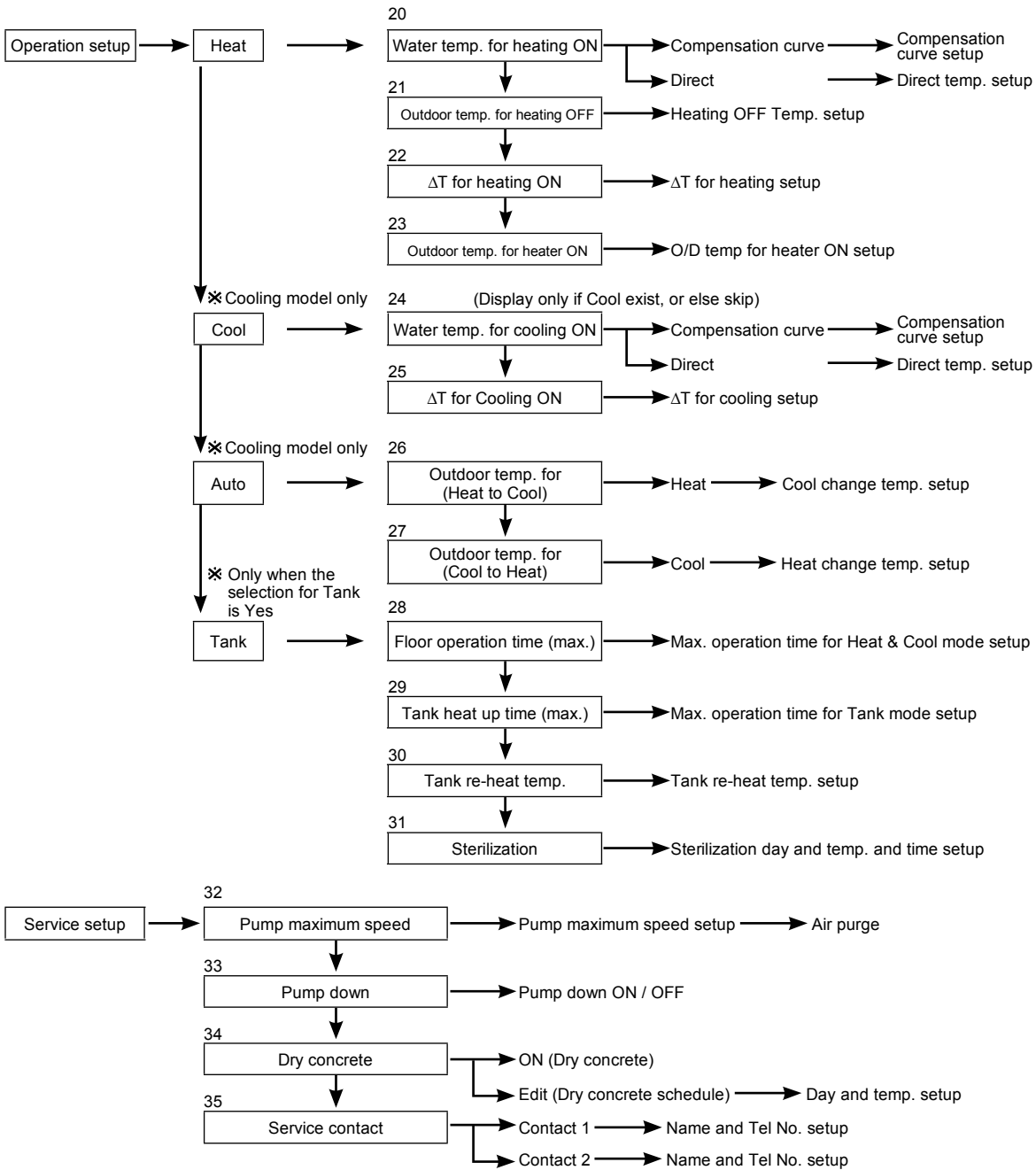

### 11.3.3 System Setup

1. Optional PCB connectivity	Initial setting: No	<table border="1" style="width: 100%; border-collapse: collapse;"> <tr> <td style="text-align: right;">System setup</td> <td style="text-align: right;">17:26, Wed</td> </tr> <tr> <td colspan="2" style="background-color: #f0f0f0;">Optional PCB connectivity</td> </tr> <tr> <td colspan="2">Zone &amp; Sensor</td> </tr> <tr> <td colspan="2">Heater capacity</td> </tr> <tr> <td colspan="2">Anti freezing</td> </tr> <tr> <td style="text-align: right;">▼ Select</td> <td style="text-align: right;">[↵] Confirm</td> </tr> </table>	System setup	17:26, Wed	Optional PCB connectivity		Zone & Sensor		Heater capacity		Anti freezing		▼ Select	[↵] Confirm
System setup	17:26, Wed													
Optional PCB connectivity														
Zone & Sensor														
Heater capacity														
Anti freezing														
▼ Select	[↵] Confirm													

If function below is necessary, please purchase and install optional PCB.  
Please select Yes after installing optional PCB.

- 2-zone control
- Pool
- Buffer tank
- Solar
- External error signal output
- Demand control
- SG ready
- Stop heat source unit by external SW

2. Zone & Sensor	Initial setting: Room and Water temp.	<table border="1" style="width: 100%; border-collapse: collapse;"> <tr> <td style="text-align: right;">System setup</td> <td style="text-align: right;">17:26, Wed</td> </tr> <tr> <td colspan="2" style="background-color: #f0f0f0;">Optional PCB connectivity</td> </tr> <tr> <td colspan="2" style="background-color: #f0f0f0;">Zone &amp; Sensor</td> </tr> <tr> <td colspan="2">Heater capacity</td> </tr> <tr> <td colspan="2">Anti freezing</td> </tr> <tr> <td style="text-align: right;">⬆ Select</td> <td style="text-align: right;">[↵] Confirm</td> </tr> </table>	System setup	17:26, Wed	Optional PCB connectivity		Zone & Sensor		Heater capacity		Anti freezing		⬆ Select	[↵] Confirm
System setup	17:26, Wed													
Optional PCB connectivity														
Zone & Sensor														
Heater capacity														
Anti freezing														
⬆ Select	[↵] Confirm													

If no Optional PCB connectivity  
Select sensor of room temperature control from the following 3 items  
① Water temperature (circulation water temperature)  
② Room thermostat (Internal or External)  
③ Room thermistor

When there is Optional PCB connectivity  
① Select either 1 zone control or 2 zone control.  
If it is 1 zone, select either room or pool, select sensor  
If it is 2 zone, after select sensor of zone 1, select either room or pool for zone 2, select sensor  
(CAUTION) In 2 zone system, pool function can be set at zone 2 only.

3. Heater capacity	Initial setting: Depend on model	<table border="1" style="width: 100%; border-collapse: collapse;"> <tr> <td style="text-align: right;">System setup</td> <td style="text-align: right;">17:26, Wed</td> </tr> <tr> <td colspan="2" style="background-color: #f0f0f0;">Optional PCB connectivity</td> </tr> <tr> <td colspan="2" style="background-color: #f0f0f0;">Zone &amp; Sensor</td> </tr> <tr> <td colspan="2" style="background-color: #f0f0f0;">Heater capacity</td> </tr> <tr> <td colspan="2">Anti freezing</td> </tr> <tr> <td style="text-align: right;">⬆ Select</td> <td style="text-align: right;">[↵] Confirm</td> </tr> </table>	System setup	17:26, Wed	Optional PCB connectivity		Zone & Sensor		Heater capacity		Anti freezing		⬆ Select	[↵] Confirm
System setup	17:26, Wed													
Optional PCB connectivity														
Zone & Sensor														
Heater capacity														
Anti freezing														
⬆ Select	[↵] Confirm													

If there is built-in Heater, set the selectable heater capacity.  
(CAUTION) There are models which cannot select heater.

4. Anti freezing	Initial setting: Yes	<table border="1" style="width: 100%; border-collapse: collapse;"> <tr> <td style="text-align: right;">System setup</td> <td style="text-align: right;">17:26, Wed</td> </tr> <tr> <td colspan="2" style="background-color: #f0f0f0;">Optional PCB connectivity</td> </tr> <tr> <td colspan="2" style="background-color: #f0f0f0;">Zone &amp; Sensor</td> </tr> <tr> <td colspan="2" style="background-color: #f0f0f0;">Heater capacity</td> </tr> <tr> <td colspan="2" style="background-color: #f0f0f0;">Anti freezing</td> </tr> <tr> <td style="text-align: right;">⬆ Select</td> <td style="text-align: right;">[↵] Confirm</td> </tr> </table>	System setup	17:26, Wed	Optional PCB connectivity		Zone & Sensor		Heater capacity		Anti freezing		⬆ Select	[↵] Confirm
System setup	17:26, Wed													
Optional PCB connectivity														
Zone & Sensor														
Heater capacity														
Anti freezing														
⬆ Select	[↵] Confirm													

Operate anti-freezing of water circulation circuit.  
If select Yes, when the water temperature is reaching its freezing temperature, the circulation pump will start up. If the water temperature does not reach the pump stop temperature, back-up heater will be activated.  
(CAUTION) If set No, when the water temperature is reaching its freezing temperature or below 0°C, the water circulation circuit may freeze and cause malfunction.

5. Tank connection	Initial setting: No	<table border="1" style="width: 100%; border-collapse: collapse;"> <tr> <td style="text-align: right;">System setup</td> <td style="text-align: right;">17:26, Wed</td> </tr> <tr> <td colspan="2" style="background-color: #f0f0f0;">Zone &amp; Sensor</td> </tr> <tr> <td colspan="2" style="background-color: #f0f0f0;">Heater capacity</td> </tr> <tr> <td colspan="2" style="background-color: #f0f0f0;">Anti freezing</td> </tr> <tr> <td colspan="2" style="background-color: #f0f0f0;">Tank connection</td> </tr> <tr> <td style="text-align: right;">⬆ Select</td> <td style="text-align: right;">[↵] Confirm</td> </tr> </table>	System setup	17:26, Wed	Zone & Sensor		Heater capacity		Anti freezing		Tank connection		⬆ Select	[↵] Confirm
System setup	17:26, Wed													
Zone & Sensor														
Heater capacity														
Anti freezing														
Tank connection														
⬆ Select	[↵] Confirm													

Select whether it is connected to hot water tank or not.  
If set Yes, it becomes setting that uses hot water function.  
Hot water temperature of tank can be set from main screen.

6. Buffer Tank connection	Initial setting: No	<table border="1" style="width: 100%; border-collapse: collapse;"> <tr> <td style="text-align: right;">System setup</td> <td style="text-align: left;">17:26, Wed</td> </tr> <tr> <td colspan="2">Heater capacity</td> </tr> <tr> <td colspan="2">Anti freezing</td> </tr> <tr> <td colspan="2">Tank connection</td> </tr> <tr style="background-color: #f0f0f0;"> <td colspan="2">Buffer tank connection</td> </tr> <tr> <td style="text-align: right;">↕ Select</td> <td style="text-align: left;">[←] Confirm</td> </tr> </table>	System setup	17:26, Wed	Heater capacity		Anti freezing		Tank connection		Buffer tank connection		↕ Select	[←] Confirm
System setup	17:26, Wed													
Heater capacity														
Anti freezing														
Tank connection														
Buffer tank connection														
↕ Select	[←] Confirm													

Select whether it is connected to buffer tank for heating or not.  
 If buffer tank is used, please set Yes.  
 Connect buffer tank thermistor and set, ΔT (ΔT use to increase primary side temp against secondary side target temp).  
 (CAUTION) Does not display if there is no Optional PCB.  
 If the buffer tank capacity is not so large, please set larger value for ΔT.

7. Tank heater	Initial setting: Internal	<table border="1" style="width: 100%; border-collapse: collapse;"> <tr> <td style="text-align: right;">System setup</td> <td style="text-align: left;">17:26, Wed</td> </tr> <tr> <td colspan="2">Anti freezing</td> </tr> <tr> <td colspan="2">Tank connection</td> </tr> <tr> <td colspan="2">Buffer tank connection</td> </tr> <tr style="background-color: #f0f0f0;"> <td colspan="2">Tank heater</td> </tr> <tr> <td style="text-align: right;">↕ Select</td> <td style="text-align: left;">[←] Confirm</td> </tr> </table>	System setup	17:26, Wed	Anti freezing		Tank connection		Buffer tank connection		Tank heater		↕ Select	[←] Confirm
System setup	17:26, Wed													
Anti freezing														
Tank connection														
Buffer tank connection														
Tank heater														
↕ Select	[←] Confirm													

Select to use either built-in heater or external heater as heater for hot water tank.  
 If heater is installed on tank, please select External.  
 (CAUTION) Does not display if there is no tank for hot water supply.  
 Please set "Tank heater" to "ON" in the "Function setup" from remote controller when using heater to boil the tank.

**External** A setting which is using booster heater installed on DHW tank to boil the tank.  
 The permissible heater capacity is 3kW and below.  
 The operation to boil the tank with heater is as below.  
 In addition, be sure to set suitable "Tank heater: ON time"

**For 65°C setting**

HP  
Booster heater  
Pump

**Internal** A setting which is using backup heater of indoor unit to boil the tank.  
 The operation to boil the tank with heater is as below.

**For 65°C setting**

HP  
Booster heater  
Pump

8. Base pan heater	Initial setting: No	<table border="1" style="width: 100%; border-collapse: collapse;"> <tr> <td style="text-align: right;">System setup</td> <td style="text-align: left;">17:26, Wed</td> </tr> <tr> <td colspan="2">Tank connection</td> </tr> <tr> <td colspan="2">Buffer tank connection</td> </tr> <tr> <td colspan="2">Tank heater</td> </tr> <tr style="background-color: #f0f0f0;"> <td colspan="2">Base pan heater</td> </tr> <tr> <td style="text-align: right;">↕ Select</td> <td style="text-align: left;">[←] Confirm</td> </tr> </table>	System setup	17:26, Wed	Tank connection		Buffer tank connection		Tank heater		Base pan heater		↕ Select	[←] Confirm
System setup	17:26, Wed													
Tank connection														
Buffer tank connection														
Tank heater														
Base pan heater														
↕ Select	[←] Confirm													

Select whether Base pan heater is installed or not.  
 If set Yes, select to use either heater A or B.  
 A: Turn on Heater when heating with defrost operation only  
 B: Turn on Heater at heating

9. Alternative outdoor sensor	Initial setting: No	<table border="1" style="width: 100%; border-collapse: collapse;"> <tr> <td style="text-align: right;">System setup</td> <td style="text-align: left;">17:26, Wed</td> </tr> <tr> <td colspan="2">Buffer tank connection</td> </tr> <tr> <td colspan="2">Tank heater</td> </tr> <tr> <td colspan="2">Base pan heater</td> </tr> <tr style="background-color: #f0f0f0;"> <td colspan="2">Alternative outdoor sensor</td> </tr> <tr> <td style="text-align: right;">↕ Select</td> <td style="text-align: left;">[←] Confirm</td> </tr> </table>	System setup	17:26, Wed	Buffer tank connection		Tank heater		Base pan heater		Alternative outdoor sensor		↕ Select	[←] Confirm
System setup	17:26, Wed													
Buffer tank connection														
Tank heater														
Base pan heater														
Alternative outdoor sensor														
↕ Select	[←] Confirm													

Set Yes if outdoor sensor is installed.  
 Controlled by optional outdoor sensor without reading the outdoor sensor of heat pump unit.

10. Bivalent connection

Initial setting: No

System setup	17:26, Wed
Tank heater	
Base pan heater	
Alternative outdoor sensor	
<b>Bivalent connection</b>	
⬆ Select	[↵] Confirm

Set if heat pump linked with boiler operation.  
 Connect the start signal of the boiler in boiler contact terminal (main PCB).  
 Set Bivalent connection to YES.  
 After that, please begin setting according to remote controller instruction.  
 Boiler icon will be displayed on remote controller top screen.

There are 3 different modes in the boiler operation. Movement of each modes are shown below.  
 ① Alternative (switch to boiler operation when drops below setting temperature)  
 ② Parallel (allow boiler operation when drops below setting temperature)  
 ③ Advanced Parallel (able to slightly delay boiler operation time of parallel operation)

When the boiler operation is "ON", "boiler contact" is "ON", " \_ "(underscore) will be displayed below the boiler icon.  
 Please set target temperature of boiler to be the same as heat pump temperature.  
 When boiler temperature is higher than heat pump temperature, zone temperature cannot be achieved if mixing valve is not installed.  
 This product only allows one signal to control the boiler operation. Operation setting of boiler shall be responsible by installer.

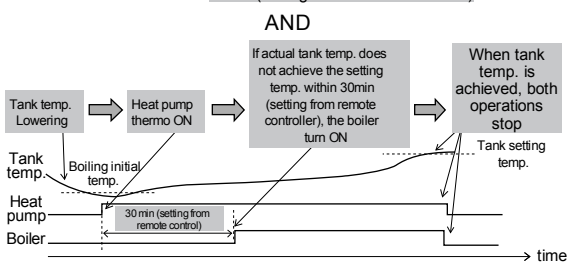
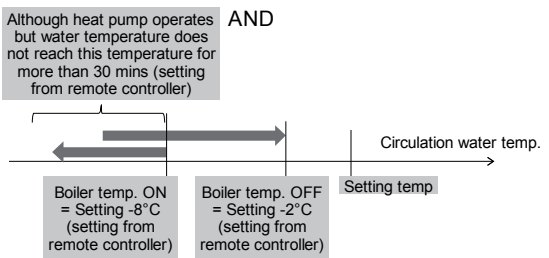
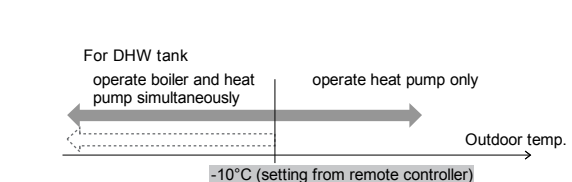
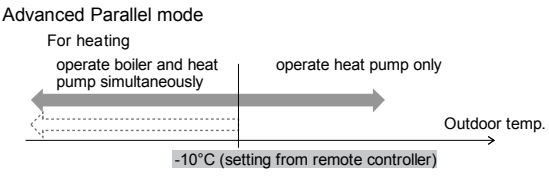
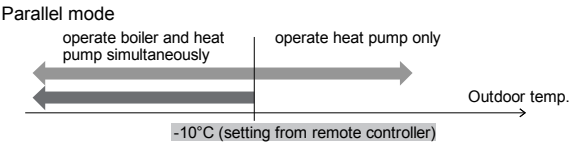
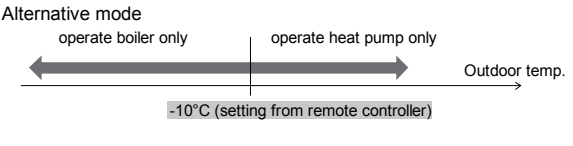

In Advanced Parallel mode, setting for both heating and tank can be made simultaneously. During operation of "Heating/Tank" mode, when each time the mode is switched, the boiler output will be reset to OFF. Please have good understanding on the boiler control characteristic in order to select the optimal setting for the system.

11. External SW

Initial setting: No

System setup	17:26, Wed
Base pan heater	
Alternative outdoor sensor	
Bivalent connection	
<b>External SW</b>	
⬆ Select	[↵] Confirm

Able to turn ON/OFF the operation by external switch.

12. Solar connection

Initial setting: No

System setup	17:26, Wed
Alternative outdoor sensor	
Bivalent connection	
External SW	
<b>Solar connection</b>	
⬆ Select	[↵] Confirm

Set when solar water heater is installed.

- Setting include items below.
- ① Set either buffer tank or DHW tank for connection with solar water heater.
  - ② Set temperature difference between solar panel thermistor and buffer tank or DHW tank thermistor to operate the solar pump.
  - ③ Set temperature difference between solar panel thermistor and buffer tank or DHW tank thermistor to stop the solar pump.
  - ④ Anti-freezing operation start temperature (please change setting based on usage of glycol.)
  - ⑤ Solar pump stop operation when it exceeds high limit temperature (when tank temperature exceed designated temperature (70~90°C))

**13. External Error Signal**      Initial setting: No

Set when external error display unit is installed.  
Turn on Dry Contact SW when error happened.

(CAUTION) Does not display when there is no Optional PCB.  
When error occurs, error signal will be ON.  
After turn off "close" from the display, error signal will still remain ON.

System setup      17:26, Wed

Bivalent connection

External SW

Solar connection

External error signal

⬆ Select      [←] Confirm

**14. Demand control**      Initial setting: No

Set when there is demand control.  
Adjust terminal voltage within 1 ~ 10 V to change the operating current limit.

(CAUTION) Does not display when there is no Optional PCB.

System setup      17:26, Wed

External SW

Solar connection

External error signal

Demand control

⬆ Select      [←] Confirm

Analog input [V]	Rate [%]	
0.0	not activate	
0.1 ~ 0.6	not activate	
0.7	10	not activate
0.8	not activate	
0.9 ~ 1.1	10	
1.2	15	10
1.3	10	
1.4 ~ 1.6	15	
1.7	20	15
1.8	15	
1.9 ~ 2.1	20	
2.2	25	20
2.3	20	
2.4 ~ 2.6	25	
2.7	30	25
2.8	25	
2.9 ~ 3.1	30	
3.2	35	30
3.3	30	
3.4 ~ 3.6	35	
3.7	40	35
3.8	35	

Analog input [V]	Rate [%]	
3.9 ~ 4.1	40	
4.2	45	40
4.3	40	
4.4 ~ 4.6	45	
4.7	50	45
4.8	45	
4.9 ~ 5.1	50	
5.2	55	50
5.3	50	
5.4 ~ 5.6	55	
5.7	60	55
5.8	55	
5.9 ~ 6.1	60	
6.2	65	60
6.3	60	
6.4 ~ 6.6	65	
6.7	70	65
6.8	65	
6.9 ~ 7.1	70	
7.2	75	70
7.3	70	

Analog input [V]	Rate [%]	
7.4 ~ 7.6	75	
7.7	80	75
7.8	75	
7.9 ~ 8.1	80	
8.2	85	80
8.3	80	
8.4 ~ 8.6	85	
8.7	90	85
8.8	85	
8.9 ~ 9.1	90	
9.2	95	90
9.3	90	
9.4 ~ 9.6	95	
9.7	100	95
9.8	95	
9.9 ~	100	

\*A minimum operating current is applied on each model for protection purpose.  
\*0.2 voltage hysteresis is provided.  
\* The value of voltage after 2nd decimal point are cut off.

**15. SG ready**      Initial setting: No

Switch operation of heat pump by open-short of 2 terminals.  
Setting belows are possible

SG signal		Working pattern
Vcc-bit1	Vcc-bit2	
Open	Open	Normal
Short	Open	Heat pump and Heater OFF
Open	Short	Capacity 1
Short	Short	Capacity 2

Capacity setting 1

- Heating capacity \_\_\_%
- DHW capacity \_\_\_%

Capacity setting 2

- Heating capacity \_\_\_%
- DHW capacity \_\_\_%

} Set by SG ready setting of remote controller

System setup      17:26, Wed

Solar connection

External error signal

Demand control

SG ready

⬆ Select      [←] Confirm

**16. External Compressor SW**      Initial setting: No

Set when external compressor SW is connected.  
SW is connected to external devices to control power consumption, ON signal will stop compressor's operation. (Heating operation etc. are not cancelled).

(CAUTION) Does not display if there is no Optional PCB.

If follow Swiss standard power connection, need to turn on DIP SW of main unit PCB. ON/OFF signal used to ON/OFF tank heater (for sterilization purpose)

System setup      17:26, Wed

External error signal

Demand control

SG ready

External compressor SW

⬆ Select      [←] Confirm

17. Circulation Liquid	Initial setting: Water	<div style="float: right; text-align: right;">System setup 17:26, Wed</div> Demand control SG ready External compressor SW <b>Circulation liquid</b> ⬇ Select      [↵] Confirm
------------------------	------------------------	--

Set circulation of heating water.

There are 2 types of settings, water and anti-freeze function.

(CAUTION) Please set glycol when using anti-freeze function. It may cause error if setting is wrong.

18. Heat-Cool SW	Initial setting: Disable	<div style="float: right; text-align: right;">System setup 17:26, Wed</div> SG ready External compressor SW Circulation liquid <b>Heat-Cool SW</b> ▲ Select      [↵] Confirm
------------------	--------------------------	--

Able to switch (fix) heating & cooling by external switch.

(Short) : Fix at Heating (Heating +DHW)  
 (Open) : Fix at Cooling (Cooling +DHW)

(CAUTION) This setting is disabled for model without Cooling.  
 (CAUTION) Does not display if there is no Optional PCB.

Timer function cannot be used. Cannot use Auto mode.

19. Force Heater	Initial setting: Manual	<div style="float: right; text-align: right;">System setup 17:26, Wed</div> External compressor SW Circulation liquid Heat-Cool SW <b>Force heater</b> ▲ Select      [↵] Confirm
------------------	-------------------------	--

Under manual mode, user can turn on force heater through quick menu.

If selection is 'auto', force heater mode will turn automatically if pop up error happen during operation.

Force heater will operate follow the latest mode selection, mode selection is disable under force heater operation.

Heater source will ON during force heater mode

### 11.3.4 Operation Setup

#### Heat

20. Water temp. for heating ON	Initial setting: compensation curve	<div style="float: right; text-align: right;">Decide temperature of 4 points as shown in diagram</div> <p>Hot water temperature 55°C</p> <p>35°C</p> <p>Outdoor temperature -5°C, 15°C</p> <p>compensation curve</p>
--------------------------------	-------------------------------------	--

Set target water temperature to operate heating operation.  
 Compensation curve: Target water temperature change in conjunction with outdoor ambient temperature change.  
 Direct: Set direct circulation water temperature.

In 2 zone system, zone 1 and zone 2 water temperature can be set separately.

21. Outdoor temp. for heating OFF	Initial setting: 24°C	<p>ON</p> <p>24°C</p> <p>OFF</p>
-----------------------------------	-----------------------	----------------------------------

Set outdoor temp to stop heating.  
 Setting range is 5°C ~ 35°C

22. ΔT for heating ON	Initial setting: 5°C	<p>Out →</p> <p>Return ←</p> <p>Out — Return = 1°C ~ 15°C</p>
-----------------------	----------------------	---

Set temp difference between out temp & return temp of circulating water of Heating operation.

When temp gap is enlarged, it is energy saving but less comfort. When the gap gets smaller, energy saving effect gets worse but it is more comfortable.

Setting range is 1°C ~ 15°C

23. Outdoor temp. for heater ON	Initial setting: 0°C	<p>ON</p> <p>0°C</p> <p>OFF</p>
---------------------------------	----------------------	---------------------------------

Set outdoor temp when back-up heater starts to operate.  
 Setting range is -15°C ~ 20°C

User shall set whether to use or not to use heater.

## Cool

24. Water temp. for cooling ON

Initial setting: compensation curve

Set target water temperature to operate cooling operation.  
 Compensation curve: Target water temperature change in conjunction with outdoor ambient temperature change.  
 Direct : Set direct circulation water temperature.

In 2 zone system, zone 1 and zone 2 water temperature can be set separately.

25. ΔT for cooling ON

Initial setting: 5°C

Set temp difference between out temp & return temp of circulating water of Cooling operation.  
 When temp gap is enlarged, it is energy saving but less comfort. When the gap gets smaller, energy saving effect gets worse but it is more comfortable.  
 Setting range is 1°C ~ 15°C

## Auto

26. Outdoor temp. for (Heat to Cool)

Initial setting: 15°C

Set outdoor temp that switches from heating to cooling by Auto setting.  
 Setting range is 5°C ~ 25°C

Timing of judgement is every 1 hour

27. Outdoor temp. for (Cool to Heat)

Initial setting: 10°C

Set outdoor temp that switches from Cooling to Heating by Auto setting.  
 Setting range is 5°C ~ 25°C

Timing of judgement is every 1 hour

## Tank

28. Floor operation time (max)

Initial setting: 8h

Set max operating hours of heating.  
 When max operation time is shortened, it can boil the tank more frequently.

It is a function for Heating + Tank operation.

29. Tank heat up time (max)

Initial setting: 60min

Set max boiling hours of tank.  
 When max boiling hours are shortened, it immediately returns to Heating operation, but it may not fully boil the tank.

**30. Tank re-heat temp.** Initial setting: -8°C

Set temp to perform reboil of tank water.  
(When boiled by heat pump only, (51°C – Tank re-heat temp) shall become max temp.)

Setting range is -12°C ~ -2°C

**31. Sterilization** Initial setting: 65°C 10min

Set timer to perform sterilization.

- 1 Set operating day & time. (Weekly timer format)
- 2 Sterilization temp (55~75°C ✕ If use back-up heater, it is 65°C)
- 3 Operation time (Time to run sterilization when it reached setting temp 5min ~ 60min)

User shall set whether to use or not to use sterilization mode.

### 11.3.5 Service Setup

**32. Pump maximum speed** Initial setting: Depend on model

Normally setting is not necessary.  
Please adjust when need to reduce the pump sound etc.  
Besides that, it has Air Purge function.

Service setup	17:26, Wed	
Flow rate	Max. Duty	Operation
88:8 L/min	0xCE	<b>Air Purge</b>
◀ Select		

**33. Pump down**

Operate pump down operation

Service setup	17:26, Wed
Pump down:	ON
[↵] Confirm	

**34. Dry concrete**

Operate concrete curing operation.  
Select Edit, set temp for every stage (1~99 1 is for 1 day).  
Setting range is 25~55°C

When it is turned ON, dry concrete starts.

When it is 2 zone, it dries both zones.

**35. Service contact**

Able to set name & tel no. of contact person when there is breakdown etc. or client has trouble. (2 items)

Service setup	17:26, Wed
Service contact:	Contact 1
Contact 2	
▲ Select	[↵] Confirm

Contact-1: Bryan Adams	
ABC/ abc	0-9/ Other
A B C D E F G H I J K L M N O P Q R	
S T U V W X Y Z a b c d e f g h i	
j k l m n o p q r s t u v w x y z	
▼ Select	[↵] Enter



## 11.4 Service and maintenance

### When connect CN-CNT connector with computer

Please use optional USB cable to connect with CN-CNT connector.  
After connected, it requests for driver. If PC is under Windows Vista or later version, it automatically installs the driver under internet environment.

If PC uses Windows XP or earlier version and there is no internet access, please get FTDI Ltd's USB - RS232C conversion IC driver (VCP driver) and install.  
<http://www.ftdichip.com/Drivers/VCP.htm>

### If forget Password and cannot operate remote controller

Press + + for 5 sec.  
Password unlock screen appears, press Confirm and it shall reset.  
Password will become 0000. Please reset it again.  
(CAUTION) Only display when it is locked by password.

### 11.4.1 Maintenance menu

#### Setting method of Maintenance menu

Maintenance menu	17:26, Wed
<b>Actuator check</b>	
Test mode	
Sensor setup	
Reset password	
▼ Select	[←] Confirm

Press + + for 5 sec.

Items that can be set

- ① Actuator check (Manual ON/OFF all functional parts)  
(CAUTION) As there is no protection action, please be careful not to cause any error when operating each part (do not turn on pump when there is no water etc.)
- ② Test mode (Test run)  
Normally it is not used.
- ③ Sensor setup (offset gap of detected temp of each sensor within -2~2°C range)  
(CAUTION) Please use only when sensor is deviated.  
It affects temperature control.
- ④ Reset password (Reset password)

### 11.4.2 Custom menu

#### Setting method of Custom menu

Custom menu	17:26, Wed
<b>Cool mode</b>	
Back-up heater	
Reset energy monitor	
▼ Select	[←] Confirm

Please press + + for 10 sec.

Items that can be set

- ① Cool mode (Set With/Without Cooling function) Default is without  
(CAUTION) As with/without Cool mode may affect electricity application, please be careful and do not simply change it.  
In Cool mode, please be careful if piping is not insulated properly, dew may form on pipe and water may drip on the floor and damage the floor.
- ② Back-up heater (Use/Do not use Backup heater)  
(CAUTION) It is different from to use/not to use backup heater set by client. When this setting is used, heater power on due to protection against frost will be disabled. (Please use this setting when it is required by utility company.)  
By using this setting, it cannot defrost due to low Heating's setting temp and operation may stop (H75)  
Please set under the responsibility of installer. When it stops frequently, it may be due to insufficient circulation flow rate, setting temp of heating is too low etc.
- ③ Reset energy monitor (delete memory of Energy monitor)  
Please use when moving house and handover the unit.

## 11.5 Outdoor Unit

### 11.5.1 Select the Best Location

- If an awning is built over the unit to prevent direct sunlight or rain, be careful that heat radiation from the condenser is not obstructed.
- Avoid installations in areas where the ambient temperature may drop below -20°C for UD models and -28°C for UX models.
- Keep the spaces indicated by arrows from wall, ceiling, fence or other obstacles.
- Do not place any obstacles which may cause a short circuit of the discharged air.
- If outdoor unit installed near sea, region with high content of sulphur or oily location (e.g. machinery oil, etc), its lifespan may be shortened.
- When installing the product in a place where it will be affected by typhoon or strong wind such as wind blowing between buildings, including the rooftop of a building and a place where there is no building in surroundings, fix the product with an overturn prevention wire, etc. (Overturn prevention fitting model number: K-KYZP15C)

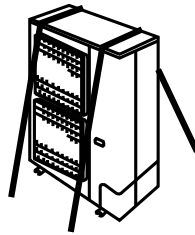

- If piping length is over 10 m, additional refrigerant should be added as shown in the table.

Model	Piping size		Rated Length (m)		Max. Elevation (m)	Min. Piping Length (m)	Max. Piping Length (m)	Additional Refrigerant (g/m)
	Gas	Liquid	For Heat Pump Indoor Unit	For Hydromodule + Tank				
UX09*E5*, UX12*E5*, UD12*E5*, UD16*E5*, UX09*E8*, UX12*E8*, UX16*E8*, UD09*E8*, UD12*E8*, UD16*E8*	ø15.88 mm (5/8")	ø9.52 mm (3/8")	7	5	20	3	30	50

Example:

If piping length is 30 m, the quantity of additional refrigerant should be 1000g. [(30-10)m × 50 g/m = 1000g]  
GWP (R410A) = 2088

## 11.5.2 Install The Outdoor Unit

### 11.5.2.1 Installation Diagram

- It is advisable to avoid more than 2 blockage directions. For better ventilation & multiple-outdoor installation, please consult authorized dealer/specialist.
- This illustration is for explanation purposes only.

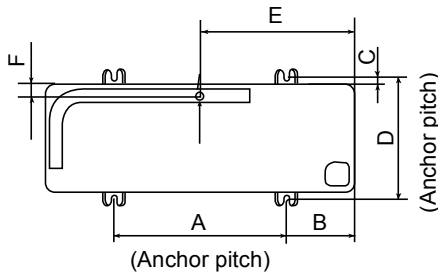
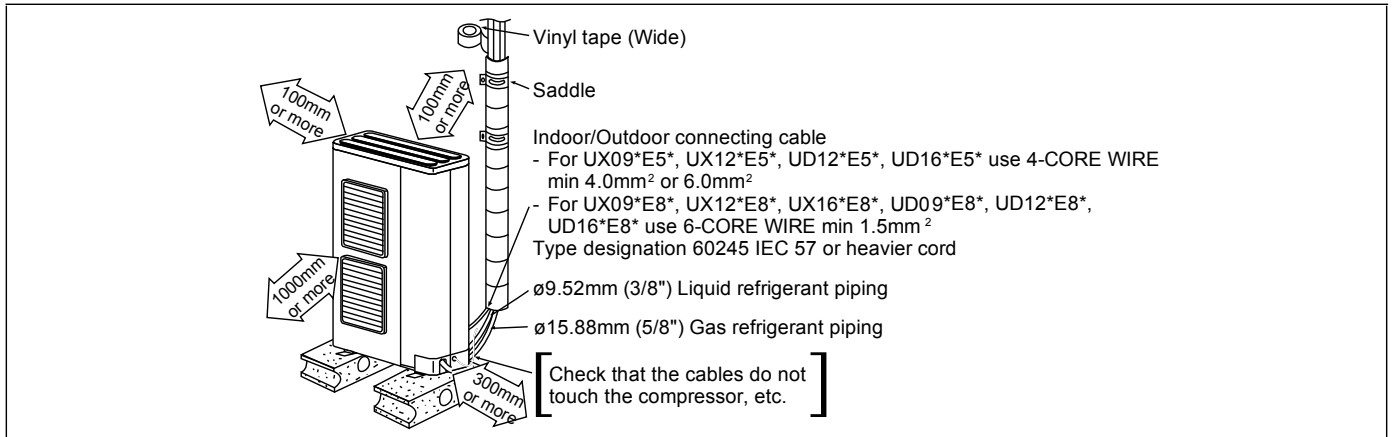

Model	A	B	C	D	E	F
UX09*E5*, UX12*E5*, UD12*E5*, UD16*E5*, UX09*E8*, UX12*E8*, UX16*E8*, UD09*E8*, UD12*E8*, UD16*E8*	620	140	15	355	450	44

(Unit : mm)

- After selecting the best location, start installation according to Installation Diagram.
  - Fix the unit on concrete or rigid frame firmly and horizontally by bolt nut ( $\phi 10$  mm).
  - When installing at roof, please consider strong wind and earthquake. Please fasten the installation stand firmly with bolt or nails.

### 11.5.2.2 Disposal of Outdoor Unit Drain Water

- When a Drain elbow **1** is used, please ensure to follow below:
  - the unit should be placed on a stand which is taller than 50 mm.
  - cover the  $\phi 20$  mm holes with Rubber cap **2** (refer to illustration below).
  - use a tray (field supply) when necessary to dispose the outdoor unit drain water.
- If the unit is used in an area where temperature falls below  $0^{\circ}\text{C}$  for 2 or 3 consecutive days, it is recommended not to use the Drain elbow **1** and Rubber cap **2**, for the drain water freezes and the fan will not rotate.

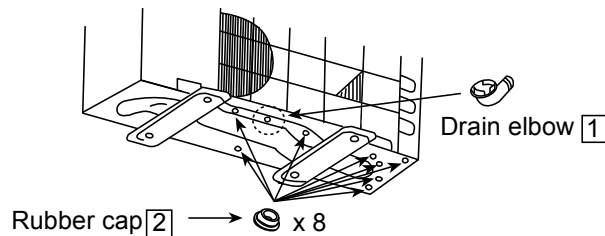

### 11.5.3 Connecting The Piping

 <b>CAUTION</b>
Do not over tighten, over tightening cause gas leakage.

Model	Piping size (Torque)	
	Gas	Liquid
UX09*E5*, UX12*E5*, UD12*E5*, UD16*E5*, UX09*E8*, UX12*E8*, UX16*E8*, UD09*E8*, UD12*E8*, UD16*E8*	ø15.88 mm (5/8") [65 N•m]	ø9.52 mm (3/8") [42 N•m]

#### 11.5.3.1 Connecting the Piping to Outdoor Unit

Decide piping length and then cut by using pipe cutter. Remove burrs from cut edge. Make flare after inserting the flare nut (locate at valve) onto the copper pipe. Align center of piping to valves and then tighten with torque wrench to the specified torque as stated in the table.

Local pipes can project in any of four directions.

- Make holes in the pipe panels for the pipes to pass through.
- Be sure to install the pipe panels to prevent rain from getting inside the outdoor unit.  
[Removing the service panel].
  1. Remove the three mounting screws.
  2. Slide the service panel downward to release the pawls.

After this, pull the service panel toward you to remove it.

#### CUTTING AND FLARING THE PIPING

1. Please cut using pipe cutter and then remove the burrs.
2. Remove the burrs by using reamer. If burrs is not removed, gas leakage may be caused.  
Turn the piping end down to avoid the metal powder entering the pipe.
3. Please make flare after inserting the flare nut onto the copper pipes.

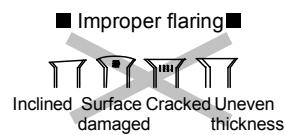
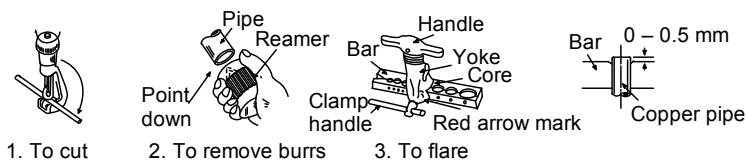

When properly flared, the internal surface of the flare will evenly shine and be of even thickness. Since the flare part comes into contact with the connections, carefully check the flare finish.

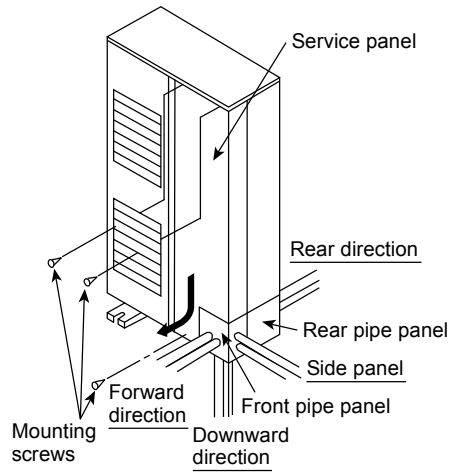

Close the tube joining area with putty heat insulator (local supply) without any gap as shown in right figure. (To prevent insects or small animal entering.)

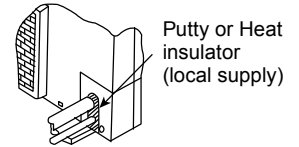

## 11.5.4 Evacuation Of The Equipment

WHEN INSTALLING AN AIR-TO-WATER HEAT PUMP, BE SURE TO EVACUATE THE AIR INSIDE THE UNIT AND PIPES in the following procedure.

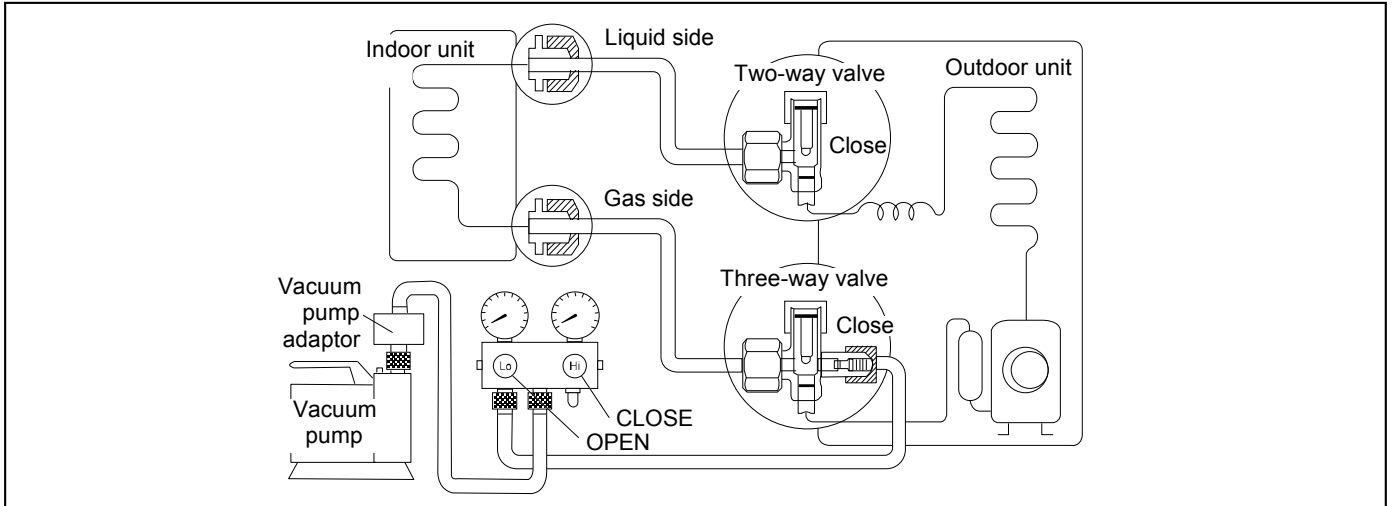

- 1 Connect a charging hose with a push pin to the Low side of a charging set and the service port of the 3-way valve.
  - Be sure to connect the end of the charging hose with the push pin to the service port.
- 2 Connect the center hose of the charging set to a vacuum pump with check valve, or vacuum pump and vacuum pump adaptor.
- 3 Turn on the power switch of the vacuum pump and make sure that the needle in the gauge moves from 0 cmHg (0 MPa) to -76 cmHg (-0.1 MPa). Then evacuate the air approximately ten minutes.
- 4 Close the Low side valve of the charging set and turn off the vacuum pump. Make sure that the needle in the gauge does not move after approximately five minutes.  
Note: BE SURE TO FOLLOW THIS PROCEDURE IN ORDER TO AVOID REFRIGERANT GAS LEAKAGE.
- 5 Disconnect the charging hose from the vacuum pump and from the service port of the 3-way valve.
- 6 Tighten the service port caps of the 3-way valve at a torque of 18 N•m with a torque wrench.
- 7 Remove the valve caps of both of the 2-way valve and 3-way valve. Position both of the valves to "OPEN" using a hexagonal wrench (4 mm).
- 8 Mount valve caps onto the 2-way valve and the 3-way valve.
  - Be sure to check for gas leakage.

### ⚠ CAUTION

If gauge needle does not move from 0 cmHg (0 MPa) to -76 cmHg (-0.1 MPa), in step ③ above take the following measure:

- If the leak stops when the piping connections are tightened further, continue working from step ③.
- If the leak does not stop when the connections are retightened, repair the location of leak.
- Do not release refrigerant during piping work for installation and reinstallation. Take care of the liquid refrigerant, it may cause frostbite.

### 11.5.4.1 Air-Tightness Test on the Refrigerating System

Before system charged with refrigerant and before the refrigerating system in put into operation, below site test procedure and acceptance criteria shall be verified by the certified technicians, and/or the installer:-

Step 1: Pressure test for refrigerant leak detection:

1. Steps for pressure test, in accordance to ISO 5149.
2. Evacuate the system from refrigerant before the leak test, attach the gauge manifold set correctly and tightly. Charging hose of Low side connect to Gas side. (Charging hose of High side connect to Liquid side if applicable.)
3. Adjust the knob on the service valves, and regulator on the gauge set, so that test gas can be inserted through the centre manifold of the gauge set.
4. Insert Nitrogen gas into the system through the centre manifold and wait until the pressure within the system to reach about 1MPa (10 BarG) wait for a few hours and monitor the pressure reading on the gauges.
5. Please note that the system's pressure may rise slightly if the test is carried out on mid day, due to temperature rise. The inverse may happen when there is temperature drop at night. However, this variation will be minimal.
6. Waiting time depends on the size of the system. Larger systems may require 12 hours of waiting time. Leak detection within smaller system can be achieved in 4 hours.
7. Check if there is a constant pressure drop. Move to next step "Step 2: Refrigerant leak detection..." if there is any pressure drop. Otherwise, release the Nitrogen gas and, move to "Step 3: Vacuum test".

8. Next, insert a small amount of same refrigerant into the system through the centre hose, until the pressure reaches about 1MPa (10 BarG).

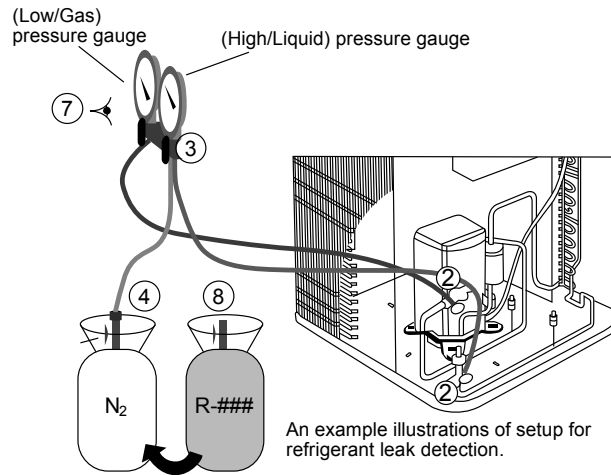

**Step 2: Refrigerant leak detection through Electronic halogen leak detector and/or ultrasonic leak detector:**

1. Use any one of below detector to check leaking.

- Electronic halogen leak detector.
  - Switch on the unit.
  - Cover the test area from direct draft.
  - Pass the detection probe near test area and wait for audible and visible signals.
- Ultrasonic Leak Detector
  - Make sure the area is quiet.
  - Switch on the ultrasonic leak detector.
  - Move the probe along your air conditioning system to test for leaks, and mark for repair.

2. Any leak detected at this level shall be repaired and retested, starting from “Step 1: Pressure test”.

**NOTE:**

- Always recover the refrigerant and Nitrogen gas into recovery cylinder after completion of a test.
- You must use the detection equipment with Detectable Leak Rate of  $10^{-6}$  Pa.m<sub>3</sub>/s or better.
- Do not use refrigerant as test medium for system with total refrigerant charge more than 5kg.
- Test shall be performed with dry Nitrogen or another non-flammable, non-reactive, dried gas. Oxygen, air or mixtures containing them shall not be used.

**Step 3: Vacuum test:**

1. Perform Vacuum test to check leak / moisture if present.
2. Refer to section “EVACUATION OF THE EQUIPMENT” to vacuum gas out of the air conditioning system.
3. Wait for a few hours, depending on the size of the refrigerating system and monitor the pressure rise.
  - If the pressure rises until 1 bar absolute, then there is leak.
  - If the pressure rises, but it is lower than 1 bar absolute, then moisture is present.

Next, remove the moisture, or repair, and redo the refrigerant leak testing, starting from “Step 1: Pressure test”.

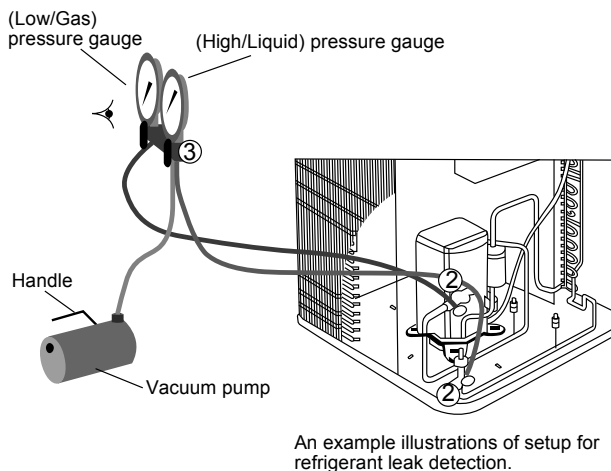

## 11.5.5 Connect The Cable To The Outdoor Unit

(FOR DETAIL REFER TO WIRING DIAGRAM AT UNIT)

1. Remove the control board cover from the unit by loosening the screw.
2. Connecting cable between indoor unit and outdoor unit shall be approved polychloroprene sheathed flexible cable (see below table), type designation 60245 IEC 57 or heavier cable.
3. Secure the cable onto the control board with the holder (clammer).
4. Attach the control board cover back to the original position with screw.

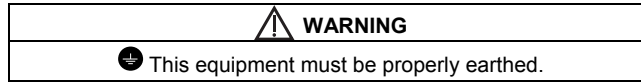

Models	Flexible cable specification
UX09*E5*, UX12*E5*, UD12*E5*, UD16*E5*	4 × min 4.0 mm <sup>2</sup> or 6.0 mm <sup>2</sup>

Terminals on the indoor unit	1	2	3	
Colour of wires				
Terminals on the outdoor unit	1	2	3	

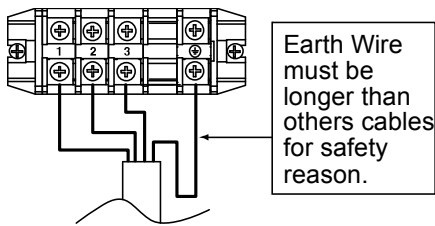

Models	Flexible cable specification
UX09*E8*, UX12*E8*, UX16*E8*, UD09*E8*, UD12*E8*, UD16*E8*	6 × min 1.5 mm <sup>2</sup>

Terminals on the indoor unit	1	2	3	4	5	
Colour of wires						
Terminals on the outdoor unit	1	2	3	4	5	

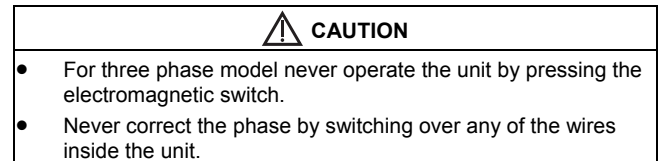
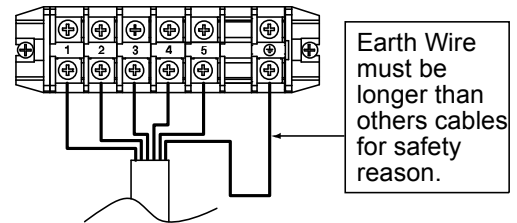

- Select required direction and apply protective bushing provided in accessories to protect cables from sharp edges.
- Once all wiring work has been completed, tie the cable and cord together with the binding strap so that they do not touch other parts such as the compressor and bare copper pipes.

### Outdoor Unit

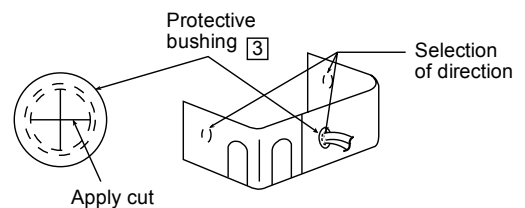
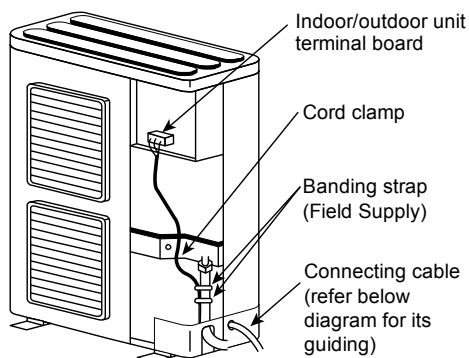

### DETAIL OF CONNECTING CABLE GUIDING

## WIRE STRIPPING AND CONNECTING REQUIREMENT

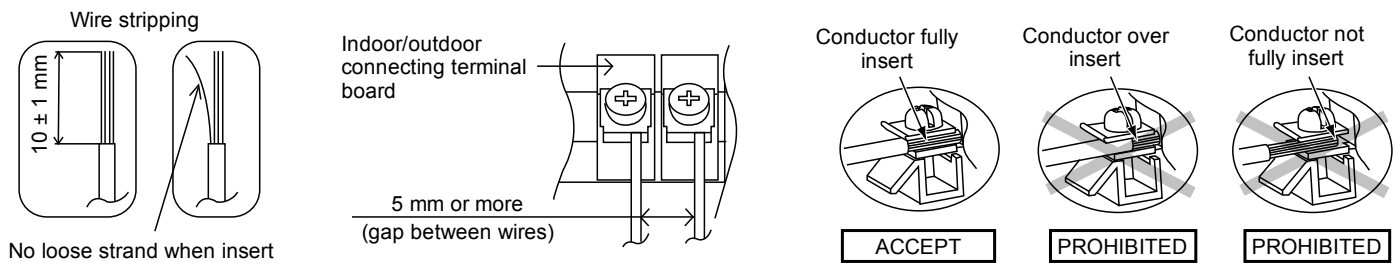

### 11.5.6 Pipe Insulation

1. Please carry out insulation at pipe connection portion as mentioned in Indoor/Outdoor Unit Installation Diagram. Please wrap the insulated piping end to prevent water from going inside the piping.
2. If drain hose or connecting piping is in the room (where dew may form), please increase the insulation by using POLY-E FOAM with thickness 6 mm or above.



## 12. Operation and Control

### 12.1 Basic Function

Inverter control, which equipped with a microcomputer in determining the most suitable operating mode as time passes, automatically adjusts output power for maximum comfort always. In order to achieve the suitable operating mode, the microcomputer maintains the set temperature by measuring the temperature of the environment and performing temperature shifting. The compressor at outdoor unit is operating following the frequency instructed by the microcomputer at indoor unit that judging the condition according to internal water setting temperature and water outlet temperature.

#### 12.1.1 Internal Water Setting Temperature

Once the operation starts, control panel setting temperature will be taken as base value for temperature shifting processes. These shifting processes are depending on the Air-to-Water Heat pump settings and the operation environment. The final shifted value will be used as internal water setting temperature and it is updated continuously whenever the electrical power is supplied to the unit.

#### 12.1.2 Heating Operation

##### 12.1.2.1 Thermostat Control

- Compressor is OFF when Water Outlet Temperature – Internal Water Setting Temperature > 2°C for continuously 3 minutes.
- Compressor is ON after waiting for 3 minutes, if the Water Outlet Temperature – Water Inlet Temperature (temperature at thermostat OFF is triggered) < -3°C.

##### 12.1.2.2 Thermostat Control (Outdoor Ambient Temperature)

Stops provide heating to room side during high outdoor ambient condition.

Control content:

- Heating operation and water pump will turn OFF when outdoor ambient temperature > outdoor thermo off temperature + 3°C.  
(Outdoor thermo off set temperature is set by control panel. Thermo off set temperature is between 5°C ~ 35°C)
- Heating operation will resume when Outdoor ambient temperature < Outdoor thermo OFF set temperature + 1°C.

##### 12.1.2.3 Heat Mode Operation

Operation of heat pump provide heating capacity to room side by hot water through heating panel, floor heating or fan coil unit.

- 1 3 ways valve control:
  - 3 ways valve switch and fix to room side.
- 2 Heat pump operates follow normal heating operation.
- 3 Room heater operate follow normal operation.
- 4 2 ways valve control:
  - 2 ways valve opens.

### 12.1.3 Cooling Operation

#### 12.1.3.1 Thermostat control

- Compressor is OFF when Water Outlet Temperature – Internal Water Setting Temperature > -1.5°C for continuously 3 minutes.
- Compressor is ON after waiting for 3 minutes, if the Water Outlet Temperature – Water Inlet Temperature (temperature at thermostat OFF is triggered) >3°C.

#### 12.1.3.2 Cool Mode Operation

- 1 3 ways valve control:
  - 3 ways valve switch and fix to cooling side.
- 2 Heat pump operates follow normal cooling operation.
- 3 Room heater DOES NOT operate during cool mode.
- 4 2 ways valve control:
  - 2 ways valve is closed.

### 12.1.4 Target Water Temperature Setting

#### 12.1.4.1 Target Water Temperature Control of Standard System (Optional PCB not connected)

There are 2 types of temperature control selection which are Compensation and Direct.

- Temperature control type selection by installer:
  - 1) Compensation : WLo, WHi, ODL0, ODHi can be set at installer menu.
  - 2) Direct : Direct Water Temperature Set
- Remote control setting by user:
  - 1) Compensation : Shift value  $\pm 5^{\circ}\text{C}$  from the compensation curve
  - 2) Direct : Direct water temperature set change

\*This setting at is only able to set when the room sensor select as Water Temperature.

\*Instead of water temperature, user will set target room temperature when room sensor select as Room Thermistor or Internal Room Thermostat.

- Target water temperature is calculated as below condition.
  - Target water temperature = A (Base temperature) + B (shift temperature)

A (Base Temperature)	Compensation	Direct
	Value from the curve + User shift value set	Direct value from user setting

- B (shift temperature) value is depend on the room sensor selection at remote controller as below table:

B (Shift Temp.)	B shift value is depend on the room sensor selection at remocon as table below
Sensor Selection	
Water temperature	B = 0
External Room Thermostat	B = 0
Internal Room Thermostat & Room Thermistor	<b>Cool Mode:</b> B = 0 ; when Zone OFF or Zone Room Thermo OFF B = 1 * (room set temp. (R/C) – actual room temp.) Max/Min Regulation of B: (Max: 5°C ; Min: -5°C)
	<b>Heat Mode:</b> B = 0 ; when Zone OFF or Zone Room Thermo OFF B = follow Heating PI control contents

- Maximum/minimum regulation of Target Water Temperature.

	Heating	Cooling
Max	55°C (Below Ambient -15°C) * 60°C (Below Ambient -10°C) *	20°C
Min	20°C	5°C

\* Between outdoor ambient -10°C and -15°C, max target decreases gradually from 60°C to 55°C.

Compensation Type: (Operation under Heat Mode and Cool Mode)

- The set temperature defines the parameters for the ambient (Outdoor temperature) dependent operation of the unit. The water temperature is determined automatically depending on the outdoor temperature. Default setting is the colder outdoor temperature will result in warmer water and vice versa. The user has the possibility to shift up and shift down the target water by remote control setting.

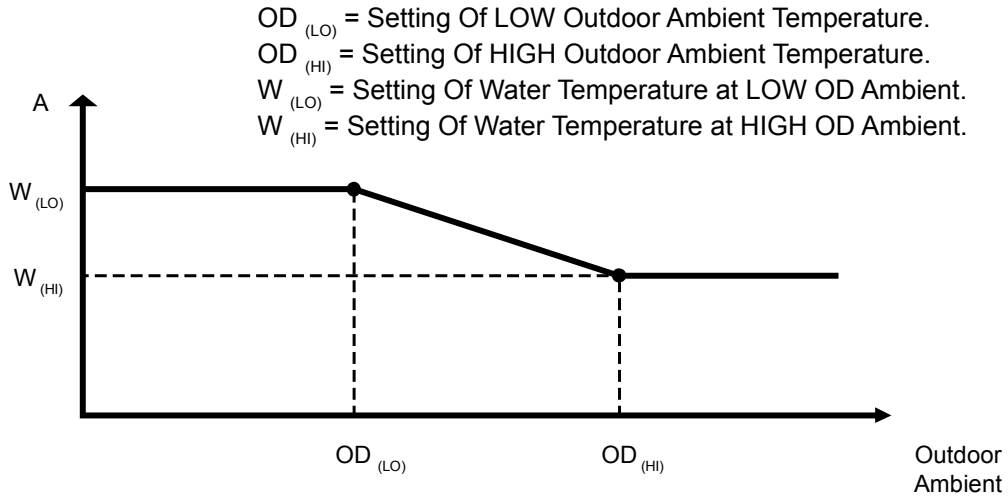

- Outdoor ambient is updated every 30 minutes when operation ON.
- Setting water outlet temperature always follow  $W_{(LO)}$  or  $W_{(HI)}$  whenever is higher if outdoor ambient sensor or indoor communication error happen.

However, when powerful mode is requested by remote control during heating mode, the higher value of HLo or Whi will be used for A calculation.

\*There are 2 compensation curves (for heating and cooling). During heating mode, the heating curve is used and during cooling mode, the cooling curve is use.

- Compensation curve set shift value:

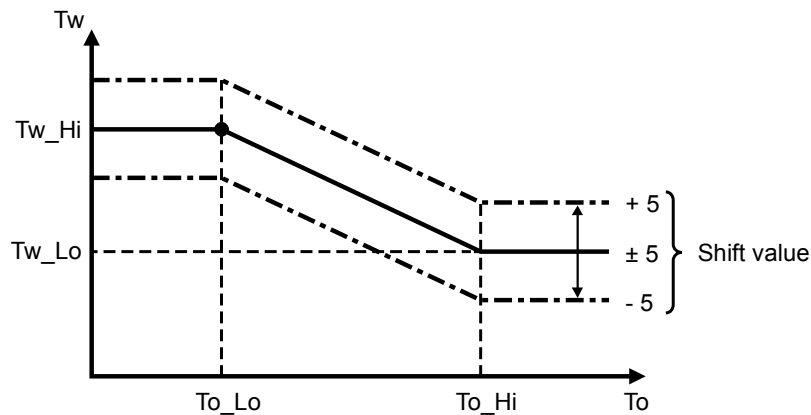

### 12.1.5 Target Water Temperature at Extension System (Optional PCB is connected)

Target water temperature is calculated as below.

- Heat Mode:
  - When buffer tank selection is "YES:"  
Target water temperature = Target buffer tank temperature + [2°C]
  - When buffer tank selection is "NO"
    - If both zone 1 and zone 2 is active  
Target Water Temperature = Higher zone target water temperature of Zone 1 and Zone 2.
    - If only one zone is active  
Target Water Temperature = Zone target water temperature of active zone.
- Cool mode:
  - When buffer tank selection is "YES"
    - If both zone 1 and zone 2 is active  
Target Water Temperature = Lower Zone Target Water Temperature of Zone 1 and Zone 2 + [-3°C]
    - If only one zone is active  
Target Water Temperature = Zone Target Water Temperature of active zone + [-3°C]
  - When buffer tank selection is "NO"
    - If both zone 1 and zone 2 active  
Target Water Temperature = Lower Zone Target Water Temperature of Zone 1 and Zone 2
    - If only one zone is active  
Target Water Temperature = Zone Target Water Temperature of active zone

\*Cool Mode does not have SG ready control

### 12.1.6 Target Zone Water Temperature Control

Purpose:- To control zone mixing and zone pump according to the zone sensor temperature

#### 12.1.6.1 Target Zone 1 water temperature setting control

- Start condition
  - Heating zone 1 is ON by remote control or Timer or Auto Mode **OR**
  - Cooling zone 1 is ON by remote control or Timer or Auto Mode.
  
- Cancel condition
  - Heating zone 1 is OFF by remote control or Timer or Auto mode **AND**
  - Cooling zone 1 is OFF by remote control or Timer or Auto mode.
  
- Target Zone 1 water temperature is calculated as below condition.
  - Target Zone 1 water temperature = A (Base temperature) + B (shift temperature)

A (Base Temperature)	Compensation	Direct
	Value from the curve + User shift value set	Direct value from user setting

\* During heat mode and compensation select, if powerful mode is activated, higher value of WLo or WHi will be use as curve value.

- B (shift temperature) value is depend on the room sensor selection at remote controller as below table:

B (Shift Temp.)	B shift value is depend on the room sensor selection at remocon as table below
Sensor Selection	
Water temperature	B = 0
External Room Thermostat	B = 0
Internal Room Thermostat & Room Thermistor	<b>Cool Mode:</b> B = 0 ; when Zone OFF or Zone Room Thermo OFF B = 1 * (room set temp. (R/C) – actual room temp.) Max/Min Regulation of B: (Max: 5°C ; Min: -5°C)
	<b>Heat Mode:</b> B = 0 ; when Zone OFF or Zone Room Thermo OFF B = follow Heating PI control contents
Pool Function Selected	B = Delta value setting from remocon

\*B = 0 regardless of which sensor selection, if SHP control bit is enable except Pool function select (maintain Pool “B” value)

\*\* Pool function also can be select at Zone 1 when optional PCB is connected and Zone 1 system is select.

- Maximum/minimum regulation of Target Water Temperature.

	Heating	Cooling
Max	55°C (Below Ambient -15°C) * 60°C (Below Ambient -10°C) *	20°C
Min	20°C	5°C

\* Between outdoor ambient -10°C and -15°C, max target decreases gradually from 60°C to 55°C.

- Target Zone 1 Water Temperature (Heat mode only) during SG ready control
  - If buffer tank selection is “NO” then following shift is carried out.
    - o While digital input is “10” or “11” then,  
Final Target Zone 1 water temperature  
= Target Zone 1 water temperature\* (SG ready % setting (remote control menu))%
  - If buffer tank selection is “YES”
    - o No shift of Target Zone 1 Water Temperature. Target Buffer Tank Temperature will change accordingly.  
\* Refer to “Buffer tank temperature control”

### 12.1.6.2 Target Zone 2 water temperature setting control

- Start condition
  - Heating zone 2 is ON by remote control or Timer or Auto Mode **OR**
  - Cooling zone 2 is ON by remote control or Timer or Auto Mode.
- Cancel condition
  - Heating zone 2 is OFF by remote control or Timer or Auto mode **AND**
  - Cooling zone 2 is OFF by remote control or Timer or Auto mode.
- Target Zone 2 water temperature is calculated as below condition.
  - Target Zone 2 water temperature = A (Base temperature) + B (shift temperature)

A (Base Temperature)	Compensation	Direct
	Value from the curve + User shift value set	Direct value from user setting

\* During heat mode and compensation select, if powerful mode is activated, higher value of WLo or WHi will be use as curve value.

- B (shift temperature) value is depend on the room sensor selection at remote controller as below table:

B (Shift Temp.)	B shift value is depend on the room sensor selection at remocon as table below
Sensor Selection	
Water temperature	B = 0
External Room Thermostat	B = 0
Internal Room Thermostat & Room Thermistor	<b>Cool Mode:</b> B = 0 ; when Zone OFF or Zone Room Thermo OFF B = 1 * (room set temp. (R/C) – actual room temp.) Max/Min Regulation of B: (Max: 5°C ; Min: -5°C)
	<b>Heat Mode:</b> B = 0 ; when Zone OFF or Zone Room Thermo OFF B = follow Heating PI control contents
Pool Function Selected	B = Delta value setting from remocon

\*B = 0 regardless of which sensor selection, if SHP control bit is enable except Pool function select (maintain Pool "B" value)

\*\* Pool function also can be select at Zone 2 when optional PCB is connected and Zone 2 system is select.

- Maximum/minimum regulation of Target Water Temperature.

	Heating	Cooling
Max	55°C (Below Ambient -15°C) * 60°C (Below Ambient -10°C) *	20°C
Min	20°C	5°C

\* Between outdoor ambient -10°C and -15°C, max target decreases gradually from 60°C to 55°C.

- Target Zone 2 Water Temperature (Heat mode only) during SG ready control
  - If buffer tank selection is "NO" then following shift is carried out.
    - While digital input is "10" or "11" then,  
Final Target Zone 2 water temperature  
= Target Zone 1 water temperature\* (SG ready % setting (remote control menu))%
  - If buffer tank selection is "YES"
    - No shift of Target Zone 2 Water Temperature. Target Buffer Tank Temperature will change accordingly.  
\* Refer to "Buffer tank temperature control"

### 12.1.6.3 Zone Temperature Control Contents

- During Standard System (Optional PCB not connected)
  - a) Only 1 zone temperature control is available
  - b) This zone room temperature is control by either one of the 4 room sensor (Room Th, Int/Ext Room Thermostat, Water temperature)
  - c) Target Zone Water Temperature is calculated based on selected temperature control type (Compensation or Direct) and selected room sensor. Target Water Temperature will set same as Target Zone Water Temperature
  - d) Target Water Temperature is the temperature for heat pump to operate refer to indoor water outlet sensor.
  - e) Heat pump and water pump OFF when ROOM Thermo OFF (Zone thermo OFF by Room Th or Room Thermostat).

\* There will be no zone sensor connected to zone 1 (No zone sensor error), mixing valve and zone pump will not operate.

- During Extension System (Optional PCB connected)

- 1) Buffer Tank connection select "NO" &
  - One zone system is select
    - a) This zone room temperature control by either one of the 4 room sensor (Room Th, Int/Ext Room Thermostat, Water temp.)
    - b) Target Zone Water Temperature calculate base on selected temperature control type (Compensation or Direct) and selected room sensor.
    - c) Target Water Temperature will set same as Target Zone Water Temperature
    - d) Target Water Temperature is a temperature for heat pump to operate refer to indoor water outlet sensor.
    - e) Heat pump and water pump OFF when ROOM Thermo OFF (Zone thermo OFF by Room Th or Room Thermostat).

\* There will be no zone sensor connected to zone 1 (No zone sensor error), mixing valve and zone pump will not operate.

- 2 zone system select
  - a) Each zone room temperature is control by each sensor which select from either one of the 4 room sensor
  - b) Target Zone 1 & 2 Water Temperature is calculated based on selected temperature control type (Compensation or Direct) and selected room sensor.
    - \* Zone Mixing Valve & Zone pump will operate to achieve Target Zone Water Temperature which refer to zone sensor.
    - \* Zone Sensor will detect if zone sensor is open or short.
  - c) Target Water Temperature will set same as the active & higher zone water temperature setting. (When cooling mode, lower zone water temp setting)
  - d) Target Water Temperature is the temperature for heat pump to operate refer to indoor water outlet sensor.
  - e) Heat pump and water pump OFF when ROOM Thermo OFF (Both Zone thermo OFF by Room Th or Room Thermostat).

- 2) Buffer Tank Connection select "YES" &
  - o 1 zone system or 2 zone system select
  - a) Each zone control by each sensor which select from either one of the 4 room sensor
  - b) Target Zone 1 & 2 Water Temperature calculate base on selected temperature control type (Compensation or Direct) and selected room sensor. Each zone have their own Target Zone Water Temperature.
    - \* Zone Mixing Valve & Zone pump will operate to achieve each Target Zone Water Temperature which refer to zone sensor
    - \* Zone Sensor will detect if zone sensor is open or short.
  - c) Target Buffer Tank Temperature will be set as active & higher zone water temperature setting + Buffer Delta T. (Heating) Target Buffer Tank Temperature will be set as active & lower zone water temperature setting (Cooling).
  - d) Target Water Temperature will set as Target Buffer Tank Temperature + [2°C] (Heating) Target Water Temperature will set as Lower or Active Target Zone Water Temp. + [-3°C] (Cooling)
  - e) Target Water Temperature is a temperature for heat pump to operate refer to indoor water outlet sensor.
  - f) Heat pump and water pump OFF when ROOM thermo OFF
    - Heat mode: ROOM thermo OFF (Buffer Tank Temperature > Target Buffer Tank + [0°C]
    - Cool mode: ROOM Thermo OFF (Both Zone thermo OFF by Room Th or Room Thermostat)

### 12.1.7 Auto Mode Operation

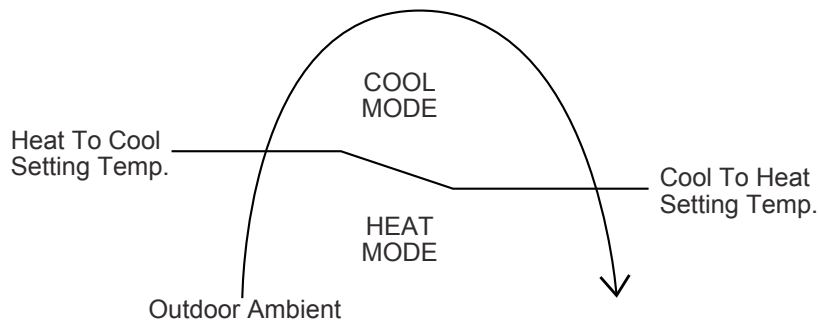

- Control details:
  - o To enable the unit to operate either heat or cool mode automatically, heat to cool set temperature and cool to heat set temperature can be set by control panel.
  - o Automatic operation is judged based on control panel setting temperature and outdoor ambient temperature.
  - \* Minimum setting of heat to cool set temperature is 1°C higher than cool to heat set temperature.
- Judgement control:
  - o If outdoor ambient temperature < Heat to Cool Set Temperature, unit will operate in Heat Mode or else the unit will operate in Cool Mode.
  - o If current operation is Cool mode, outdoor ambient temperature > Cool to Heat Temperature, unit will maintain Cool mode operation or else the unit will operate Heat mode.
  - o If current operation is Heat mode, outdoor ambient temperature > Heat to Cool Temperature, unit will maintain Heat mode operation or else the unit will operate Cool mode.
  - o Every 60 minutes the outdoor ambient temperature is judged.
  - o When Auto + Tank mode is selected, operation mode switching is judged by both outdoor ambient temperature and indoor air temperature.



### 12.1.8 Auto Cooling Mode Operation Limit

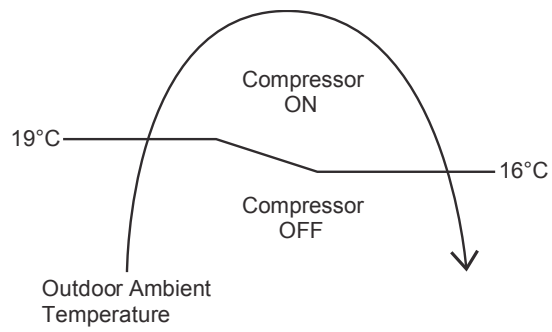

- Auto Mode Cooling Only operation will start once the outdoor ambient temperature reaches 19°C and compressor will continue to run until the outdoor ambient temperature drops to 16°C.
- Due to this limitation, If Heat to Cool temperature is set lower than 19°C, the compressor will not operate until the outdoor ambient temperature reaches 19°C or higher.

## 12.1.9 Tank Mode Operation

- 3 ways valve direction
  - 3 ways valve switch to tank side during Tank Thermo ON condition. Switch 3 ways valve to room side when tank achieve Tank Thermo OFF temperature.
- Tank Thermo ON/OFF Characteristic
  - Tank Thermo OFF

Case 1: Internal Tank Heater is select and Tank Heater ON

- a) Tank temperature > Tank Set Temperature continuously for 15 seconds.
- b) Water outlet >75°C

Case 2: Tank Heater OFF OR External Heater is select

- a) When heat pump OFF due to water thermos & Tank temperature > Tank water set temperature for continuously 20 seconds. **OR**
- b) Tank temperature > Tank set temperature + 1°C for continuously 20 seconds.

- Tank Thermo ON

Case 1: Internal Tank Heater is select and Tank Heater ON

- a) Tank temperature < Tank set temperature + R/C (Tank re-heat temperature)

Case 2: Tank Heater select OFF OR External Heater is select

- a) Tank temperature < Tank water set temperature + R/C (Tank re-heat temperature)

\* When tank thermo ON, water pump will ON for 3 minutes then only heat pump turn ON.

\* Tank water set temperature = tank set temperature or 51°C whichever lower.

- 2 ways valve close
- Heat pump Thermostat Characteristic
  - Heat pump Water Outlet set temperature is set to below table:

Outdoor ambient temperature	Heat pump water outlet temperature
< 5°C	55°C
> 5°C	57°C

Characteristic of heat pump thermos ON/OFF under tank mode condition:

- 1) Water Outlet Thermo Condition
  - Heat pump thermos OFF temperature:
    1. Heat pump thermo OFF temperature = Target Water outlet temperature + (2°C)
    2. Water outlet temperature > heat pump thermo OFF temperature for continuously 3 minutes, heat pump OFF but water pump continue ON.
  - Heat pump thermo ON temperature:
    1. Heat pump thermo ON temperature = water inlet during thermo OFF time + [-3°C]
    2. When water outlet temperature < heat pump thermo ON temperature, heat pump ON.
- 2) Water inlet thermo protection condition
  - Heat pump thermo OFF temperature:
    1. Water inlet temperature > [57°C/55°C] for continuously 30 seconds, heat pump OFF, water pump continue ON.
  - Heat pump thermo ON temperature:
    1. Heat pump thermos ON temp = water inlet temperature < [57°C/55°C].

Outdoor ambient temperature	Water inlet temperature
< 5°C	55°C
>= 5°C	57°C

### Thermo ON/OFF for Heat Pump in Tank Operation:

- 1) When tank temperature achieve heat pump OFF condition, refer below condition:

#### Condition 1: When Internal Tank Heater is select and Tank Heater ON

- Heat pump will turn OFF, water pump continue ON and room heater will continue ON if tank temperature below tank heater thermo ON condition. 3 ways valve will only switch to room side after tank temperature reach tank heater thermo OFF condition.

#### Condition 2: When Tank Heater select OFF **OR** when External Tank Heater is select and Tank heater ON

- If tank temperature achieve tank thermo OFF, heat pump turn OFF, water pump turn OFF, room heater OFF and 3 ways valve switch to room side.

- 2) When tank temperature achieve heat pump ON condition, water pump ON, heat pump ON and room heater turn OFF.

### Heat pump OFF condition at Tank Mode

- a) Tank temperature > tank water set temperature continuously for 20 seconds after heat pump thermos OFF due to water thermo. (Heat pump turn OFF but water pump continue ON and room heater turn ON to achieve tank set temperature) **OR**
- b) Tank temperature > tank set temperature + [1°C] for continuously 20 seconds. (Heat pump OFF, water pump OFF, room heater OFF and 3 ways valve switch to room side)

### Heat pump ON condition at Tank Mode

- a) Tank temperature < tank water set temperature + R/C setting (Tank re-heat temp)  
(Water pump turn ON **OR** continue ON, heat pump ON and 3 ways valve switch to tank side or maintain at tank side)

- Internal heater control
  - Internal heater only operates to tank side if the Internal Tank Heater is select, Tank heater ON and backup heater is enable.

### Internal heater turn ON condition:

- 1) Tank temperature < tank set temperature **AND**
- 2) Heat pump thermos OFF **AND**
- 3) 20 minutes from previous heater off **AND**
- 4) Internal tank heater selects USE from control panel.

### Internal heater turn OFF condition:

- 1) Tank temperature > tank set temperature for continuously 15 seconds **OR**
- 2) Heat pump thermo ON **OR**
- 3) Mode change or operation is off by control panel.

- External Heater control
  - External heater only operate to tank side if tank heater ON & External Heater select.

## 12.1.10 Heat + Tank Mode Operation

1. 3 ways valve control:
  - 3 ways valve switch to room side during room heat-up interval and switch to tank side during tank heat-up interval. Both modes will switch alternately. Tank mode is the initial running mode of Heat + Tank mode.
  
2. Heat pump operation control:
  - a) During room heat-up interval
    - Follow normal heating operation.
    - Switching to tank side depends to below cases:
      - Case 1:  
[Previous switch from tank interval to room interval due to thermo OFF]
        - Switch to tank heat-up interval when Tank temp < Tank thermostats ON temp (Room heat-up interval ends)
      - Case 2:  
[If heating operation at room side is less than 30 minutes and switch to tank side 3 times consecutively]
        - Maintain at room heat-up interval regardless of the tank temperature. Switch to tank heat-up interval only when (Room Interval Timer is complete **OR** Room heat pump thermo OFF) **AND** Tank temperature < Tank thermostat ON temperature.
      - Case 3:  
[Previous switch from tank interval to room interval due to tank interval timer is complete]
        - Maintain at room heat-up interval regardless of the tank temperature. Switch to tank heat-up interval only when (Room Interval Timer is complete **OR** Room heat pump thermo OFF) **AND** tank temperature < Tank thermostat ON temperature.
  - b) During Tank heat-up interval
    - Tank interval is the first mode running when heat + tank mode is select.
    - Switch to room interval only when tank achieve tank thermostat OFF **OR** tank heat-up interval timer is complete.
    - Heat pump operates according to normal tank mode operation.
  
3. Room heater control:
  - a) During heating heat-up interval
    - Follow normal room heater control operation.
  
4. Tank heater control:
  - a) During heating heat-up interval
    - i. If External tank heater is select.
      - External heater ON/OFF according to external tank heater operation control.
    - ii. If internal tank heater is select.
      - Internal tank heater will not function under heating heat-up interval.
  - b) During tank heat-up interval
    - i. If External tank heater is select.
      - Once heating heat-up interval switched to tank heat-up interval, tank heater is turn OFF and tank heater delay timer will start counting.
      - Tank heater will turn ON after tank heater delay timer is fulfill and tank temperature is lower than tank set temperature.
      - Tank heater delay timer is clear when switching to heating heat-up interval.
    - ii. If internal tank heater is select.
      - Internal tank heater will turn ON after heat pump thermo off to boil tank temperature to tank set temperature.
  
- c) 2 ways valve control is open
  
- d) Indoor water pump control:
  - Indoor water pump always turn ON if room heat pump thermostat ON **OR** Tank thermostat ON.

### 12.1.11 Cool + Tank Mode Operation

1. 3 ways valve control:
  - 3 ways valve switch to room side during room cooling interval and switch to tank side during tank heat-up interval. Both mode will switch alternately. Tank mode is the initial mode of cool + tank mode.
  
2. Heat pump operation control:
  - a) During room operation interval
    - Follow normal cooling operation.
    - Switch to Tank side depends on below case:
 

Case 1:  
[Previous switch from tank interval to room interval is due to tank thermo OFF.]

      - Switch to tank heat-up interval when Tank temperature < Tank Thermo ON temperature (Room interval will ends)

Case 2:  
[If cooling operation at room side is less than 30 minutes and switch to tank side for 3 times consecutively]

      - Maintain at room cooling interval regardless of the tank temperature. Switch to tank heat-up interval only when (Room interval timer is complete **OR** Room heat pump thermo OFF) **AND** Tank temperature < Tank thermo ON temperature.

Case 3:  
[Previous switch from tank interval to room interval is due to tank interval timer is complete]

      - Maintain at room cooling interval regardless of the tank temperature. Switch to tank heat-up interval only when (Room interval timer is complete **OR** Room heat pump thermo OFF) **AND** Tank temperature < Tank thermo ON temperature.

\*Tank Thermo ON temperature:

Internal Tank Heater select USE	<Tank set temperature + R/C setting (Tank re-heat temperature)
Others	<Tank water set temperature + R/C setting (Tank re-heat temperature)

- b) During tank heat-up interval
  - Tank interval is the first mode running when the cool + tank mode is select.
  - Switch to room interval only when tank achieve tank thermo OFF **OR** tank heat-up interval timer is complete.
  - Heat pump operates according to normal tank mode operation.
  
3. Room heater control:
  - a) During room cooling interval
    - Room heater is OFF and not operates.
  
4. Tank heater control:
  - a) During room cooling interval
    - i. If external tank heater is select.
      - External heater ON/OFF according to external tank heater operation control.
    - ii. If internal tank heater is select and tank heater ON
      - Internal tank heater will not function under room cooling interval.
  - b) During tank heat-up interval
    - i. If external tank heater is select
      - Once room cooling interval switch to tank heat-up interval, tank heater will turn OFF and tank heater delay timer will start counting.
      - Tank heater turns ON after tank heater delay timer is fulfill and tank temperature is lower than tank set temperature.
      - Tank heater delay timer is clear when switch to room cooling interval.
    - ii. If internal tank heater is select and tank heater ON.
      - Internal tank heater will turn ON after heat pump thermos off to boil tank temperature to tank set temperature.

5. 2 ways vale is close.

6. Indoor water pump control:

- Indoor water pump always turn ON if room heat pump thermo ON **OR** Tank thermo ON.

### 12.1.12 Outdoor Fan Motor Operation

Outdoor fan motor is adjusted according to operation condition. It starts when compressor starts operation and it stops 30 seconds after compressor stops operation.

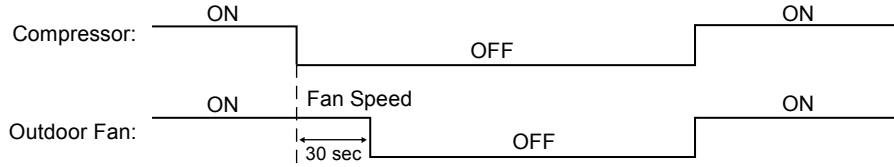

## 12.2 Water Pump

### 12.2.1 Water Pump Control

- Once the indoor unit is ON, the water pump will be ON immediately and no error judgment for 70 seconds. However, during this 70 seconds operation, if there is any abnormality cause at outdoor or malfunction, the compressor should be OFF immediately and restart delay after 3 minutes.
- The system will start checking on the water flow level after operation start for 70 seconds. If water flow level is detected low continuously 60 seconds, the water pump and the compressor will be OFF permanently and OFF/ON control panel LED will blink (H62 error occurs).
- When error happens, the power has to be reset to clear the error.
- If there is no error indication, the water pump shall be continuously running.
- The water pump will remain ON when compressor OFF due to thermostat OFF setting is reached.
- Water pump will OFF when room thermo **OR** tank thermo **OR** buffer tank thermo OFF.
- Water pump will delay 15 seconds to turn OFF when request to OFF except during anti-freeze deice activate or air purge mode.

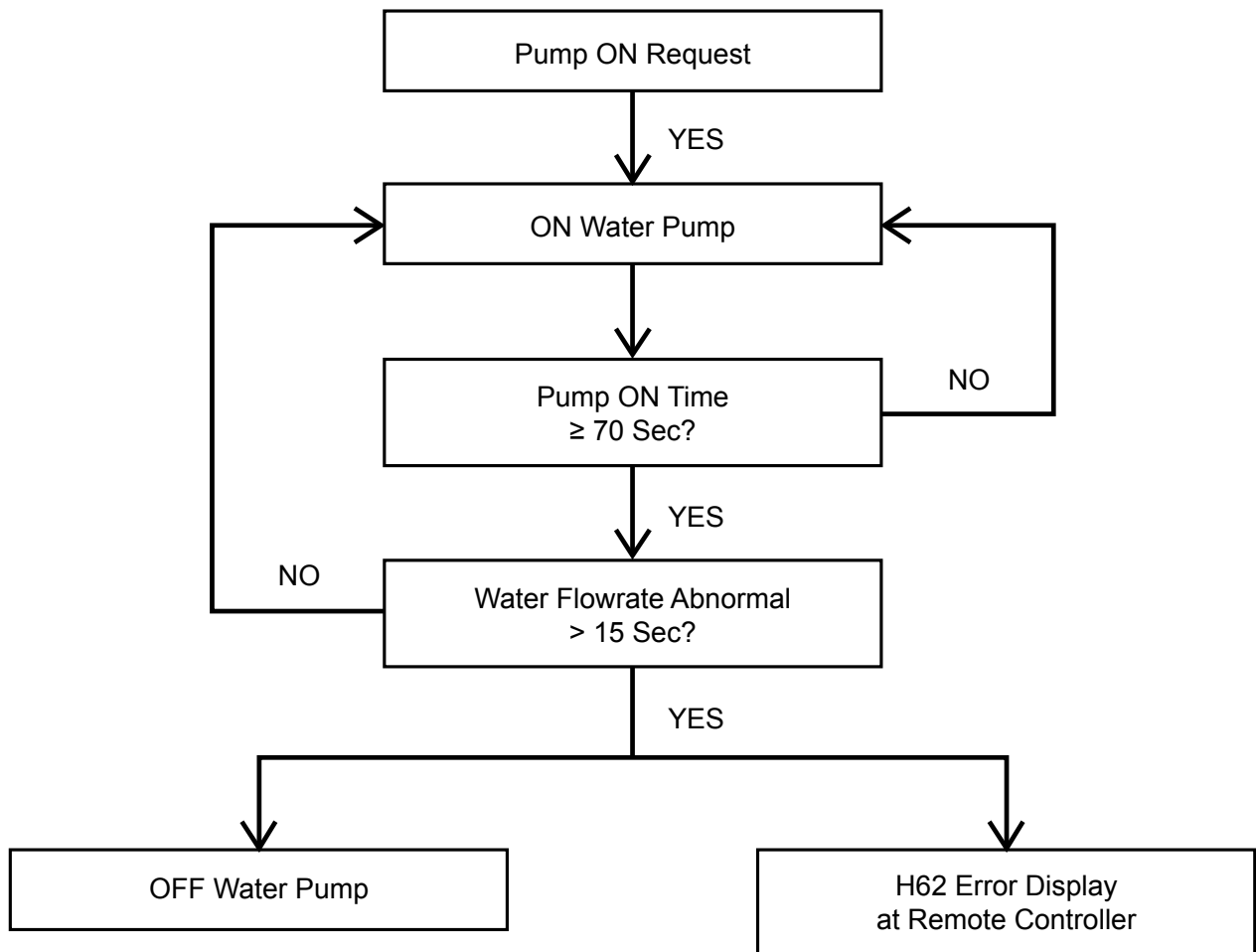

### Maximum pump speed setting on remote control

- Standard pump speed is automatically controlled to get the designed water temperature different between water inlet and outlet ( $\Delta T$ ). Instead of setting the standard pump speed, maximum pump speed is manually adjusted by the installer according to water circuit pressure drop.

However, the following sequences do not follow maximum pump duty setting by remote control.

- Pump down mode
- Air purge mode
- Normal deice

#### 1) P-Q graph for different pump HEX duty

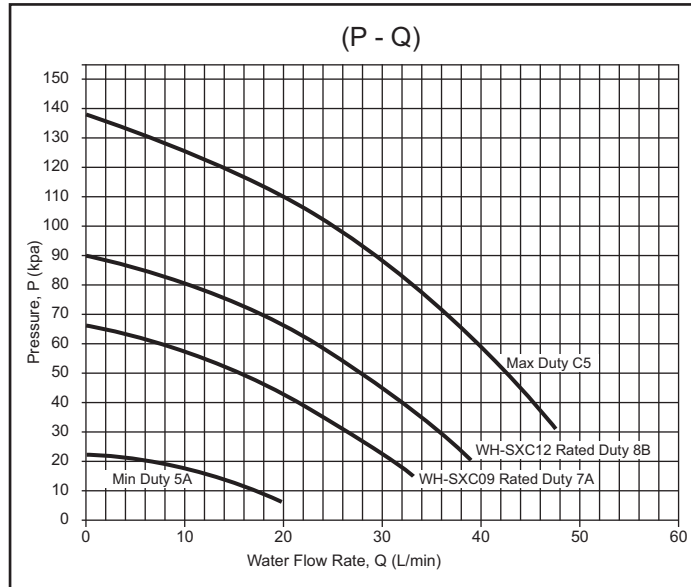



## 12.2.2 Zone Water Pump Control

Purpose:

- Water pump install at each zone to circulate the water inside each zone during buffer tank connection selected "YES" or 2 zone systems.

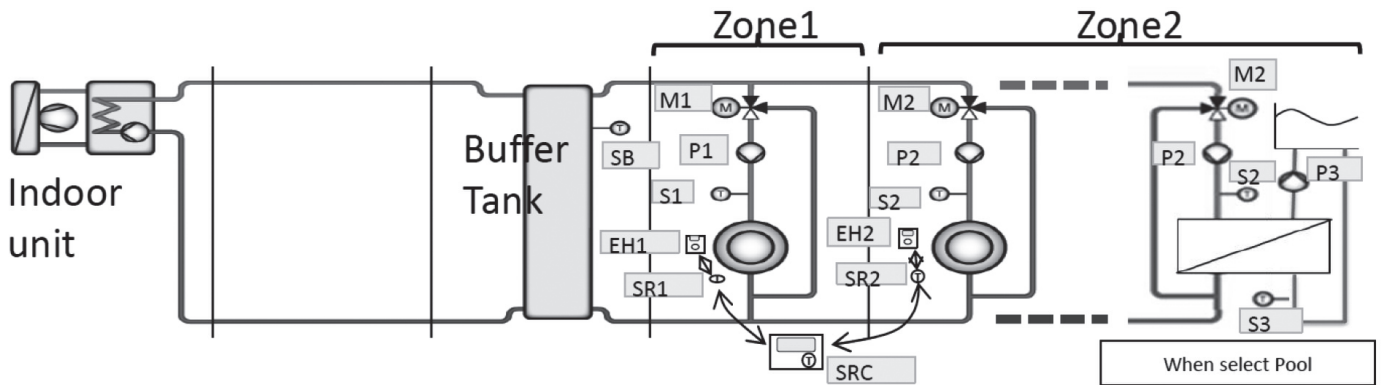

Content:

- AC type water pump install for this zone water pump control. When optional PCB connected, 230V output will drive this zone pump.
- There are three pump can be connected through Optional PCB. (Zone 1 Pump, Zone 2 Pump, & Pool Pump)

\* Zone 1 pump [P1] use to circulate zone 1 water circuit & Zone 1 mixing valve [M1] adjust to control the Zone 1 target water temperature.

\* Zone 2 pump [P2] use to circulate zone 2 water circuit & Zone 2 mixing valve [M2] adjust to control the Zone 2 target water temperature.

\* When Pool Function select as Zone 2 circuit, [P2] use to circulate water to heat exchanger which use to transfer heat to pool water.

\* Pool pump [P3] circulates the pool water through the heat exchanger to get warm water.

- Zone 1 and Zone 2 water pump start condition:
  - Zone room request ON  
(eg. Zone 1 thermo ON, only zone 1 pump will turn ON)
- Zone 1 and Zone 2 water pump stop condition:
  - Zone room request OFF
- Pool water pump start condition:
  - Pool Zone request ON **AND**
  - Pool function is selected
- Pool water pump stop condition:
  - Pool zone: Zone room request OFF **OR**
  - Pool function is cancel

\* Zone 1 & Zone 2 water pump need to turn OFF when antifreeze deice pump stop control activate and turn ON back after the antifreeze deice pump stop control end under setting of "NO" buffer tank connection.

### Zone Pump Prohibit ON control:

- Start condition:
  - Zone 1 water temperature  $\geq 75^{\circ}\text{C}$  continuously for 5 minutes
  - \*stop zone water pump operates if the zone water fulfilled.
- Cancel condition:
  - After 30 minutes from start condition fulfilled.
  - \*zone water pump operates according to normal condition.

### Zone Pump Control during Anti-Freeze

Zone pump control during Zone Anti-Freeze Control:

When Zone Anti-Freeze Flag=1, Zone Pump Turn ON.

When Zone Anti-Freeze Flag=0, Zone Pump Turn OFF.

Zone pump control during Indoor Anti-Freeze Control:

- Zone pump only ON/OFF if the Extension PCB connected and Buffer Tank select "NO" condition

When Indoor Anti-Freeze flag=1, Zone Pump Turn ON

When Indoor Anti-Freeze flag=0, Zone Pump Turn OFF

\* Pool Water Pump will not be affected by both Indoor anti-freeze control or zone anti-freeze control.

### 12.2.3 Water Pump Speed Feedback Error

- Basically pump speed feedback is controlled by micon.
- When pump speed is below low limit or over high limit for a few seconds, micon detects pump error and the system is stopped.
- Error detection conditions:
  - Detect abnormal water pump speed for continuous 10 seconds.
  - Current pump speed < 700 rpm or
  - Current pump speed > 6000rpm for 10 seconds.
- Control contents:
  - When error occurs, water pump, heating and heater are stopped for 30 seconds then restart again (Retry control).
  - When micon detects error again, the system is stopped and error code [H20] is displayed at the control panel.

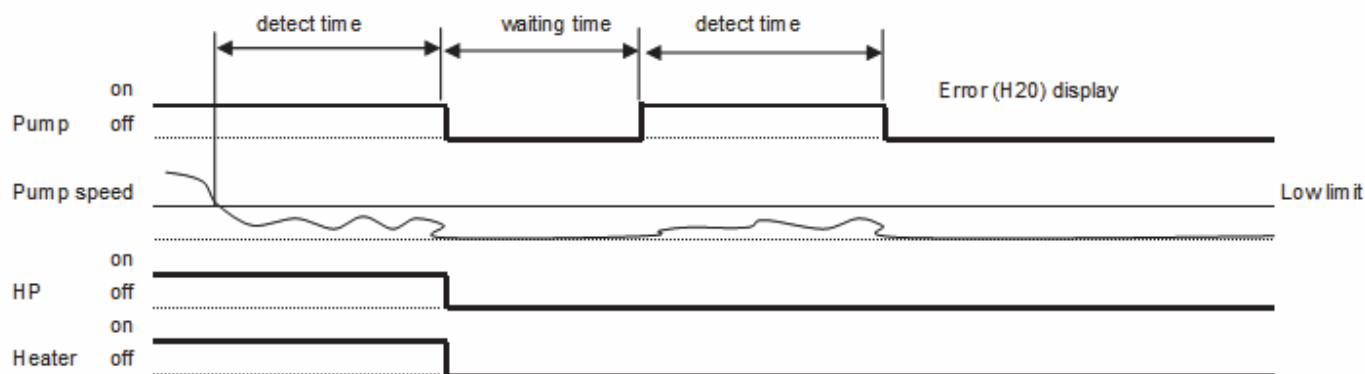

## 12.3 Indoor Unit Safety

### 12.3.1 Indoor Unit Safety Control

- 1 When water pump is ON, the system will start checking flow switch status (ON/OFF).
- 2 If the flow switch ON for 10 seconds, the system will check on the water inlet temperature for 10 seconds. If the water inlet temperature not exceeds 80°C, the water pump shall be continuously running with normal mode.  
If the water inlet temperature exceeds 80°C for continuously 10 seconds, the water pump will be OFF immediately.
- 3 After water pump OFF for more than 10 minutes, it will be ON back and the indoor unit safety control checking is restarted.

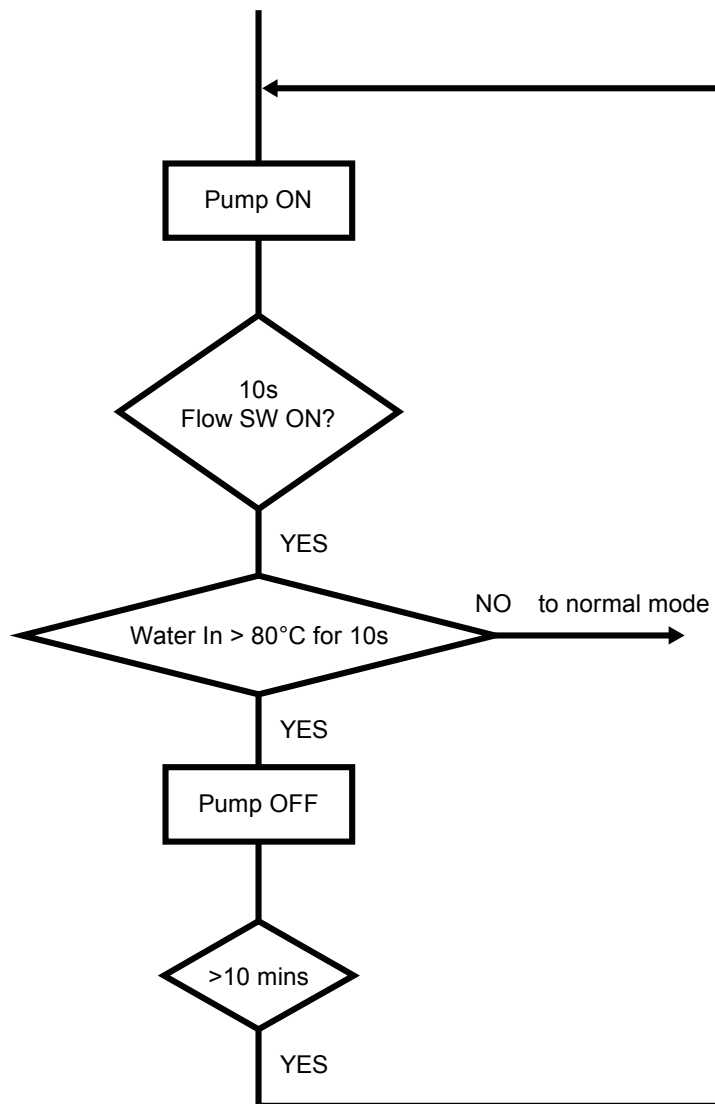

### 12.4 Auto Restart Control

- 1 When the power supply is cut off during the operation of Air-to-Water Heatpump, the compressor will re-operate after power supply resumes.

### 12.5 Indication Panel

LED	Operation
Color	Green
Light ON	Operation ON
Light OFF	Operation OFF

Note:

- If Operation LED is blinking, there is an abnormality operation occurs.

## 12.6 Indoor Back-Up Heater Control

### 12.6.1 Indoor Electric Heater Control

- 1 Normal Heating Mode
  - Heater On condition:
    - a. Heater switch is ON
    - b. After Heatpump thermo ON for **[30]** mins
    - c. After water pump operate **[9]** mins
    - d. Outdoor air temperature < Outdoor set temperature for heater
    - e. When water outlet temperature < Water set temperature + **[-4°C]**
    - f. **[20]** minutes since previous Backup heater Off
      - \* When heatpump cannot operate due to error happens during normal operation, heater will go into force mode automatic
      - \* Heater need to operate during deice operation
  - Heater Stop Condition:
    - a. When outdoor set temperature > outdoor set temperature + **[+2°C]** for continuous 15 secs OR
    - b. When water out temp > water set temperature + **[-2°C]** for continuous 15 secs OR
    - c. Heater switch is Off OR
    - d. Heatpump thermo-off or OFF condition
- 2 Force Heater Mode
  - Heater On condition:
    - a. After water pump operate **[9]** mins
    - b. When water outlet temperature < water set temperature + **[-4°C]**
    - c. **[20]** minutes since previous Backup heater Off
  - Heater Stop condition
    - a. Force mode off **OR**
    - b. When water outlet temperature > water set temperature + **[-2°C]** for continuous 15 secs

\* Do not operate heater at the following situation

- 1 Water outlet temperature sensor, and water inlet sensor abnormal
- 2 Flow switch abnormal
- 3 Circulation pump stop condition

## 12.6.2 Room Heater Operation during Deice

### Purpose:

- To protect the indoor Heat Exchanger from ice forming and prevent heat exchanger plate breakage.

### Control content:

- This Heater protection control will activate only if the backup heater is enable at custom setup by remote controller. Once fulfil the start condition, room heater will turn ON together (base on max heater capacity selection) and stop together if stop condition is fulfilled.
- \* If the heater is request to turn ON OLP feedback will be detected.

### Starting conditions:

1. During normal deice operation 4~9
2. Water outlet temperature < 10°C or Outdoor air temperature < -10°C or Water inlet temperature < 27°C

Heater operates when 1 ~2 fulfilled **OR** When 1 and 3 ~ 4 is fulfilled.  
However, this control does not relate to Heater ON/OFF button on remote control.

### Stop condition:

1. When normal deice end or
2. Water outlet temperature > 45°C

However, room heater keeps ON if indoor electric heater control activate.

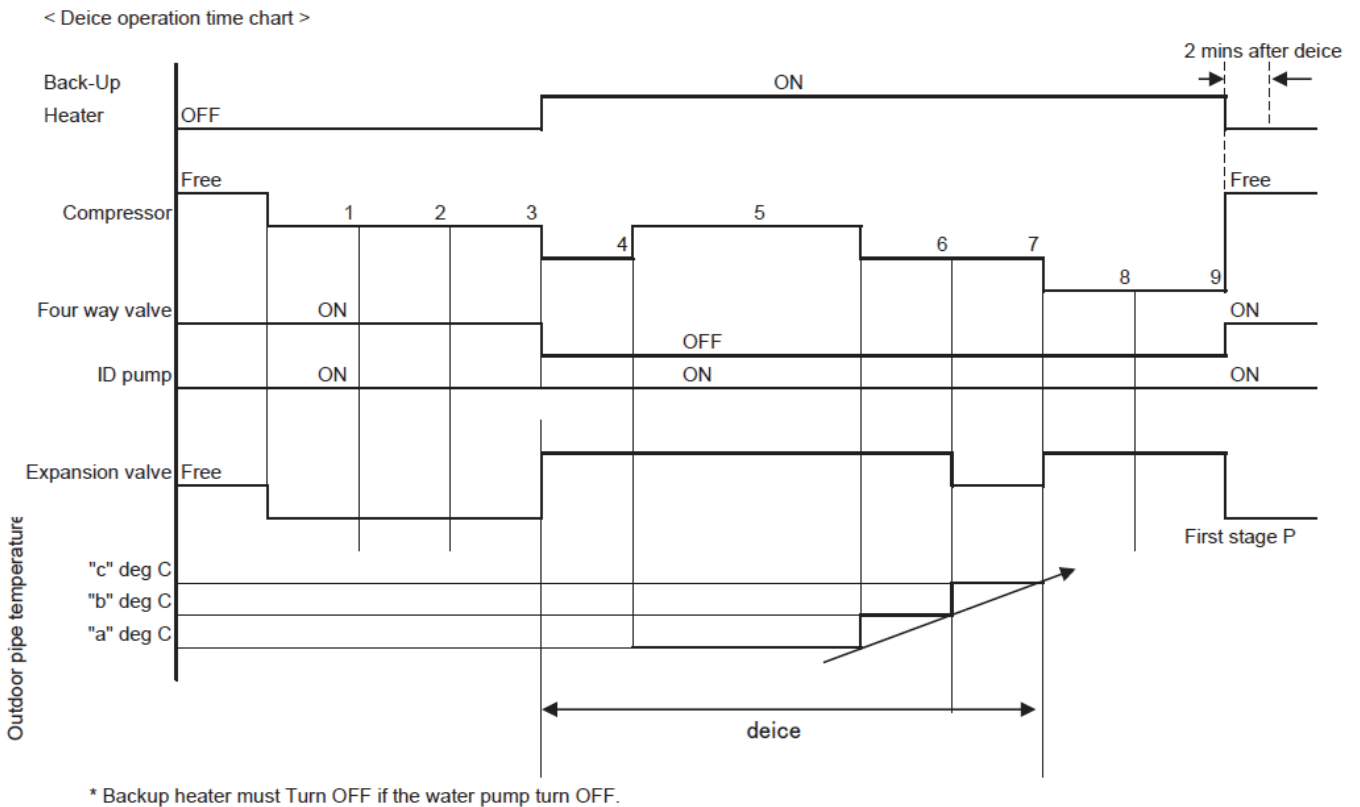

## 12.7 Tank Heater Control

### 12.7.1 Tank Heater Remote Control Setting

- 1) Tank heater selection:  
 External: - Booster Heater use to heat up tank when select external  
 Internal: - Backup Heater use to heat up tank when select internal  
 \* When select External Tank Heater, Heater Delay ON Timer need to set. (range 20 min ~ 3 hrs)
- 2) Tank Heater ON/OFF selection by user.

The remote control Tank set Temperature range will change according to the External and Internal Tank Heater use.

Tank Heater Selection	Range
External	40 ~ 75°C
Internal	40 ~ 65°C

### 12.7.2 External Heater Control at Tank Side

Heating operation condition:

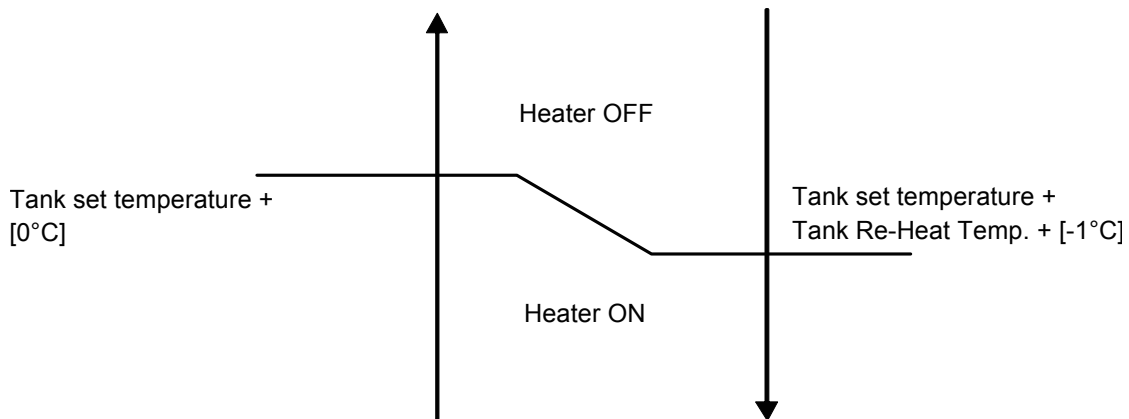

- a) Tank heater Turn On condition:
  - External Heater select for Tank heater by remote controller.
  - Tank Heater select ON by user.
  - Tank mode operation ON ( Tank mode, Heat + Tank, or Cool + Tank )
  - After TANK HEATER DELAY TIMER fulfil during heat pump startup time in tank mode, or during switching from heating heat-up interval to tank heat-up interval in heat + tank mode
  - Tank temperature < tank set temperature + [Remote controller Set Tank Re-heat Temp] + [-1°C]
  - 20 minutes since previous heater off.

\* TANK HEATER DELAY TIMER is clear when tank heat-up interval end.
- b) Tank heater Turn Off condition:-
  - Tank temperature > tank set temperature + [0°C] for continuous 15 seconds.
  - When BOOSTER HEATER DELAY TIMER start count after switch from heating heat-up interval to tank heat-up interval.
  - Tank Heater select OFF by user
  - Tank Mode Operation OFF

### 12.7.3 Internal Heater Control at Tank Mode

- Internal heater turn ON condition:
  - 1) Internal Heater select for Tank heater by remote controller
  - 2) Tank Heater select ON by user.
  - 3) Backup Heater Enable
  - 4) Tank Temperature < Tank Set Temperature
  - 5) Heat Pump Thermo OFF
  - 6) 20 minutes from previous heater off.
- Room heater turn OFF condition:
  - 1) Tank Temperature > Tank Set Temperature + [0°C] for continuous 15 seconds. **OR**
  - 2) Heat Pump Thermo ON **OR**
  - 3) Mode Change or Operation OFF by remote controller **OR**

\* Backup Heater Turn ON/OFF all together according to the selected heater capacity.

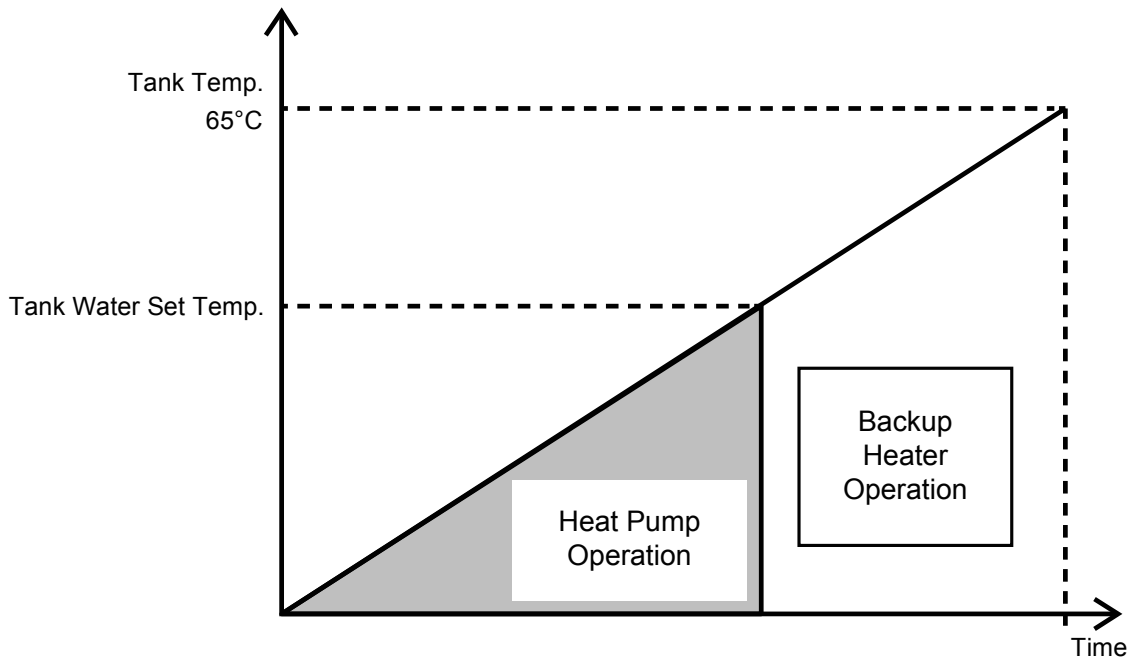

## 12.8 Base Pan Heater Control (Optional)

- To enable the base pan heater function, control panel initial setting has to be manually adjusted by activating Base Pan Heater menu.
- There are 2 optional start condition can be selected, Type A or Type B.
- Control details:
  - 1 Type A: (Default Auto Mode)
    - Start conditions:
      - When outdoor air temperature  $\leq 3^{\circ}\text{C}$  during heating and deice operation is ON.
    - Control contents:
      - Base pan heater is ON during deice operation and continues ON for 10 minutes after deice operation ends.
    - Cancel condition:
      - When outdoor temperature  $> 6^{\circ}\text{C}$  after deice end or
      - When operation is not at heating mode or
      - Base pan heater ON timer count is completed.
  - 2 Type B: (ON Mode)
    - Start conditions:
      - When outdoor air temperature is  $\leq 5^{\circ}\text{C}$  and operates in heating mode, base pan heater is ON.
    - Cancel conditions:
      - When outdoor air temperature is  $> 7^{\circ}\text{C}$  or
      - When operation is not at heating mode.

## 12.9 Heater Turn ON/OFF priority Control

Purpose:

- To allow only one heater between room and tank heater to turn ON at the same time due to both heater power supplies is sharing the same ELCB. Prohibit two heater sources to turn ON at the same time to avoid overcurrent.

Start condition:

- Tank heater function select YES by remote controller

Control contents:

- a) When there is only one heater source (Room Heater or Tank Heater) request to turn ON, operate same as normal room heater and tank heater operation.
- b) When both backup heater and booster heater request to turn ON at same time, will turn ON only ONE heater source. Under normal condition, tank heater has priority to turn ON except below condition.
  - i. Backup Heater Priority to Turn ON when
    - Request Backup heater turn ON at Hex Protection control during deice.
    - Request Backup Heater turn ON at Hex Protection Control during low water temperature.
    - Request Backup Heater turn ON at Anti-frost control.
    - Heat pump error and Force Mode operate.
- c) When switching from booster heater to backup heater **OR** backup heater to booster heater, need to delay 5 seconds in between Turn OFF one heater source and Turn ON another heater source.



## 12.10 Force Heater Mode

### Purpose of Force Heater Mode

- As a backup heat source when heat pump error. Force heater Mode control backup heater to heat up the room circuit, and turn ON back up heater or booster heater to boil up tank water base on the tank heater selection (internal or external)

### Force Heater Control start condition:

- Force heater request ON by user OR auto turn ON by remote controller during error **AND** (Force Heater mode can be operate regardless of mode selection, remocon will send the lastest mode selection and force bit to indoor. Indoor will judge to turn ON heater to room side if it is heat mode selected, and turn ON heater to heat up tank water base on tank heater selection)
- During Error Happen (exclude the error list below)

### Error List not allow Force Heater Operation

H12	Capacity Mismatch	H76	Indoor-Remote Controller Communication Error
H20	Abnormal Water Pump	H95	Abnormal Voltage Connection
H62	Abnormal Water Flow	F37	Abnormal Water Inlet sensor
H70	Abnormal Back-up Heater OLP	F45	Abnormal Water Outlet sensor
H74	PCB Communication Error		
[ When tank mode operate with external heater selected & tank heater select ON]			
H72	Abnormal tank sensor	H91	Abnormal tank heater OLP

### Force Heater Control Stop Condition:

- Force Heater request OFF **OR**
- Operation OFF request **OR**
- Power reset **OR**
- Error of above list happens during force heater operation.

### Control contents:

- 1) After fulfill start condition, indoor will operate the force heater operation according to below mode condition
  - Heat mode Only : Turn ON backup heater to achieve room heat pump target water temperature.
  - Heat + Tank mode : Turn ON backup heater to heat up room **OR** Turn ON Heater to Boil up tank water.
  - Cool mode Only : Water pump and backup heater will OFF in force heater mode
  - Cool + Tank mode : Operate pump and internal Heater OR External heater to Boil up tank water.
  - Tank mode Only : Operate pump and internal Heater OR External heater to Boil up tank water.
  - \* For heat mode condition, backup heater will only turn ON if the backup heater is enable regardless of Room Heater Selection
  - \* For tank mode condition, If internal heater selected backup heater will turn ON to boil up tank water. If external heater selected, booster heater will turn ON to boil up tank water regardless of tank heater selection

### Room Side: (Heat Mode)

- 1) When force heater mode start condition fulfilled, turn ON water pump and turn ON backup heater follow below control.
- 2) Operate the 3 ways valve at room side only and turn ON 2 ways valve as heat mode operation.
- 3) Turn ON the zone pump and mixing valve if system select 2 zone system or Buffer tank connect YES, control according to normal zone pump and mixing valve control.
- 4) When Force heater mode stop condition fulfilled, turn OFF heater as below condition and turn OFF water pump after pump delay time.

### Backup Heater On Condition:

- a) When Force Heater Control start condition fulfill **AND**
- b) After water pump operate 2 minute **AND**
- c) When water outlet temperature < water set temperature + [-4°C] **AND**
- d) 20 minutes since previous Backup heater Off **AND**
- e) Backup Heater Enable

### Backup Heater Stop condition

- a) Force mode off **OR**
  - b) Operation off **OR**
  - c) When water outlet temperature > water set temperature + [-2°C] for continuous 15 secs **OR**
- \* ON/OFF follow normal heater sequence.

#### Tank side (Tank mode)

- 1) When tank mode select and force heater bit received, turn ON backup heater (INTERNAL) or Booster Heater (External) depend on the tank heater selection.
- 2) If tank heater selection is INTERNAL, follow normal thermo judgement to switch 3 ways valve to tank side and room side.
- 3) If tank heater selection is EXTERNAL, only turn ON booster heater according to tank thermo.

#### **Tank Heater selection is INTERNAL:**

##### Backup Heater ON Condition:

- a) After water pump operate 2 mins **AND**
- b) When tank temperature < Tank set temperature - [Remocon Set Tank Re-heat Temp] **AND**
- c) 20 minutes since previous backup heater OFF **AND**
- d) Backup heater enable

##### Backup Heater OFF Condition:

- a) Force mode OFF **OR**
- b) When tank temperature > Tank set temperature for continuous 15 secs **OR**
- c) Tank Operation OFF

#### **Tank Heater selection is EXTERNAL:**

##### Backup Heater ON Condition:

- a) Force Heater mode ON **AND**
- b) Tank temperature < tank set temperature + [Remocon Set Tank Re-heat Temp] - 1°C, **AND**
- c) 20 minutes since previous heater off.

##### Backup Heater OFF Condition:

- a) Tank temperature > tank set temperature for continuous 15 sec
- b) Force mode OFF
- c) Tank Mode Operation OFF  
(During tank interval or tank mode condition, water pump and 3 ways valve will OFF)

## 12.11 Powerful Operation

Powerful mode is use to increase the capacity of heat pump to achieve higher target temperature. Powerful mode is applicable when heat mode is operating.

### Remote control setting:

On quick menu of remote control, there is 4 options of powerful mode can be select.

- OFF : Cancel powerful mode
- 30 minutes : Set powerful for 30 minutes
- 60 minutes : Set powerful for 60 minutes
- 90 minutes : Set powerful for 90 minutes

### Control contents:

During the time set by remote control, powerful will activate according to 2 shift up controls. However, this function is applicable only for heating. Remote control will transmit the signal to indoor unit once this function is select then transmit OFF signal to indoor when the timer is complete. Indoor will transmit signal to outdoor for frequency control.

Indoor setting temperature shift

- If system is standard system (Optional PCB is not connected)
    - Target water temperature will shift up to Wlo or Whi whichever higher.
  - If system is extension system (Optional PCB is connected)
    - Target water Zone 1 and Zone 2 temperature will shift up to Wlo or Whi whichever higher.
- \* If "Direct Type" temperature control is select, this powerful shift up setting is not effective.

### Start condition

- Powerful function is select by remote control.

### End Condition

- OFF/ON button is pressed.
- Powerful function is OFF by remote control.

## 12.12 Quiet Operation

Quiet mode is use to reduce the noise of outdoor unit by reducing the frequency or fan speed.

### Quiet level

There are 3 level (Level 1, Level 2, Level 3) to set by quick menu function on remote control.

### Control content

Once the quiet function is select, the remote control will transmit the signal to indoor and outdoor unit.

### Start condition

- Quiet mode is set on remote control.
- Quiet mode is request ON by weekly timer.

### Stop condition

If any of below condition is achieve.

- OFF/ON button is pressed.
- Quiet mode is OFF by remote control.
- Quiet mode is request OFF by weekly timer.

## 12.13 Sterilization Mode

### Purpose:

- To sterilize water tank by setting the required boiling temperature.

### Remote control setting

- Days for sterilization function to start can be select.
- Time of selected day to start sterilization function.
- Boiling temperature (External heater is 55°C ~ 75°C, Internal heater is 55°C ~ 65°C)
- Maximum operation time is 5 minutes to 1 hour.

### Start condition

- Tank connection set to "YES" by remote control
- Sterilization function selects "YES".
- Sterilization signal received from remote controller by timer.
- Tank mode request ON.

### Stop condition

- When boiling timer is completed. Boiling timer (Remote control set maximum operation time) start counting once tank achieve boiling set temperature **OR**
- After 8 hours of operation since sterilization start.
- Tank mode request OFF.

### Control content:

- During sterilization function activation time, target tank set temperature will internally change to boiling set temperature.
- During sterilization activates, heat pump and heater (external or internal) will operate as normal tank mode to achieve the boiling set temperature.
- Sterilization operation will end when stop condition is fulfill.
- After sterilization is complete, tank set temperature will resume to normal operation.

\* Tank temperature may not achieve boiling set temperature if tank heater is select OFF **OR** external compressor switch.

## 12.14 Outdoor Ambient Thermo OFF Control

### Purpose

- Stop provides heating to room side during high outdoor ambient condition.

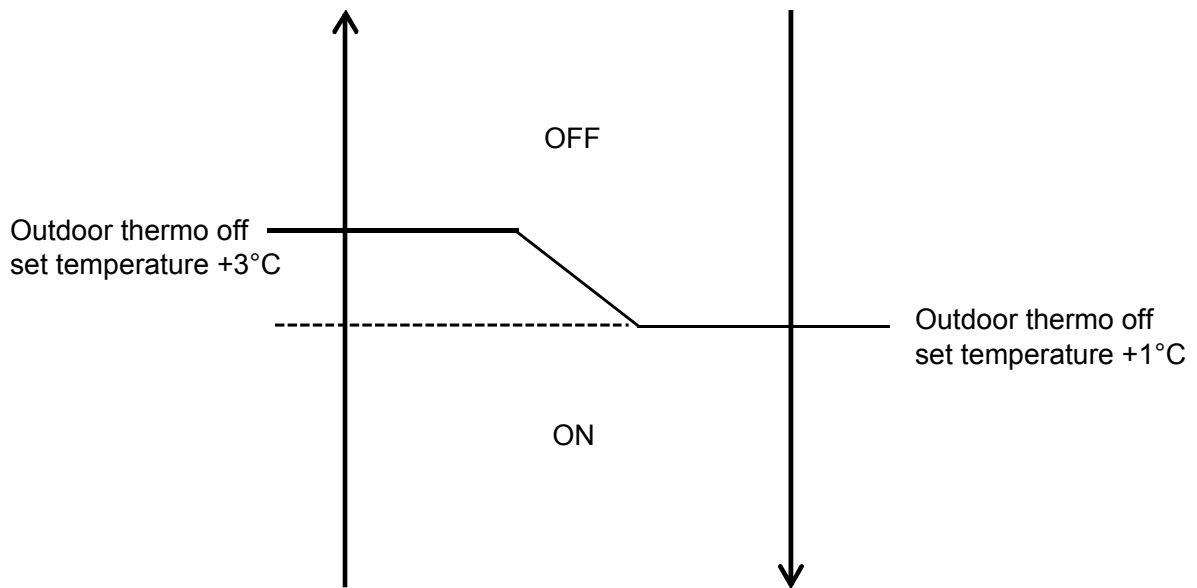

### Control content

- Heating outdoor ambient thermos OFF control only applicable when heat pump operate in heat mode. (This control will not activate when running in tank side)
- Heat pump and water pump will turn OFF when outdoor ambient is higher than outdoor thermo OFF set temperature.
- Heat pump thermos ON when outdoor ambient < outdoor thermos OFF set temperature + 1°C.

## 12.15 Alternative Outdoor Ambient Sensor Control

### Purpose of the Alternative Outdoor Ambient Sensor:

- It is some possibility that the air to water heat pump unit will install at a location where the original ambient sensor is expose to direct sunlight. Therefore, another optional ambient sensor can be connect to indoor PCB and locate at new and better reading location to improve the heat pump performance.

### Control Detail:

- Remocon can select either the extra outdoor ambient sensor is connected or not. (YES/NO)
  - The alternative outdoor ambient sensor will connect to indoor unit main PCB terminal.
- a) when alternative sensor select NO
- Original Outdoor temperature sensor will use for Indoor & Outdoor heat pump operation reference sensor.
  - Data communication direction : OUTDOOR send outdoor temperature reading to INDOOR.
  - Error judge : OUTDOOR will judge the original outdoor sensor error (F36 display if error detect). No judge error on alternative outdoor sensor
- b) when alternative sensor select YES
- Alternative Outdoor temperature sensor will use for Indoor & Outdoor heat pump operation reference sensor.
  - Data communication direction : INDOOR send outdoor temperature reading to OUTDOOR.
  - Error judge : INDOOR will judge the Extra outdoor sensor error only after operation ON request received from remocon. (F36 display if error detect). No judge error on original outdoor sensor.

## 12.16 Force DHW mode

### Purpose:

When user want to use hot water now, user can press this force DWH mode under the quick menu to operate tank only mode to boil up the tank temperature.

### Remocon setting:

Force DHW function can be activate under quick menu.

### Control Content:

- a) when press the Force DHW function during operation OFF condition:
- When receive this Force DHW bit from remocon, indoor will run tank only mode regardless of the mode selection.
  - After tank temperature achieve tank thermo off temperature, turn OFF force DHW bit and return to operation OFF with previous mode selection.
- b) When press the Force DHW function during operation ON condition:
- When receive this Force DHW bit from remocon, indoor will memories the running mode and run tank only mode regardless of the mode selection.
  - After tank temperature achieve tank thermo off temperature, turn OFF force DHW bit and return to previous memories running mode.

\* when operation OFF or mode change request from remocon during force DHW mode operation, End force DHW mode and follow the new request operation.

\* Once receive force DHW mode from remocon, indoor direct start tank mode and consider tank thermo ON. Thermo OFF only when achieve tank thermo OFF depend on the Tank System Setting.

## 12.17 Anti Freeze Control

- Anti freeze protection control menu can be set YES or NO by control panel.
- In heatpump system, there are 3 types of anti freeze control:
  1. Expansion tank anti-freeze control
    - Expansion tank anti freeze heater ON condition:
      - Outdoor ambient temp.  $< 3^{\circ}\text{C}$
    - Expansion tank anti freeze heater OFF condition:
      - Outdoor ambient temp.  $> 4^{\circ}\text{C}$
  2. Water pump circulation anti freeze control
    - Water pump turns ON when **ALL** below conditions are fulfilled:
      - Heatpump OFF (stand by) OR error occurs.
      - Water flowing flag is ON.
      - Water flow switch is not abnormal.
      - Outdoor ambient temp.  $< 3^{\circ}\text{C}$  OR outdoor ambient temp. sensor is abnormal.
      - Water inlet/outlet temp.  $< 6^{\circ}\text{C}$ .
      - After 5 minutes from previous water pump OFF.
    - Water pump turn OFF when **ANY** of below conditions is fulfilled:
      - Outdoor ambient temperature  $\geq 4^{\circ}\text{C}$ .
      - During  $-5^{\circ}\text{C} < \text{outdoor ambient temp.} < 4^{\circ}\text{C}$ 
        - After water pump ON for 4 minutes, and water inlet temp.  $\geq 8^{\circ}\text{C}$ .
        - Else, shift to back up heater anti freeze control.
      - During outdoor ambient temp.  $< -5^{\circ}\text{C}$ 
        - After water pump ON for 4 minutes, and water inlet/outlet  $\geq 20^{\circ}\text{C}$ .
        - Else, shift to back up heater anti freeze control.
    - However, if flow switch is abnormal (H62), then water pump circulation anti freeze control will not activate.
  3. Back up heater anti freeze control:
    - Back up heater turn ON when **ALL** below conditions is fulfilled:
      - Water inlet/outlet temp.  $< 6^{\circ}\text{C}$ .
      - Water pump circulation anti freeze control activated and water pump ON for 4 minutes.
    - Back up heater turns OFF when ANY of below conditions is fulfilled:
      - Water inlet/outlet temp.  $> 28^{\circ}\text{C}$ .
      - Water pump circulation anti freeze control deactivated/water pump OFF.
    - However, if back up heater is abnormal (H70) then back up heater anti freeze control will not activate.

### 12.17.1 Zone Anti-Freeze Control

- If buffer tank selection is "NO" and Anti- Freeze function select "NO" from remote control, this control cannot activate.

Start condition:

- a) After [5] min from previous Zone pump off. **AND**
- b) Outdoor air temp  $< [3]^{\circ}\text{C}$  **OR** Outdoor sensor is abnormal. **AND**
- c) Zone water temperature  $< [6]^{\circ}\text{C}$  **OR** Zone Sensor Short or Open

Cancel condition:

- a) After water Zone pump ON [4] min **AND**
  - b) Outdoor air temp  $\geq [4]^{\circ}\text{C}$  **OR**
  - c) During  $-5^{\circ}\text{C} \leq \text{Outdoor air temp} < [4]^{\circ}\text{C}$  **OR**  
Zone water temperature sensor  $> [8]^{\circ}\text{C}$
  - d) During Outdoor air temp  $< [-5]^{\circ}\text{C}$   
Zone water temperature sensor  $> [20]^{\circ}\text{C}$
- \*However, Zone water temperature sensor is Open or Short, Condition C and D is ignored.

## 12.18 Solar Operation (Optional)

### 12.18.1 Solar Operation:

Solar function:

- This function allow user to control the solar pump to operate depend on the solar sensor reading compare to the tank installed. Solar pump will circulate the hot water energy store at solar panel to heat up the DHW Tank or Buffer Tank.

Solar Connection Diagram:

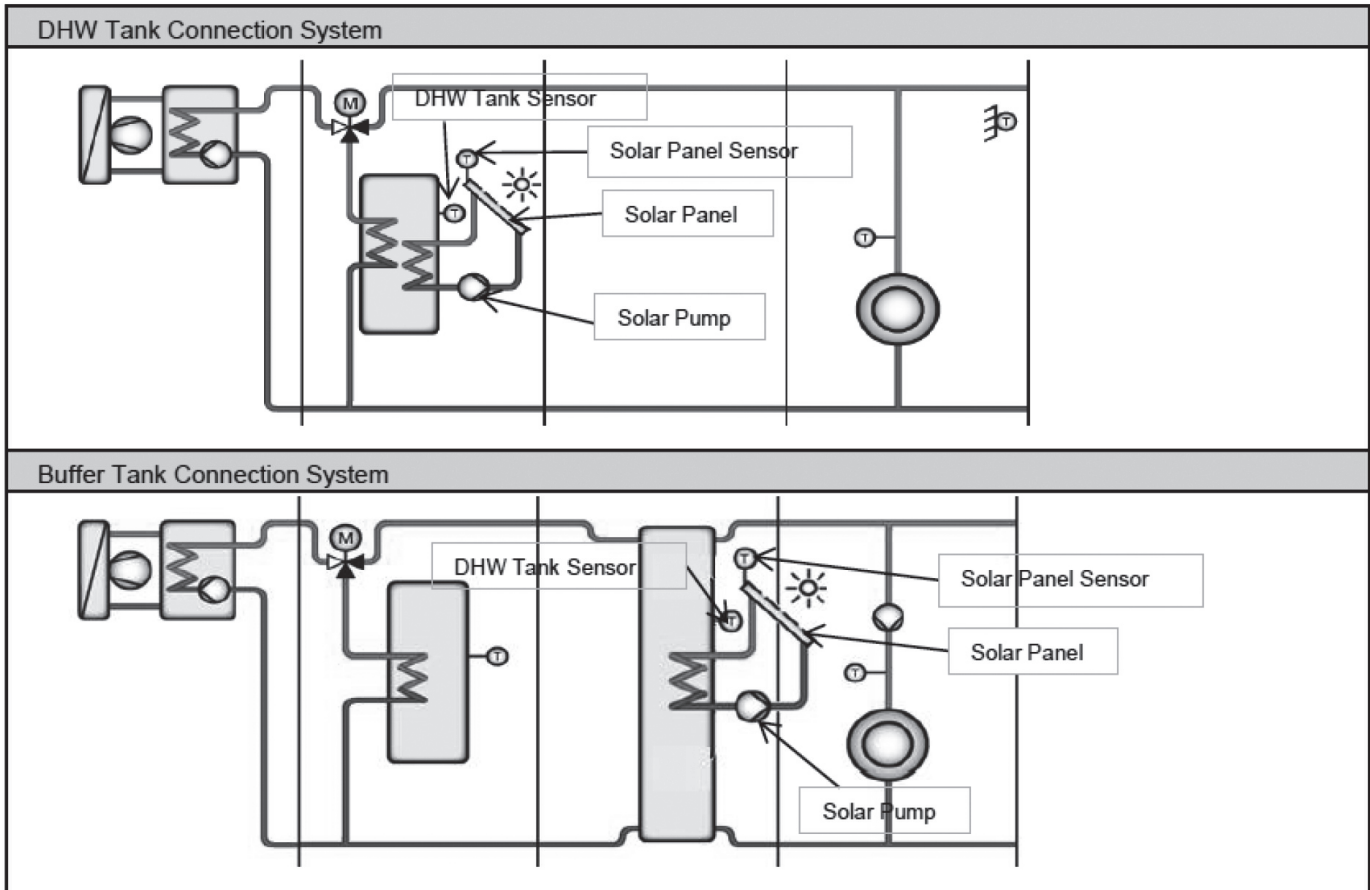

- Solar function can only enable when the Optional PCB is connected.
  - Few part as below need to install to control the solar operation:
    - Solar Panel
    - Solar Pump
    - Solar Panel Sensor
    - Tank Sensor (Buffer tank sensor **OR** DHW Tank sensor depend on the connection direction)
- \* During Solar Connection to the system, installer need to alert on the high water temperature may flow to the zone circuit or DHW piping circuit. Therefore pipe which withstand higher water temperature need to be installed.



### Solar remote control setting

- 1) Solar Setting can only be set when the optional PCB connection is select "YES"
- 2) By remote controller, Setting as below list can be set for solar function operation (Installer Menu)
  - Solar Function ("YES" or "NO")
  - Tank Connection Direction ("DHW TANK" or "BUFFER TANK")
  - Delta T turns ON: Difference temperature setting between solar panel sensor and Tank to turn on solar pump. (Range :5 ~ 15°C)
  - Delta T turns OFF: Difference temperature setting between solar panel thermistor and Tank to turn off solar pump. (Range :2 ~ 10°C)
  - Outdoor temp for Anti-Freeze : Outdoor temp to start Anti-Freeze control for solar circuit. (Range : -20 ~ 10°C)
  - Tank Temperature HI Limit Set (Range : 70 ~ 90°C)

### 12.18.2 Solar Operation Control

- Solar function can only be activate if the solar function selection "YES" from remote control. To achieve hot water from solar panel, indoor need to control the solar pump and circulate hot water from solar panel.

#### Under normal case:

- Solar pump start condition:
  - a) Solar panel temperature > Delta T turn on setting temp (R/C) + Tank temperature (depend on selection, DHW or Buffer) **AND**
  - b) Tank temperature (DHW or Buffer) < Solar HI Limit Temp (R/C) **AND**
  - c) Operation ON with heat mode (apply to solar connect to "Buffer Tank" case)

\* Condition c) ignore if the solar system is connect to DHW tank (control active under operation OFF time for Tank connection case)
- Solar pump stop condition:
  - a) Solar panel temperature < Delta T turn OFF setting temp (R/C) + Tank temperature (depend on selection, DHW or Buffer) **OR**
  - b) Tank hot water temp  $\geq$  Solar HI Limit Temp (R/C) + [2]°C

#### Under solar Anti-freeze protection control:

- Solar pump start condition:
  - a) Outdoor temp < Outdoor temp setting for Anti-Freeze (R/C)
- Solar pump stop condition:
  - a) Outdoor temp > Outdoor temp setting for Anti-Freeze + [2]°C

\*\*However, During Cool mode this function cannot activate if Tank selection is "Buffer Tank".

\*\*Solar pump can operate even if Heat pump is under error stop.

- Solar operation during error:
  - During Tank sensor (DHW or Buffer depend on selection) abnormal, Solar operation will not able to function.
  - During Solar Panel sensor detect OPEN (not include SHORT), Solar operation will not able to function too.

## 12.19 Boiler Bivalent Control

- Boiler is an additional or alternative heat source to heat up the room when necessary.
- Purpose of this control is to turn ON and turn OFF the Boiler output signal when boiler heating capacity needed in the system.
- Boiler is possible to connect to DHW Tank and Buffer Tank depends on the installer.
- Boiler operation parameter need to be set on Boiler itself, indoor do not control the boiler operation direction and operation.
- There are Alternative mode, Parallel mode, & Advance Parallel mode available to select by installer to fit to the total system.

### Bivalent control selection by remote controller

#### Remote control setting value:

- 1) Outdoor Ambient Set = (Range: -15°C ~ 15°C)

#### a) Alternative Mode

- Only one heat source operates at one time, either heat pump or boiler depends on condition.

#### Control detail:

During Operation ON at Heat mode or Tank mode or Heat + Tank Mode

- Boiler signal turn ON and heat pump and water pump turn OFF when:
  - a. Outdoor ambient < Outdoor Ambient Set **AND**
  - b. Boiler prohibit flag = 0

\*\* However indoor water pump can operate when Anti-freeze control condition fulfilled.

- Boiler signal turn OFF and heat pump and water pump turn ON when:
  - a. Outdoor ambient > Outdoor Ambient Set + [2°C] **OR**
  - b. Boiler prohibit flag = 1

#### b) Parallel Mode

- Parallel mode allows heat pump and boiler ON at the same time. Boiler operates as an additional heating capacity when low heat pump capacity at low ambient condition.

#### Control detail:

During operation ON at Heat mode or Tank mode or Heat + Tank mode

- Boiler signal turns ON when:
  - a. Outdoor ambient < Outdoor Ambient Set **AND**
  - b. Boiler prohibit flag = 0
- Boiler signal turns OFF when:
  - a. Outdoor ambient > Outdoor Ambient Set + [2°C] **OR**
  - b. Boiler prohibit flag = 1

#### c) Advance Parallel Mode

- Advance parallel mode allow heat pump to operate and turn ON boiler only when ambient and temperature condition is fulfilled.

#### Remote control setting value:

- 1) Outdoor Ambient Set = (Range : -15°C ~ 15°C)
- 2) Selection of boiler connection direction. (Heat only, DHW only, Heat & DHW)
- 3) Setting data under Heat Direction
  - a. Start Temperature | START\_TEMP |
  - b. Start Delay Timer | START\_TIMER |
  - c. Stop Temperature | STOP\_TEMP |
  - d. Stop Delay Timer | STOP\_TIMER |
- 4) Setting data under DHW Direction
  - a. Delay Timer | DELAY\_TIMER |

Control detail:

During operation ON at Heat Mode

- Boiler signal turns ON when
  - a. Outdoor ambient < Outdoor Ambient Set **AND**
  - b. Buffer tank temperature < Target Buffer Tank Temperature + [START\_TEMP] for [START\_TIMER] **AND**
  - c. Heat pump operate at room side **AND**
  - d. Connection of Boiler to Heating Select "YES" From installer menu **AND**
  - e. Buffer Tank connection select "YES" **AND**
  - f. Boiler prohibit flag = 0
- Boiler signal turns OFF when
  - a. Outdoor ambient > Outdoor Ambient Set + [-2°C] **OR**
  - b. Buffer Tank temperature > Target Buffer Tank temperature + [STOP\_TEMP] for [STOP\_TIMER] **OR**
  - c. Heat pump not at room side. **OR**
  - d. Boiler prohibit flag = 1

During operation ON at Tank Mode

- Boiler signal turns ON when
  - a. Outdoor ambient < Outdoor Ambient Set **AND**
  - b. Heat pump operate at tank side for continuous | DELAY\_TIMER | **AND**
  - c. Connection of Boiler to DWH Tank select "YES" from installer menu. **AND**
  - d. Boiler prohibit flag = 0
- Boiler signal turns OFF when
  - a. Outdoor ambient > Outdoor Ambient Set + [2°C] **OR**
  - b. Heat pump not operates at tank side. **OR**
  - c. Boiler prohibit flag = 1

**Boiler prohibit flag control**

Purpose:

- For product safety. Boiler signal is OFF when water temperature is too high.

Start condition:

- a. Water outlet  $\geq 85^{\circ}\text{C}$  continues for 5 minutes.
- b. Water inlet  $\geq 85^{\circ}\text{C}$  continues for 5 minutes.
- c. Zone1 water temp  $\geq 75^{\circ}\text{C}$  continues for 5 minutes.
- d. Zone2 water temp  $\geq 75^{\circ}\text{C}$  continues for 5 minutes.

Contents:

- After start condition fulfilled, set boiler prohibit flag = 1

Cancel condition:

- After 30 minutes from start condition fulfilled.

Contents:

- Set boiler prohibit flag = 0

## 12.20 External Room Thermostat Control (Optional)

Purpose:

- 1 Better room temperature control to fulfill different temperature request by external room thermostat.  
Recommended external room thermostat:

Maker	Characteristic
Siemen (REV200)	Touch panel
Siemen (RAA20)	Analog

Connection of external room thermostat:

Wire Connection and thermo characteristic of Siemen REV200:

Setting	L/L1 (H)	Heat Thermo	L/L2 (C)	Cool Thermo
Set Temp < Actual Temp	Open Circuit	OFF	Short Circuit	ON
Set Temp > Actual Temp	Short Circuit	ON	Open Circuit	OFF

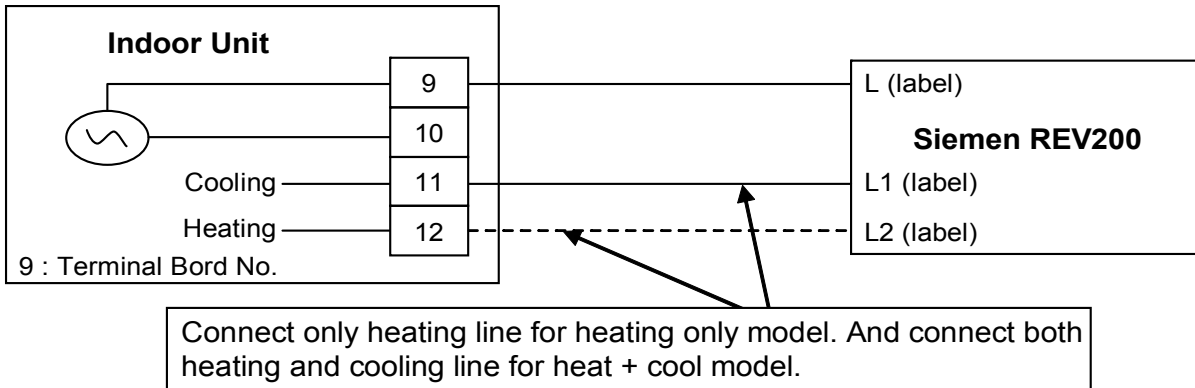

Wire Connection and thermo characteristic of Siemen RAA20:

Setting	L/Y1 (H)	Heat Thermo	L/Y2 (C)	Cool Thermo
Set Temp < Actual Temp	Open Circuit	OFF	Short Circuit	ON
Set Temp > Actual Temp	Short Circuit	ON	Open Circuit	OFF

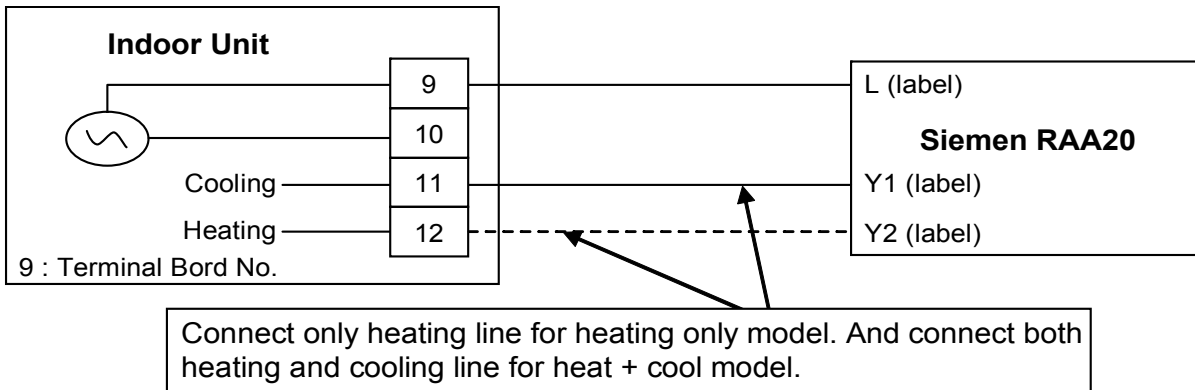

Control Content:

- External room thermostat control activate only when remote thermostat connection select YES by Indoor control panel.
- When indoor running heat mode, refer thermo On/Off from heating line feedback. And when indoor running cool mode, refer thermo On/Off from cooling line feedback.
- Heat pump Off immediately when receive thermo off feedback.

## 12.21 Three Ways Valve Control

Purpose:

- 3 ways valve is used to change flow direction of hot water from heat pump between heating side and tank side.

Control contents:

- 1 3 ways valve switch Off:
  - During 3 ways valve switch Off time, the hot water will provide heat capacity to heating side.
- 2 3 ways valve switch On:
  - During 3 ways valve switch On time, the hot water will provide heat capacity to tank side.
- 3 Stop condition:
  - During stop mode, 3 ways valve will be in switch off position.

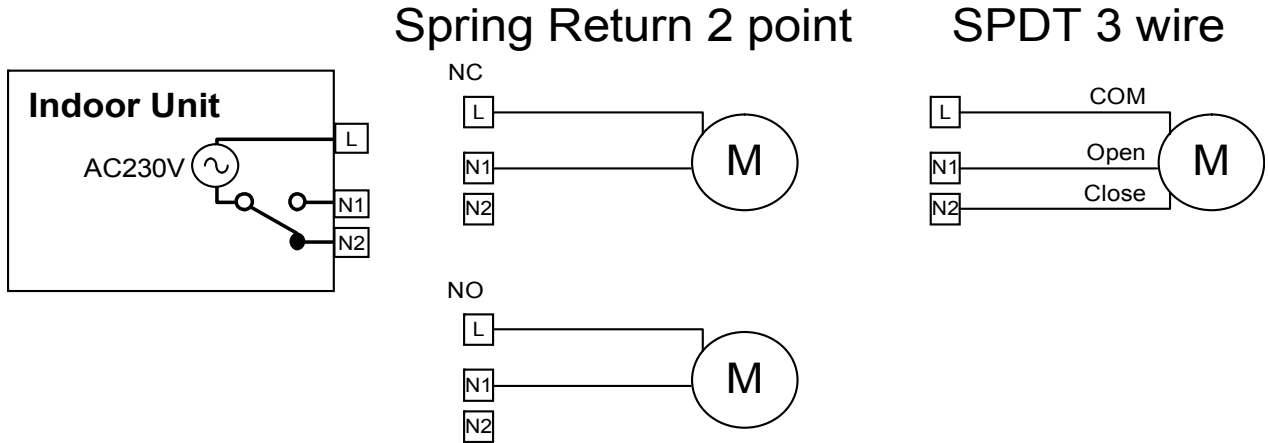

\* During pump down and force mode, fix 3 ways valve in close condition.

\* Recommended Parts : SFA 21/18 (Siemens)

## 12.22 Two Ways Valve Control

Functionality of 2 ways valve:

- Use to allow hot water to floor heating panel or block cold water to floor heating panel.

Control contents:

- 1 When indoor running in heat mode, OPEN the 2 ways valve.
- 2 When indoor running in cool mode, CLOSE the 2 ways valve.
- 3 Stop condition:

- a. During stop mode, fix 2 ways valve in close condition.

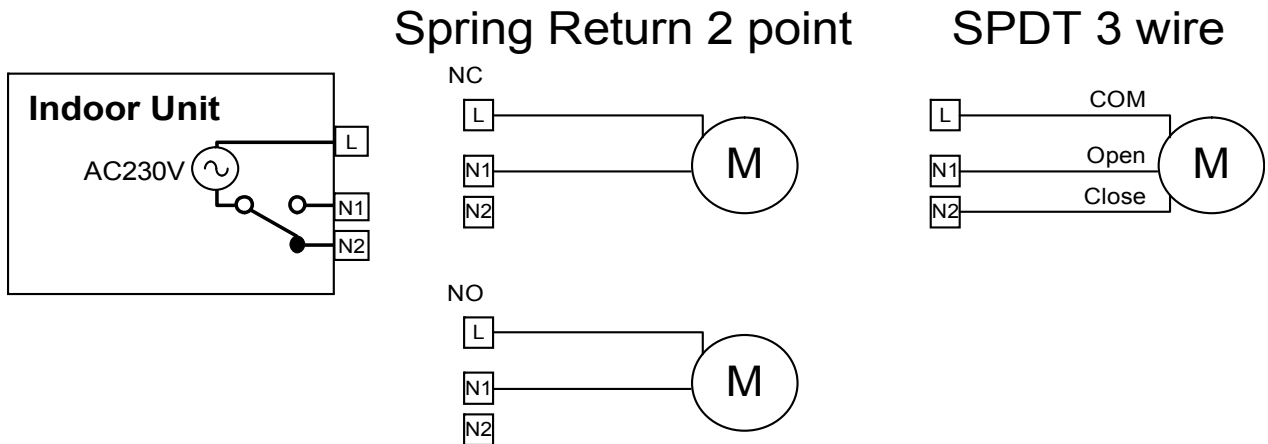

\* During pump down mode, fix 2 ways valve in close condition.

\* During force mode, open 2 ways valve.

\* Recommended Parts : SFA 21/18 (Siemens)

## 12.23 External OFF/ON Control

- Communication circuit between indoor unit and external controller is as per below.

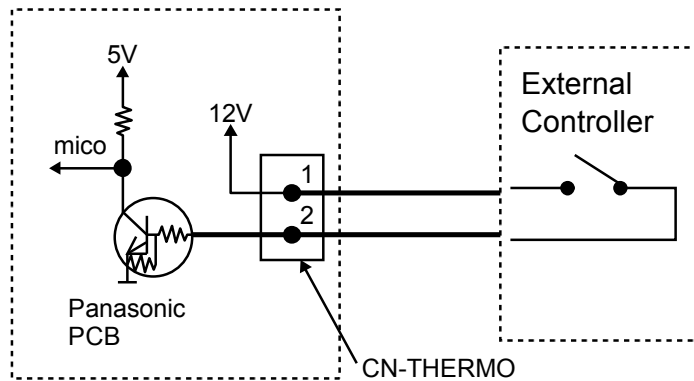

- Maximum length of communication cable is 50 meter.
- Control content:

External Control Switch	Control Panel OFF/ON	Control Panel Power LED	System Status
ON	ON	ON	ON
ON	OFF	OFF	OFF
OFF	ON	ON	OFF
OFF	OFF	OFF	OFF

### Remocon Screen Display and Control Detail:

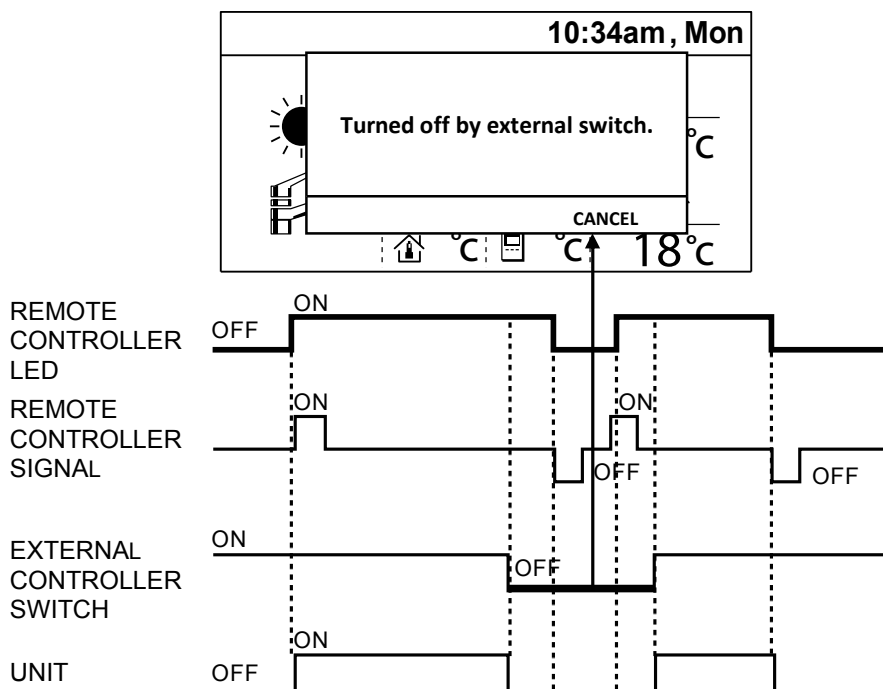

When External SW connection select "YES" from remocon installer menu:

- Heating or Cooling system will operate normally if the External Switch signal is ON.
- Once the External Switch turn OFF, System Turn OFF ( Heat pump, water pump, heater etc...)
- Remocon LED remain ON or OFF according to the current operation request.
- Pop up menu at remocon main screen as above screen to inform customer system stop by External Switch.
- It is possible to press cancel and return to main screen to do change of operation setting while waiting the External Switch turn ON back.
- Remocon LED will always follow the latest changes from remocon.
- If no action on remocon for continuous 5 minutes, the pop up screen will show again on the screen.
- But once the External Switch Turn ON back, pop up screen will dsappear and system can operate normally according to the latest operation setting and request.

## 12.24 External Compressor Switch (Optional PCB)

External compressor switch port can have two purpose of control as below:

- a) Heat source ON/OFF function (Dip switch Pin 3 on PCB "OFF")
- b) Heater ON/OFF function (Dip switch Pin 3 on PCB "ON")

a) Heat source ON/OFF function

Purpose:

- Heat pump ON/OFF function is use to turn OFF the high power consumption device (Heat pump, & Heater) when there is energy or electric current limitation. Other optional function still can be operate under heat pump and heater OFF condition.

Control Detail:

- This External Compressor Switch is possible to connect to Optional PCB only.
- Once the remocon select External Compressor Switch connection "YES", & Dip Switch on PCB "OFF" This heat pump ON/OFF function will activate
- The ON/OFF signal of this External Compressor Switch is same as External Switch.
- When the External Compressor Switch is ON:
  - a) Heat pump system operate normally
- When the External Compressor Switch is OFF:
  - a) Heat pump, Indoor water pump & Heater ( Booster heater & Backup Heater ) need to turn OFF
  - b) Solar, Boiler and zone control can be operate follow normal control condition.
    - \* pump delay OFF also included in this control

(There is NO pop up screen like External Switch when this External Compressor Switch is OFF.)

b) Heater ON/OFF function

Purpose:

- Heater ON/OFF function is use to turn OFF the heater (backup heater & booster heater) when there is energy or electric current limitation. Heat pump and other optional function still can operate.

Control detail:

- This External Compressor Switch is possible to connect to Optional PCB only.
- Once the remocon select External Compressor Switch connection "YES", & Dip Switch on PCB "ON" This heater ON/OFF function will activate
- When the External Compressor Switch is ON:
  - a) Heat pump and heater operate normally
- When the External Compressor Switch is OFF:
  - a) Backup heater and booster heater cannot operate even heater request is ON.
  - b) Heat pump and option function (Solar, Boiler and zone control) can be operate follow normal control condition.

(There is NO pop up screen like External Switch when this External Compressor Switch is OFF.)

## **12.25 Heat/Cool Switch (Optional PCB)**

### Purpose:

- User can switch the running mode from heat to cool or cool to heat through external installed Heat/Cool switch. This kind of heat / cool switch may built in inside the field supply room remocon as well.

### Control contents:

- Heat/Cool Switch can only be set when Cool Function is "enable" at custom menu setting, & Extension PCB select "YES" & Zone 1 not set "Pool" condition.
- This heat/cool switch control will be activate only when installer set the Heat/Cool Switch "USE" through remocon.
- Once the Heat/Cool Switch Set "USE", remocon will check indoor send Signal to judge the option of mode select.
  - a) When Heat/Cool Switch Contact Open : Remocon only can select Heat Mode, or Heat + Tank Mode, or Tank Mode
  - b) When Heat/Cool Switch Contact Close : Remocon only can select Cool Mode, or Cool + Tank Mode, or Tank Mode
- Operation ON/OFF will depend on remocon request.
- When Heat Mode is running with Contact Open, user change this setting to contact close, indoor will this signal to remocon judge and change mode to cool and send back to indoor. And it is same as from cool mode change to heat mode.
  - \* This switch have higher priority, remocon follow indoor send signal when control activated.
  - \* There is no effect to the operation when the mode running is only Tank Mode.

(Weekly Timer are ignored and cannot be set during Heat / Cool Switch is "Enable" Condition.)



## 12.26 SG Ready Control (Optional PCB)

Purpose:

- To set ON/OFF of heat pump and target temperature by digital input of third party device if necessary in field.

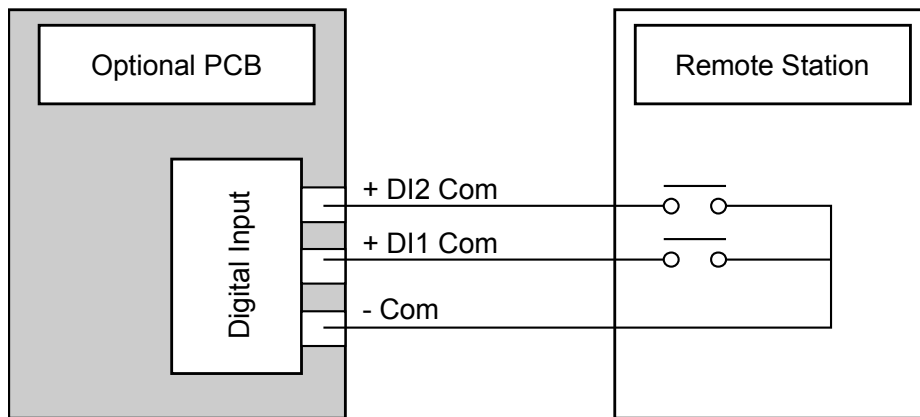

### Remote control setting

For this function, following items need to be set on R/C (installer menu) –

- SG control = YES or NO
- Capacity up setting 1
  - o Heating capacity [50 ~ 150 %]
  - o DHW capacity [50 ~ 150 %]
- Capacity up setting 2
  - o Heating capacity [50 ~ 150 %]
  - o DHW capacity [50 ~ 150 %]

### Control contents:

If SG control on remote control = "Yes", then following control only activate by digital input.

- **While Digital input is " 00 " (Normal operation)**
  - o Normal operation. Once detect '00' system will operate back to normal condition.  
(All the target set temperature for heating side and DHW side will return back to previous set temperature when digital signal change from "10" or "11" back to "00".)
- **While digital input is detected " 01 " (HP stop)**
  - o Heat pump & room heater & tank heater cannot operate.  
**(Solar control and Boiler back up and 2 Zone control can activate.)**
- **While digital input is detected " 10 " (Capacity 1)**
  - o Target temperature for heating and DHW Tank is changed according to the percentage set by Remote control setting. However, which setting temperature is change depend on system setting.
- **While digital input is detected " 11 " (Capacity 2)**
  - o Target temperature for heating and DHW Tank is changed according to the percentage set by Remote control setting. However, which setting temperature is change depend on system setting.

- **While digital input is detected " 10 " (Capacity 1)**
  - o Setting temperature for heating and Tank is changed.  
However, which setting temperature is change depend on system setting.

**If Buffer selection is "YES"**

Room side

New Target Buffer tank temperature = Current Target Buffer Tank Temperature \* Remote Control setting (" capacity 1) %

\* Max Min regulation is follow Target Buffer tank temperature control specification

\*\* No change of Target zone water temperature, only set higher buffer tank temperature.

DHW Tank side

New Tank Set Temperature = Tank Set Temperature \* Remote Control setting for DHW ("Capacity 1) % \*  
(Max regulation depend on the tank max setting limit)

**If Buffer selection is "NO"**

Room side

New Target Zone Water Temperature = Current Target Zone Water Temperature \* Remote Control Setting (\*Capacity 1) %

(Zone 1 and Zone 2 will change according to its own target zone water temperature.)

(Max regulation depend on the temperature control type select)

DHW Tank side

New Tank Set Temperature = Tank Set Temperature \* Remote Control setting for DHW ("Capacity 1) %  
\* (Max regulation depends on the tank max setting limit)

- **While digital input is detected " 11 " (Capacity 2)**
  - o Setting temperature for heating and Tank is changed.  
However, which setting temperature is change depend on system setting.

**If Buffer selection is "YES"**

Room side

New Target Buffer tank temperature = Current Target Buffer Tank Temperature \* Remote Control setting (" capacity 2) %

\* Max Min regulation is follow Target Buffer tank temperature control specification

\*\* No change of Target zone water temperature, only set higher buffer tank temperature.

DHW Tank side

New Tank Set Temperature = Tank Set Temperature \* Remote Control setting for DHW ("Capacity 2) %  
\* (Max regulation depends on the tank max setting limit)

**If Buffer selection is "NO"**

Room side

New Target Zone Water Temperature = Current Target Zone Water Temperature \* Remote Control Setting (\*Capacity 2) %

(Zone 1 and Zone 2 will change according to it's own target zone water temperature.)

(Max regulation depend on the temperature control type select)

DHW Tank side

New Tank Set Temperature = Tank Set Temperature \* Remote Control setting for DHW ("Capacity 2) %  
\* (Max regulation depends on the tank max setting limit)

\*\* This function is not applicable for Cooling mode.

## **12.27 Demand Control (Optional PCB)**

Remote control setting:

- When Optional PCB connection select 'YES', Demand Control function can select "YES" or "NO".

Purpose:

- After the demand control select YES, below control will activated.
  - o 0-10V Demand control

0-10V Demand control

- Demand control is use to reduce the current usage of heat pump unit by third party device.

Control start condition:

- o Select "YES" at Demand control at installer menu.
- o 0-10V input for this electrical current control is detected.

Control content:

- o If start condition is fulfilled, indoor will receive the voltage signal from optional PCB. Indoor will send the rate value to outdoor unit.
- o Outdoor will change the current limit according to the percentage receive from indoor unit.

## 12.28 Holiday Mode

- Purpose: Promotes energy saving by allowing the user to stop the system during holiday and enables the system to resume at the preset temperature after holiday.
- Control details:
  - Indoor operate the unit according running mode request. Target temperature will follow holiday setting temperature.
    - If heat mode request is receive, Target Water Out Temperature will change according to holiday shift temperature set.  
[If heat is set OFF at holiday, unit, water pump and zone control will OFF]
    - If tank mode request is receive, Target Tank Set Temperature will change according to the holiday tank shift temperature set.  
[If tank is set OFF at holiday, heat pump and tank heater will OFF]
  - After days of holiday have been set, heat pump will stop and only resume operation at the end of holiday countdown.
- Start condition:
  - Holiday timer set and the holiday timer start
    - \* The day holiday mode was set is counted as day 1.
- Stop condition:
  - OFF/ON button is pressed.
  - Holiday timer is reached.

## 12.29 Dry Concrete

- Purpose: Provide heat to floor heating panel and dry the wet concrete during installation.
- Setting condition:
  - Dry concrete parameter can be set through remote control under system setup.
  - Parameters are possible to set up to 99 days with different target set temperature
- Control details:
  - Dry concrete mode will be activates when select ON from service setup.
  - Once start dry concrete function, remote control will send step 1 setting temperature to indoor unit.  
\* This temperature is set at zone temperature. If system is 2 zones, both zone target temperature is set as same temperature.
  - Heat pump will start heat mode operation to room side with received target water outlet temperature.  
\* Heat pump will operate according to Heat pump Target Water Temperature.
  - After complete day 1 setup operation, day 2 data will be send to indoor at 12.00am on the second day.
  - Each preset data will be send every day until dry concrete mode is complete, unit will turns OFF and exit dry concrete function.
  - 3 ways valve and booster heater will turn OFF and 2 ways valve will turns ON.
- Cancel condition:
  - Dry concrete mode is complete and OFF signal is received.
  - OFF signal is received by pressing OFF/ON button.

## 12.30 Flow Sensor

- The water flow sensor serves as an overload protector that shuts down the unit when the water level is detected to be low.
- Abnormal flow detection:

Sequence	Abnormal flow	Normal flow
Normal case	Flow rate < 11 l/min or ≥ 69 l/min	≥ 11 l/min
During status 2~6 on Anti-freeze deice	Flow rate ≥ 11 l/min	< 11 l/min

# 13. Protection Control

## 13.1 Protection Control for All Operations

### 13.1.1 Time Delay Safety Control

- 1 The compressor will not start for three minutes after stop of operation.

### 13.1.2 30 Seconds Forced Operation

- 1 Once the compressor starts operation, it will not stop its operation for 30 seconds.
- 2 However, it can be stopped using control panel at indoor unit.

### 13.1.3 Total Running Current Control

- 1 When the outdoor running current exceeds X value, the compressor frequency will decrease.
- 2 If the outdoor running current does not exceed X value, the compressor frequency will return to normal operating frequency.
- 3 If the outdoor running current continue to increase till exceed Y value, compressor will stop, and if this occurs 3 times within 20 minutes, system will stop operation and OFF/ON control panel LED will blink (F16 error occurs).

Operation Mode	UX09HE5		UX12HE5	
	X (A)	Y (A)	X (A)	Y (A)
Heating	24.1	30.0	28.1	30.0
Cooling	16.4	30.0	18.1	30.0

#### A. DC Peak Current Control

- 1 When the current to IPM exceeds set value of 34 A, compressor will stop. Compressor will restart after three minutes.
- 2 If the set value exceeds again for more than 30 seconds after the compressor restarts, operation will restart after two minutes.
- 3 If the set value exceeds again for within 30 seconds after the compressor restarts, operation will restart after one minute. If this condition repeats continuously for seven times, system will stop operation and OFF/ON control panel LED will blink (F23 error occurs).

### 13.1.4 Compressor Overheating Prevention Control

- The compressor operating frequency is regulated in accordance to compressor tank temperature as shown in below figures. When the compressor tank temperature exceeds 107°C, compressor will stop, and if this occurs 4 times within 30 minutes, system will stop operation and OFF/ON control panel LED will blink (F20 error occurs).

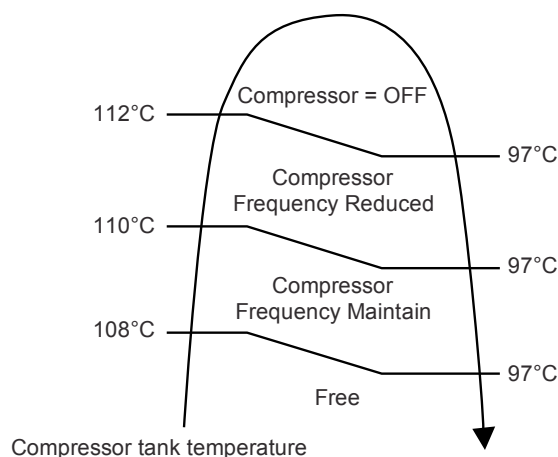

### 13.1.5 High Pressure Sensor Control

- Purpose:
  - To protect the system operation.
- Detection period:
  - After compressor on for 1 minute.
- Detection conditions:
  - When abnormal high voltage detection, 5 V or when open circuit detection 0V for 5 seconds continuously.
- After detection:
  - When abnormality is detected 4 times within 120 minutes, unit stop operation.
  - OFF/ON control panel LED will blink (H64 error occurs).

### 13.1.6 Outside Temperature Current Control

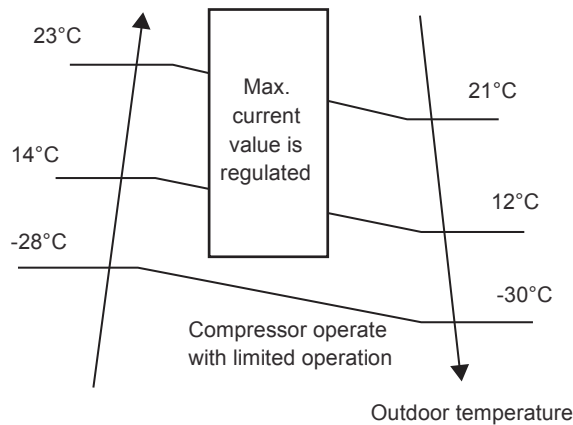

### 13.1.7 Crank Case Heater Control

- Purpose:
  - For compressor protection during low outdoor ambient operation (during heating low temperature operation).
- Control content:
  - a. Trigger heater START condition
    - When the outdoor air temperature is below than 5°C, and discharge temperature is 11°C or below.
  - b. Resetting heater STOP condition
    1. When the outdoor air temperature exceeds entry condition (2°C)
    2. When the discharge temperature exceeds entry condition (5°C)

### 13.1.8 Compressor Cold Start Prohibition Control

- Purpose:
  - Protect compressor when poor compressor oil return at low outdoor ambient and high water temperature condition.
- Control content:
  - Do not run compressor when below condition fulfilled
    - a. Compressor top temperature < 10°C
    - b. Outdoor ambient < -20°C
    - c. Water temperature > 40°C

## 13.2 Protection Control for Heating Operation

### 13.2.1 Outdoor Air Temperature Control

The maximum current value is regulated when the outdoor air temperature rises above 14°C in order to avoid compressor overloading.

### 13.2.2 Deice Operation

When outdoor pipe temperature and outdoor air temperature is low, deice operation start where outdoor fan motor stop.

- Deice judging condition

Outdoor Unit Deice Control

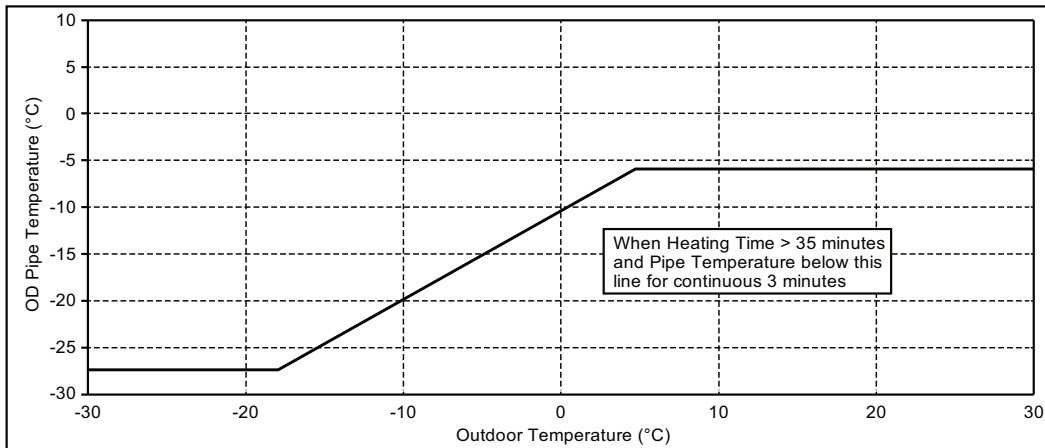

**Deice start depends:**

1. Outdoor air sensor temp.
2. Outdoor pipe sensor temp.
3. Heating accumulation time

- Deice mode selection condition
  - There are 2 deice modes, according to water inlet temperature and outdoor ambient temperature the deice mode is decided.

Water inlet temperature

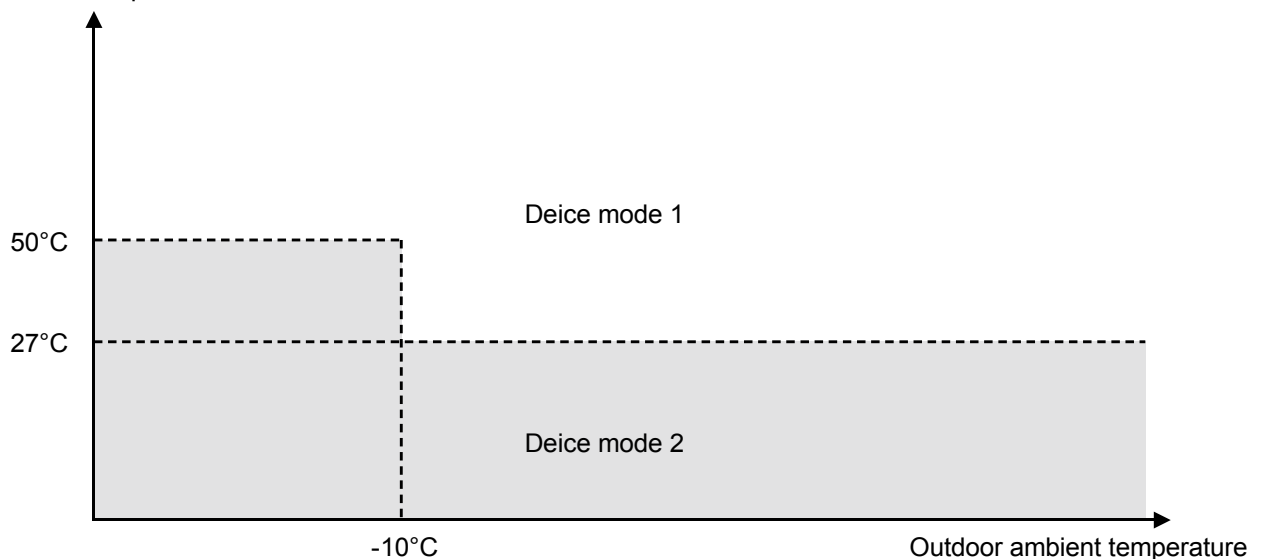

Judgement details:

- 1) When water inlet temperature is more than 50°C, unit will operate deice mode 1.
- 2) When water inlet temperature is less than 27°C, unit will operate deice mode 2.
- 3) When water inlet temperature is less than 50°C and outdoor ambient temperature is less than -10°C, unit will operate deice mode 2.
- 4) When water outlet temperature sensor 2 detect temperature is less than 22°C, unit will operate deice mode 2.

- Deice operation time diagram

a. Deice mode 1 control:

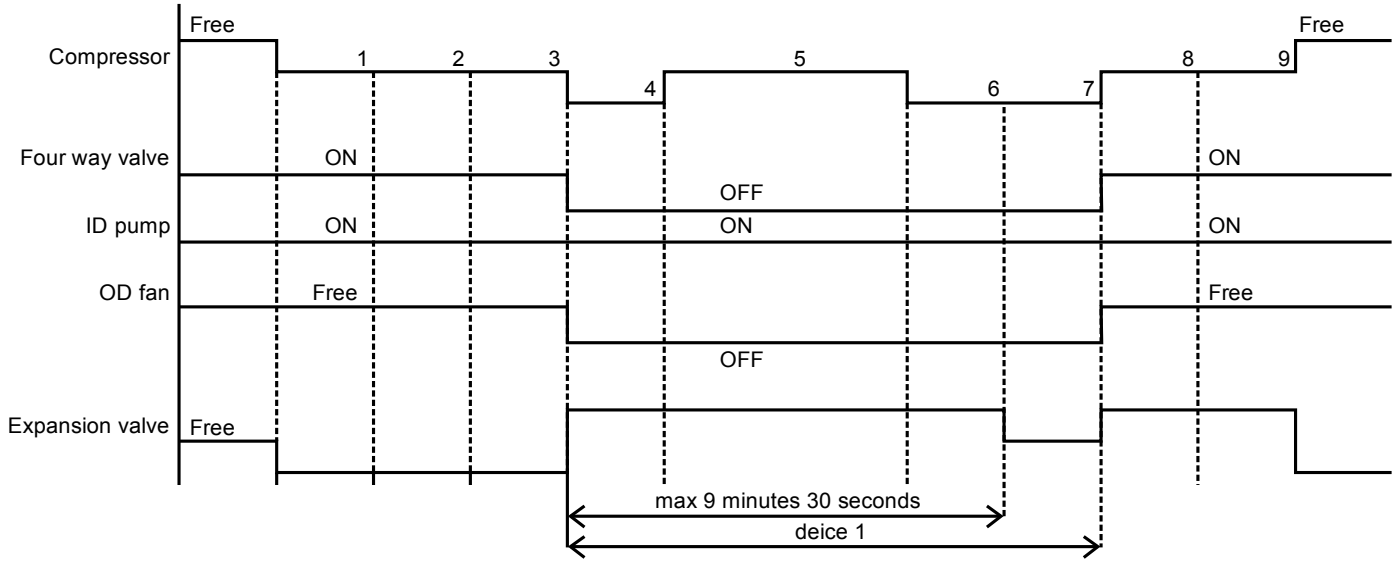

b. Deice mode 2 control:

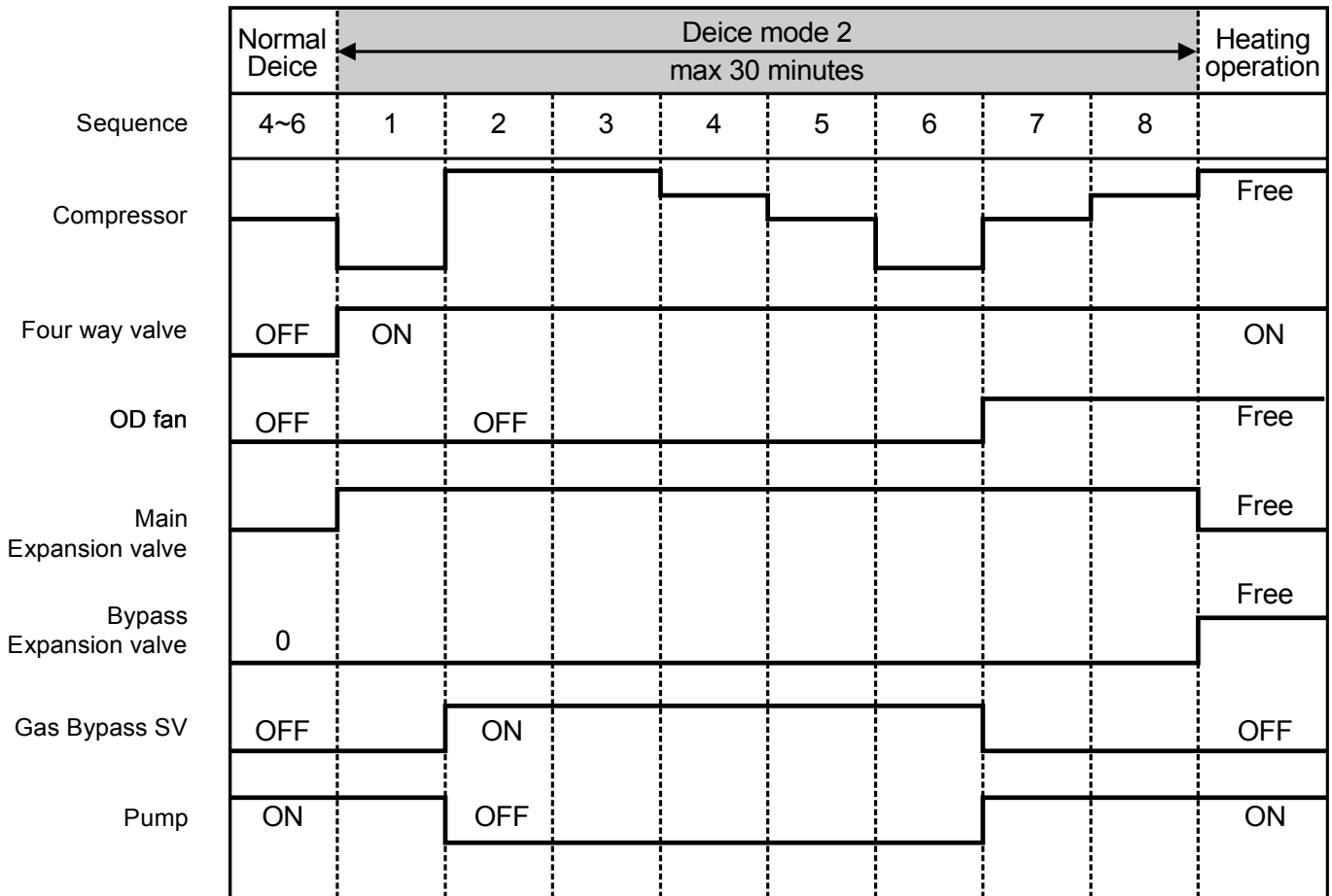



### 13.3 Protection Control for Cooling Operation

#### 13.3.1 Outdoor Air Temperature Control

- The Compressor operating frequency is regulated in accordance to the outdoor air temperature as shown in the diagram below.
- This control will begin 1 minute after the compressor starts.
- Compressor frequency will adjust base on outdoor air temperature.

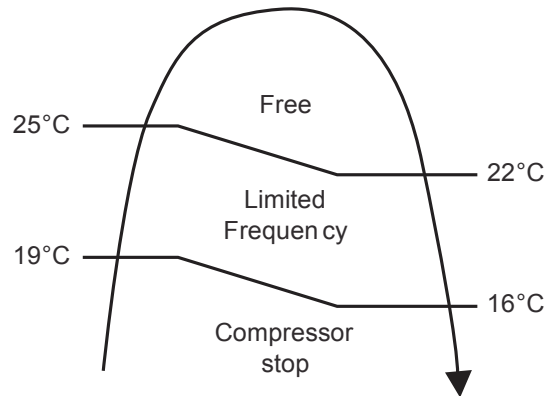

#### 13.3.2 Freeze Prevention Control 1

- 1 When indoor heat exchanger temperature is lower than 0°C continuously for 10 seconds, compressor will stop operating.
- 2 Compressor will resume its operation three minutes after the indoor heat exchanger is higher than 1°C.
- 3 Indoor heat exchanger freeze prevention (H99) will memory in error history.

## 14. Servicing Mode

### 14.1 How to Take Out Front Plate

Please follow the steps below for take out front plate. Before removing the front plate of indoor unit, always switch off all power supply (i.e. indoor unit power supply, heater power supply and Tank Unit power supply).

- 1 Remove the 2 mounting screws which located at bottom of the front plate.
- 2 Gently pull the lower section of the front plate towards you to remove the front plate from left and right hooks.
- 3 Hold the left edge and right edge of front plate to lift up front plate from hooks.

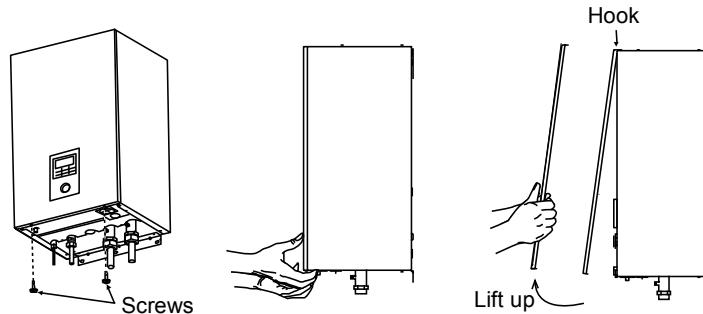

### 14.2 Test Run

- 1 Fill up the Tank Unit with water. For details refer to Tank Unit installation instruction and operation instruction.
- 2 Set ON to the Indoor Unit and RCCB/ELCB. Then, for control panel operation please refers to air-to-water heatpump operation instruction.
- 3 For normal operation, pressure gauge reading should be in between 0.05 MPa and 0.3 MPa.
- 4 After test run, please clean the Water Filter Set. Reinstall it after finish cleaning.

### 14.3 Expansion Vessel Pre Pressure Checking

[Lower limit water volume of the system]

Please ensure the capacity of the circulating water of the total system including the capacity of the indoor unit is more than 30 L.

If the water capacity is insufficient, during deice operation, the water temperature is lowered and the water will freeze in the system's component leading to product failure.

[Upper limit water volume of the system]

The indoor unit has a build-in Expansion Vessel with 10 L air capacity and initial pressure of 1 bar.

Total amount of water in the system should be below 260 L. If the total amount of water is more than 260 L, please add expansion vessel (field supply). The expansion vessel capacity required for the system can be calculated from the formula below.

$$V = \frac{\varepsilon \times V_0}{1 - \frac{98 + P_1}{98 + P_2}}$$

V : Required gas volume

<expansion vessel volume L>

V<sub>0</sub> : System total water volume <L>

ε : Water expansion rate 5 → 60°C = 0.0171

P<sub>1</sub> : Expansion tank filling pressure = (100) kPa

P<sub>2</sub> : System maximum pressure = 300 kPa

- ( ) Please confirm at actual place

- The gas volume of the sealed type expansion vessel is presented by <V>.

- It's advised to add 10% margin for required gas volume of calculation.

Water expansion rate table

Water temperature (°C)	Water expansion rate ε
10	0.0003
20	0.0019
30	0.0044
40	0.0078
50	0.0121
60	0.0171
70	0.0228
80	0.0291
90	0.0360

[Adjustment of the initial pressure of the expansion vessel when there is a difference in installation height]  
If the height difference between the indoor unit and the highest point of the system water circuit (H) is more than 7m, please adjust the initial pressure of the expansion vessel (P<sub>g</sub>) according to the following formula.

$$P_g = (H \times 10 + 30) \text{ kPa}$$

# 14.4 Pump Down Procedures

Refer below steps for proper pump down procedure.

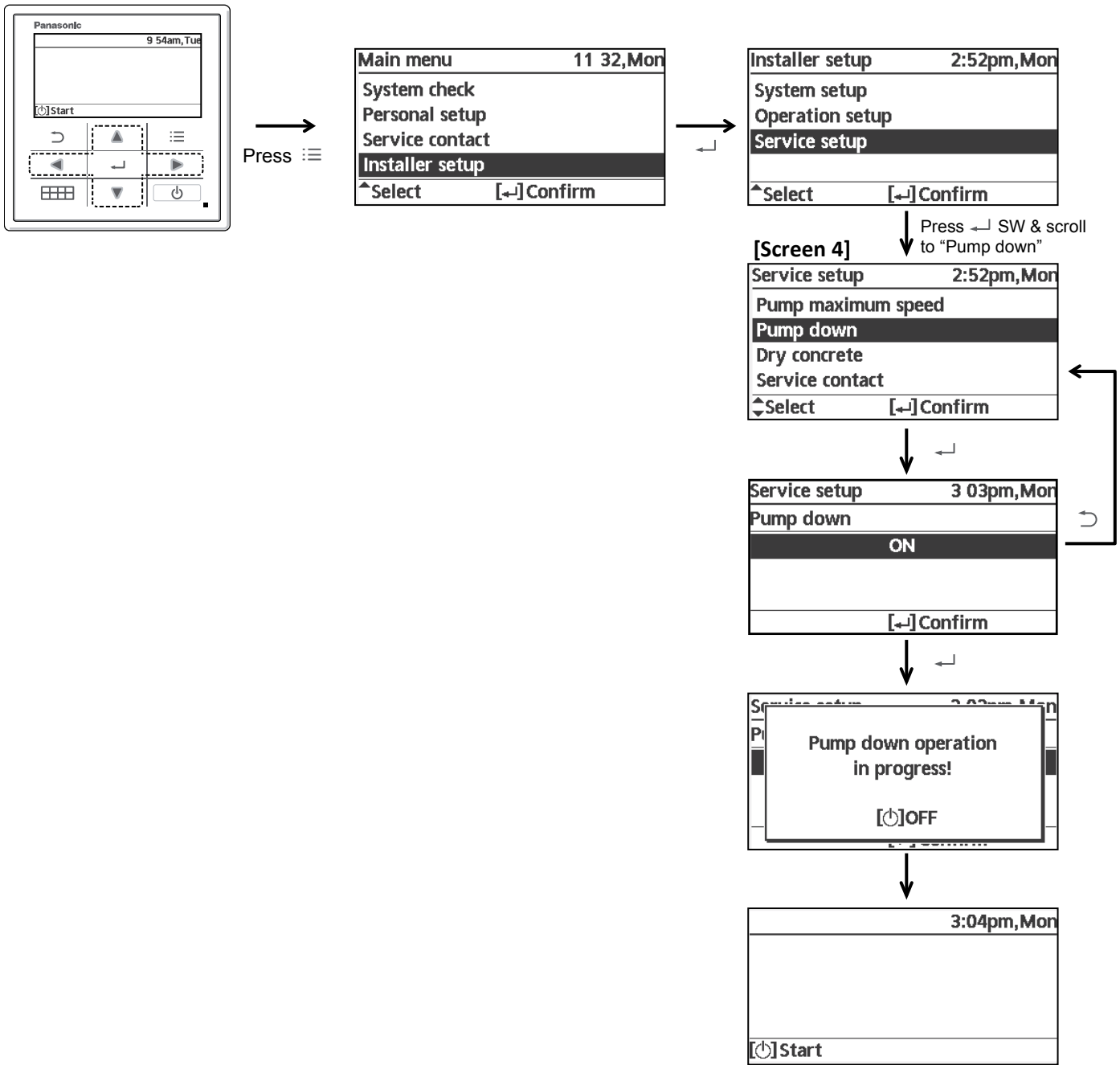

## 14.5 How To Adjust Pump Speed

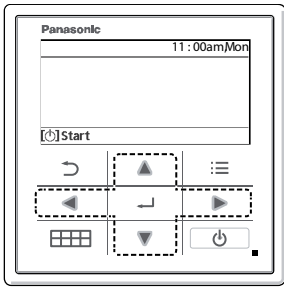

Press & scroll to "Installer setup"

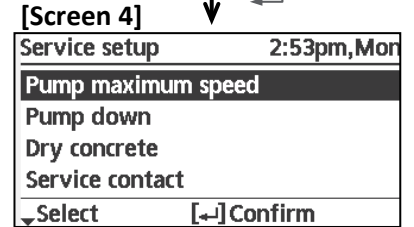
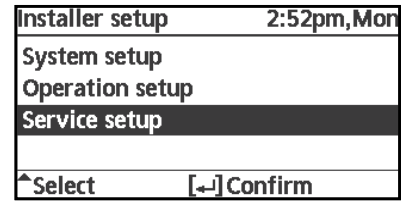
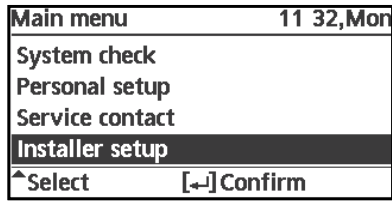

- Press or SW to select & confirm maximum duty. (Range: 0x40~0xFF)

[Screen 5]

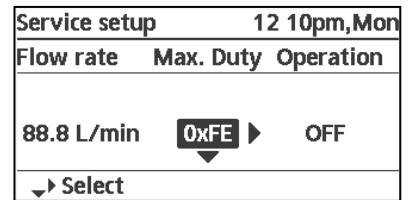
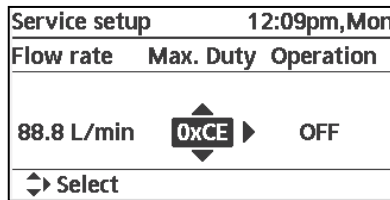
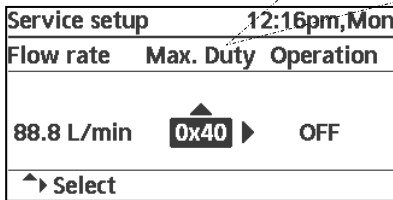

- Range (0.1~99.9)L/min

[Screen 6]

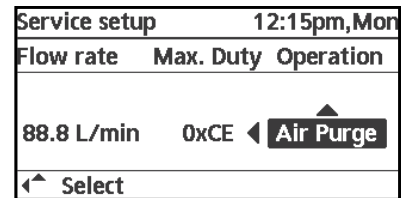
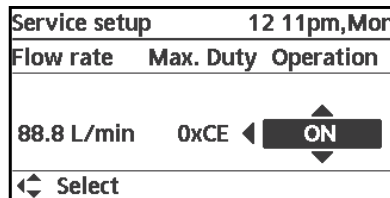
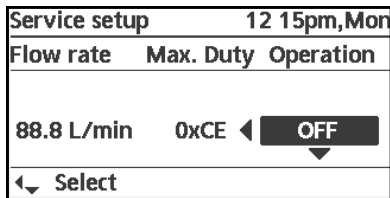

Press or SW to select & confirm operation

## 14.6 How To Adjust Pump Speed

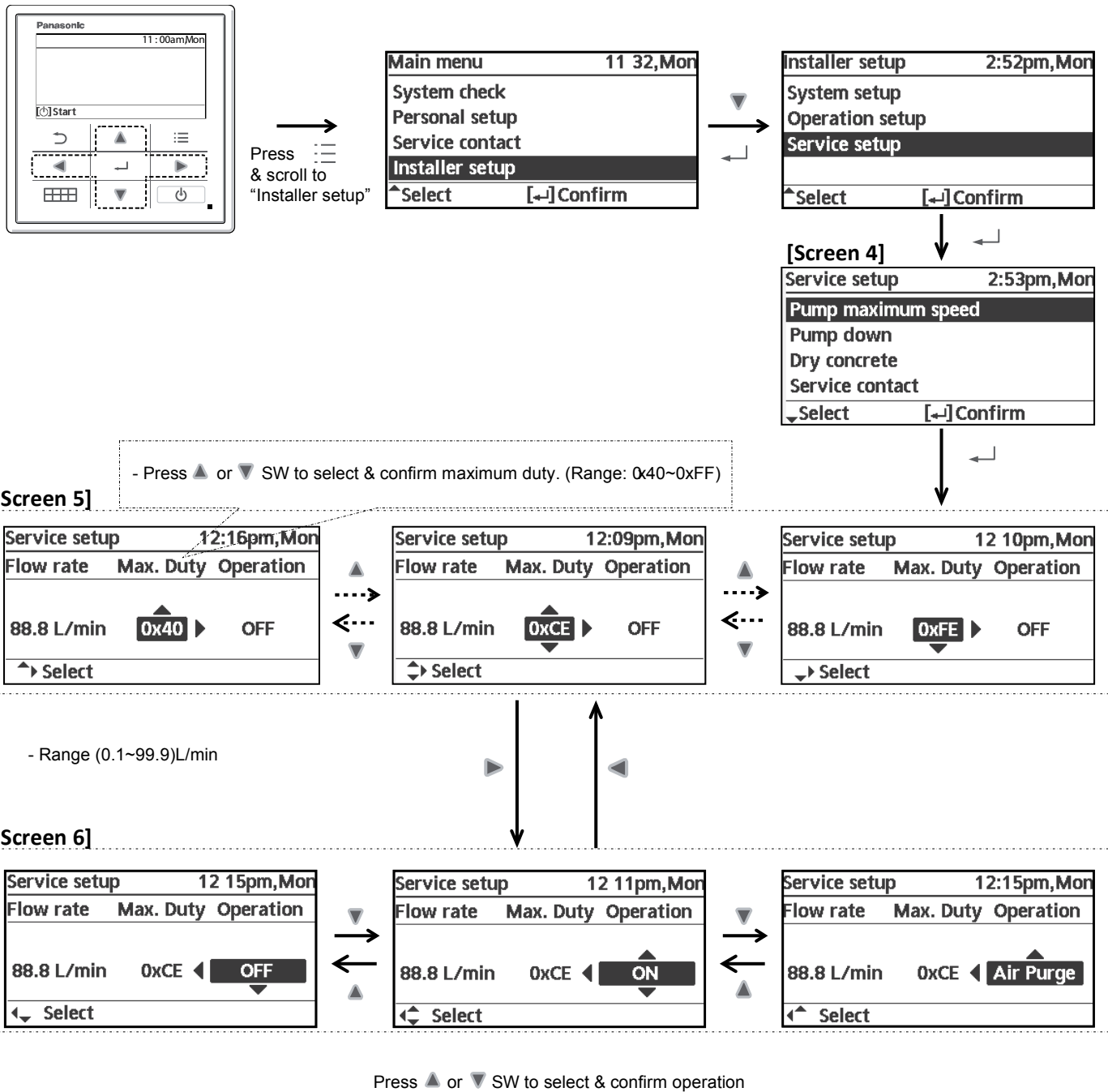

### NOTE:

1. Whenever at [Screen 5], if press SW to OFF, pump operation should be turned OFF.
2. Whenever at [Screen 6], if press SW to OFF, pump operation should be turned OFF.

## 14.7 How To Unlock Cool Mode

Operation must be OFF

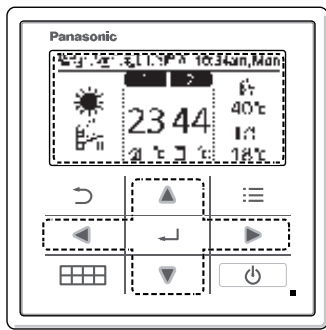

Press (☰ + ▼ + ◀) SW's continuously for 5secs

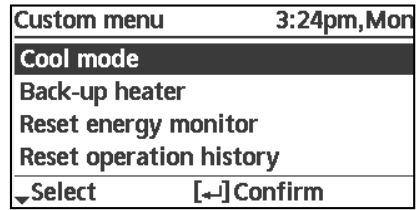
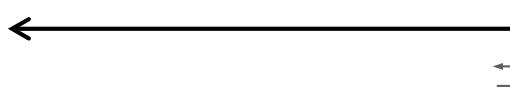

Display latest status retrieved from EEPROM

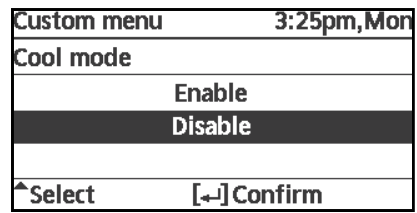
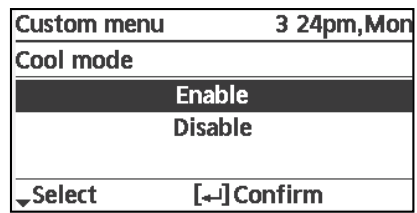

## 14.8 EEPROM Factory Default Data Setup Procedure

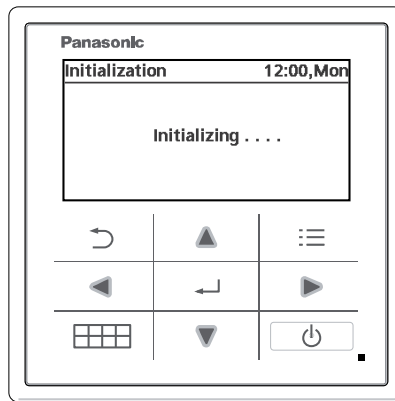

- EEPROM default data setup is only possible during initialization process.
- Press ( ▲, ▼, ◀, ▶)simultaneously for 5secs continuously, initialization process will stop & EEPROM default data setup process will start.

During EEPROM default data setup process, display should be as shown below.

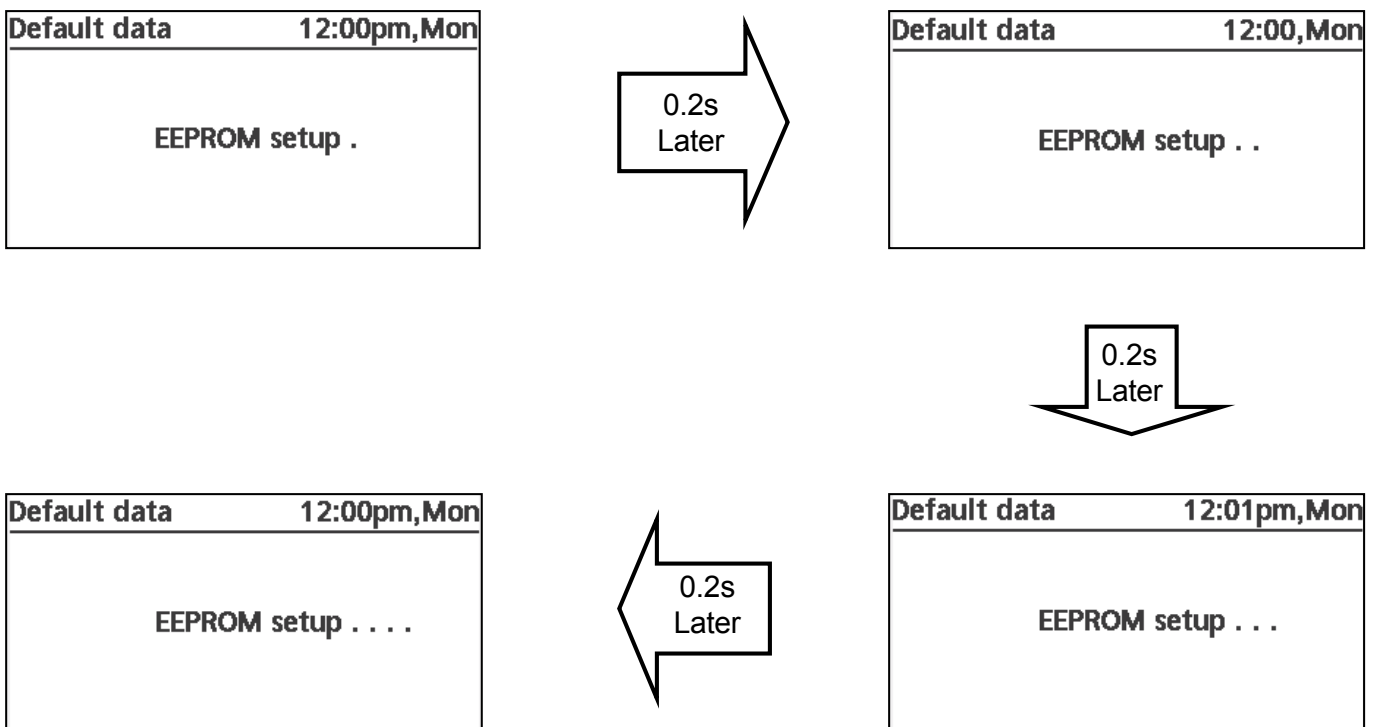

- Once EEPROM default data setup process is complete, initialization process will re-start from beginning.

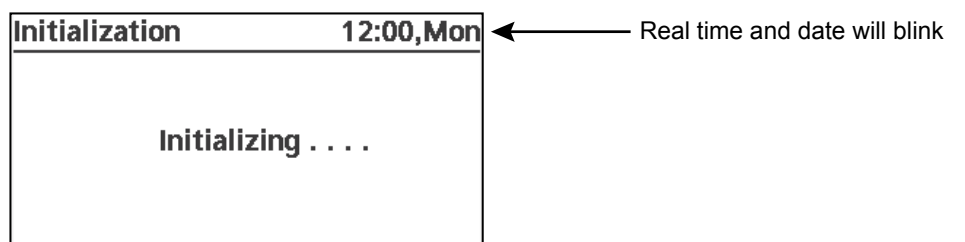

# 14.9 Dry Concrete Setup

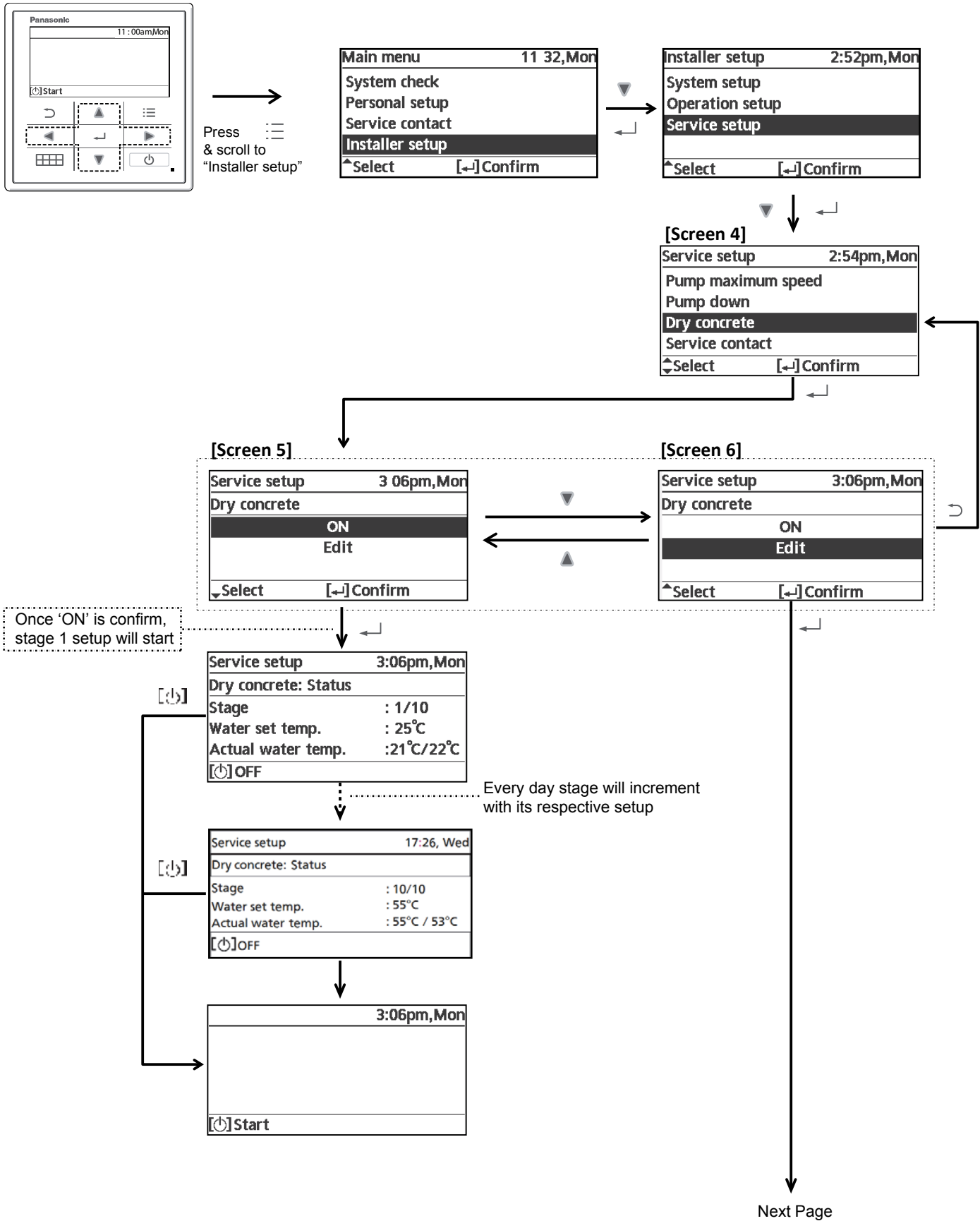



- Press ▲ or ▼ button to select no. of stages.  
 - Press ↵ to store latest status.  
 - Press ⏪ button, display will return to [Screen 6].

- If suppose to select 10 stages, then setup will start from stage 1/10.  
 - Press ▲ or ▼ button to select set temperature.  
 - Press ↵ button to store latest status.

- Move to next stage 2/10  
 - Repeat the same procedure

- Move to next stage 10/10  
 - Repeat the same procedure.  
 - Press ↵ to store latest status the the display will return to [Screen 4]  
 - Press ⏪ button to return to stage 9/10.

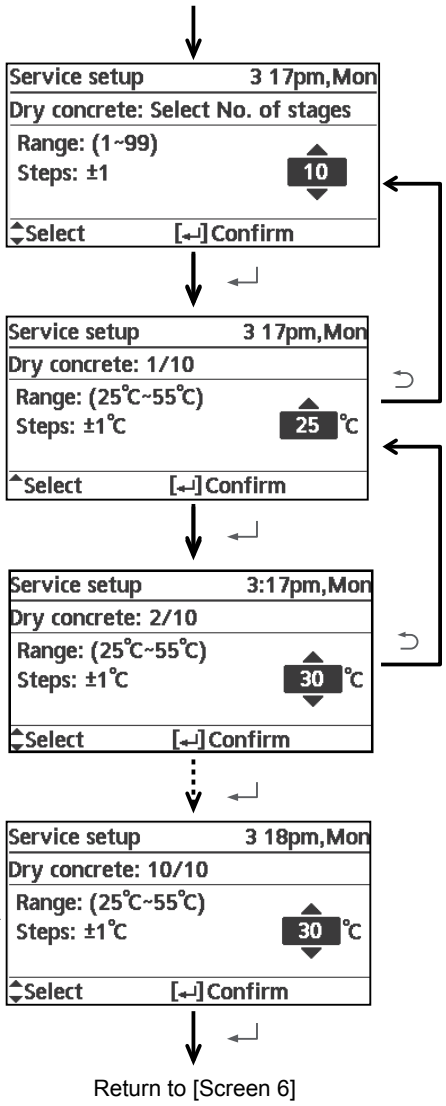

## 15. Maintenance Guide

In order to ensure safety and optimal performance of the unit, seasonal inspections on the unit, functional check of RCCB/ELCB, field wiring and piping have to be carried out at regular intervals. This maintenance should be carried out by authorized dealer. Contact dealer for scheduled inspection.

### 1 Water pressure

Water pressure should not lower than 0.05 MPa (with inspects the Water Pressure Gauge). If necessary add tap water into Tank Unit. Refer to Tank unit installation instruction for details on how to add water.

### 2 Pressure relief valve

- Check for correct operation of Pressure Relief Valve by turning on the lever to become horizontal.
- If you do not hear a clacking sound (due to water drainage), contact your local authorized dealer.
- Push down the lever after finish checking.
- In case the water keeps drained out from the unit, switch off the system, and then contact your local authorized dealer.

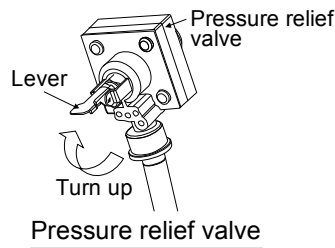

### 3 Air purge valve

Air purge valve must be installed at all high points in a closed water circuit system.

An automatic air purge valve is provided inside the indoor unit. To automatically purge the air from the system, turn the plug on the air outlet anticlockwise by one complete turn from fully closed position.

Excessive air is automatically purged if the plug is kept in this position.

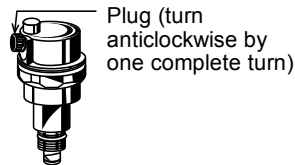

### 4 Indoor unit control board area

Thorough visual inspection of the control board and look for defects, i.e. loose connection, melting of wire insulator and etc.

### 5 Check RCCB/ELCB

Ensure the RCCB/ELCB set to "ON" condition before check RCCB/ELCB.

Turn on the power supply to the Indoor Unit.

This testing could only be done when power is supplied to the Indoor Unit.



Be careful not to touch parts other than RCCB/ELCB test button when the power is supplied to Indoor Unit. Else, electrical shock may happen. Before obtaining access to terminals, all supply circuits must be disconnected.

- Push the "TEST" button on the RCCB/ELCB. The lever would turn down and indicate "0", if it functions normal.
- Contact authorized dealer if the RCCB/ELCB malfunction.
- Turn off the power supply to the Indoor Unit.
- If RCCB/ELCB functions normal, set the lever to "ON" again after testing finish.

## 6 Reset overload protector

Overload Protector serves the safety purpose to prevent the water over heating. When the Overload Protector trips at high water temperature, take below steps to reset it.

- a. Take out the cover.
- b. Use a test pen to push the centre button gently in order to reset the Overload Protector.
- c. Fix the cover to the original fixing condition.

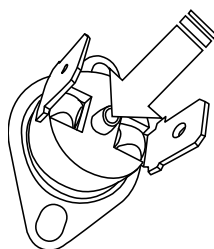

Use test pen to push this button for reset Overload protector.

## 15.1 Maintenance for Water Filter Set

### 15.1.1 Service and maintenance

#### When connect CN-CNT connector with computer

Please use optional USB cable to connect with CN-CNT connector.  
After connected, it requests for driver. If PC is under Windows Vista or later version, it automatically installs the driver under internet environment.

If PC uses Windows XP or earlier version and there is no internet access, please get FTDI Ltd's USB - RS232C conversion IC driver (VCP driver) and install.  
<http://www.ftdichip.com/Drivers/VCP.htm>

#### If forget Password and cannot operate remote controller

Press  $\leftarrow + \leftarrow + \rightarrow$  for 5 sec.  
Password unlock screen appears, press Confirm and it shall reset.  
Password will become 0000. Please reset it again.  
(CAUTION) Only display when it is locked by password.

### 15.1.2 Maintenance menu

#### Setting method of Maintenance menu

Maintenance menu	17:26, Wed
<b>Actuator check</b>	
Test mode	
Sensor setup	
Reset password	
▼ Select	[←] Confirm

Press  $\leftarrow + \leftarrow + \rightarrow$  for 5 sec.

Items that can be set



- ① Actuator check (Manual ON/OFF all functional parts)  
(CAUTION) As there is no protection action, please be careful not to cause any error when operating each part (do not turn on pump when there is no water etc.)
- ② Test mode (Test run)  
Normally it is not used.
- ③ Sensor setup (offset gap of detected temp of each sensor within  $-2\sim 2^{\circ}\text{C}$  range)  
(CAUTION) Please use only when sensor is deviated.  
It affects temperature control.
- ④ Reset password (Reset password)

### 15.1.3 Custom menu

**Setting method of Custom menu**

Custom menu 17:26, Wed  
**Cool mode**  
 Back-up heater  
 Reset energy monitor

▼ Select      [↵] Confirm

Please press  +  +  for 10 sec.

Items that can be set

① Cool mode (Set With/Without Cooling function) Default is without  
 (CAUTION) As with/without Cool mode may affect electricity application, please be careful and do not simply change it.  
 In Cool mode, please be careful if piping is not insulated properly, dew may form on pipe and water may drip on the floor and damage the floor.

② Backup heater (Use/Do not use Backup heater)  
 (CAUTION) It is different from to use/not to use backup heater set by client. When this setting is used, heater power on due to protection against frost will be disabled. (Please use this setting when it is required by utility company.)  
 By using this setting, it cannot defrost due to low Heating's setting temp and operation may stop (H75)  
 Please set under the responsibility of installer.  
 When it stops frequently, it may be due to insufficient circulation flow rate, setting temp of heating is too low etc.

③ Reset energy monitor (delete memory of Energy monitor)  
 Please use when moving house and handover the unit.

### 15.1.4 Specifications

#### 15.1.4.1 Specifications of fresh water was heat transfer medium in brazed heat exchanger

Parameter	Quality Limits for Tap Water on the Secondary Side
Temperature	Below 60°C
pH	7 to 9
Alkalinity	60mg/l <HCO <sub>3</sub> <300mg/l
Conductivity	< 500μS/cm
Hardness	[Ca <sup>+</sup> , Mg <sup>+</sup> ] / [HCO <sub>3</sub> ] > 0.5
Chloride	< 200mg/l at 60°C
Sulphate	[SO <sub>4</sub> <sup>2-</sup> ] > 100mg/l and [HCO <sub>3</sub> ] / [SO <sub>4</sub> <sup>2-</sup> ] > 1
Nitrate	NO <sub>3</sub> < 100mg/l
Chlorine	< 0.5mg/l

#### 15.1.4.2 External filter

Solids in the water must be filtered.

Minimum filter mesh size required for the field supply external filter in the water inlet is 20 mesh.

# 16. Troubleshooting Guide

## 16.1 Refrigeration Cycle System

In order to diagnose malfunctions, make sure that there are no electrical problems before inspecting the refrigeration cycle.

Such problems include insufficient insulation, problem with the power source, malfunction of a compressor and a fan.

The normal pressure of the refrigeration cycle depends on various conditions, the standard values for them are shown in the table on the right.

Normal Pressure (Standard)

	Gas pressure MPa (kg/cm <sup>2</sup> G)
Heating Mode	2.3 ~ 2.9 (23 ~ 29)
Cooling Mode	0.9 ~ 1.2 (9 ~ 12)

- ★ Condition:
- Outdoor temperature 7°C at heating mode and 35°C at cooling mode.
  - Compressor operates at rated frequency.

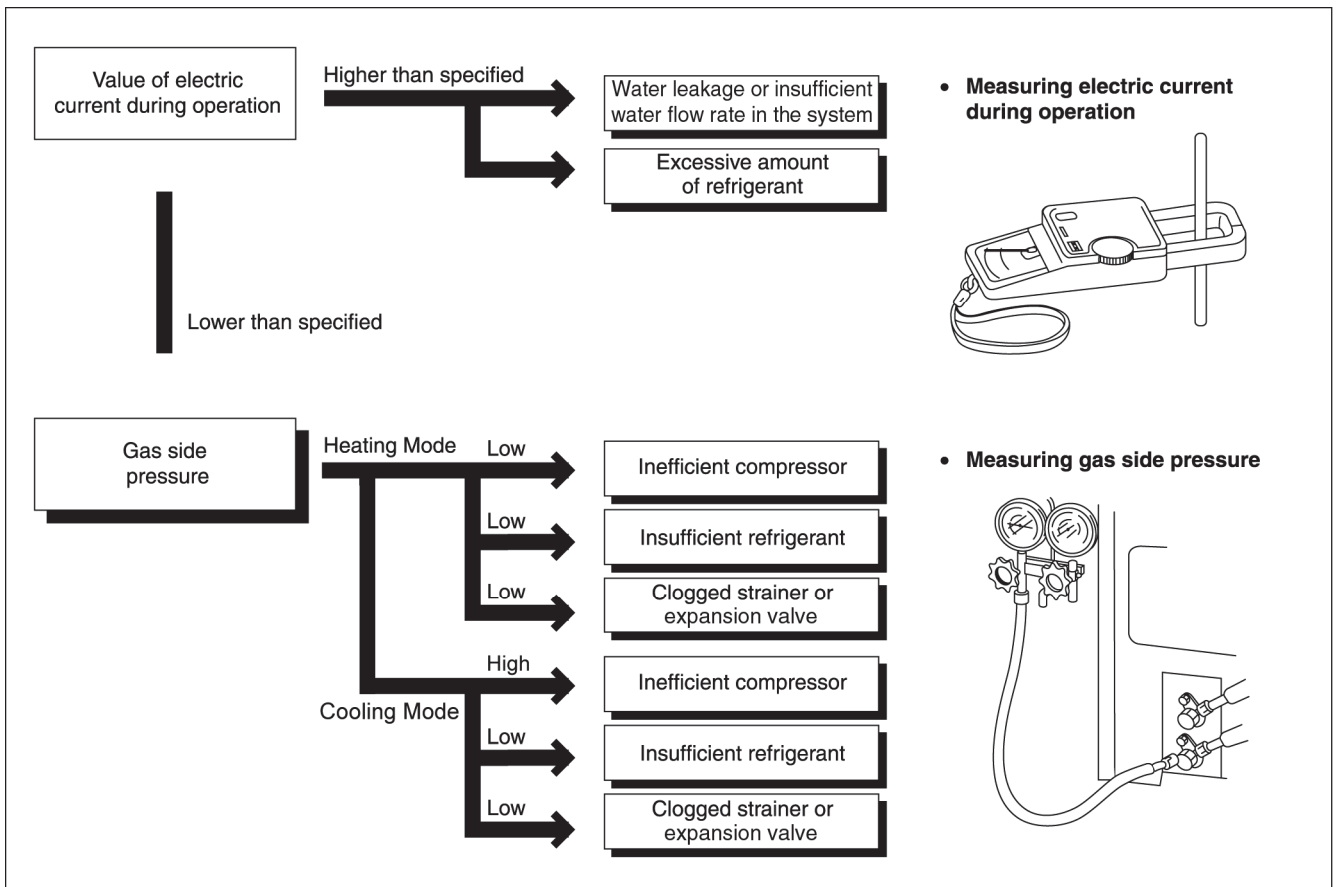

## 16.2 Relationship between the Condition of the Air-to-Water Heatpump Indoor and Outdoor Units and Pressure and Electric Current

Condition of the Air-to-Water Heatpump indoor and outdoor units	Heating Mode			Cooling Mode		
	Low Pressure	High Pressure	Electric current during operation	Low Pressure	High Pressure	Electric current during operation
Water leakage or insufficient water flow rate in the system						
Excessive amount of refrigerant						
Inefficient compression						
Insufficient refrigerant (gas leakage)						
Outdoor heat exchange deficiency						
Clogged expansion valve or Strainer						

- Carry out the measurements of pressure, electric current, and temperature fifteen minutes after an operation is started.

## 16.3 Breakdown Self Diagnosis Function

### 16.3.1 Self Diagnosis Function (Three Digits Alphanumeric Code)

- When abnormality occur during operation, the system will stop operation, and OFF/ON control panel LED will blink and error code will display on the control panel.
- Even error code is reset by turning OFF power supply or by selecting ERROR RESET, if the system abnormality is still unrepaired, system will again stop operation, and OFF/ON control panel LED will again blinks and error code will be display.
- The error code will store in IC memory.
- **To check the error code**
  - When an abnormality occurs, system will stop operation and OFF/ON control panel LED will blink.
  - Error code of the abnormality will be display on the control panel.
  - To determine the abnormality description, the error code table needs to be referred.

eg:

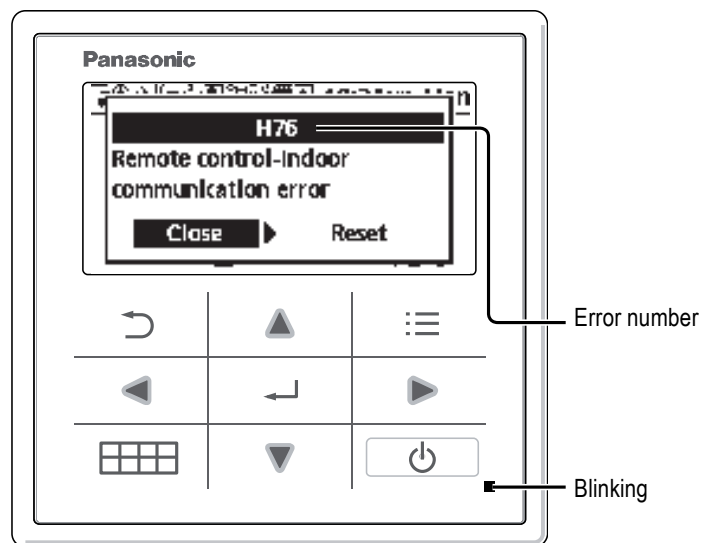

- **To display past/last error code**
  - Turn ON power supply.
  - Refer below procedure to retrieve the error code history.
- **To permanently delete error code from IC memory**
  - Turn ON power supply.
  - Refer below procedure to clear error history.

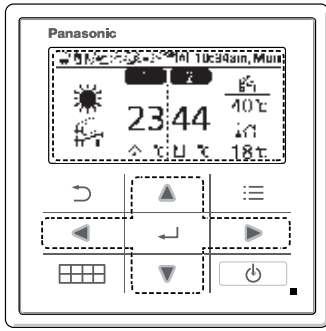

Press button and select "System Check"

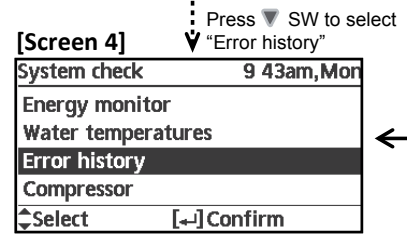
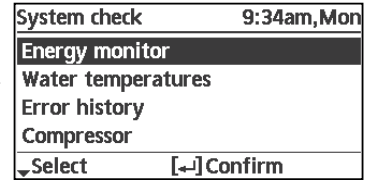
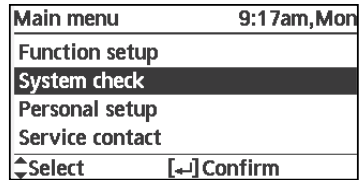

Display last 4 error retrieved from EEPROM

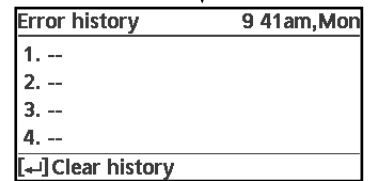
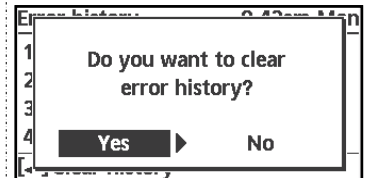
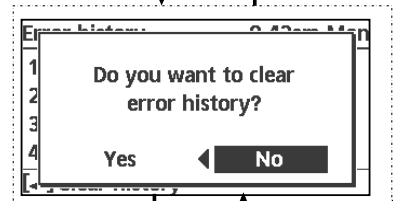
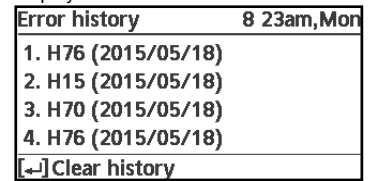



## 16.4 Error Codes Table

Diagnosis display	Abnormality/Protection control	Abnormality judgement	Primary location to verify
H00	No abnormality detected	—	—
H12	Indoor/Outdoor capacity unmatched	90s after power supply	<ul style="list-style-type: none"> <li>Indoor/outdoor connection wire</li> <li>Indoor/outdoor PCB</li> <li>Specification and combination table in catalogue</li> </ul>
H15	Outdoor compressor temperature sensor abnormality	Continue for 5 sec.	<ul style="list-style-type: none"> <li>Compressor temperature sensor (defective or disconnected)</li> </ul>
H20	Water pump abnormality	Continue for 10 sec.	<ul style="list-style-type: none"> <li>Indoor PCB</li> <li>Water pump (malfunction)</li> </ul>
H23	Indoor refrigerant liquid temperature sensor abnormality	Continue for 5 sec.	<ul style="list-style-type: none"> <li>Refrigerant liquid temperature sensor (defective or disconnected)</li> </ul>
H27	Service valve error	Continue for 5 minutes	<ul style="list-style-type: none"> <li>High pressure sensor (defective or disconnected)</li> </ul>
H28	Abnormal solar sensor	Continue for 5 sec.	<ul style="list-style-type: none"> <li>Solar temperature sensor (defective or disconnected)</li> </ul>
H31	Abnormal swimming pool sensor	Continue for 5 sec.	<ul style="list-style-type: none"> <li>Pool temperature sensor (defective or disconnected)</li> </ul>
H36	Abnormal buffer tank sensor	Continue for 5 sec.	<ul style="list-style-type: none"> <li>Buffer tank sensor (defective or disconnected)</li> </ul>
H38	Brand code not match	When indoor and outdoor brand code not same	—
H42	Compressor low pressure abnormality	—	<ul style="list-style-type: none"> <li>Outdoor pipe temperature sensor</li> <li>Clogged expansion valve or strainer</li> <li>Insufficient refrigerant</li> <li>Outdoor PCB</li> <li>Compressor</li> </ul>
H43	Abnormal Zone 1 sensor	Continue for 5 sec.	<ul style="list-style-type: none"> <li>Water temperature Zone 1 sensor</li> </ul>
H44	Abnormal Zone 2 sensor	Continue for 5 sec.	<ul style="list-style-type: none"> <li>Water temperature Zone 2 sensor</li> </ul>
H62	Water flow switch abnormality	Continue for 1 min.	<ul style="list-style-type: none"> <li>Water flow switch</li> </ul>
*H63	Refrigerant low pressure abnormality	Continue for 5 sec.	<ul style="list-style-type: none"> <li>Outdoor low pressure sensor (defective or disconnected)</li> </ul>
H64	Refrigerant high pressure abnormality	Continue for 5 sec.	<ul style="list-style-type: none"> <li>Outdoor high pressure sensor (defective or disconnected)</li> </ul>
*H65	Deice circulation error	Continue for 10 sec.	<ul style="list-style-type: none"> <li>Water flow switch sensor (defective or disconnected)</li> <li>Water pump malfunction</li> <li>Buffer tank (is used)</li> </ul>
H67	Abnormal External Thermistor 1	Continue for 5 sec.	<ul style="list-style-type: none"> <li>Room temperature Zone 1 sensor</li> </ul>
H68	Abnormal External Thermistor 2	Continue for 5 sec.	<ul style="list-style-type: none"> <li>Room temperature Zone 2 sensor</li> </ul>
H70	Back-up heater OLP abnormality	Continue for 60 sec.	<ul style="list-style-type: none"> <li>Back-up heater OLP (Disconnection or activated)</li> </ul>
H72	Tank sensor abnormal	Continue for 5 sec.	<ul style="list-style-type: none"> <li>Tank sensor</li> </ul>
H74	PCB communication error	Communication or transfer error	<ul style="list-style-type: none"> <li>Indoor main PCB and Sub PCB</li> </ul>
H75	Low water temperature control	Room heater disable and deice request to operate under low water temperature	<ul style="list-style-type: none"> <li>Heater operation must enable to increase water temperature</li> </ul>
H76	Indoor - control panel communication abnormality	—	<ul style="list-style-type: none"> <li>Indoor - control panel (defective or disconnected)</li> </ul>
H90	Indoor/outdoor abnormal communication	> 1 min after starting operation	<ul style="list-style-type: none"> <li>Internal/external cable connections</li> <li>Indoor/Outdoor PCB</li> </ul>
H91	Tank heater OLP abnormality	Continue for 60 sec.	<ul style="list-style-type: none"> <li>Tank heater OLP (Disconnection or activated)</li> </ul>
H95	Indoor/Outdoor wrong connection	—	<ul style="list-style-type: none"> <li>Indoor/Outdoor supply voltage</li> </ul>
H98	Outdoor high pressure overload protection	—	<ul style="list-style-type: none"> <li>Outdoor high pressure sensor</li> <li>Water pump or water leakage</li> <li>Clogged expansion valve or strainer</li> <li>Excess refrigerant</li> <li>Outdoor PCB</li> </ul>
H99	Indoor heat exchanger freeze prevention	—	<ul style="list-style-type: none"> <li>Indoor heat exchanger</li> <li>Refrigerant shortage</li> </ul>
F12	Pressure switch activate	4 times occurrence within 20 minutes	<ul style="list-style-type: none"> <li>Pressure switch</li> </ul>
F14	Outdoor compressor abnormal revolution	4 times occurrence within 20 minutes	<ul style="list-style-type: none"> <li>Outdoor compressor</li> </ul>
F15	Outdoor fan motor lock abnormality	2 times occurrence within 30 minutes	<ul style="list-style-type: none"> <li>Outdoor PCB</li> <li>Outdoor fan motor</li> </ul>
F16	Total running current protection	3 times occurrence within 20 minutes	<ul style="list-style-type: none"> <li>Excess refrigerant</li> <li>Outdoor PCB</li> </ul>

Diagnosis display	Abnormality/Protection control	Abnormality judgement	Primary location to verify
F20	Outdoor compressor overheating protection	4 times occurrence within 30 minutes	<ul style="list-style-type: none"> <li>Compressor tank temperature sensor</li> <li>Clogged expansion valve or strainer</li> <li>Insufficient refrigerant</li> <li>Outdoor PCB</li> <li>Compressor</li> </ul>
F22	IPM (power transistor) overheating protection	3 times occurrence within 30 minutes	<ul style="list-style-type: none"> <li>Improper heat exchange</li> <li>IPM (Power transistor)</li> </ul>
F23	Outdoor Direct Current (DC) peak detection	7 times occurrence continuously	<ul style="list-style-type: none"> <li>Outdoor PCB</li> <li>Compressor</li> </ul>
F24	Refrigeration cycle abnormality	2 times occurrence within 20 minutes	<ul style="list-style-type: none"> <li>Insufficient refrigerant</li> <li>Outdoor PCB</li> <li>Compressor low compression</li> </ul>
F25	Cooling/Heating cycle changeover abnormality	4 times occurrence within 30 minutes	<ul style="list-style-type: none"> <li>4-way valve</li> <li>V-coil</li> </ul>
F27	Pressure switch abnormality	Continue for 1 min.	<ul style="list-style-type: none"> <li>Pressure switch</li> </ul>
F29	Low Discharge Superheat	1 times occurrence within 2550 minutes	<ul style="list-style-type: none"> <li>Discharge Temperature Sensor</li> <li>Discharge Pressure Sensor</li> <li>Pressure Switch</li> <li>Outdoor PCB</li> </ul>
F30	Water outlet sensor 2 abnormality	Continue for 5 sec.	<ul style="list-style-type: none"> <li>Water outlet sensor 2 (defective or disconnected)</li> </ul>
F32	Abnormal Internal Thermostat	Continue for 5 sec.	<ul style="list-style-type: none"> <li>Control panel PCB thermostat</li> </ul>
F36	Outdoor air temperature sensor abnormality	Continue for 5 sec.	<ul style="list-style-type: none"> <li>Outdoor air temperature sensor (defective or disconnected)</li> </ul>
F37	Indoor water inlet temperature sensor abnormality	Continue for 5 sec.	<ul style="list-style-type: none"> <li>Water inlet temperature sensor (defective or disconnected)</li> </ul>
F40	Outdoor discharge pipe temperature sensor abnormality	Continue for 5 sec.	<ul style="list-style-type: none"> <li>Outdoor discharge pipe temperature sensor (defective or disconnected)</li> </ul>
F41	PFC control	4 times occurrence within 10 minutes	<ul style="list-style-type: none"> <li>Voltage at PFC</li> </ul>
F42	Outdoor heat exchanger temperature sensor abnormality	Continue for 5 sec.	<ul style="list-style-type: none"> <li>Outdoor heat exchanger temperature sensor (defective or disconnected)</li> </ul>
F43	Outdoor defrost sensor abnormality	Continue for 5 sec.	<ul style="list-style-type: none"> <li>Outdoor defrost sensor (defective or disconnected)</li> </ul>
F45	Indoor water outlet temperature sensor abnormality	Continue for 5 sec.	<ul style="list-style-type: none"> <li>Water outlet temperature sensor (defective or disconnected)</li> </ul>
F46	Outdoor Current Transformer open circuit	—	<ul style="list-style-type: none"> <li>Insufficient refrigerant</li> <li>Outdoor PCB</li> <li>Compressor low</li> </ul>
F48	Outdoor EVA outlet temperature sensor abnormality	Continue for 5 sec.	<ul style="list-style-type: none"> <li>Outdoor EVA outlet temperature sensor (defective or disconnected)</li> </ul>
F49	Outdoor bypass outlet temperature sensor abnormality	Continue for 5 sec.	<ul style="list-style-type: none"> <li>Outdoor bypass outlet temperature sensor (defective or disconnected)</li> </ul>
F95	Cooling high pressure overload protection	—	<ul style="list-style-type: none"> <li>Outdoor high pressure sensor</li> <li>Water pump or water leakage</li> <li>Clogged expansion valve or strainer</li> <li>Excess refrigerant</li> <li>Outdoor PCB</li> </ul>

**Note:** \* This error code is not applicable for this system.

## 16.5 Self-diagnosis Method

### 16.5.1 Connection Capability Rank Abnormality (H12)

#### Malfunction Decision Conditions:

During startup operation of cooling and heating, the capability rank of indoor checked by the outdoor is used to determine connection capability rank abnormality.

#### Malfunction Caused:

- 1 Wrong model interconnected.
- 2 Wrong indoor unit or outdoor unit PCB (main) used.
- 3 Faulty indoor unit or outdoor unit PCB (main).

#### Abnormality Judgment:

Continue for 90 seconds.

#### Troubleshooting:

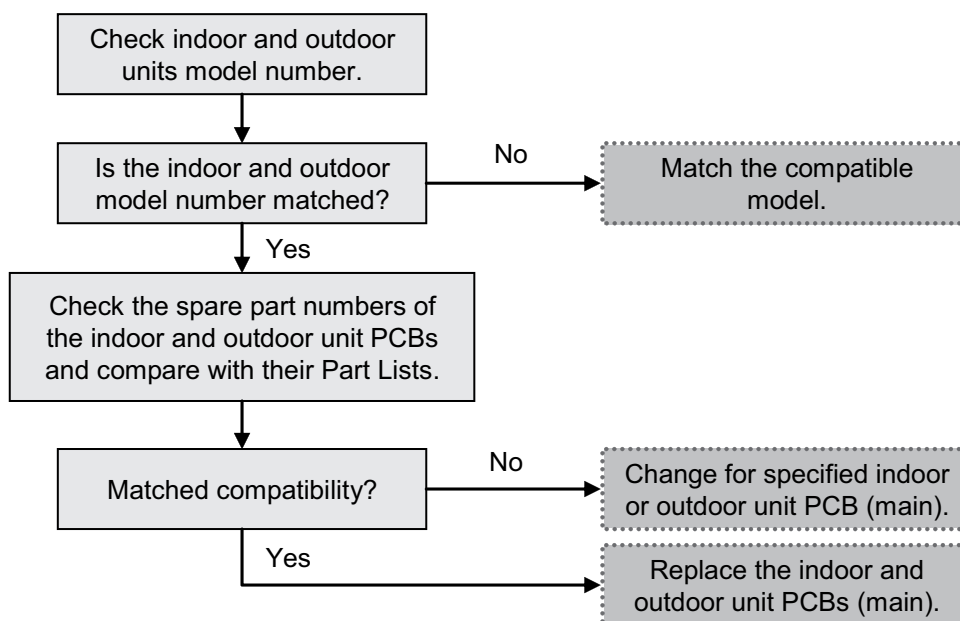

## 16.5.2 Compressor Tank Temperature Sensor Abnormality (H15)

### Malfunction Decision Conditions:

During startup and operation of cooling and heating, the temperatures detected by the compressor tank temperature sensor are used to determine sensor error.

### Malfunction Caused:

- 1 Faulty connector connection.
- 2 Faulty sensor.
- 3 Faulty outdoor unit PCB (main).

### Abnormality Judgment:

Continue for 5 seconds.

### Troubleshooting:

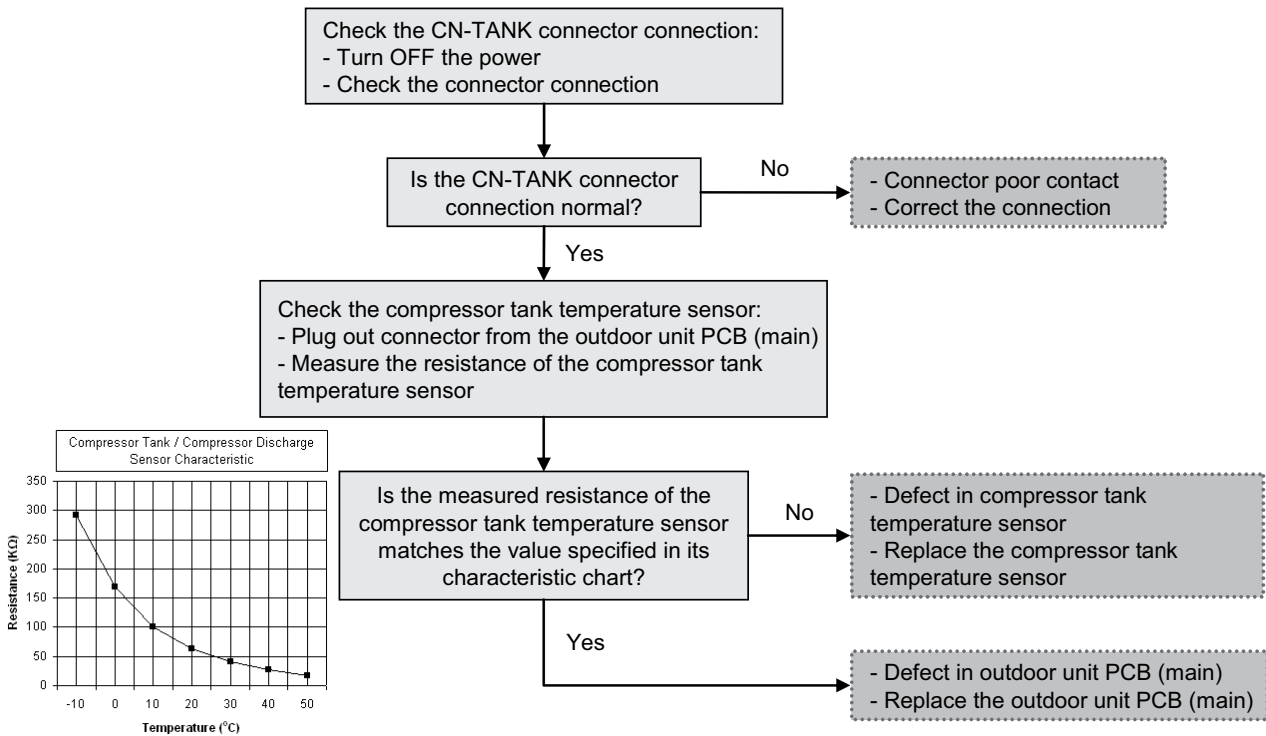

### 16.5.3 Water Pump Abnormality (H20)

#### Malfunction Decision Conditions:

During startup and operation of cooling and heating, the rotation speed detected by the IPM of water pump motor during water pump operation is used to determine abnormal water pump (feedback of rotation > 6,000rpm or < 1,000rpm).

#### Malfunction Caused:

- 1 Operation stop due to short circuit inside the water pump motor winding.
- 2 Operation stop due to breaking of wire inside the water pump motor.
- 3 Operation stop due to breaking of water pump lead wires.
- 4 Operation stop due to water pump motor IPM malfunction.
- 5 Operation error due to faulty indoor unit PCB.

#### Abnormality Judgment:

Continue for 5 seconds.

#### Troubleshooting:



**Caution**

For safety reason and to prevent component breakdown, always switch off the power before remove and connect the component.

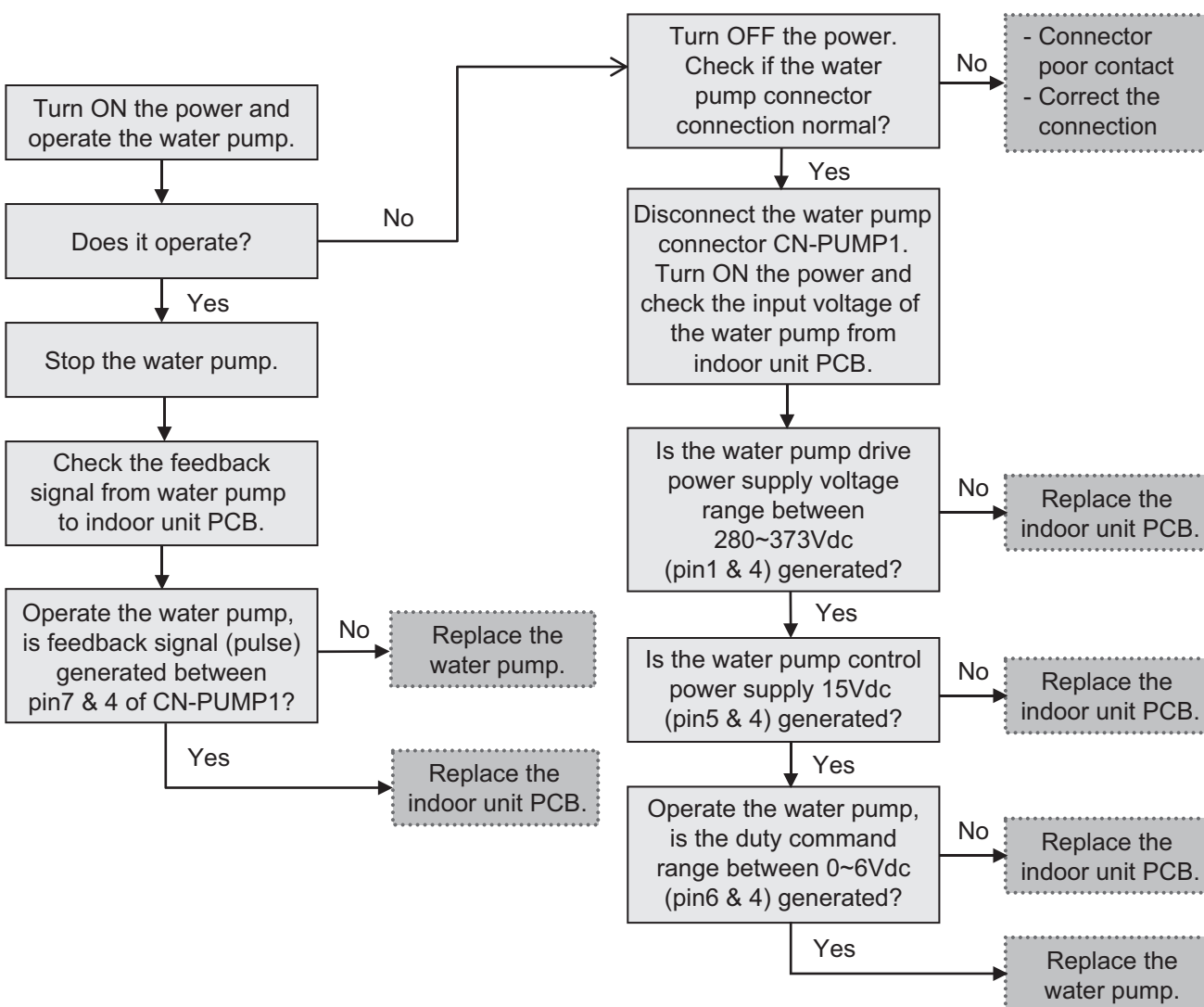

## 16.5.4 Indoor Refrigerant Liquid Temperature Sensor Abnormality (H23)

### Malfunction Decision Conditions:

During startup and operation of cooling and heating, the temperatures detected by the indoor refrigerant liquid temperature sensor are used to determine sensor error.

### Malfunction Caused:

- 1 Faulty connector connection.
- 2 Faulty sensor.
- 3 Faulty indoor unit PCB (main).

### Abnormality Judgment:

Continue for 5 seconds.

### Troubleshooting:



For safety reason and to prevent component breakdown, always switch off the power before remove and connect the component.

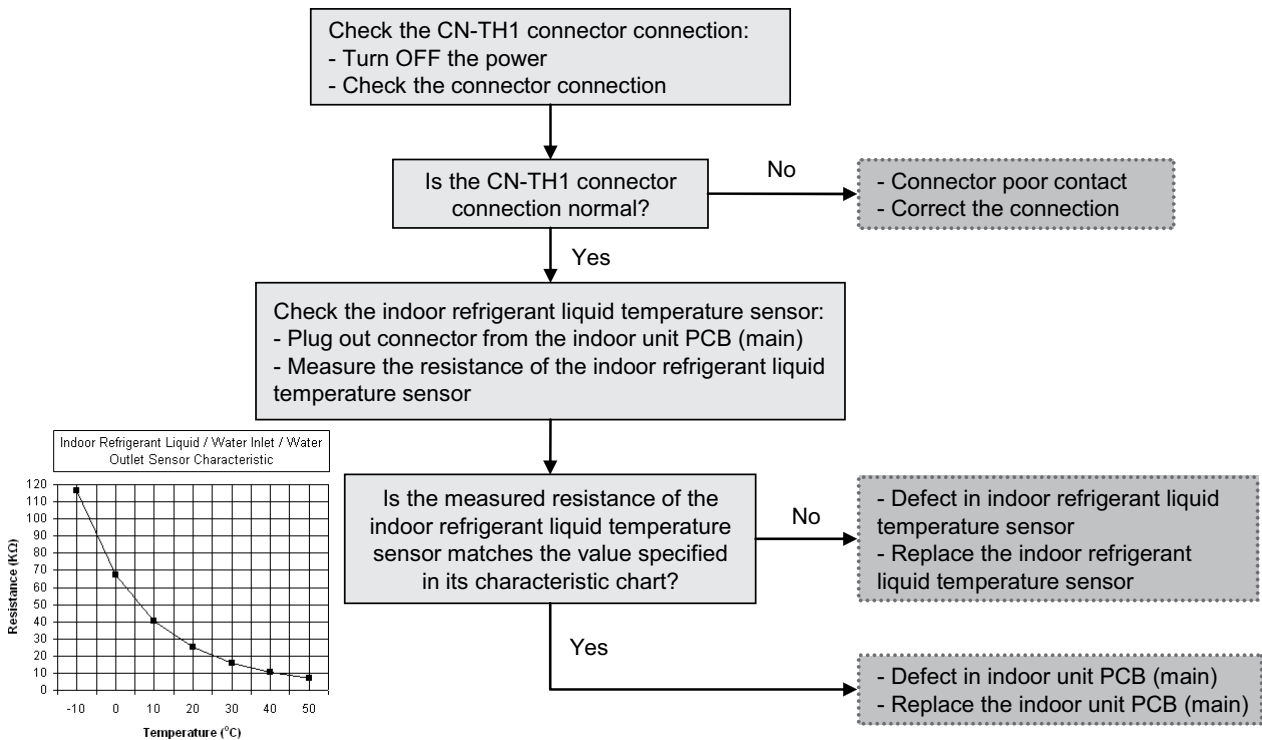

## 16.5.5 Service Valve Error (H27)

### Malfunction Decision Conditions:

During cooling operation, when:-

[a] Indoor refrigerant pipe temperature at compressor startup - present indoor refrigerant pipe temperature < 2°C

[b] Present high pressure - high pressure at compressor startup < 5kg/cm<sup>2</sup>

\*\*Judgment only for first time cooling operation and not during pump down operation.

### Malfunction Caused:

- 1 3 way valves closed.
- 2 Faulty high pressure sensor.
- 3 Faulty indoor refrigerant pipe temperature sensor
- 4 Faulty outdoor unit PCB (main).

### Abnormality Judgment:

Continue for 5 minutes.

### Troubleshooting:



**Caution**

For safety reason and to prevent component breakdown, always switch off the power before remove and connect the component.

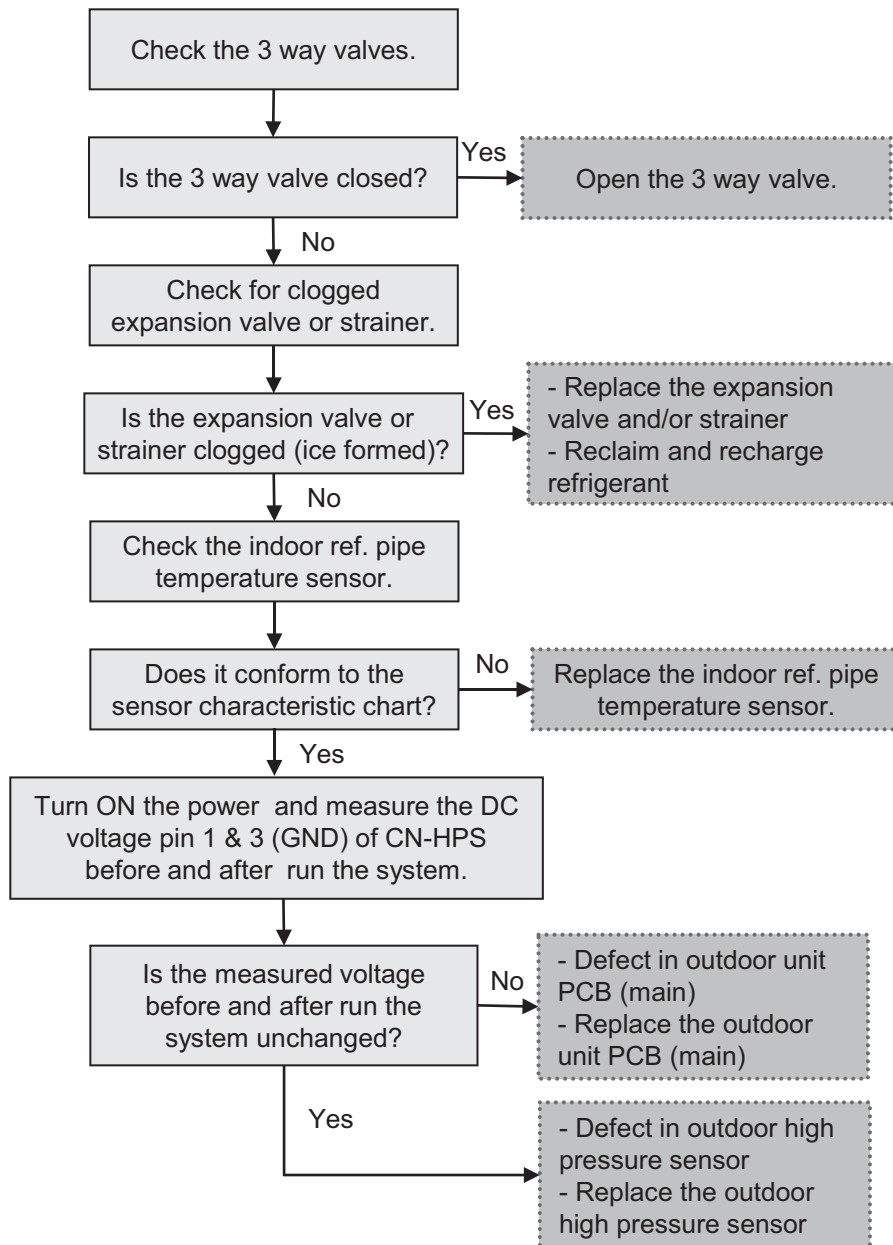

## 16.5.6 Abnormal Solar Sensor (H28)

### Malfunction Caused:

- 1 Faulty connector connection.
- 2 Faulty solar sensor.
- 3 Faulty indoor sub PCB.

### Abnormality Judgment:

Continue for 5 seconds.

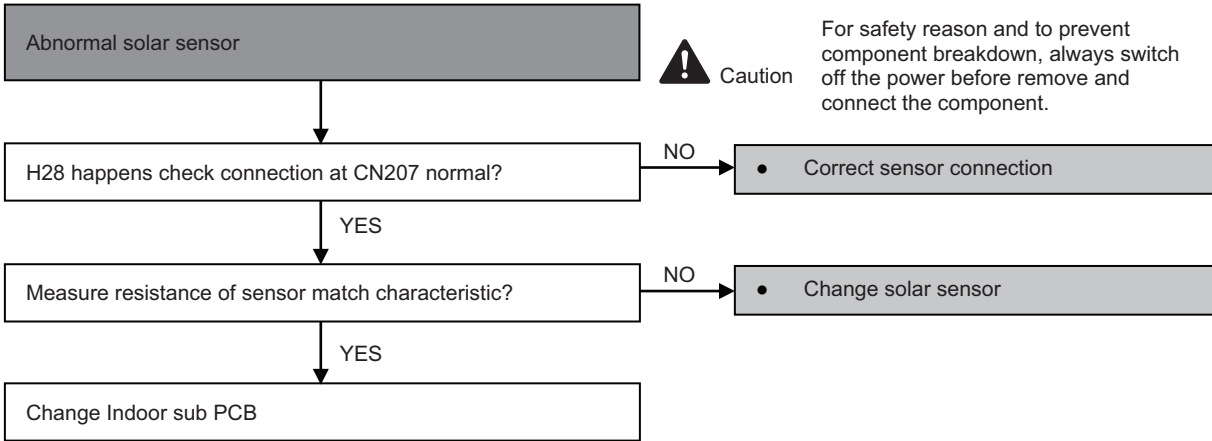



### 16.5.7 Abnormal Swimming Pool Sensor (H31)

**Malfunction Caused:**

- 1 Faulty connector connection.
- 2 Faulty swimming pool sensor.
- 3 Faulty indoor sub PCB.

**Abnormality Judgment:**

Continue for 5 seconds.

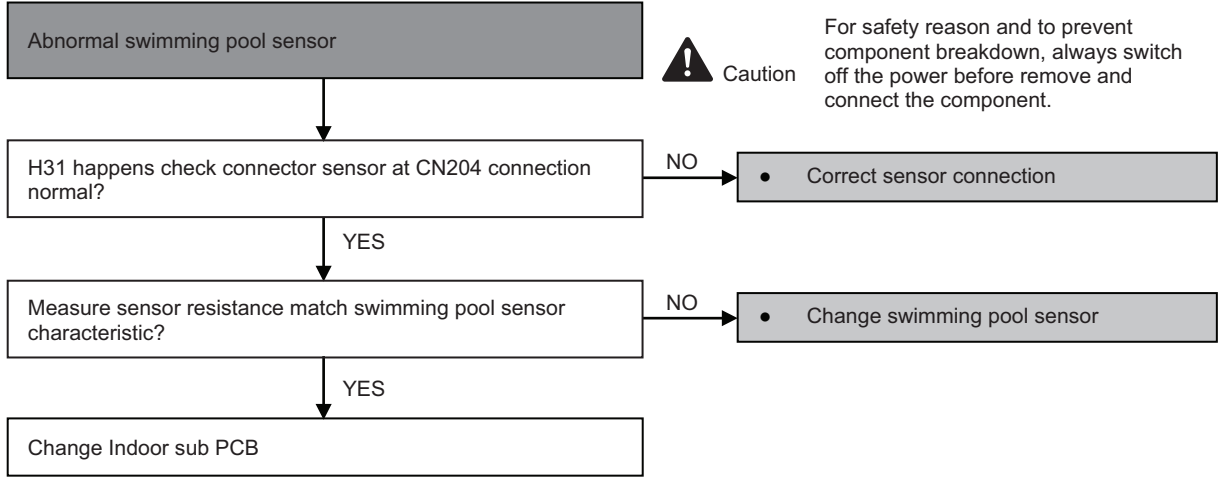

## 16.5.8 Abnormal Buffer Tank Sensor (H36)

### Malfunction Caused:

- 1 Faulty connector connection.
- 2 Faulty buffer tank sensor.
- 3 Faulty indoor sub PCB.

### Abnormality Judgment:

Continue for 5 seconds.

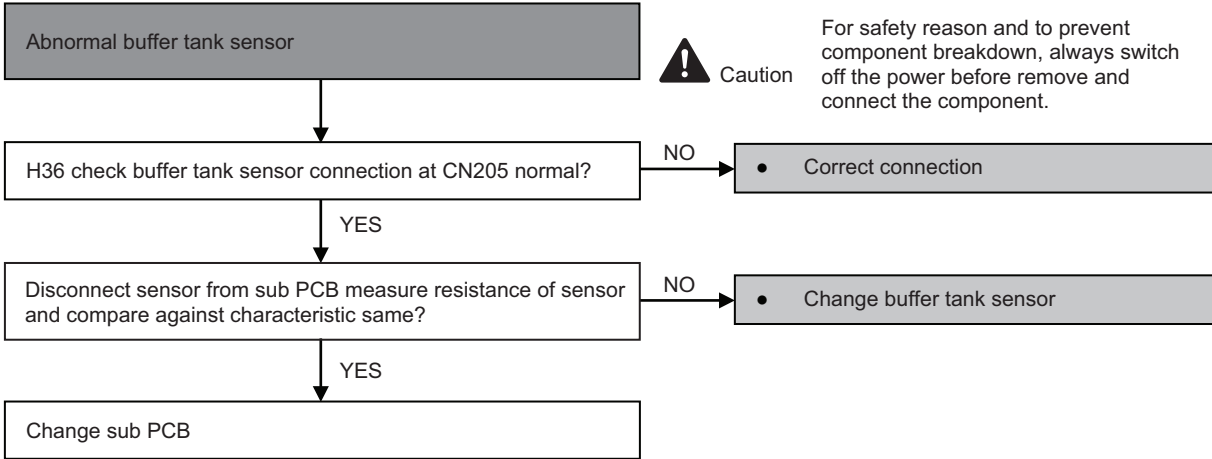

### 16.5.9 Brand Code Not Matching (H38)

#### Malfunction Caused:

- 1 Indoor and outdoor brand code not match.

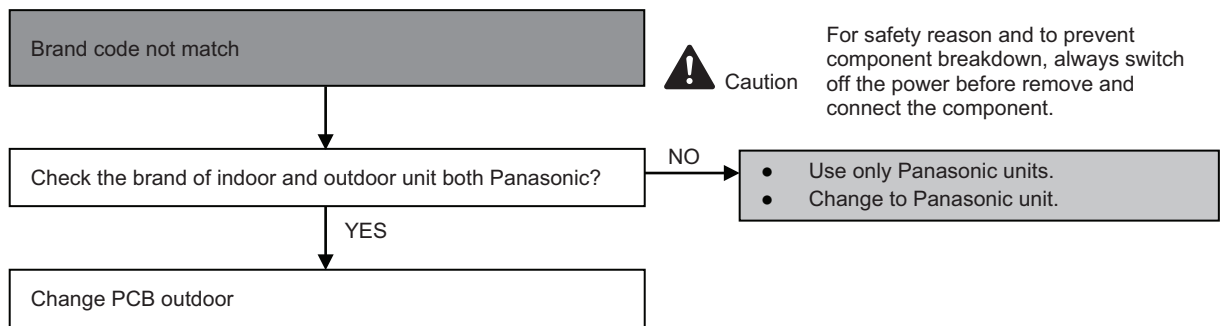

## 16.5.10 Compressor Low Pressure Protection (H42)

### Malfunction Decision Conditions:

During operation of heating and after 5 minutes compressor ON, when outdoor pipe temperature below  $-29^{\circ}\text{C}$  or above  $26^{\circ}\text{C}$  is detected by the outdoor pipe temperature sensor.

### Malfunction Caused:

- 1 Dust accumulation on the outdoor unit heat exchanger.
- 2 Air short circuit at outdoor unit.
- 3 2 way valve partially closed.
- 4 Faulty outdoor unit fan motor.
- 5 Refrigerant shortage (refrigerant leakage).
- 6 Clogged expansion valve or strainer.
- 7 Faulty outdoor pipe temperature sensor.
- 8 Faulty outdoor unit main PCB (main).

### Troubleshooting:



For safety reason and to prevent component breakdown, always switch off the power before remove and connect the component.

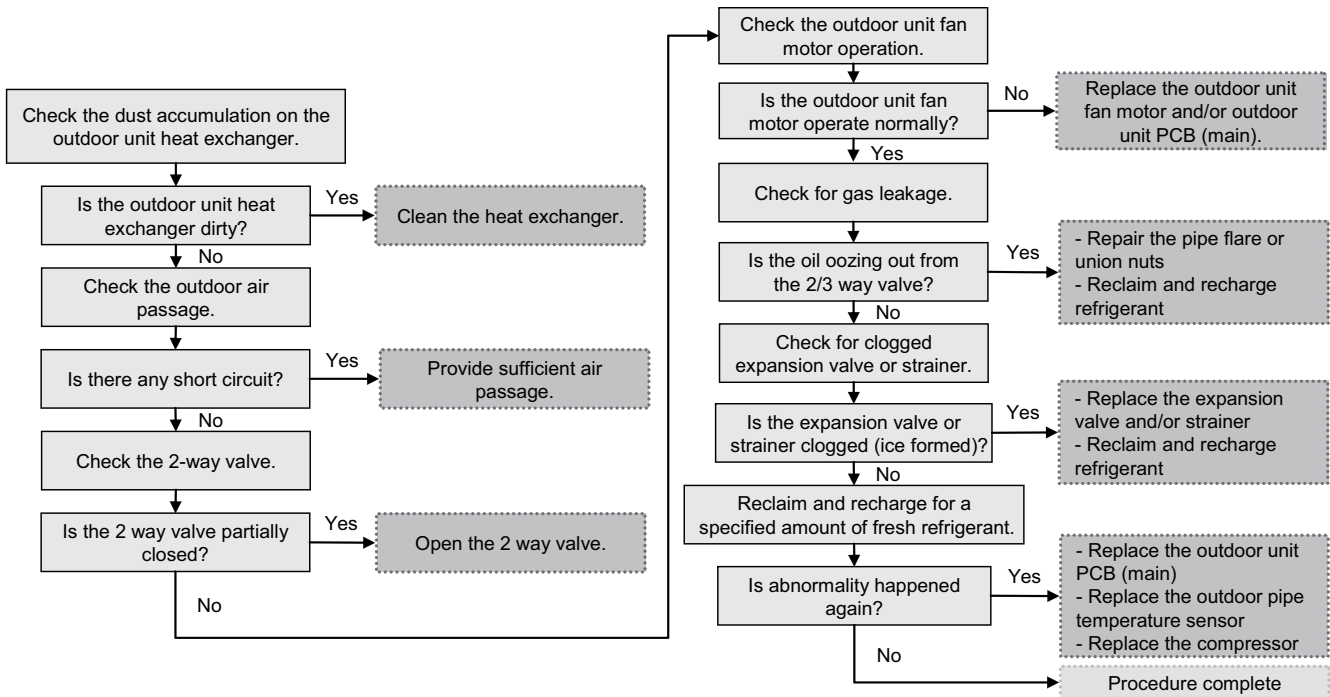

### 16.5.11 Abnormal Zone 1 Sensor (H43)

- 1 Faulty connector connection.
- 2 Faulty buffer tank sensor.
- 3 Faulty indoor sub PCB.

#### Abnormality Judgment:

Continue for 5 seconds.

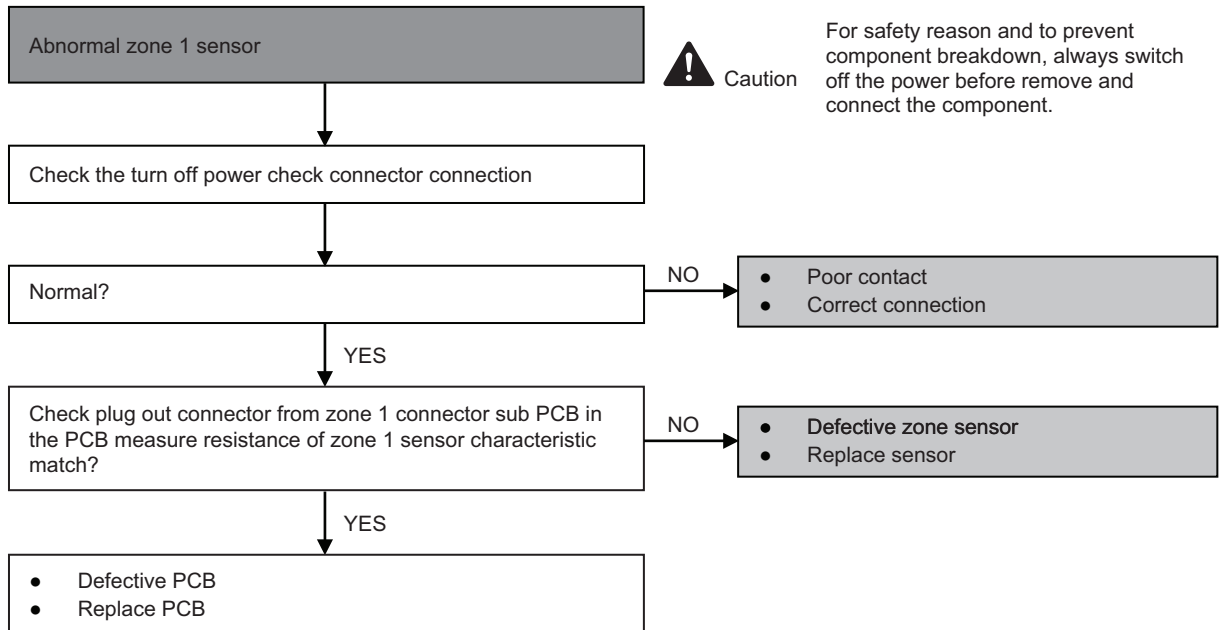

## 16.5.12 Abnormal Zone 2 Sensor (H44)

### Malfunction Caused:

- 1 Faulty connector connection.
- 2 Faulty buffer tank sensor.
- 3 Faulty indoor sub PCB.

### Abnormality Judgment:

Continue for 5 seconds.

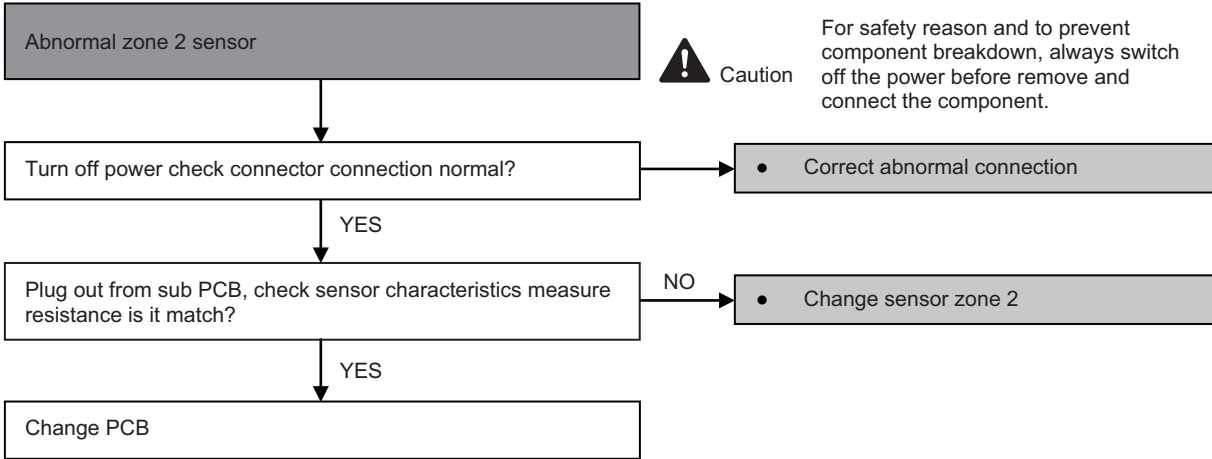

### 16.5.13 Water Flow Switch Abnormality (H62)

**Malfunction Decision Conditions:**

During operation of cooling and heating, the water flow detected by the indoor water flow switch is used to determine water flow error.

**Malfunction Caused:**

- 1 Faulty water pump.
- 2 Water leak in system.
- 3 Faulty connector connection.
- 4 Faulty water flow switch.
- 5 Faulty indoor unit PCB (main).

**Abnormality Judgment:**

Continue for 10 seconds (but no judgment for 9 minutes after compressor startup/restart).

**Troubleshooting:**



For safety reason and to prevent component breakdown, always switch off the power before remove and connect the component.

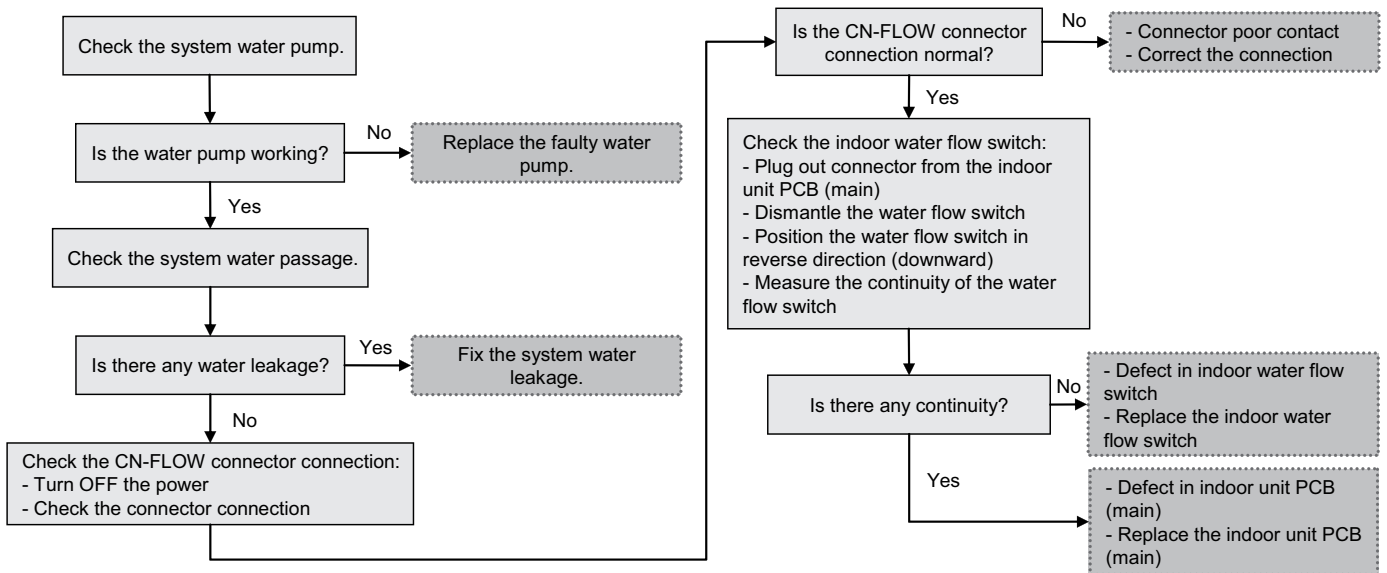

## 16.5.14 Outdoor High Pressure Abnormality (H64)

### Malfunction Decision Conditions:

During operation of cooling and heating, when the outdoor high pressure sensor output signal is 0 Vdc or 5 Vdc.

### Malfunction Caused:

- 1 Faulty connector connection.
- 2 Faulty sensor.
- 3 Faulty outdoor unit PCB (main).

### Abnormality Judgment:

Continue 4 times in 20 minutes.

### Troubleshooting:



For safety reason and to prevent component breakdown, always switch off the power before remove and connect the component.

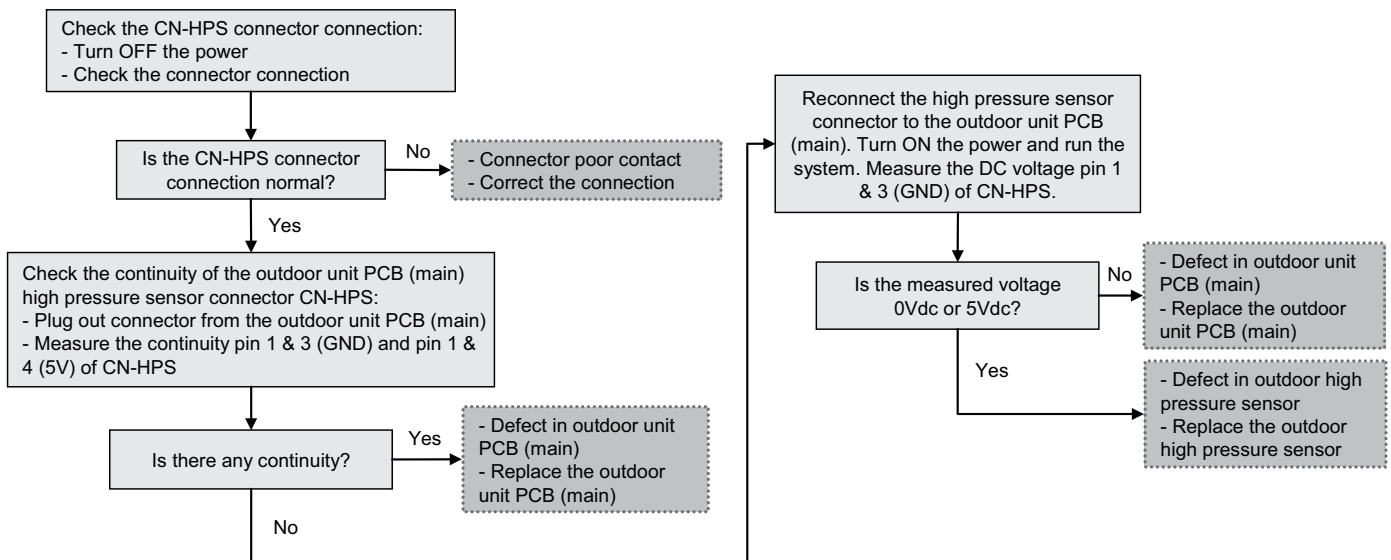



## 16.5.15 Deice Circulation Error (H65)

### Malfunction Decision Conditions:

During startup and operation of deice (mode 2), the water flow (> 10l/min) detected by the water flow switch is used to determine deice circulation error.

### Malfunction Caused:

- 1 Water flow in air-to-water heatpump indoor unit circuitry.
- 2 Faulty indoor unit water flow switch.
- 3 Faulty indoor unit water pump.
- 4 Faulty indoor unit PCB.

### Abnormality Judgment:

Continue for 10 seconds.

### Troubleshooting: Caution

For safety reason and to prevent component breakdown, always switch off the power before remove and connect the component.

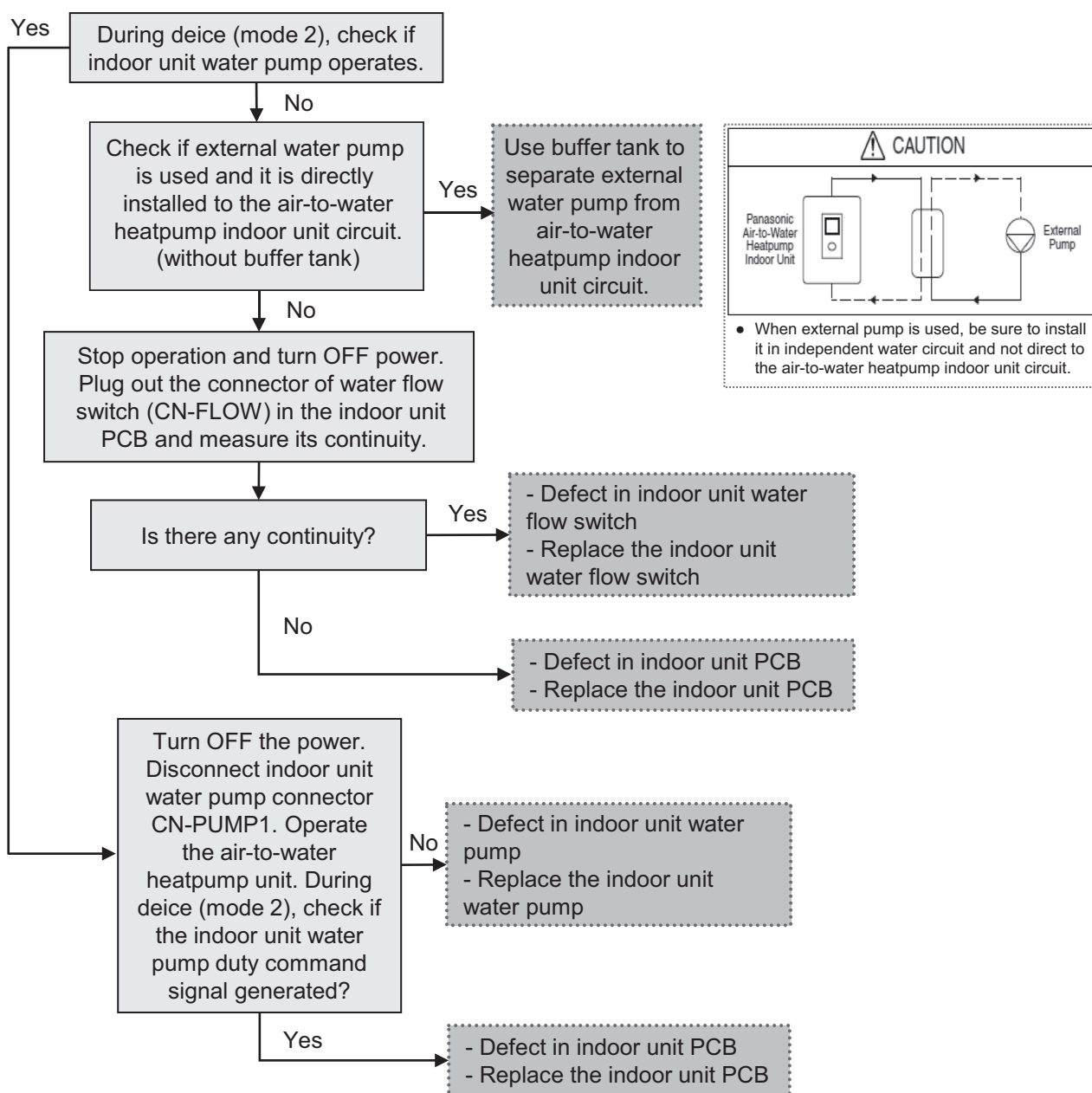

## 16.5.16 Abnormal External Thermistor 1 (H67)

### Malfunction Caused:

- 1 Faulty connector connection.
- 2 Faulty room temperature zone 1 sensor.
- 3 Faulty indoor sub PCB.

### Abnormality Judgment:

Continue for 5 seconds.

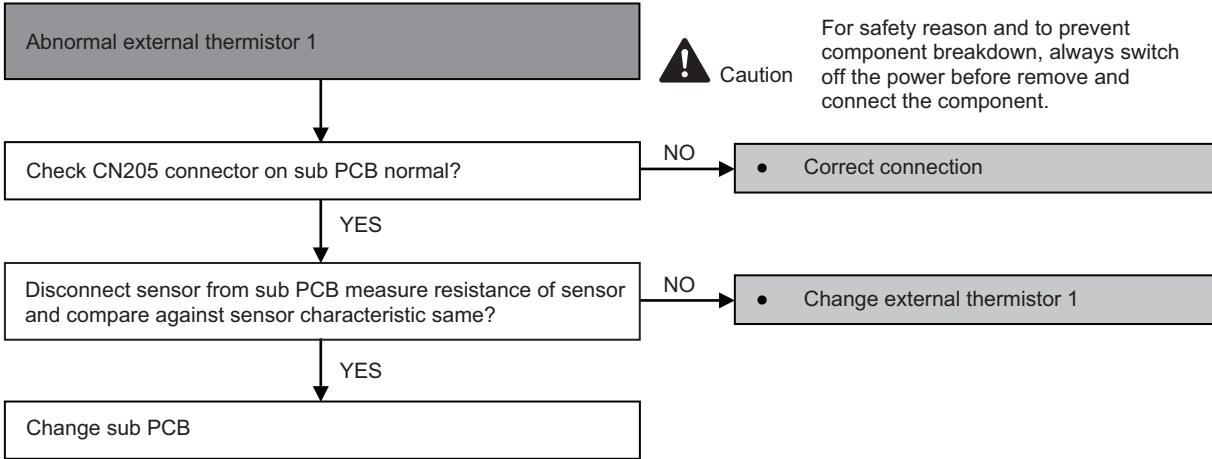

## 16.5.17 Abnormal External Thermistor 2 (H68)

### Malfunction Caused:

- 1 Faulty connector connection.
- 2 Faulty room temperature zone 2 sensor.
- 3 Faulty indoor sub PCB.

### Abnormality Judgment:

Continue for 5 seconds.

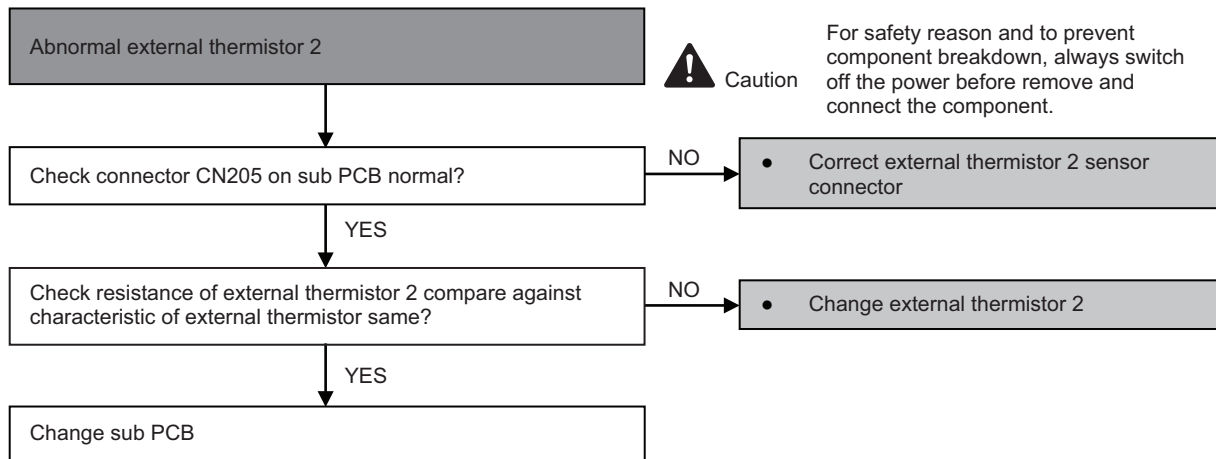

## 16.5.18 Indoor Backup Heater OLP Abnormality (H70)

### Malfunction Decision Conditions:

During operation of indoor backup heater, when no power supplies to indoor backup heater or OLP open circuit.

### Malfunction Caused:

- 1 Faulty power supply connector connection.
- 2 Faulty connector connection.
- 3 Faulty indoor backup heater overload protector (OLP).
- 4 Faulty indoor unit PCB (main).

### Abnormality Judgment:

Continue for 60 seconds.

### Troubleshooting:



**Caution**

For safety reason and to prevent component breakdown, always switch off the power before remove and connect the component.

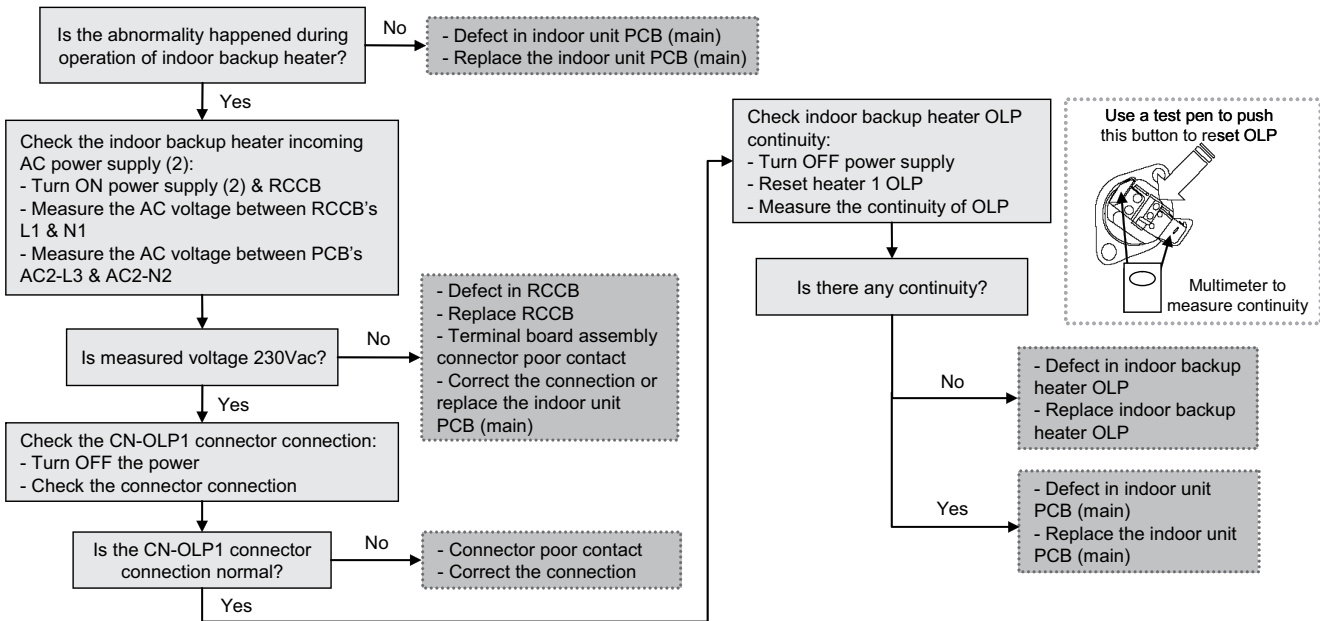

## 16.5.19 Tank Temperature Sensor Abnormality (H72)

### Malfunction Decision Conditions:

When tank connection is set to ON, the temperatures detected by the tank temperature sensor are used to determine sensor error.

### Malfunction Caused:

- 1 Faulty connector connection.
- 2 Faulty sensor.
- 3 Faulty indoor unit PCB (main).

### Abnormality Judgment:

Continue for 5 seconds.

### Troubleshooting:



**Caution**

For safety reason and to prevent component breakdown, always switch off the power before remove and connect the component.

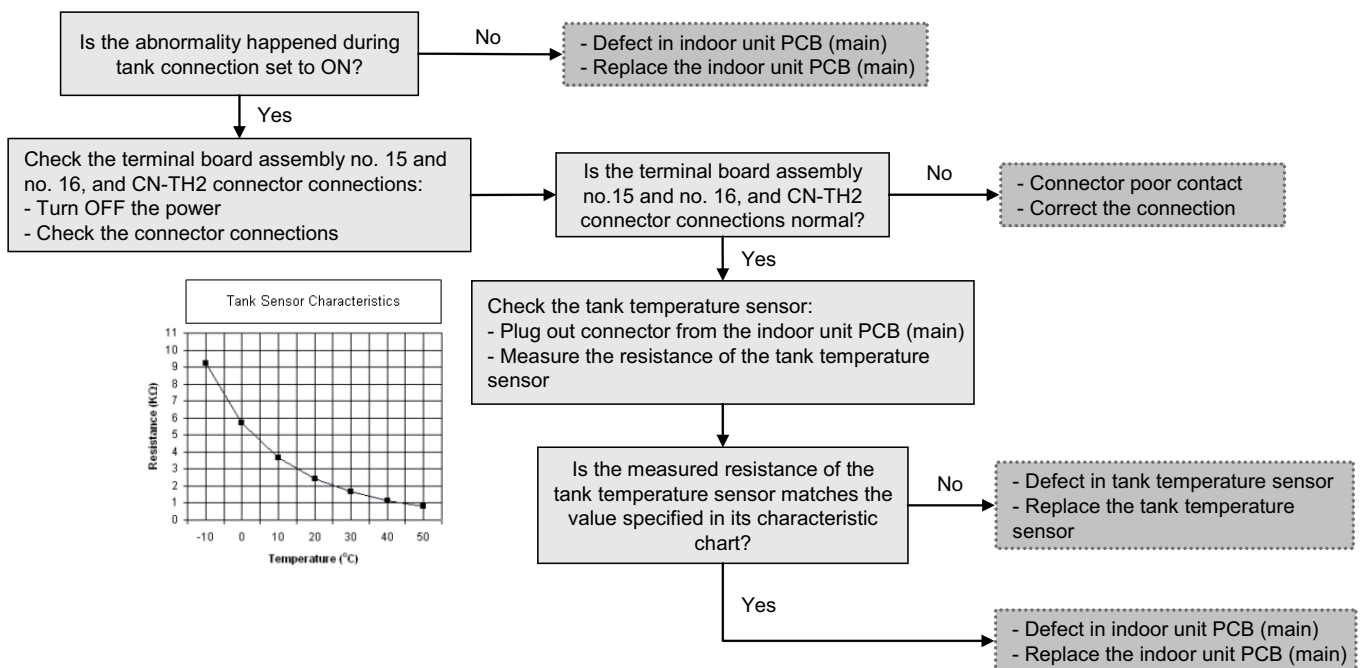

## 16.5.20 PCB Communication Error (H74)

### Malfunction Decision Condition:

When External PCB connection is select "YES" and no communication or transfer error between Main PCB and External PCB for 10 seconds and above.

### Malfunction Caused:

- 1 Faulty connector connection
- 2 Faulty Indoor Main PCB
- 3 Faulty External PCB

### Abnormality Judgment:

Continue for 10 seconds



### Caution

For safety reason and to prevent component breakdown, always switch off the power before remove and connect the component.

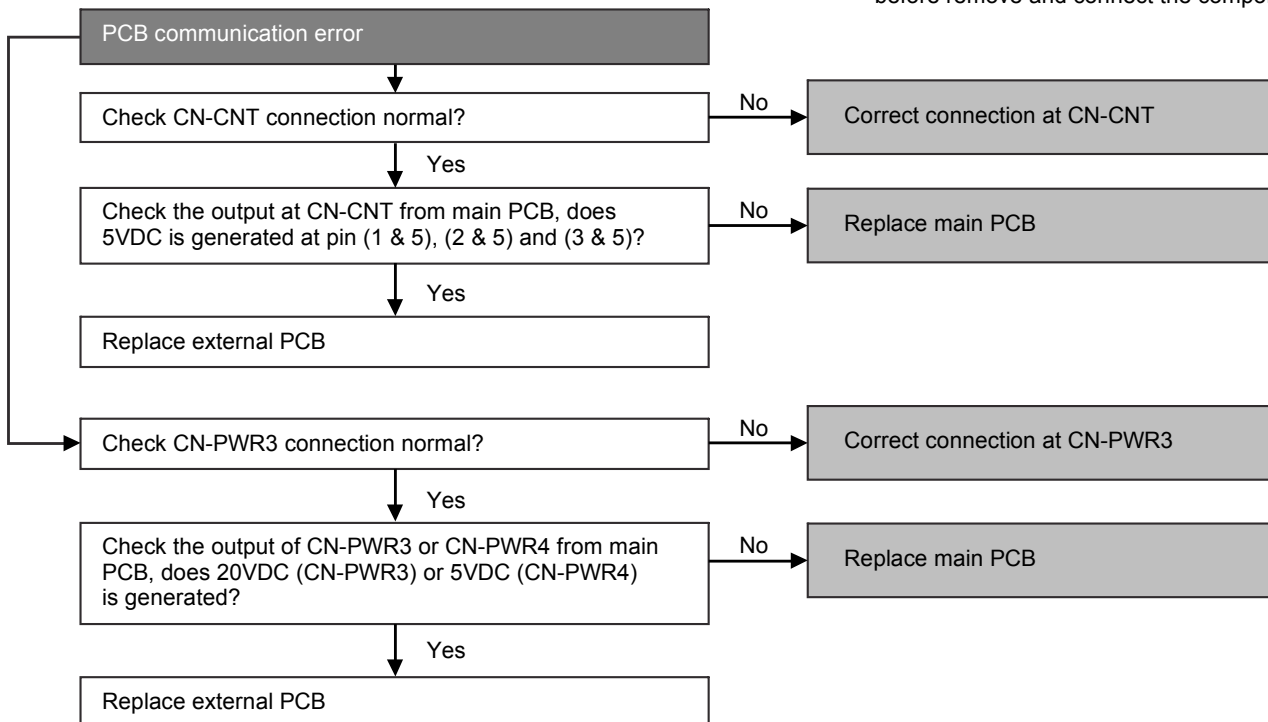

## 16.5.21 Low Water Temperature Control (H75)

### Malfunction Decision Condition:

When Back-up heater disable and Deice request to operate under low water temperature

### Malfunction Caused:

- 1 Back-up heater "Disable" under custom menu

### Abnormality Judgment:

HEX protection under Low water temperature HEX protection control.



#### Caution

For safety reason and to prevent component breakdown, always switch off the power before remove and connect the component.

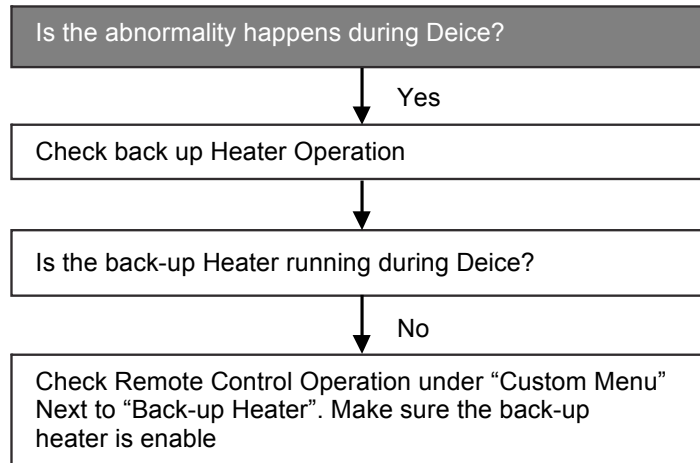

## 16.5.22 Indoor-Control Panel Communication Abnormality (H76)

### Malfunction Decision Conditions:

During standby and operation of cooling and heating, indoor-control panel error occur.

### Malfunction Caused:

- 1 Faulty connector connection.
- 2 Faulty control panel.
- 3 Faulty indoor unit PCB (main).

### Troubleshooting:



**Caution**

For safety reason and to prevent component breakdown, always switch off the power before remove and connect the component.

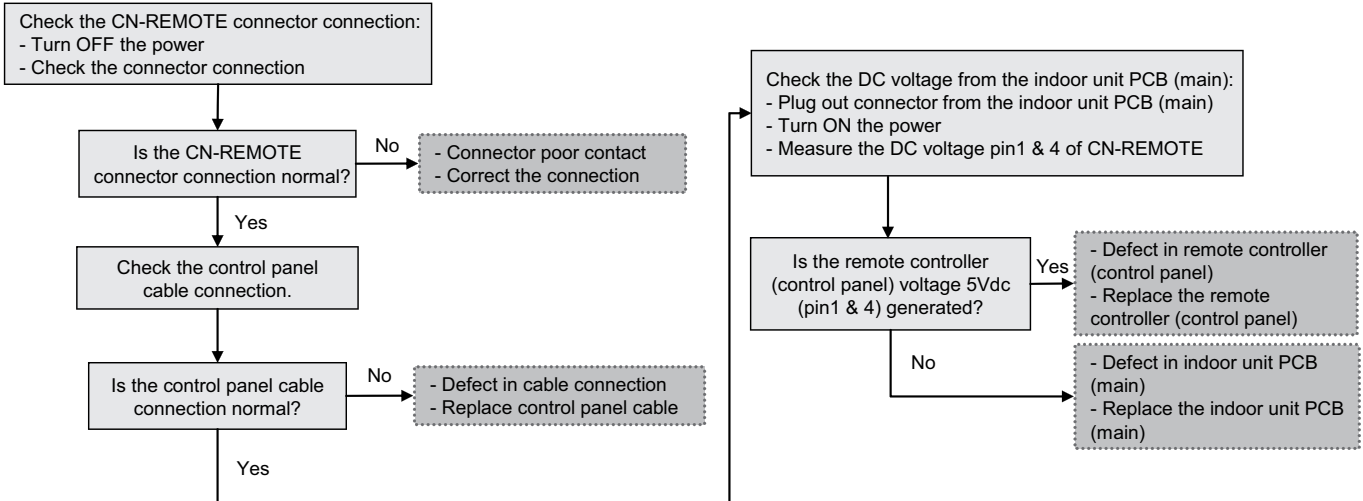



### 16.5.23 Indoor/Outdoor Abnormal Communication (H90)

**Malfunction Decision Conditions:**

During operation of cooling and heating, the data received from outdoor unit in indoor unit signal transmission is checked whether it is normal.

**Malfunction Caused:**

- 1 Faulty outdoor unit PCB (main).
- 2 Faulty indoor unit PCB (main).
- 3 Indoor-outdoor signal transmission error due to wrong wiring.
- 4 Indoor-outdoor signal transmission error due to breaking of wire in the connection wires between the indoor and outdoor units.
- 5 Indoor-outdoor signal transmission error due to disturbed power supply waveform.

**Abnormality Judgment:**

Continue for 1 minute after operation.

**Troubleshooting:**



For safety reason and to prevent component breakdown, always switch off the power before remove and connect the component.

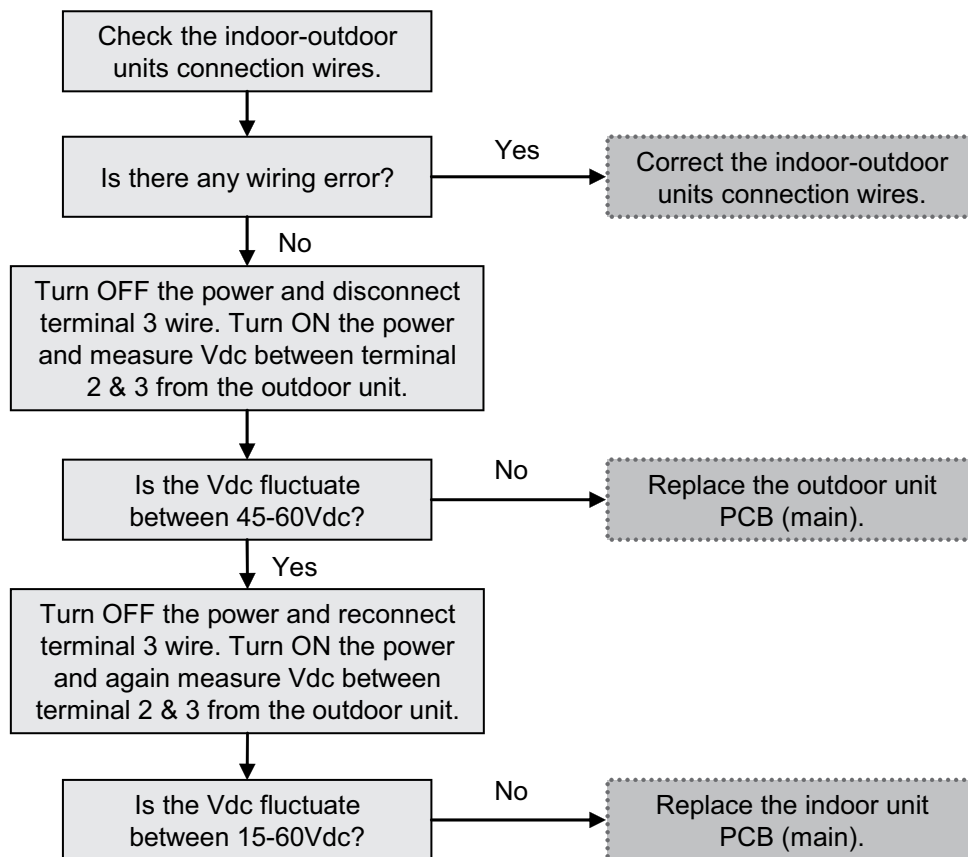

## 16.5.24 Tank Booster Heater OLP Abnormality (H91)

### Malfunction Decision Conditions:

During operation of tank booster heater, and tank booster heater OLP open circuit.

### Malfunction Caused:

- 1 Faulty connector connection.
- 2 Faulty tank booster heater overload protector (OLP).
- 3 Faulty indoor unit PCB (main).

### Abnormality Judgment:

Continue for 60 seconds.

### Troubleshooting:



**Caution**

For safety reason and to prevent component breakdown, always switch off the power before remove and connect the component.

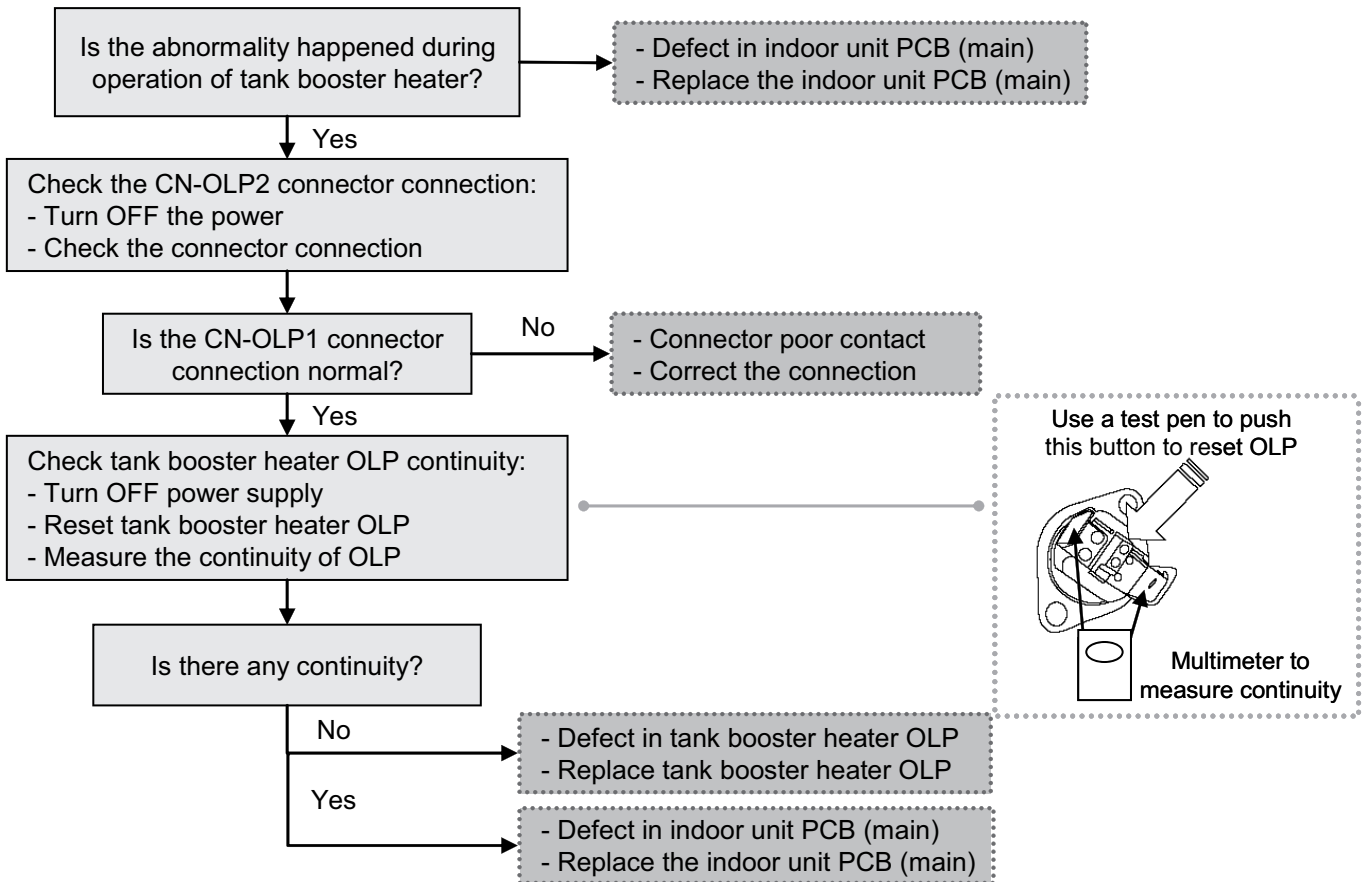

## 16.5.25 Unspecified Voltage between Indoor and Outdoor (H95)

### Malfunction Decision Conditions:

The supply power is detected for its requirement by the indoor/outdoor transmission.

### Malfunction Caused:

- 1 Insufficient power supply.
- 2 Faulty outdoor unit PCB (noise filter/main).

### Troubleshooting:



**Caution**

For safety reason and to prevent component breakdown, always switch off the power before remove and connect the component.

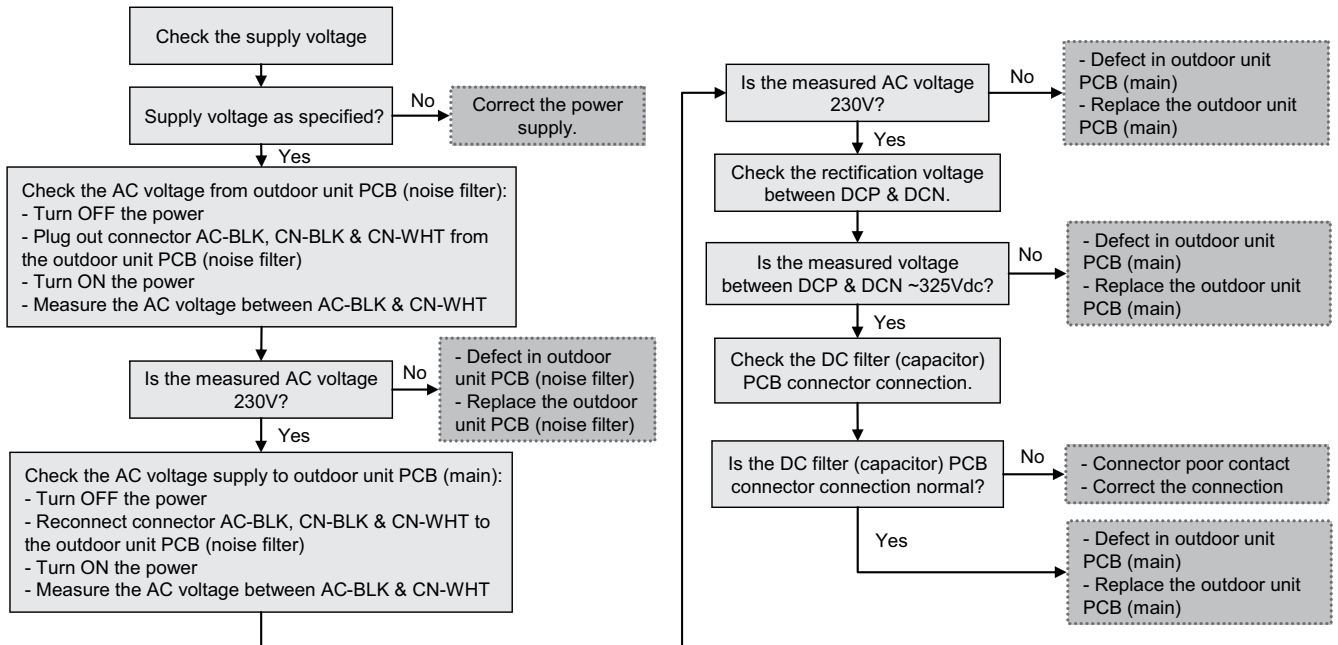

## 16.5.26 Outdoor High Pressure Protection (H98)

### Malfunction Decision Conditions:

During operation of heating, when pressure 4.0 MPa and above is detected by outdoor high pressure sensor.

### Malfunction Caused:

- 1 Faulty water pump.
- 2 Insufficient water flow rate in system.
- 3 Water leak in system.
- 4 2/3 way closed.
- 5 Clogged expansion valve or strainer.
- 6 Excessive refrigerant.
- 7 Faulty outdoor high pressure sensor.
- 8 Faulty outdoor unit PCB (main).

### Troubleshooting:



**Caution**

For safety reason and to prevent component breakdown, always switch off the power before remove and connect the component.

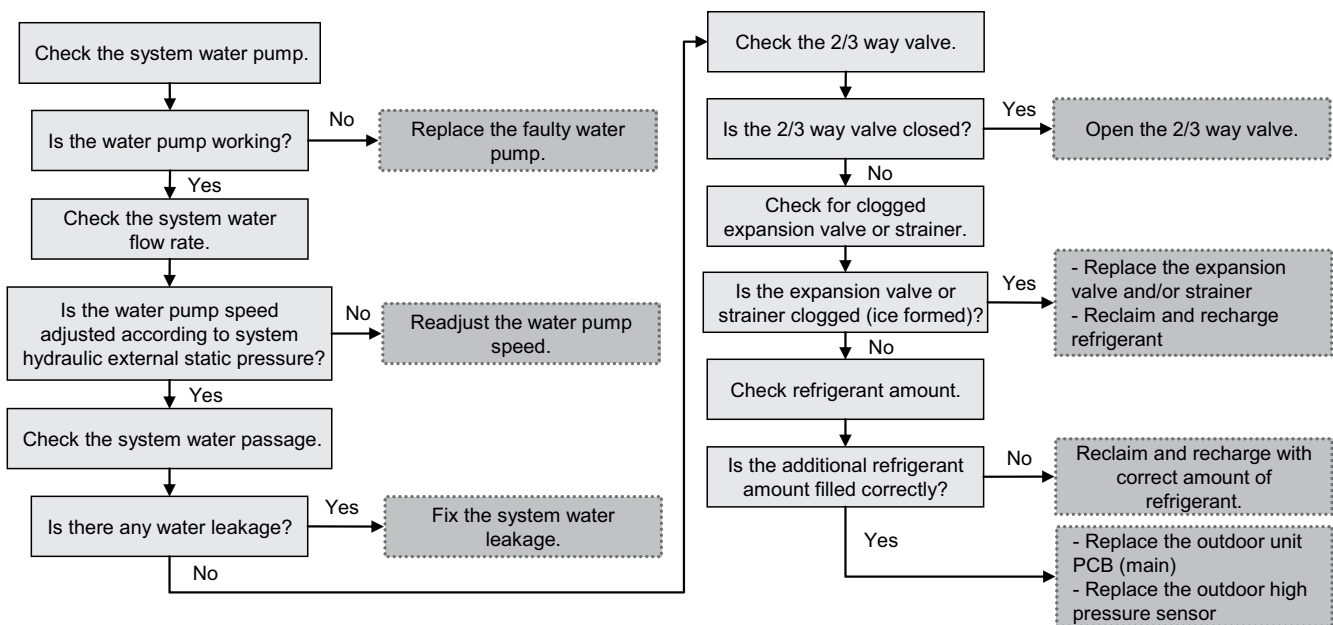

## 16.5.27 Indoor Freeze-up Protection (H99)

### Malfunction Decision Conditions:

During anti-freezing control in cooling operation, when the indoor refrigerant liquid temperature  $< 0^{\circ}\text{C}$ .

### Malfunction Caused:

- 1 Faulty water pump.
- 2 Insufficient water flow rate in system.
- 3 Water leak in system.
- 4 2 way valve partially closed.
- 5 Clogged expansion valve or strainer.
- 6 Refrigerant shortage (refrigerant leakage).
- 7 Faulty indoor refrigerant liquid temperature sensor.
- 8 Faulty indoor unit PCB (main).

### Troubleshooting:



**Caution**

For safety reason and to prevent component breakdown, always switch off the power before remove and connect the component.

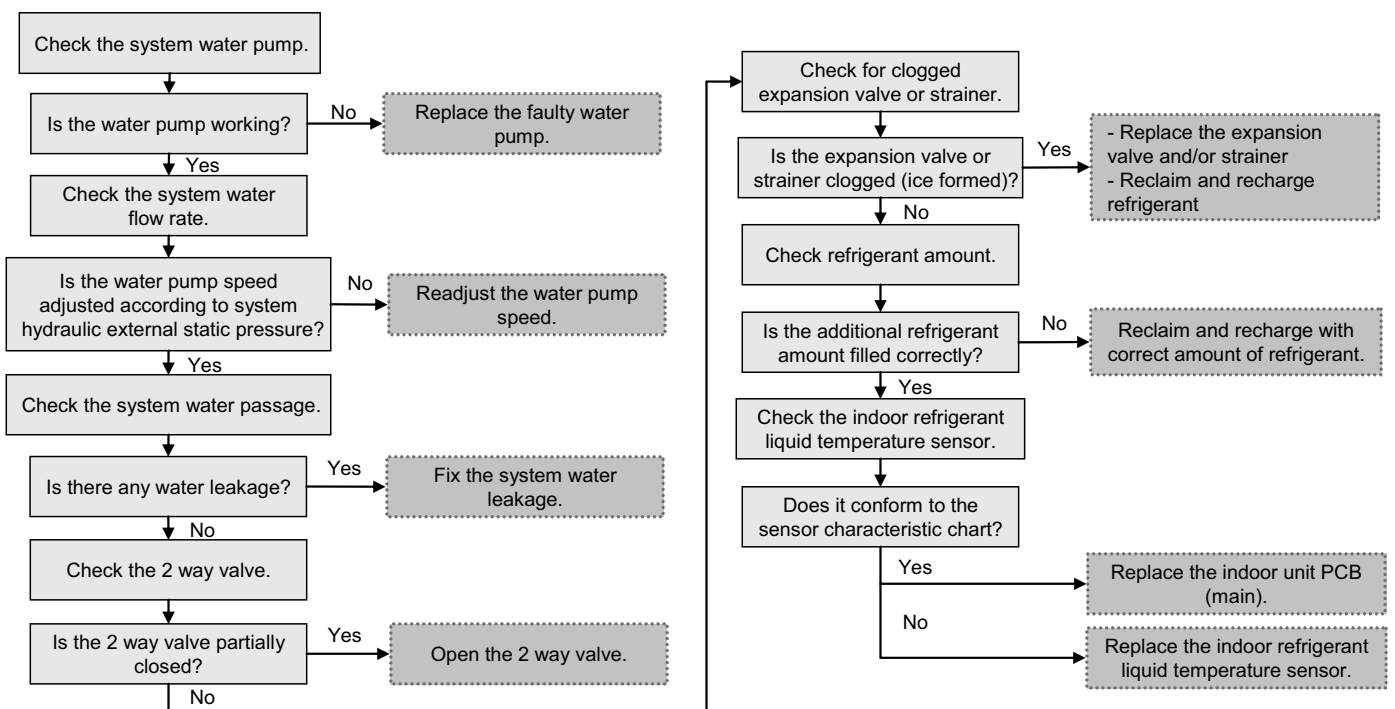

## 16.5.28 Outdoor High Pressure Switch Activate (F12)

### Malfunction Decision Conditions:

During operation of cooling and heating, when pressure 4.5 MPa and above is detected by outdoor high pressure switch.

### Malfunction Caused:

- 1 Dust accumulation on the outdoor unit heat exchanger.
- 2 Air short circuit at outdoor unit.
- 3 Faulty water pump.
- 4 Insufficient water flow rate in system.
- 5 Water leak in system.
- 6 2/3 way valve closed.
- 7 Clogged expansion valve or strainer.
- 8 Excessive refrigerant.
- 9 Faulty outdoor high pressure sensor and switch.
- 10 Faulty outdoor unit PCB.

### Abnormality Judgment:

Continue 4 times in 20 minutes.

### Troubleshooting:



For safety reason and to prevent component breakdown, always switch off the power before remove and connect the component.

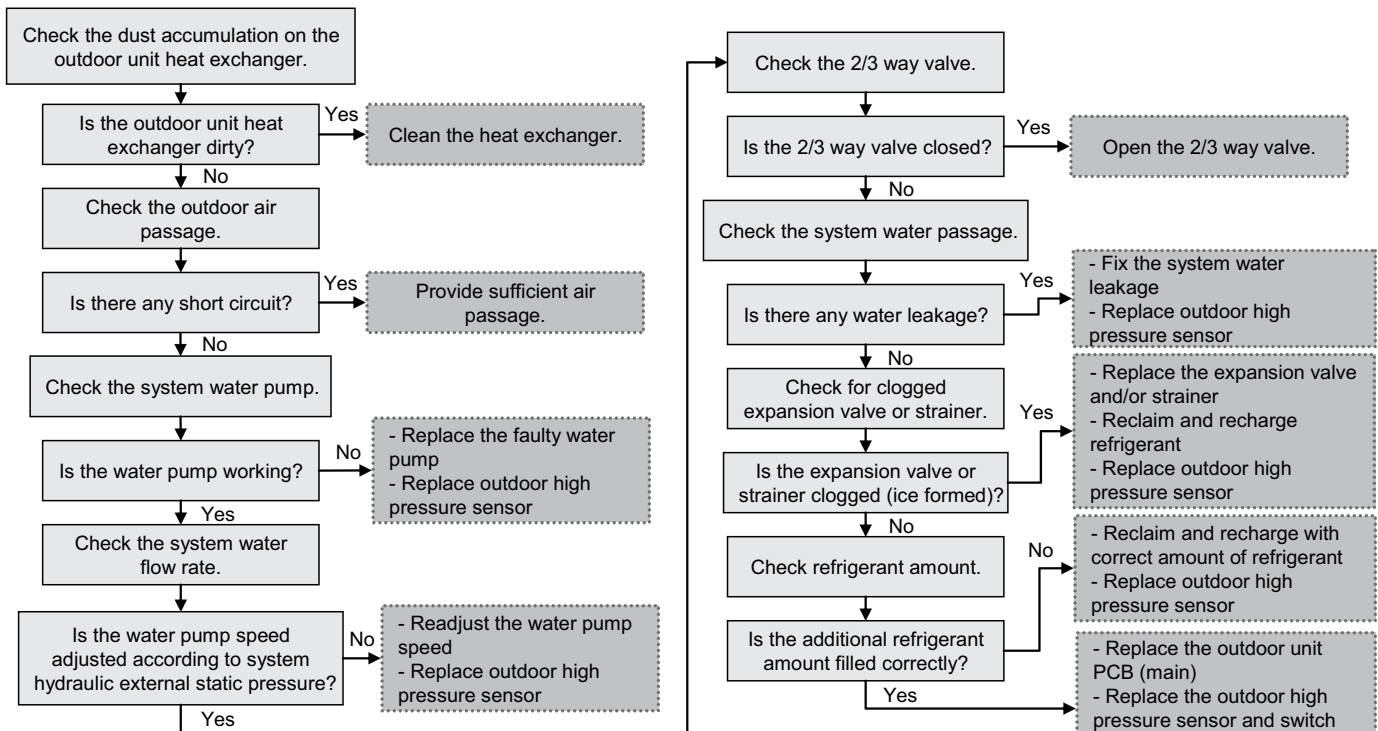

## 16.5.29 Compressor Rotation Failure (F14)

### Malfunction Decision Conditions:

A compressor rotation failure is detected by checking the compressor running condition through the position detection circuit.

### Malfunction Caused:

- 1 Compressor terminal disconnect.
- 2 Faulty outdoor unit PCB (main).
- 3 Faulty compressor.

### Abnormality Judgment:

Continue 4 times in 20 minutes.

## Troubleshooting: Caution

For safety reason and to prevent component breakdown, always switch off the power before remove and connect the component.

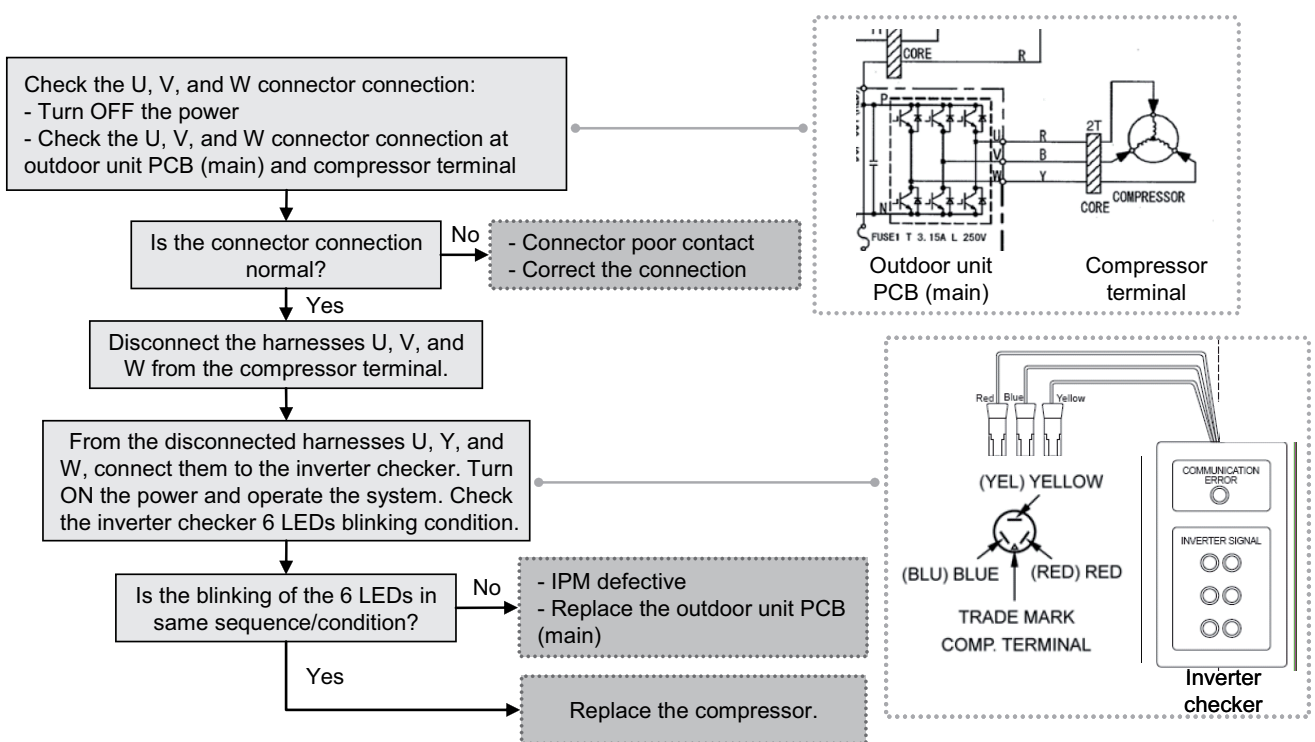

## 16.5.30 Outdoor Fan Motor (DC Motor) Mechanism Locked (F15)

### Malfunction Decision Conditions:

The rotation speed detected by the Hall IC of the fan motor during fan motor operation is used to determine abnormal fan motor (feedback of rotation > 2550 rpm or < 50 rpm).

### Malfunction Caused:

- 1 Operation stop due to short circuit inside the fan motor winding.
- 2 Operation stop due to breaking of wire inside the fan motor.
- 3 Operation stop due to breaking of fan motor lead wires.
- 4 Operation stop due to fan motor Hall IC malfunction.
- 5 Operation error due to faulty outdoor unit PCB.

### Abnormality Judgment:

Continue 2 times in 30 minutes.

### Troubleshooting:



**Caution**

For safety reason and to prevent component breakdown, always switch off the power before remove and connect the component.

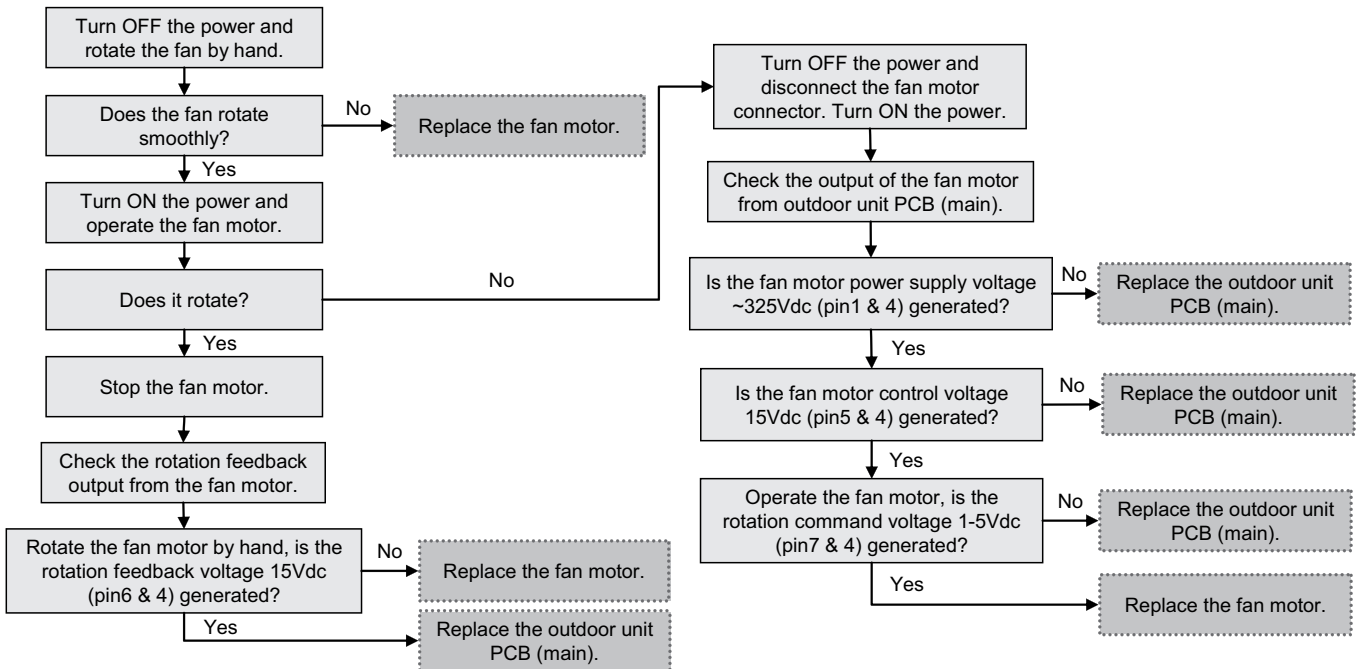



### 16.5.31 Input Over Current Detection (F16)

**Malfunction Decision Conditions:**

During operation of cooling and heating, when outdoor current above 11.8 A (UX09HE5, UX12HE5) is detected by the current transformer (CT) in the outdoor unit PCB.

**Malfunction Caused:**

- 1 Excessive refrigerant.
- 2 Faulty outdoor unit PCB (main).

**Abnormality Judgment:**

Continue 3 times in 20 minutes.

**Troubleshooting:**



For safety reason and to prevent component breakdown, always switch off the power before remove and connect the component.

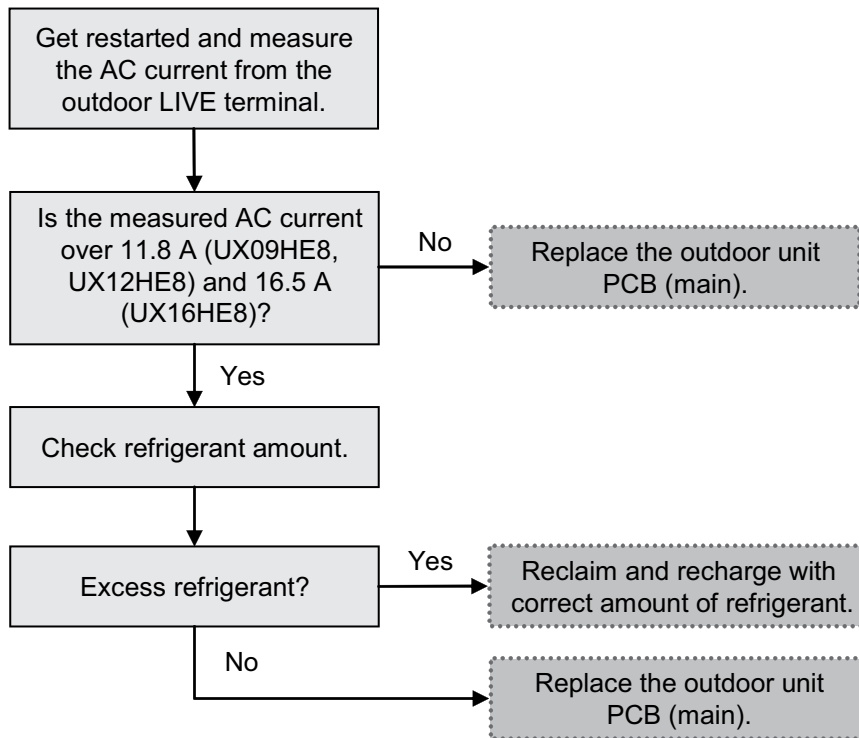

## 16.5.32 Compressor Overheating (F20)

### Malfunction Decision Conditions:

During operation of cooling and heating, when temperature above 107°C is detected by the compressor tank temperature sensor.

### Malfunction Caused:

- 1 Faulty compressor tank temperature sensor.
- 2 2/3 way valve closed.
- 3 Refrigerant shortage (refrigerant leakage).
- 4 Clogged expansion valve or strainer.
- 5 Faulty outdoor unit PCB (main).
- 6 Faulty compressor.

### Abnormality Judgment:

Continue 4 times in 30 minutes.

### Troubleshooting:



For safety reason and to prevent component breakdown, always switch off the power before remove and connect the component.

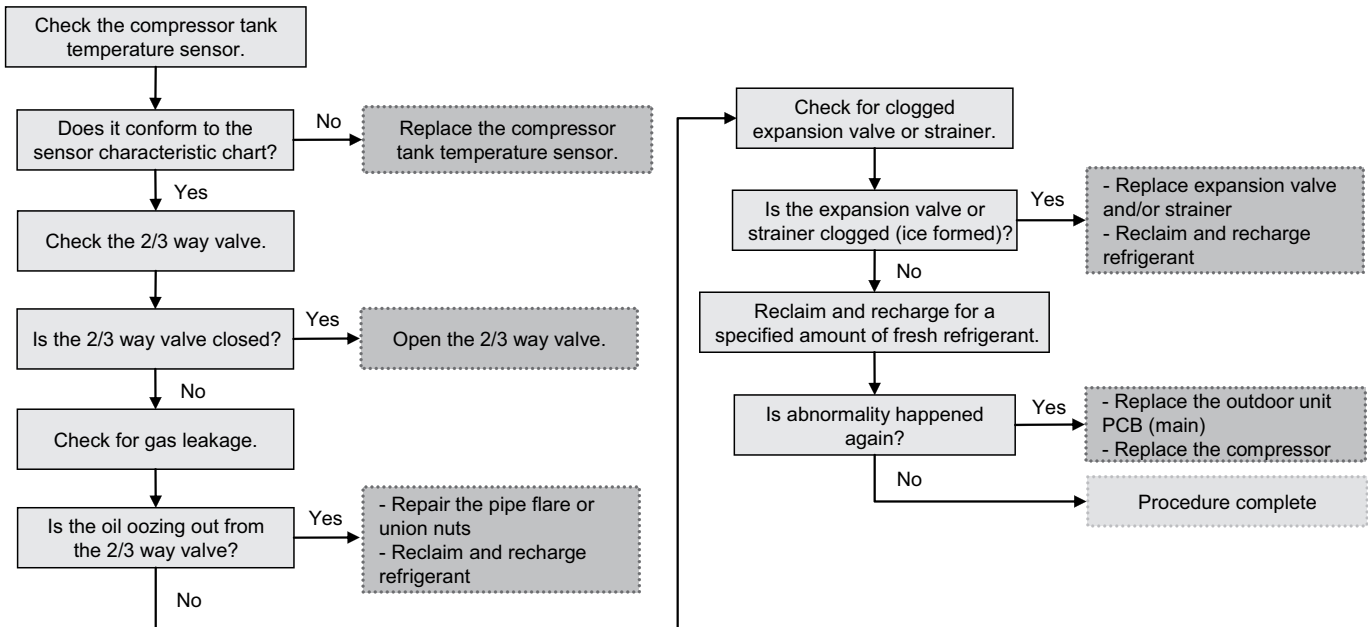

### 16.5.33 IPM Overheating (F22)

**Malfunction Decision Conditions:**

During operation of cooling and heating, when temperature 95°C is detected by the outdoor IPM temperature sensor.

**Malfunction Caused:**

- 1 Faulty outdoor unit fan motor.
- 2 Faulty outdoor unit PCB (main).

**Abnormality Judgment:**

Continue 3 times in 30 minutes.

**Troubleshooting:**



For safety reason and to prevent component breakdown, always switch off the power before remove and connect the component.

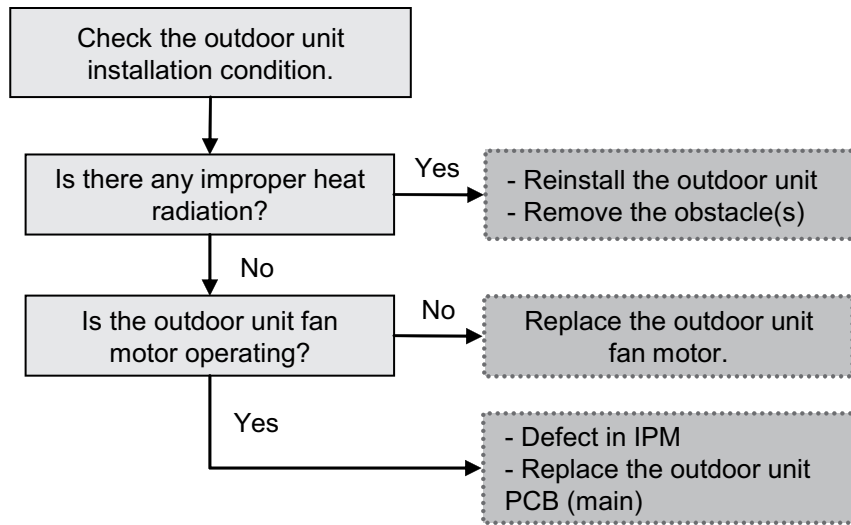

## 16.5.34 Output Over Current Detection (F23)

### Malfunction Decision Conditions:

During operation of cooling and heating, when outdoor DC current is above 34 A (UX09,12HE5) is detected by the IPM DC Peak sensing circuitry in the outdoor unit PCB (main).

### Malfunction Caused:

- 1 Faulty outdoor unit PCB (main).
- 2 Faulty compressor.

### Abnormality Judgment:

Continue for 7 times.

## Troubleshooting:



**Caution**

For safety reason and to prevent component breakdown, always switch off the power before remove and connect the component.

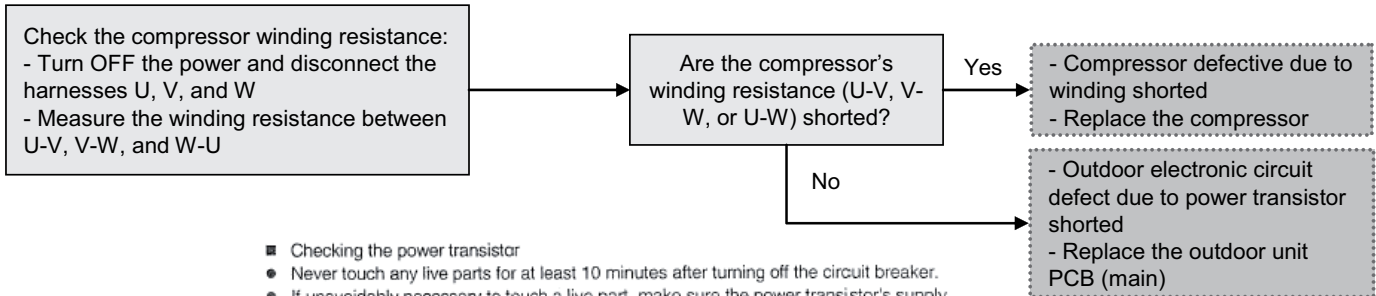

- Checking the power transistor
- Never touch any live parts for at least 10 minutes after turning off the circuit breaker.
- If unavoidably necessary to touch a live part, make sure the power transistor's supply voltage is below 50 V using the tester.
- For the UVW, make measurements at the Faston terminal on the board or the relay connector.

Tester's negative terminal	Power transistor (+)	UVW	Power transistor (-)	UVW
Tester's positive terminal	UVW	Power transistor (+)	UVW	Power transistor (-)
Normal resistance	Several kohms to several Mohms			
Abnormal resistance	0 or ∞			

## 16.5.35 Refrigeration Cycle Abnormality (F24)

### Malfunction Decision Conditions:

- 1 During operation of cooling and heating, compressor frequency > Frated.
- 2 During operation of cooling and heating, running current:  $0.65 \text{ A} < I < 1.65 \text{ A}$ .
- 3 During operation of cooling, water inlet temperature - indoor refrigerant liquid temperature  $< 5^\circ\text{C}$ .
- 4 During operation of heating, indoor refrigerant liquid temperature - water inlet temperature  $< 5^\circ\text{C}$ .

### Malfunction Caused:

- 1 Faulty water inlet or indoor refrigerant liquid temperature sensors.
- 2 2/3 way valve closed.
- 3 Refrigerant shortage (refrigerant leakage).
- 4 Clogged expansion valve or strainer.
- 5 Faulty outdoor unit PCB (main).
- 6 Poor compression of compressor.

### Abnormality Judgment:

Continue 2 times in 20 minutes.

### Troubleshooting:



**Caution**

For safety reason and to prevent component breakdown, always switch off the power before remove and connect the component.

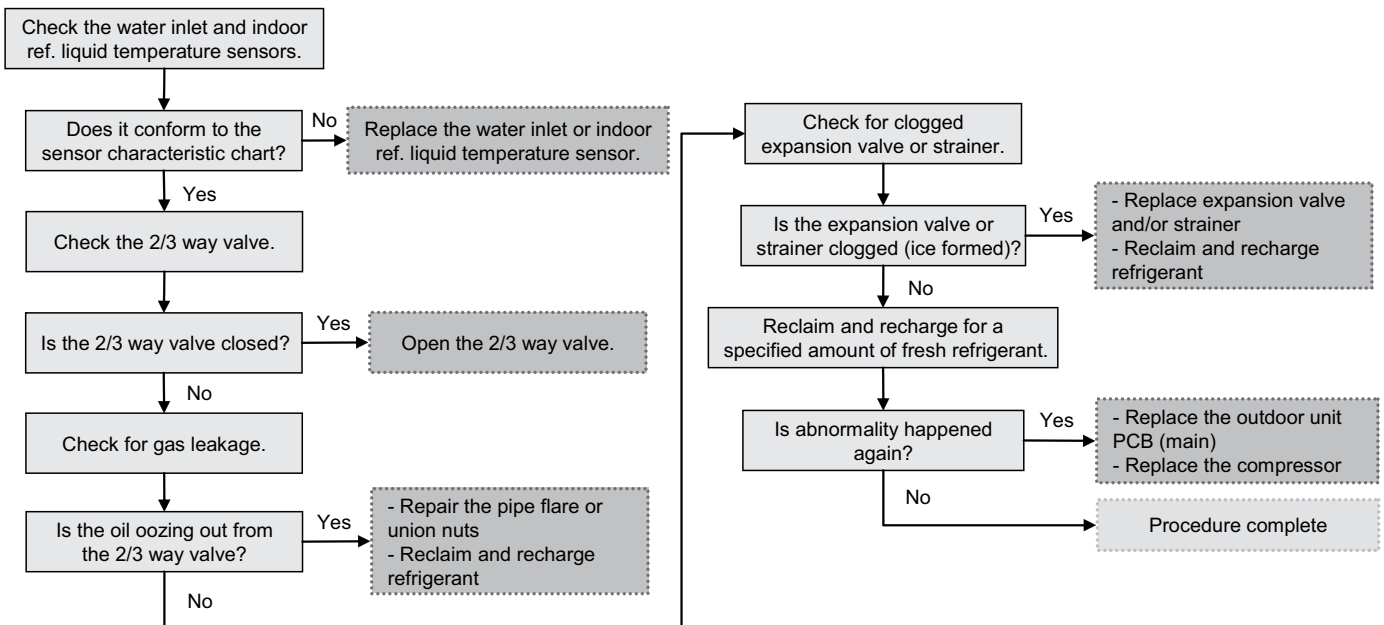

## 16.5.36 Four Way Valve Abnormality (F25)

### Malfunction Decision Conditions:

- 1 During heating operation, when the indoor pipe temperature of thermostat ON indoor unit < 0°C.
- 2 During cooling operation, when the indoor pipe temperature of thermostat ON indoor unit > 45°C.

### Malfunction Caused:

- 1 Faulty sensor.
- 2 Faulty connector connection.
- 3 Faulty outdoor unit PCB (noise filter/main).
- 4 Faulty four way valve.

### Abnormality Judgment:

Continue 4 times in 30 minutes.

## Troubleshooting:



For safety reason and to prevent component breakdown, always switch off the power before remove and connect the component.

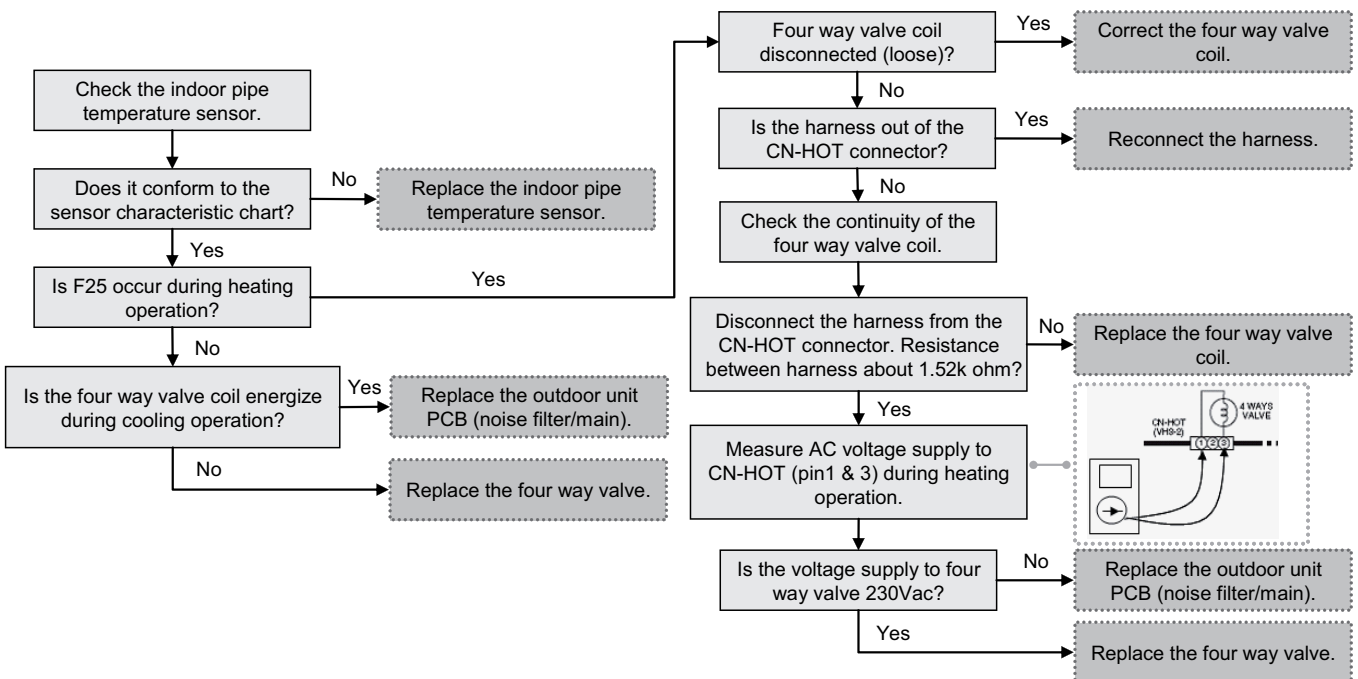

### 16.5.37 Outdoor High Pressure Switch Abnormal (F27)

**Malfunction Decision Conditions:**

During compressor stop, and outdoor high pressure switch is remain opened.

**Malfunction Caused:**

- 1 Faulty connector connection.
- 2 Faulty switch.
- 3 Faulty outdoor unit PCB (main).

**Abnormality Judgment:**

Continue for 1 minute.

**Troubleshooting:**



For safety reason and to prevent component breakdown, always switch off the power before remove and connect the component.

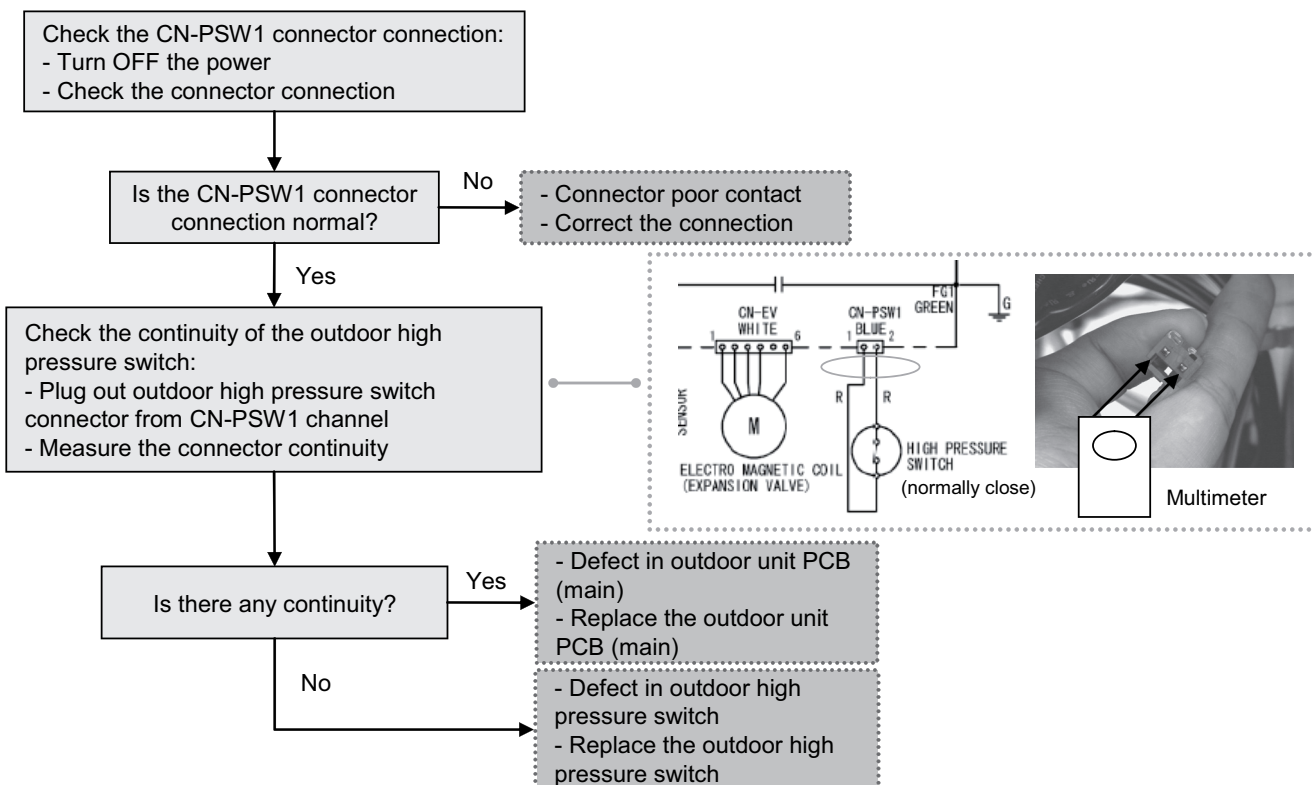

## 16.5.38 Low Discharge Superheat (F29)

### Malfunction Decision Conditions:

During startup and operation of cooling and heating, the temperatures detected by the outdoor pipe temperature sensor are used to determine sensor error.

### Malfunction Caused:

- 1 Faulty connector connection.
- 2 Faulty sensor.
- 3 Faulty outdoor unit PCB (main).
- 4 Faulty High Pressure Switch
- 5 Refrigerant shortage (refrigerant leakage).

### Abnormality Judgment:

1 times occurrence within 2550 minutes.

### Troubleshooting:



**Caution**

For safety reason and to prevent component breakdown, always switch off the power before remove and connect the component.

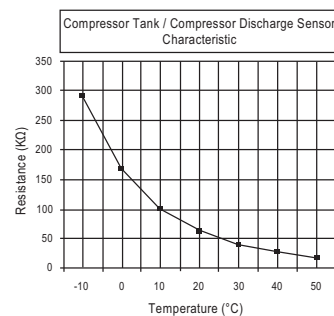
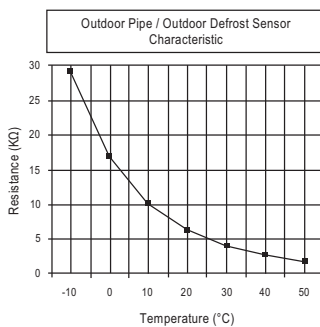
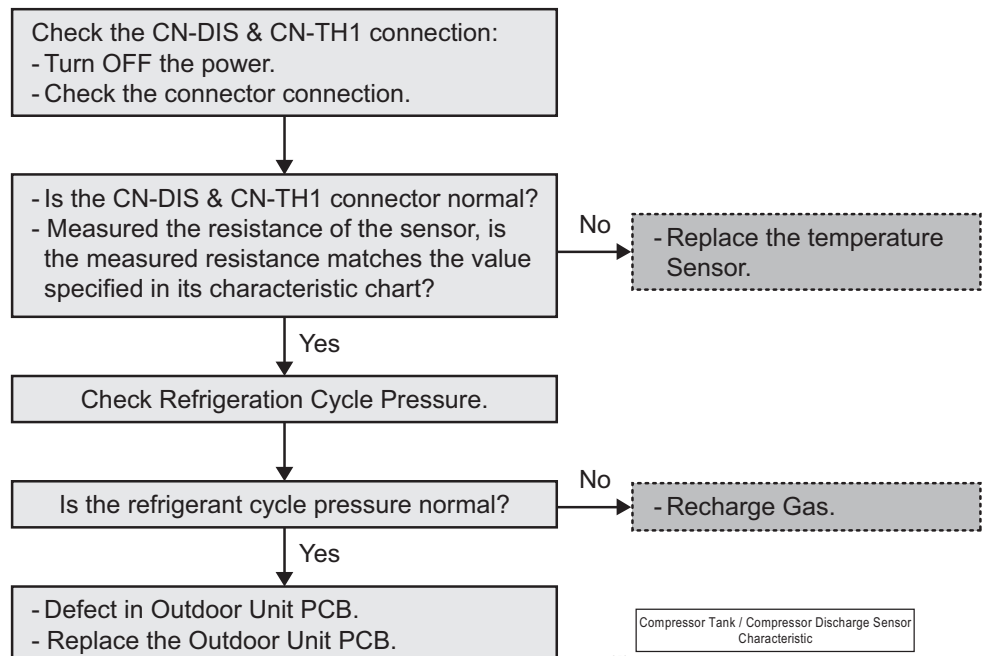



### 16.5.39 Indoor Water Outlet Temperature Sensor 2 Abnormality (F30)

**Malfunction Decision Conditions:**

During startup and operation of cooling and heating, the temperatures detected by the indoor water outlet temperature sensor 2 are used to determine sensor error.

**Malfunction Caused:**

- 1 Faulty connector connection.
- 2 Faulty sensor.
- 3 Faulty indoor unit PCB.

**Abnormality Judgment:**

Continue for 5 seconds.

**Troubleshooting:**



**Caution**

For safety reason and to prevent component breakdown, always switch off the power before remove and connect the component.

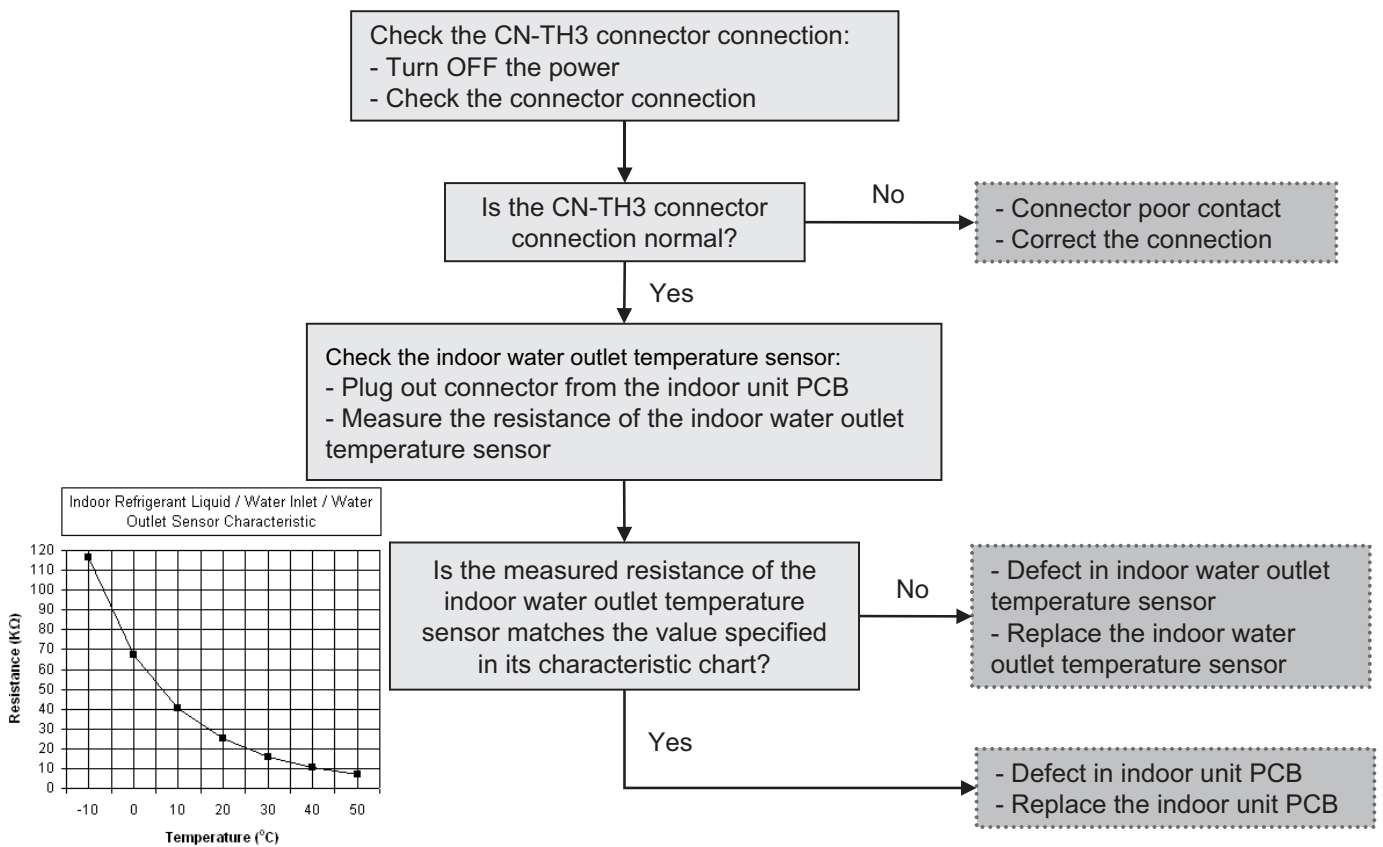

## 16.5.40 Abnormal Internal Thermostat (F32)

### Malfunction Decision Condition:

- When Zone 1 or Zone 2 room sensor select use internal thermostat **AND**
- 1 Internal thermostat open circuit: less than °C continuously for 5 seconds **OR**
  - 2 Internal thermostat short circuit: 127°C or more continuously for 5 seconds.

### Malfunction Caused:

- 1 Faulty wiring connection
- 2 Faulty Indoor PCB
- 3 Faulty remote controller

### Abnormality Judgment:

Continue for 5 seconds



### Caution

For safety reason and to prevent component breakdown, always switch off the power before remove and connect the component.

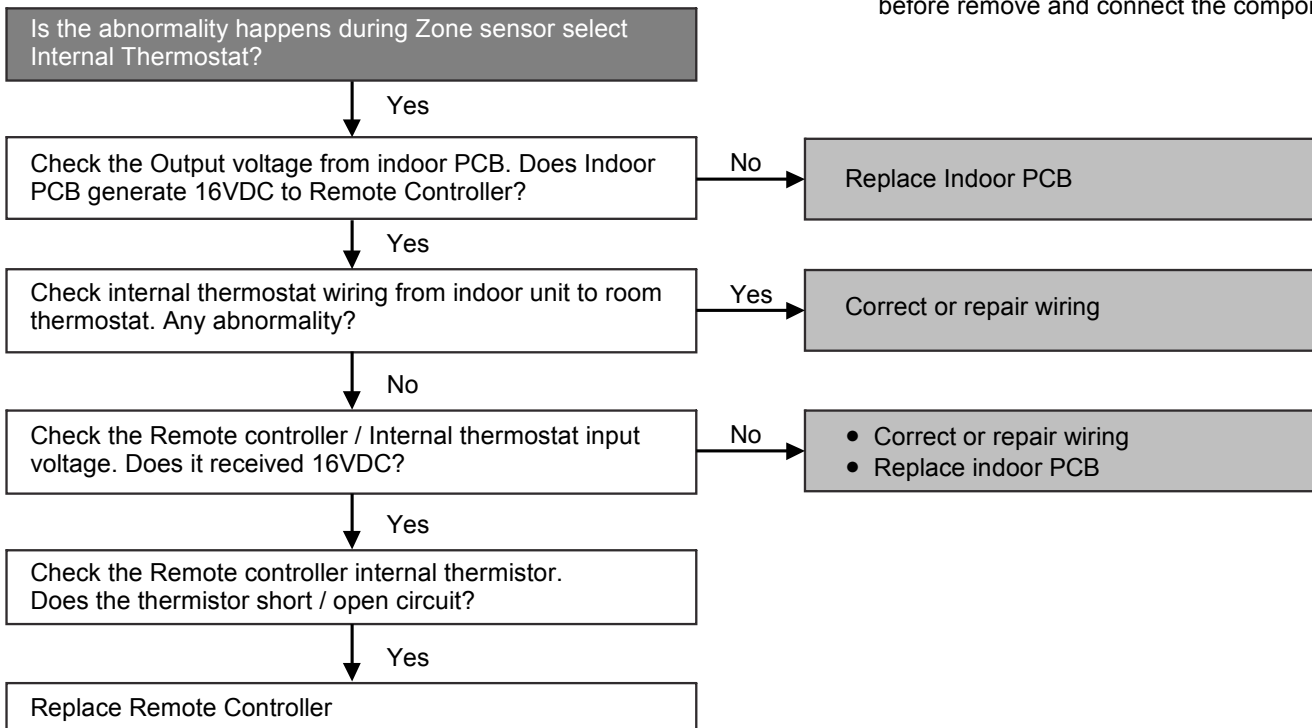

## 16.5.41 Outdoor Air Temperature Sensor Abnormality (F36)

### Malfunction Decision Conditions:

During startup and operation of cooling and heating, the temperatures detected by the outdoor air temperature sensor are used to determine sensor error.

### Malfunction Caused:

- 1 Faulty connector connection.
- 2 Faulty sensor.
- 3 Faulty outdoor unit PCB (main).

### Abnormality Judgment:

Continue for 5 seconds.

### Troubleshooting:



**Caution**

For safety reason and to prevent component breakdown, always switch off the power before remove and connect the component.

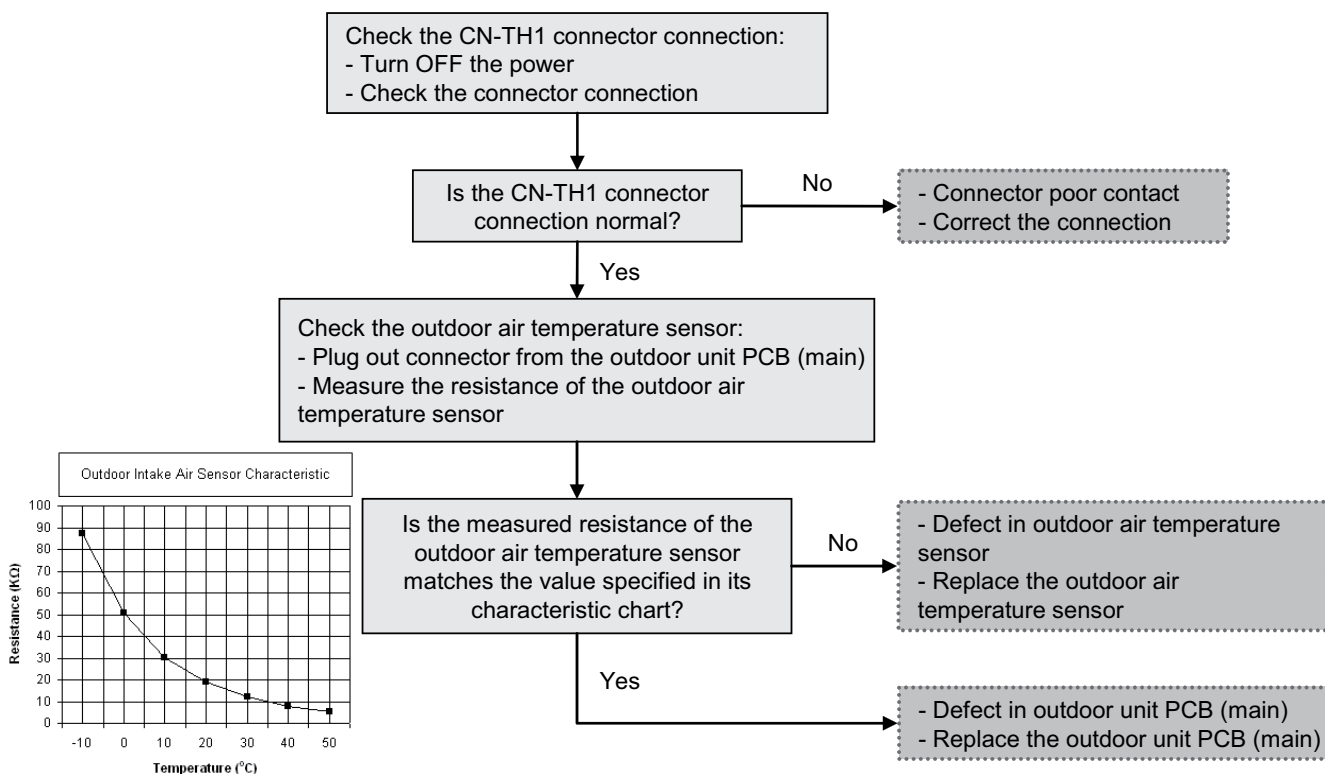

## 16.5.42 Indoor Water Inlet Temperature Sensor Abnormality (F37)

### Malfunction Decision Conditions:

During startup and operation of cooling and heating, the temperatures detected by the indoor water inlet temperature sensor are used to determine sensor error.

### Malfunction Caused:

- 1 Faulty connector connection.
- 2 Faulty sensor.
- 3 Faulty indoor unit PCB (main).

### Abnormality Judgment:

Continue for 5 seconds.

### Troubleshooting:



**Caution**

For safety reason and to prevent component breakdown, always switch off the power before remove and connect the component.

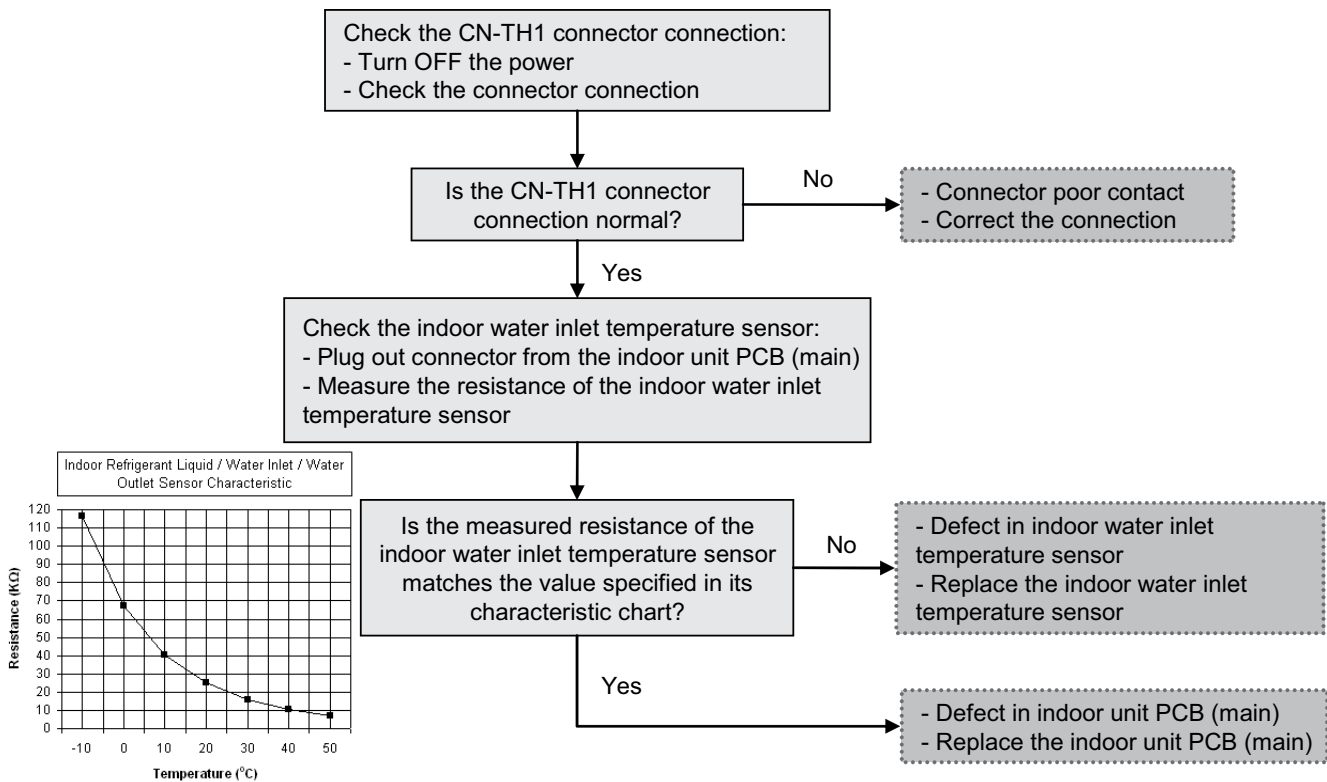

## 16.5.43 Outdoor Discharge Pipe Temperature Sensor Abnormality (F40)

### Malfunction Decision Conditions:

During startup and operation of cooling and heating, the temperatures detected by the outdoor discharge pipe temperature sensor are used to determine sensor error.

### Malfunction Caused:

- 1 Faulty connector connection.
- 2 Faulty sensor.
- 3 Faulty outdoor unit PCB (main).

### Abnormality Judgment:

Continue for 5 seconds.

### Troubleshooting:



**Caution**

For safety reason and to prevent component breakdown, always switch off the power before remove and connect the component.

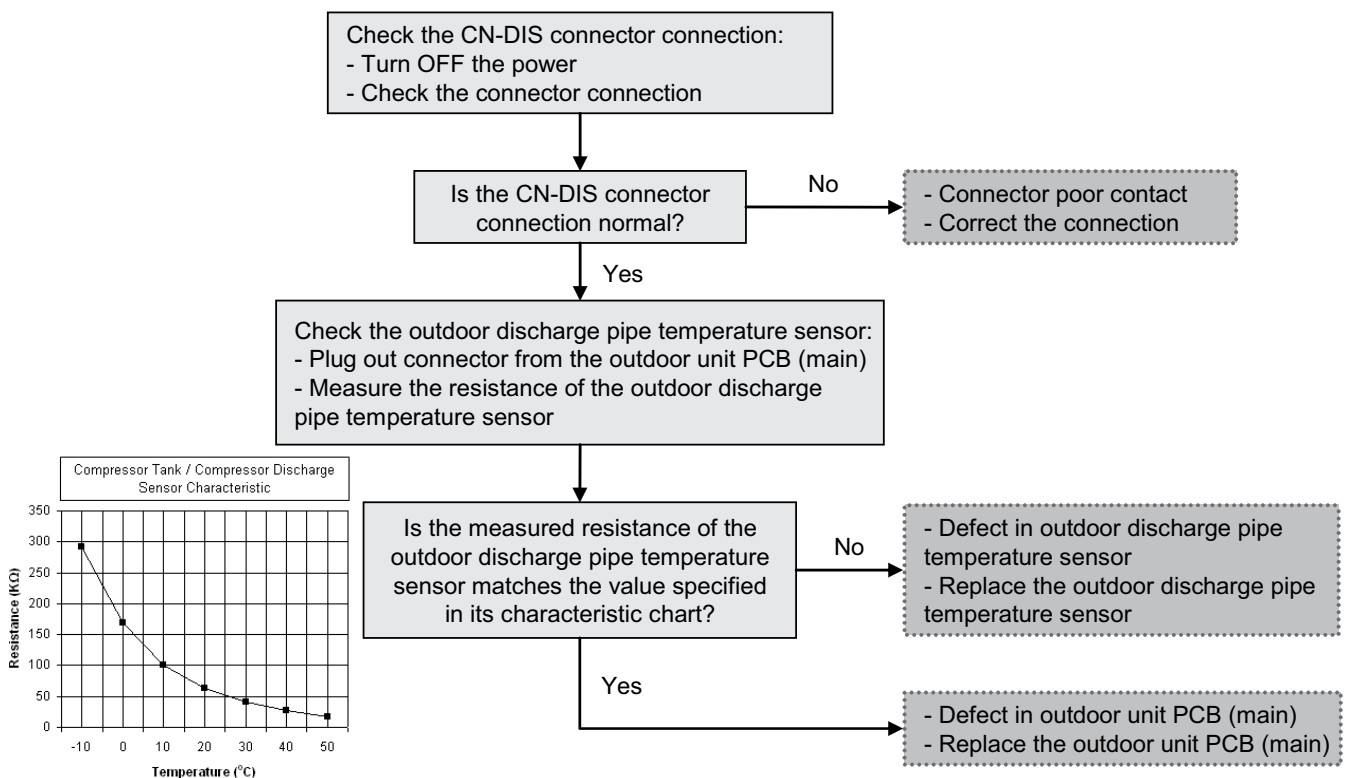

## 16.5.44 Power Factor Correction (PFC) Abnormality (F41)

### Malfunction Decision Conditions:

During operation of cooling and heating, when the PFC protection circuitry in the outdoor unit PCB (main) senses abnormal high DC voltage level.

### Malfunction Caused:

- 1 Power supply surge.
- 2 Compressor windings not uniform.
- 3 Faulty outdoor unit PCB (main).

### Abnormality Judgment:

Continue 4 times in 10 minutes.

### Troubleshooting:



**Caution**

For safety reason and to prevent component breakdown, always switch off the power before remove and connect the component.

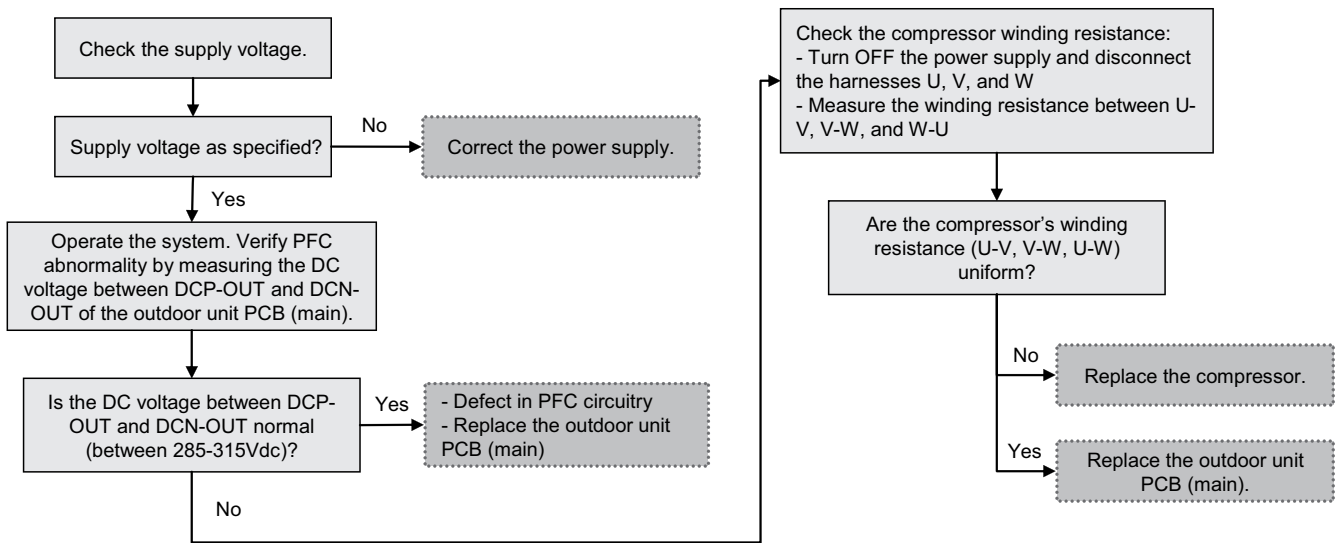

## 16.5.45 Outdoor Pipe Temperature Sensor Abnormality (F42)

### Malfunction Decision Conditions:

During startup and operation of cooling and heating, the temperatures detected by the outdoor pipe temperature sensor are used to determine sensor error.

### Malfunction Caused:

- 1 Faulty connector connection.
- 2 Faulty sensor.
- 3 Faulty outdoor unit PCB (main).

### Abnormality Judgment:

Continue for 5 seconds.

### Troubleshooting:



**Caution**

For safety reason and to prevent component breakdown, always switch off the power before remove and connect the component.

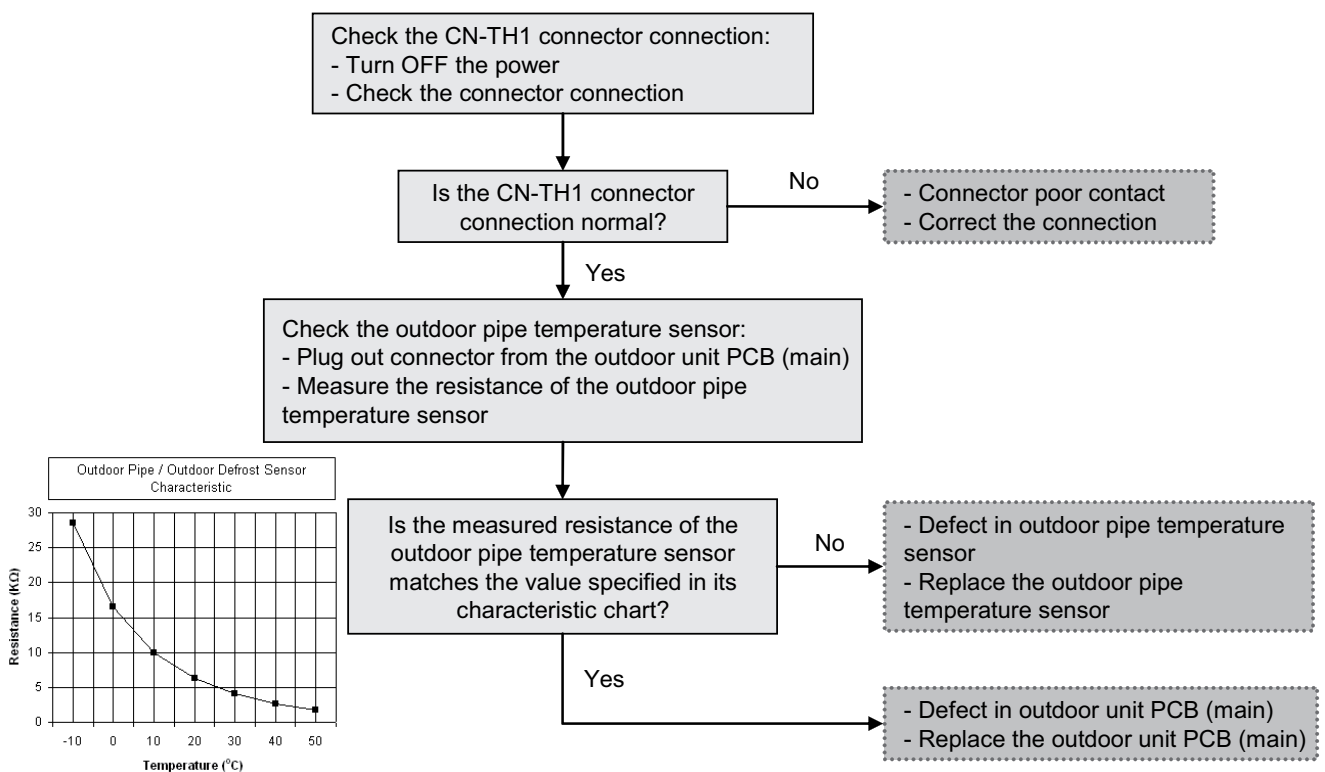

## 16.5.46 Outdoor Defrost Temperature Sensor Abnormality (F43)

### Malfunction Decision Conditions:

During startup and operation of cooling and heating, the temperatures detected by the outdoor defrost temperature sensor are used to determine sensor error.

### Malfunction Caused:

- 1 Faulty connector connection.
- 2 Faulty sensor.
- 3 Faulty outdoor unit PCB (main).

### Abnormality Judgment:

Continue for 5 seconds.

### Troubleshooting:



**Caution**

For safety reason and to prevent component breakdown, always switch off the power before remove and connect the component.

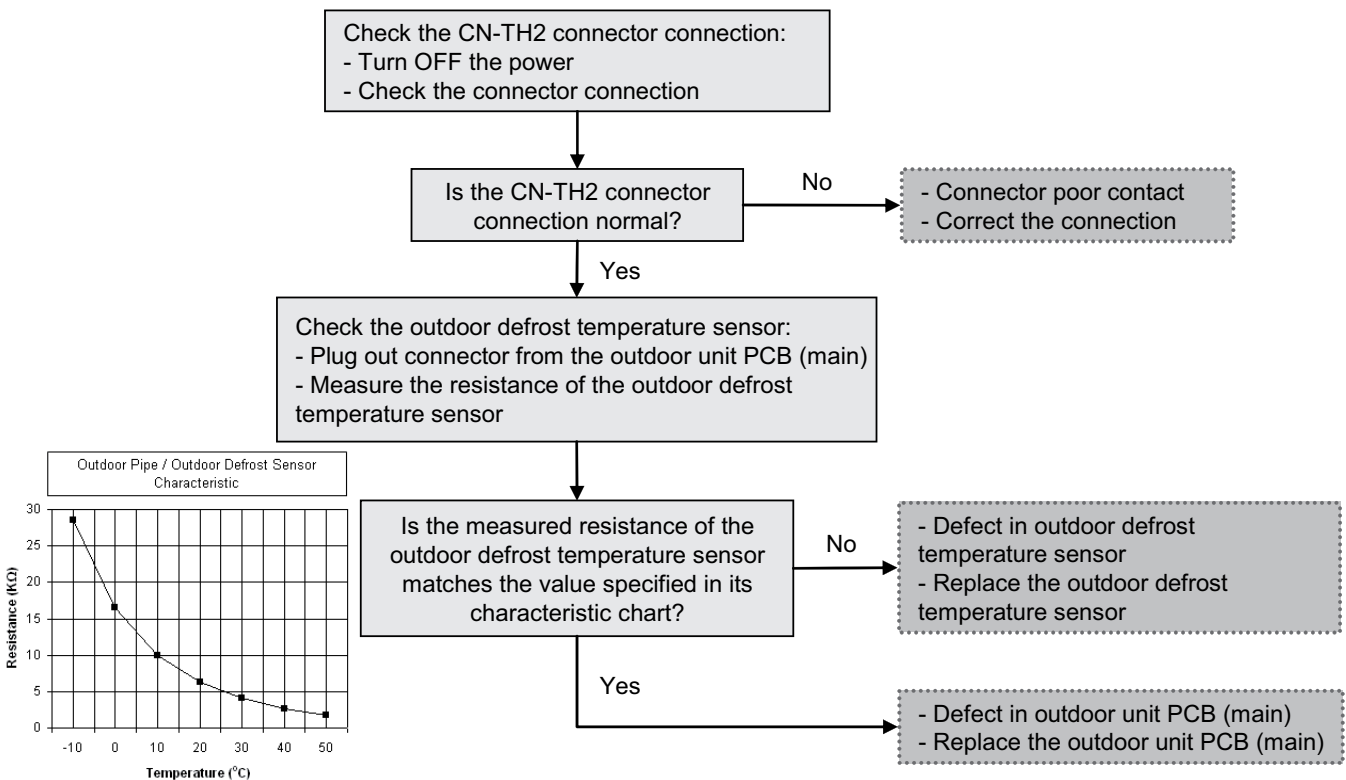



## 16.5.47 Indoor Water Outlet Temperature Sensor Abnormality (F45)

### Malfunction Decision Conditions:

During startup and operation of cooling and heating, the temperatures detected by the indoor water outlet temperature sensor are used to determine sensor errors.

### Malfunction Caused:

- 1 Faulty connector connection.
- 2 Faulty sensor.
- 3 Faulty indoor unit PCB (main).

### Abnormality Judgment:

Continue for 5 seconds.

### Troubleshooting: **Caution**

For safety reason and to prevent component breakdown, always switch off the power before remove and connect the component.

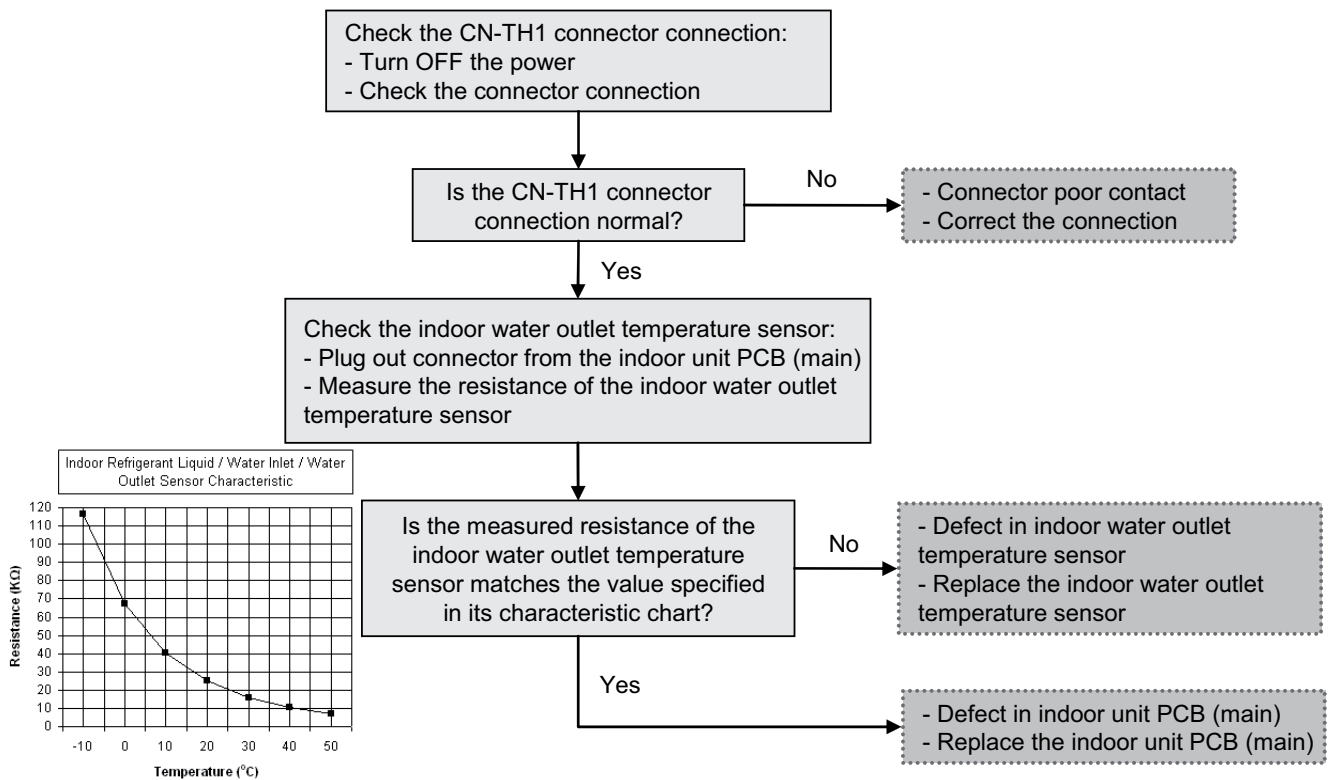

## 16.5.48 Outdoor Current Transformer Open Circuit (F46)

### Malfunction Decision Conditions:

A current transformer (CT) open circuit is detected by checking the compressor running frequency ( $\geq$  rated frequency) and CT detected input current ( $< 0.65$  A) for continuously 20 seconds.

### Malfunction Caused:

- 1 CT defective.
- 2 Faulty outdoor unit PCB (main).
- 3 Compressor defective (low compression).

### Abnormality Judgment:

Continue 3 times in 20 minutes.

## Troubleshooting:



For safety reason and to prevent component breakdown, always switch off the power before remove and connect the component.

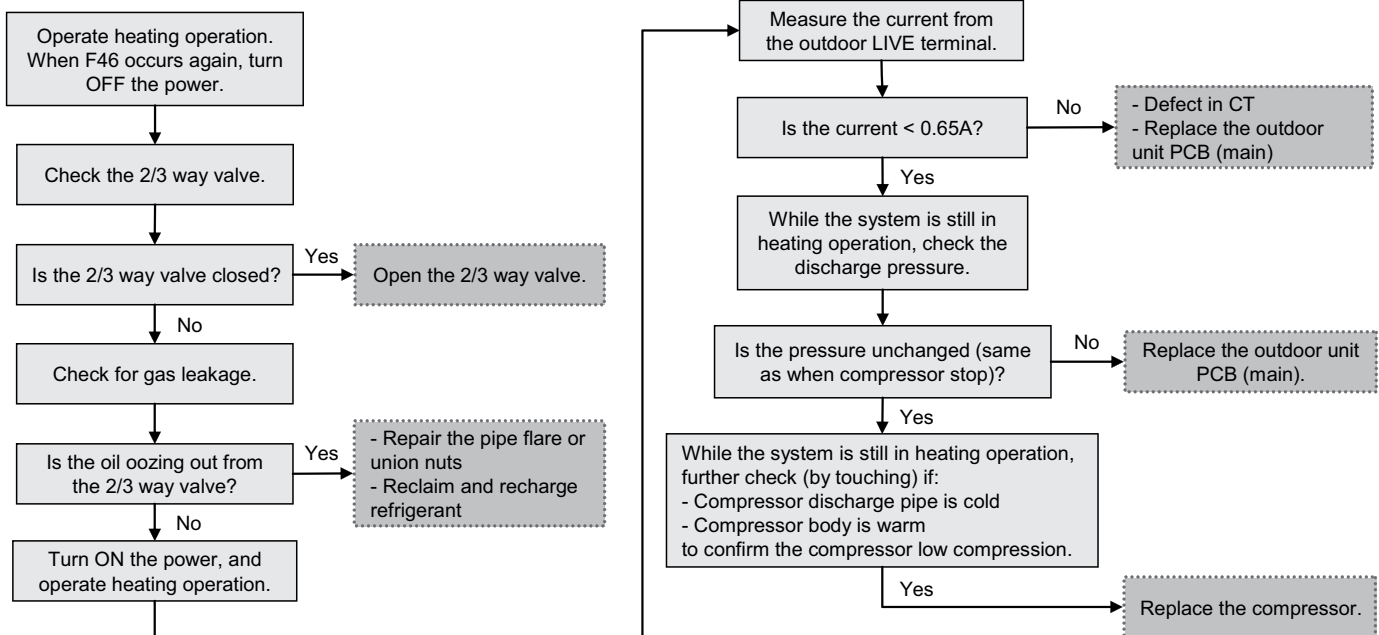

## 16.5.49 Outdoor Eva Outlet Temperature Sensor Abnormality (F48)

### Malfunction Decision Condition:

During startup and operation of cooling and heating, the temperature detected by outdoor Eva outlet temperature sensor are used to determine sensor error

### Malfunction Caused:

- 1 Faulty connector connection
- 2 Faulty sensor
- 3 Faulty Indoor PCB

### Abnormality Judgment:

Continue for 5 seconds



### Caution

For safety reason and to prevent component breakdown, always switch off the power before remove and connect the component.

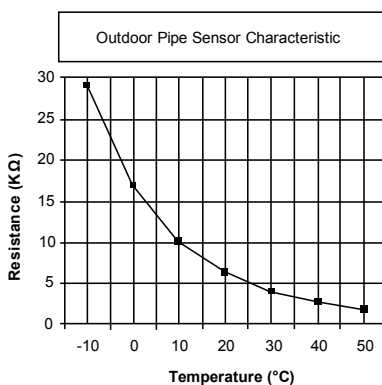
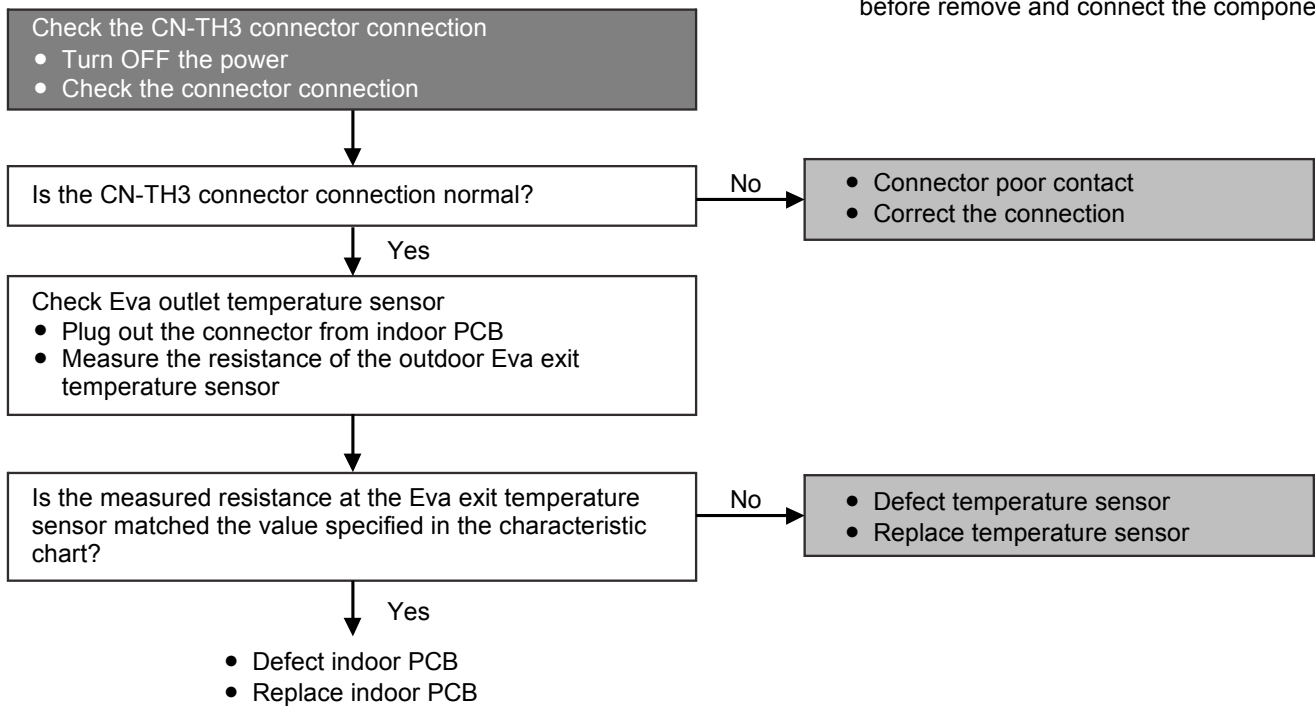

## 16.5.50 Outdoor Bypass Outlet Temperature Sensor Abnormality (F49)

### Malfunction Decision Condition:

During startup and operation of cooling and heating, the temperature detected by outdoor Bypass Outlet temperature sensor are used to determine sensor error

### Malfunction Caused:

- 1 Faulty connector connection
- 2 Faulty sensor
- 3 Faulty Indoor PCB

### Abnormality Judgment:

Continue for 5 seconds



### Caution

For safety reason and to prevent component breakdown, always switch off the power before remove and connect the component.

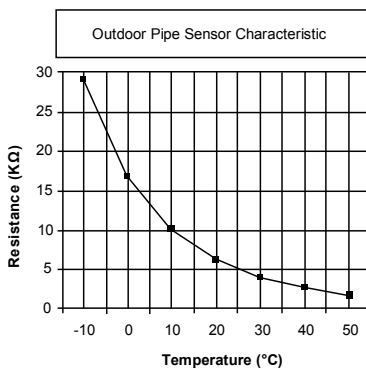
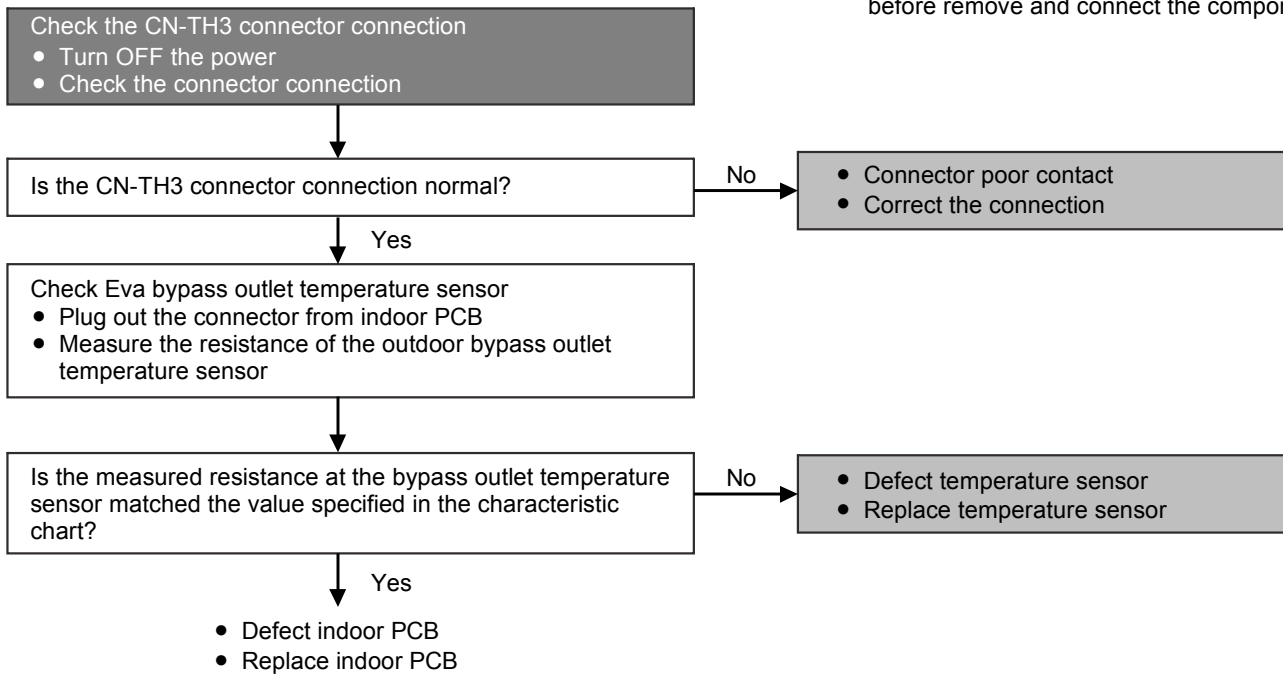

## 16.5.51 Outdoor Bypass Outlet Temperature Sensor (F49)

### Malfunction Decision Conditions:

During start up and operation of Cooling and Heating, the temperature detected by outdoor bypass sensor is used to determine sensor error.

### Malfunction Caused:

- 1 Faulty connector connection
- 2 Faulty sensor
- 3 Faulty outdoor unit PCB (main)

### Abnormality Judgment:

Continuous for 5 seconds

### Troubleshooting:



**Caution**

For safety reason and to prevent component breakdown, always switch off the power before remove and connect the component.

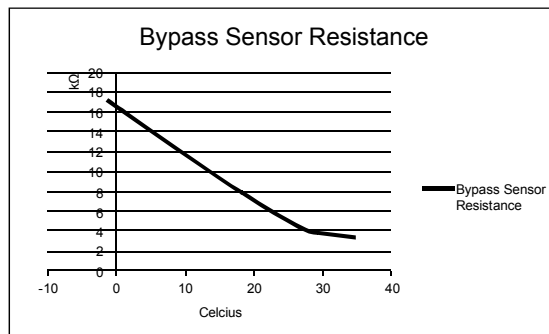
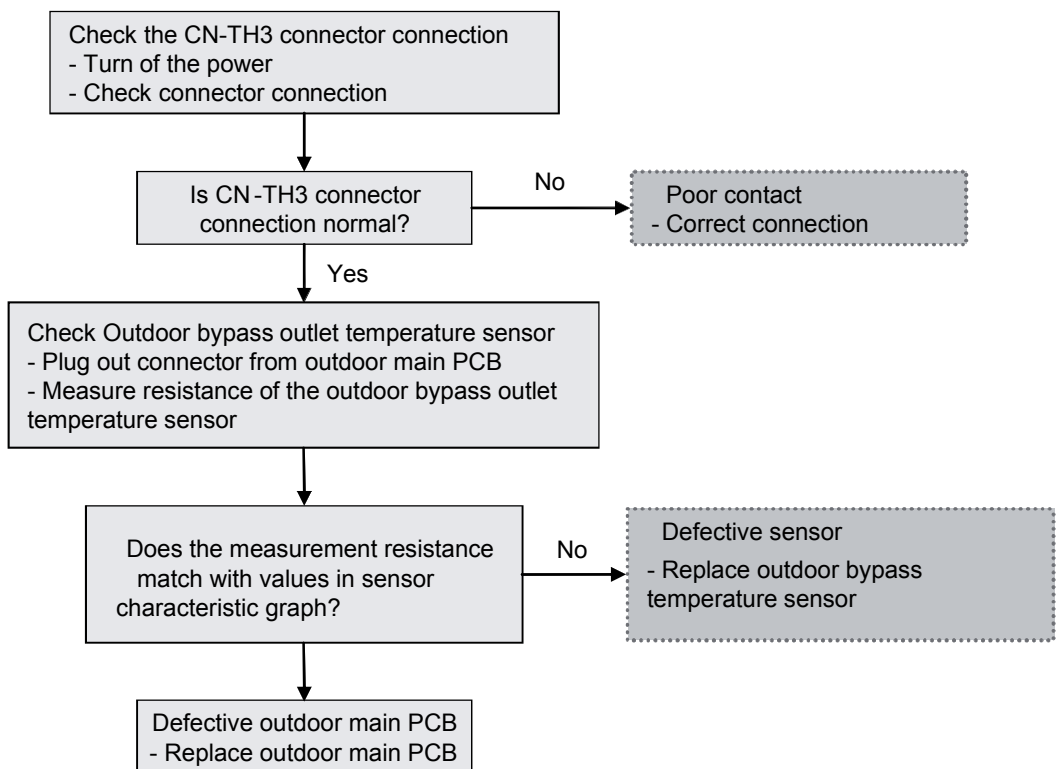

## 16.5.52 Cooling High Pressure Overload Protection (F95)

### Malfunction Decision Conditions:

During operation of cooling, when pressure 4.0 MPa and above is detected by outdoor high pressure sensor.

### Malfunction Caused:

- 1 Dust accumulation in the outdoor unit heat exchanger.
- 2 Air short circuit at outdoor unit.
- 3 2 way valve closed.
- 4 Faulty outdoor unit fan motor.
- 5 Clogged expansion valve or strainer.
- 6 Excessive refrigerant.
- 7 Faulty outdoor high pressure sensor.
- 8 Faulty outdoor unit PCB (main).

### Troubleshooting:



For safety reason and to prevent component breakdown, always switch off the power before remove and connect the component.

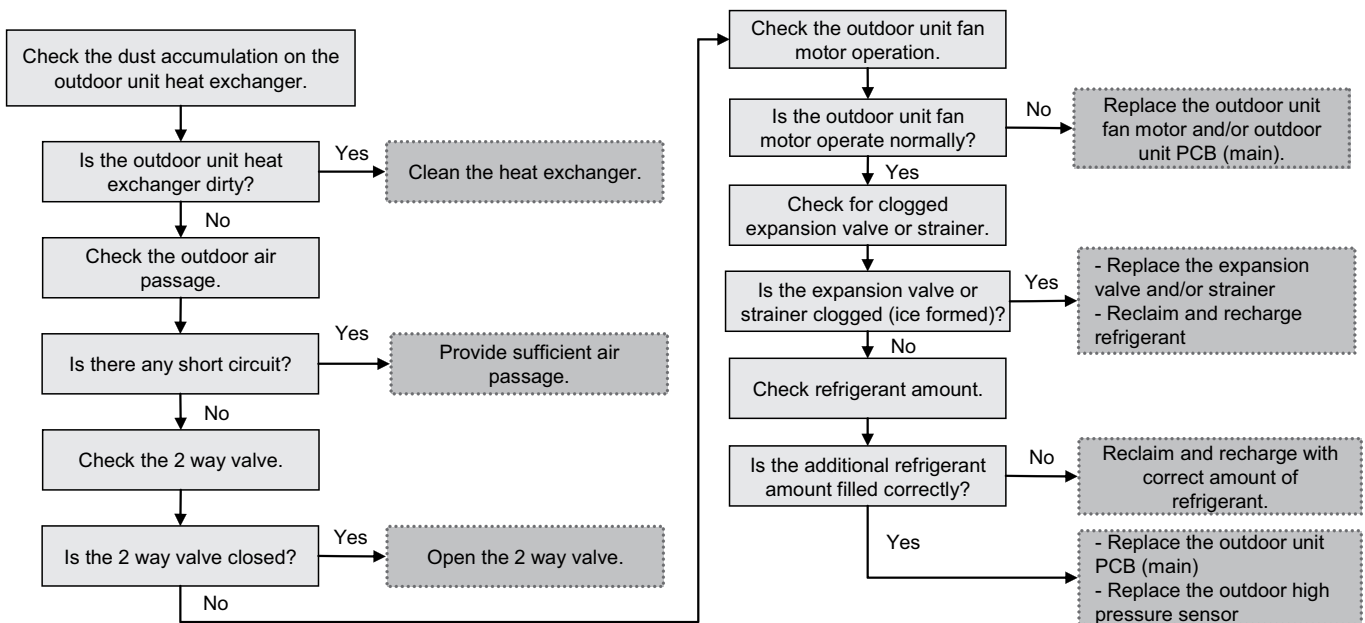

# 17. Disassembly and Assembly Instructions

**⚠ WARNING**

High Voltage are generated in the electrical parts area by the capacitor. Ensure that the capacitor has discharged sufficiently before proceeding with repair work. Failure to heed this caution may result in electric shocks.

## 17.1 To Remove Front Plate

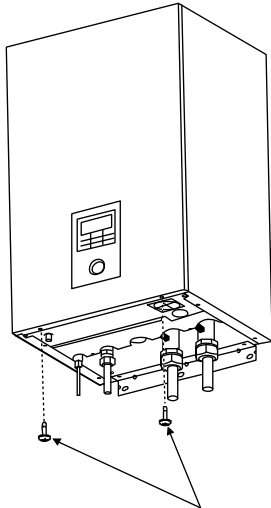

1. Remove the 2 mounting screws which located at bottom of the front plate.

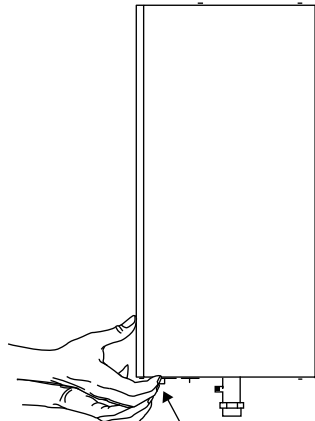

2. Gently pull the lower section of the front plate towards you to remove the front plate from left and right hooks.

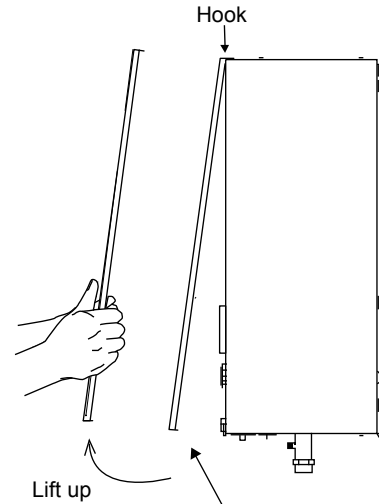

3. Hold the left edge and right edge of front plate to lift up front plate from hooks.

## 17.2 To Remove Pressure Gauge

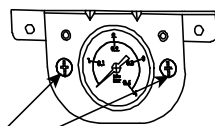

1. Remove 2 screws.

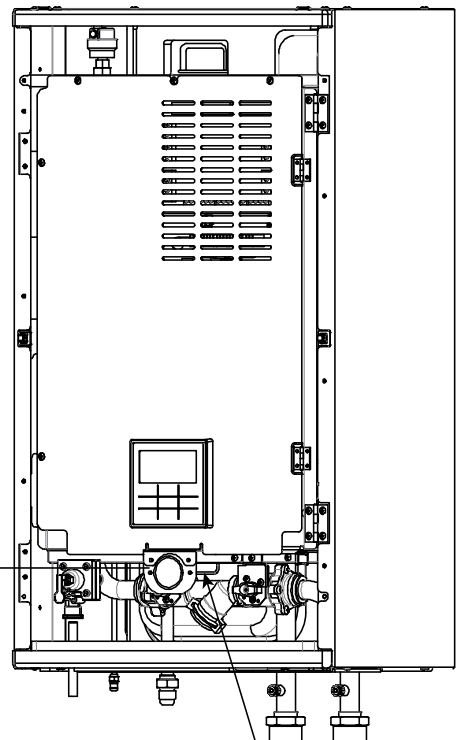

2. Use spanner to release nut of pressure gauge

### 17.3 To Open Control Board Cover

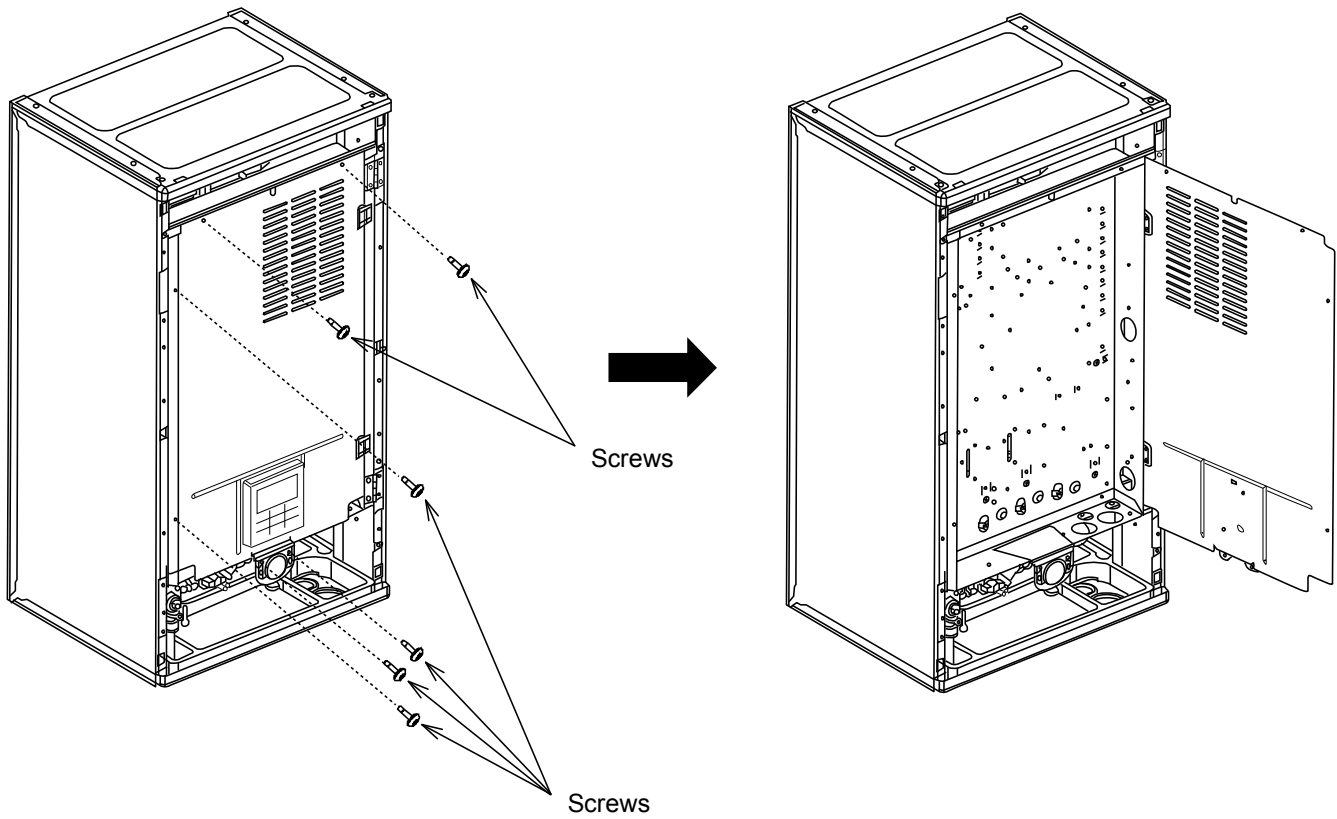

1. Remove 6 screws from the Control Board Cover.

### 17.4 To Remove Control Panel

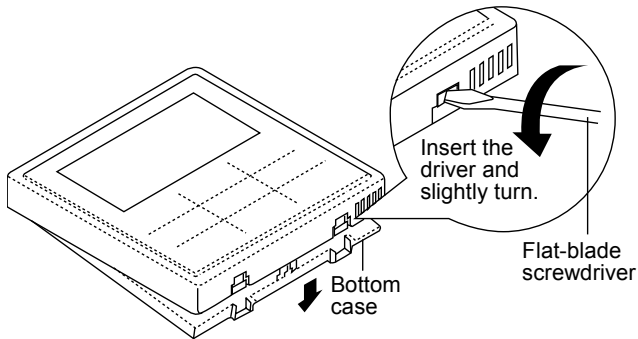

1. Remove the top case from the bottom case.

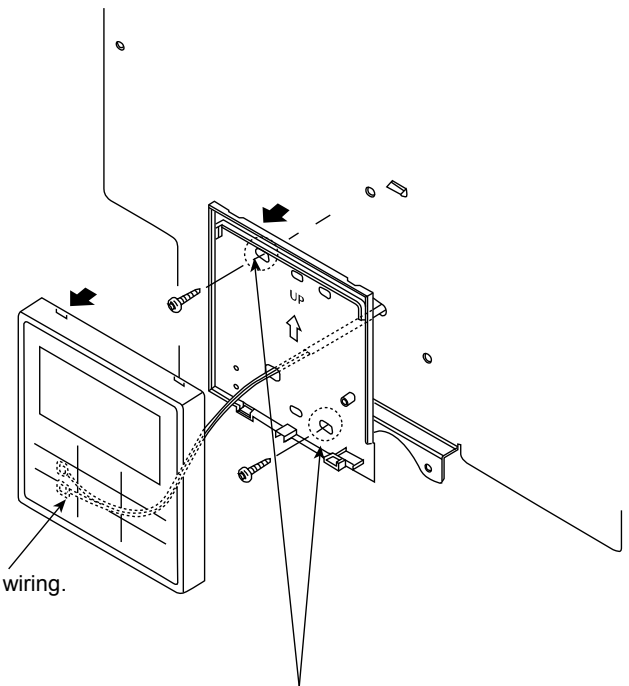

2. Disconnect the Remote Controller wiring.

3. Remove 2 screws then take out the bottom case.



## 17.5 To Remove RCCB

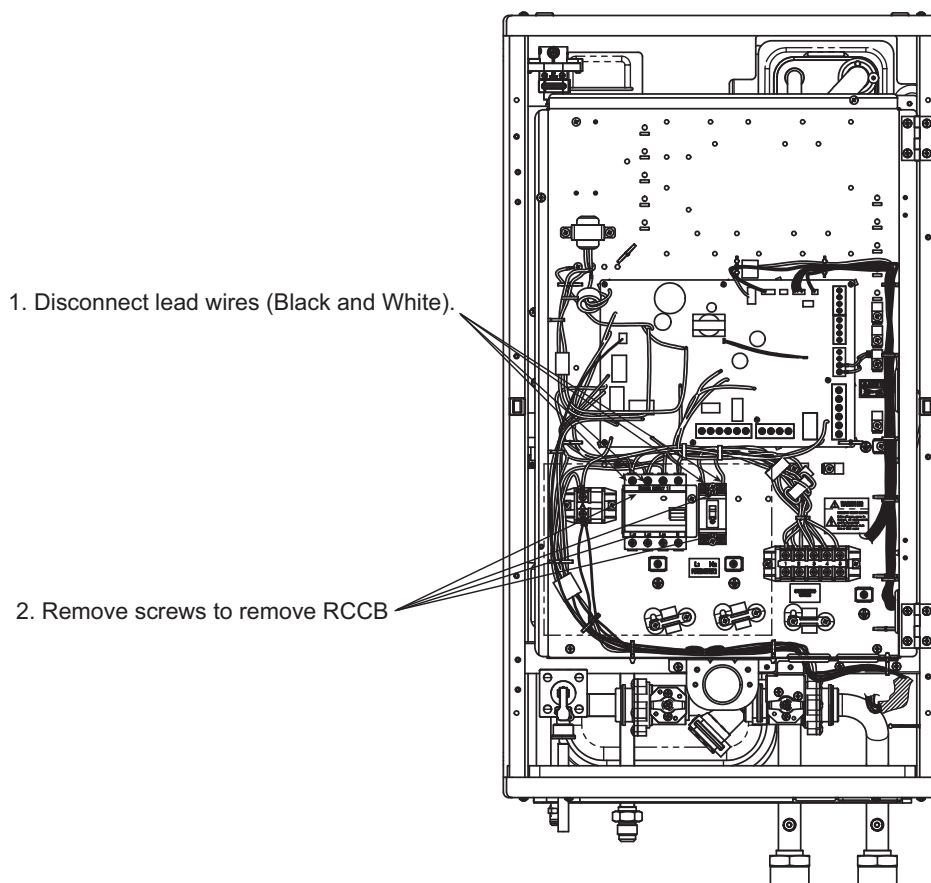

## 17.6 To Remove Transformer and Electronic Controller Board

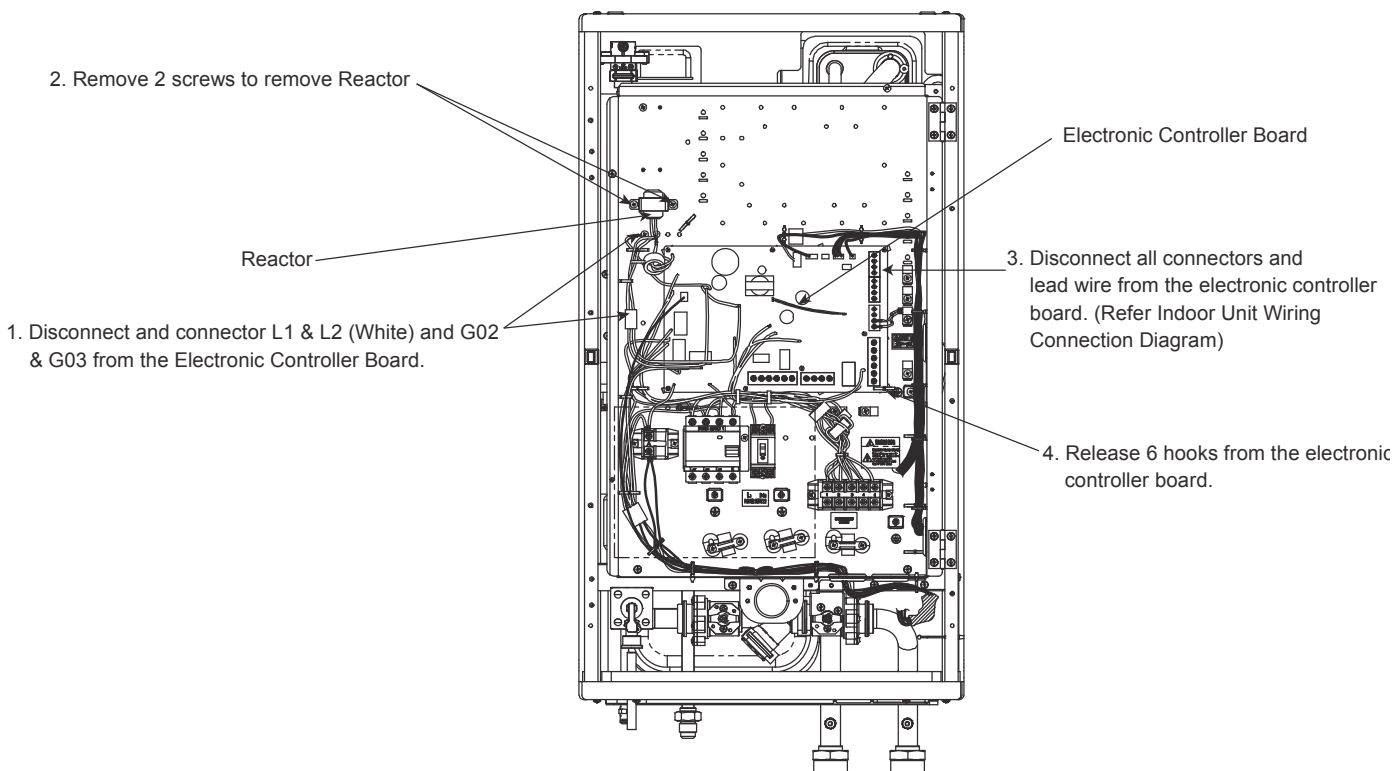

## 17.7 To Open Control Board

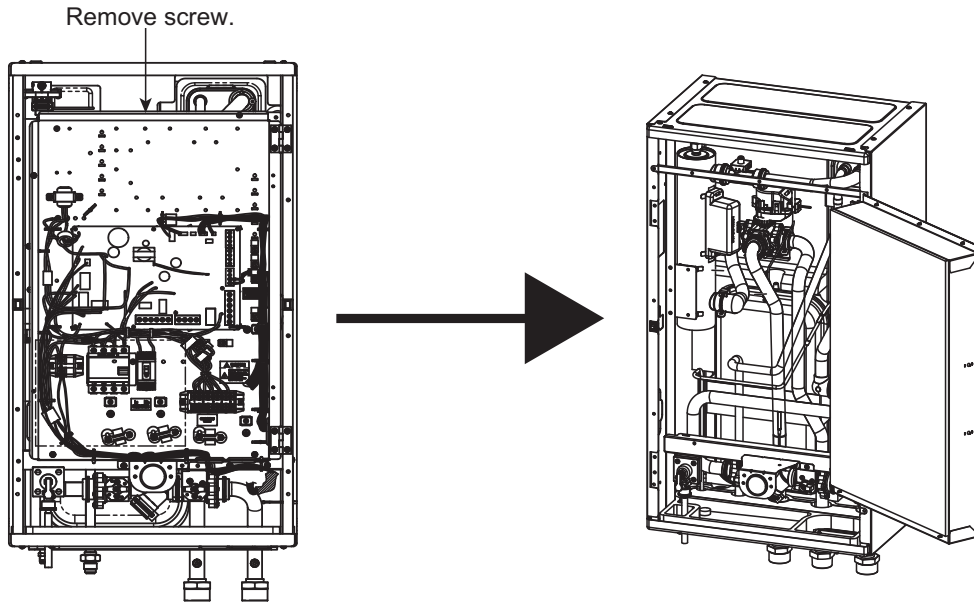

## 17.8 To Remove Pressure Relief Valve, Air Purge Valve and Flow Sensor

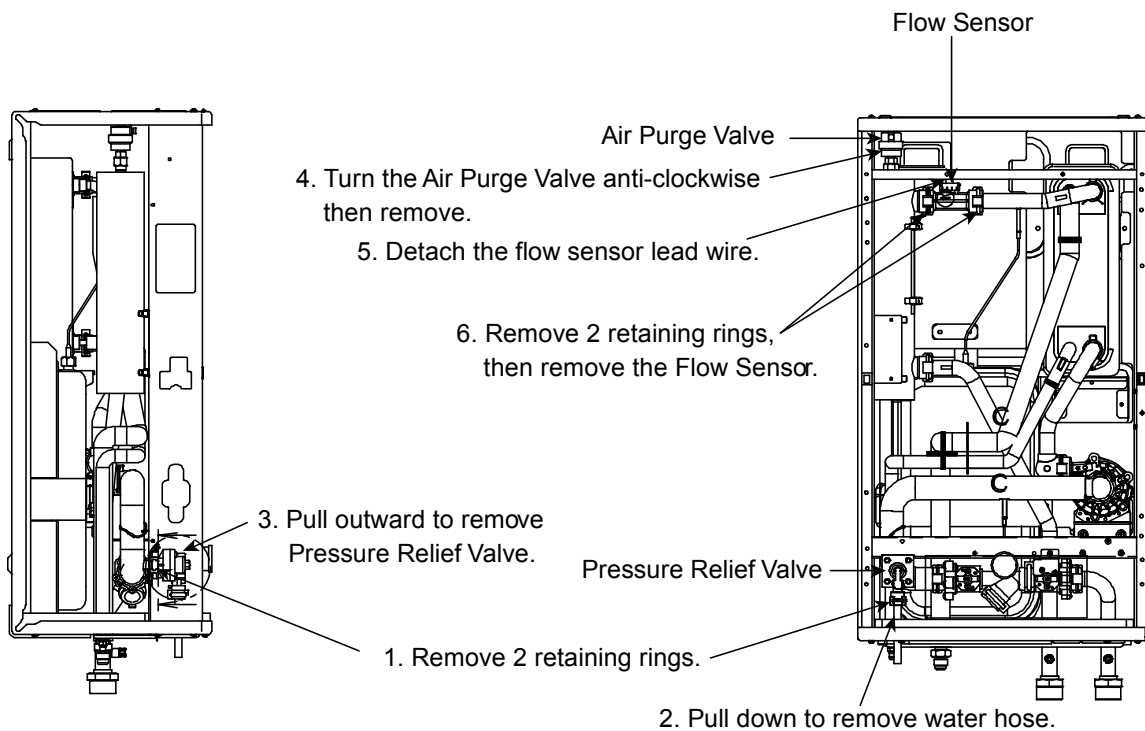

During reinstall Air Purge Valve

Make sure plug is fully close in clockwise direction.

Apply some water based grease on packing surface before fix with shut off valve.

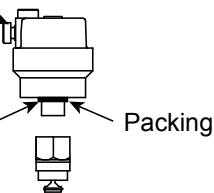

During reinstall Flow Sensor

Make sure the flow sensor is not slanting

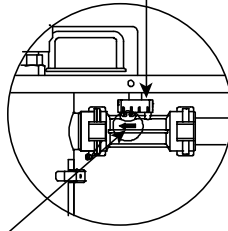

Make sure arrow point to left

### 17.9 To Remove Water Pump and Bottle Complete

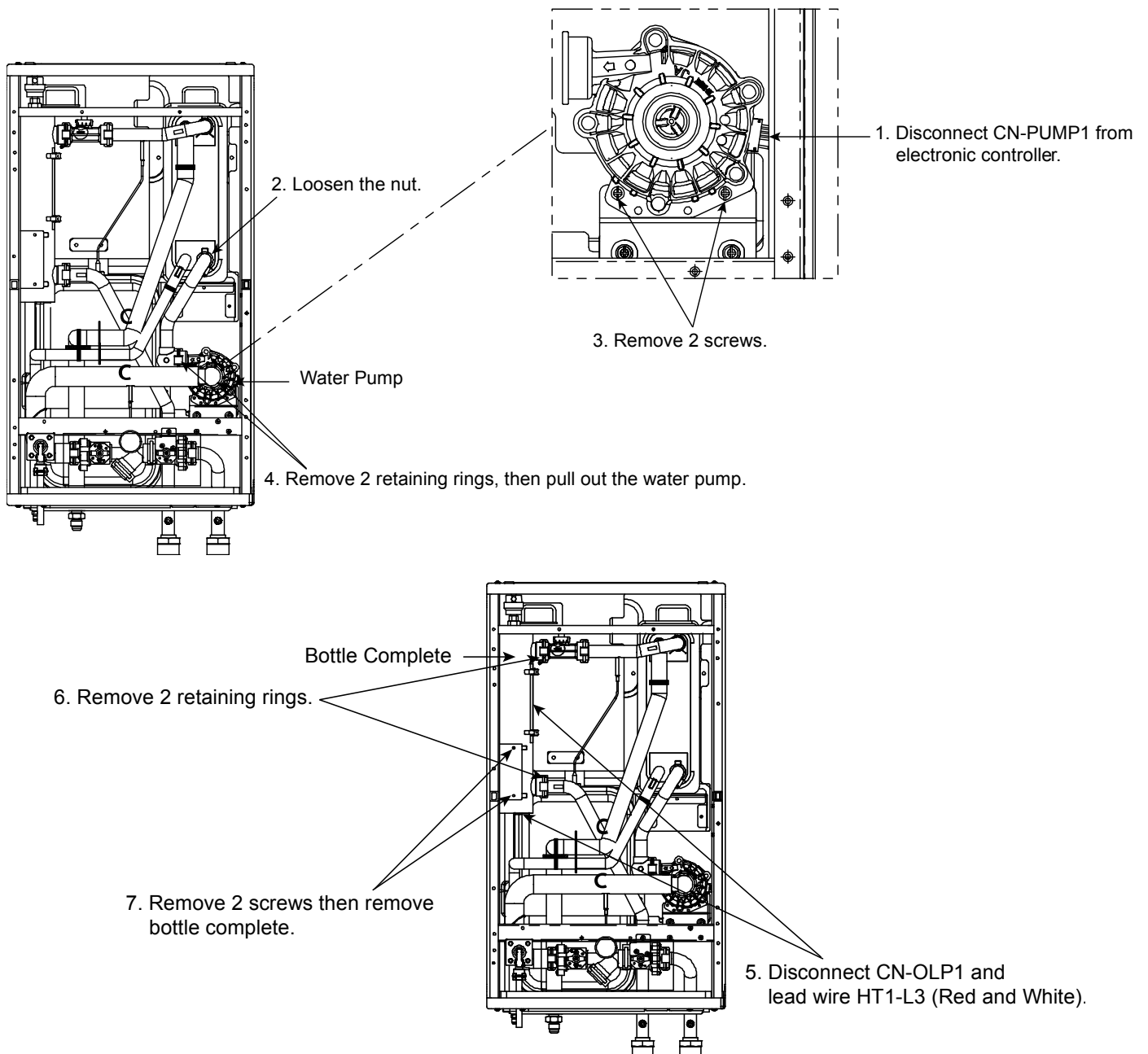

## 17.10 To Remove Filter

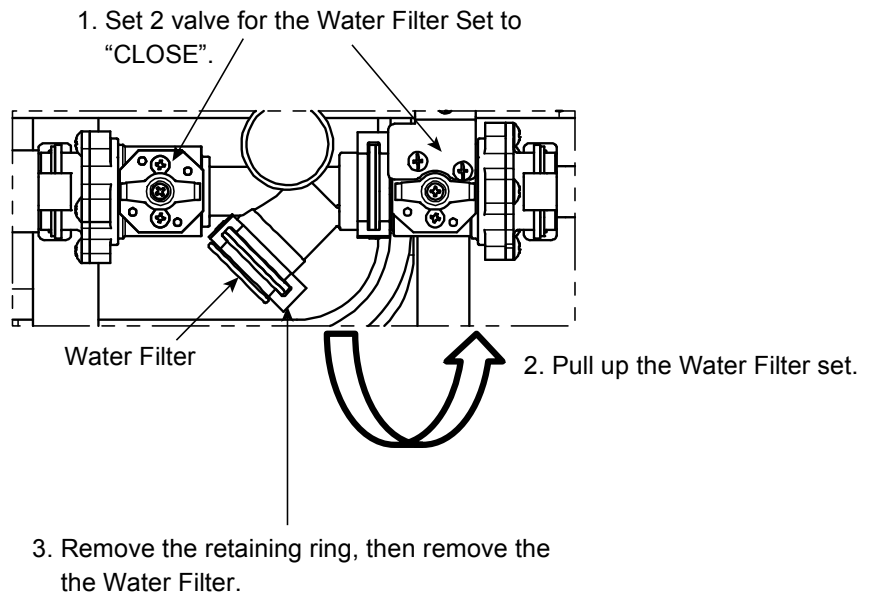
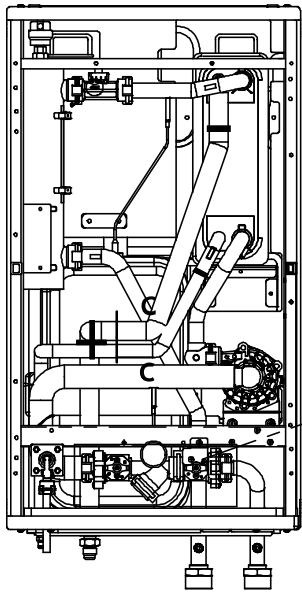

## 18. Technical Data

### 18.1 Operation Characteristics

#### 18.1.1 WH-SXC09H3E5 WH-UX09HE5

##### Heating Characteristics at Different Outdoor Air Temperature

Condition

Outdoor air temperature : 7°C (DBT), 6°C (WBT)

Indoor water inlet temperature : 30°C

Indoor water outlet temperature : 35°C

Piping length : 7 m

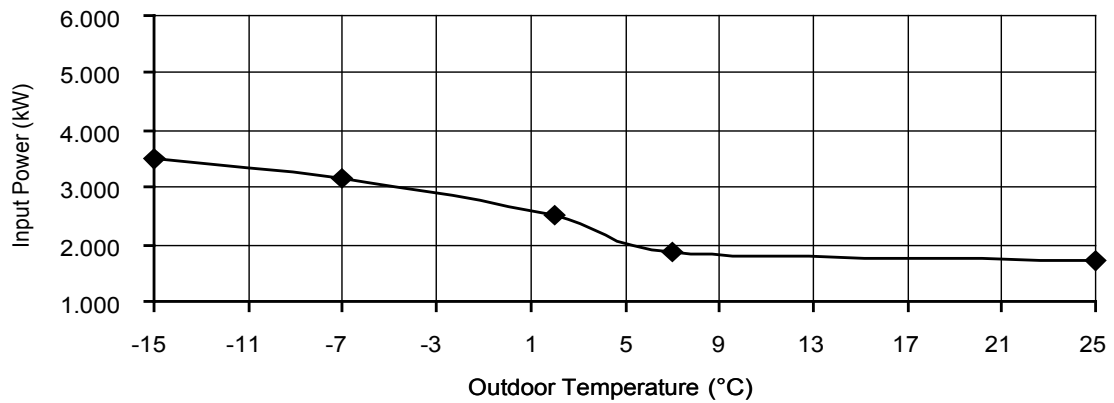
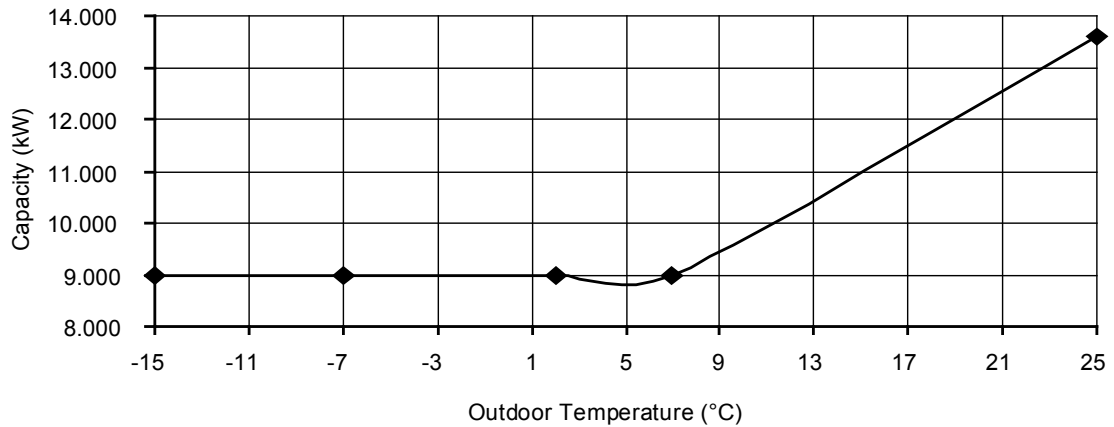

### Cooling Characteristics at Different Outdoor Air Temperature

Condition

Outdoor air temperature : 35°C (DBT), -°C (WBT)

Indoor water inlet temperature : 12°C

Indoor water outlet temperature : 7°C

Piping length : 7 m

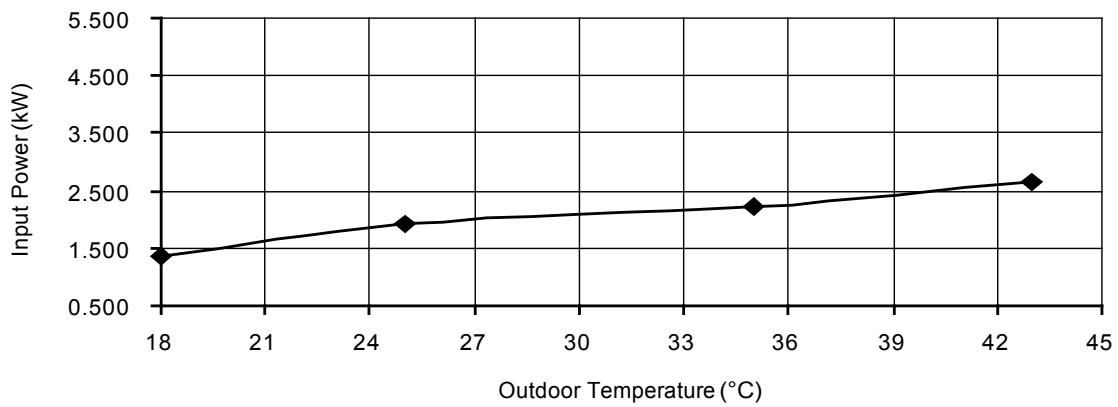
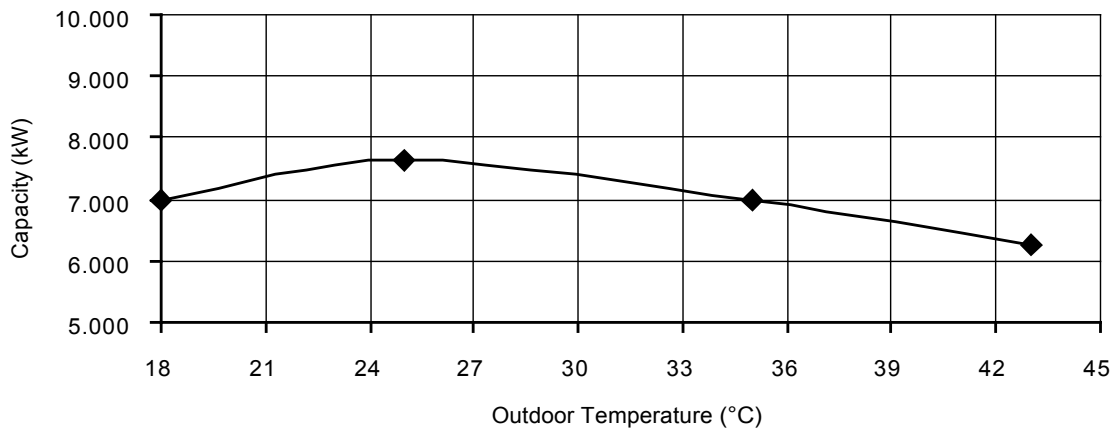

### Cooling Characteristics at Different Outdoor Air Temperature

Condition

Outdoor air temperature : 35°C (DBT), -°C (WBT)

Indoor water inlet temperature : 19°C

Indoor water outlet temperature : 14°C

Piping length : 7 m

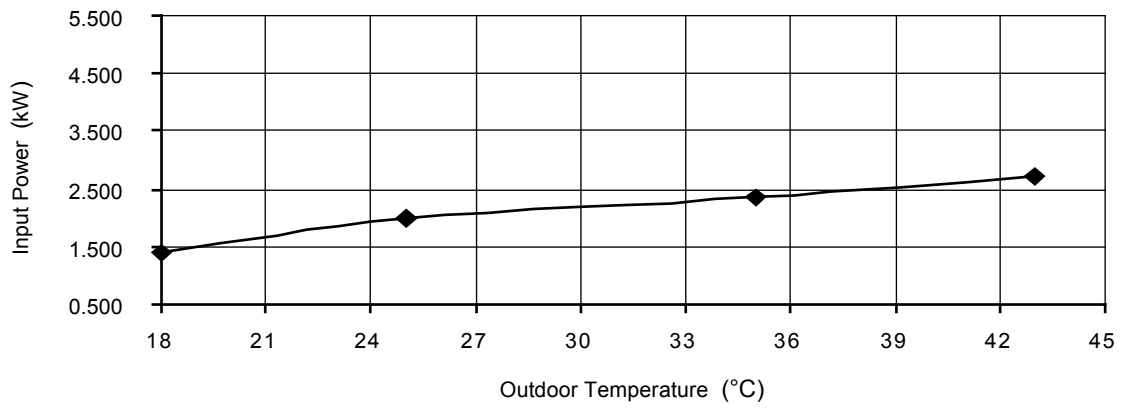
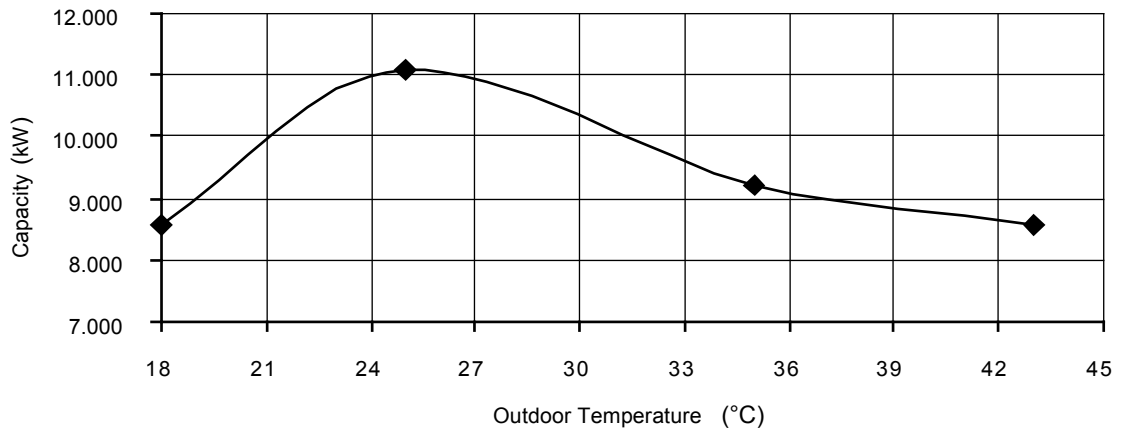

### Cooling Characteristics at Different Outdoor Air Temperature

Condition

Outdoor air temperature : 35°C (DBT), -°C (WBT)

Indoor water inlet temperature : 23°C

Indoor water outlet temperature : 18°C

Piping length : 7 m

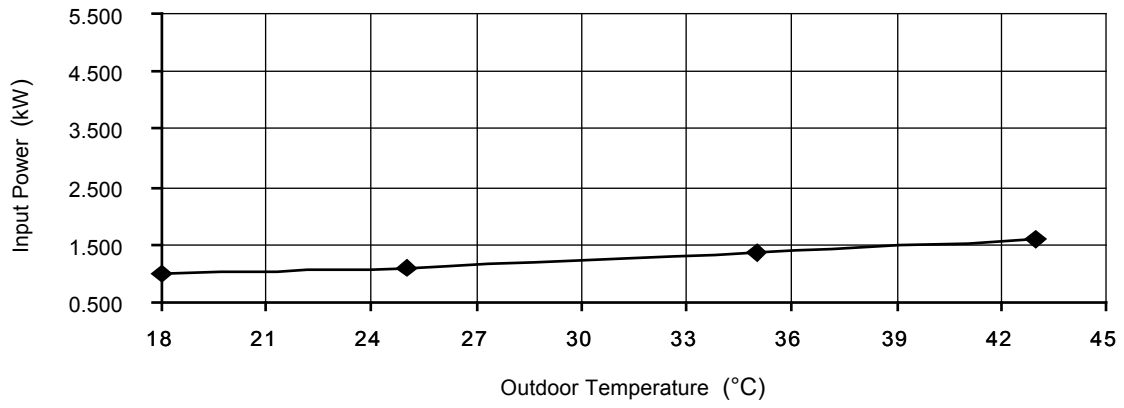
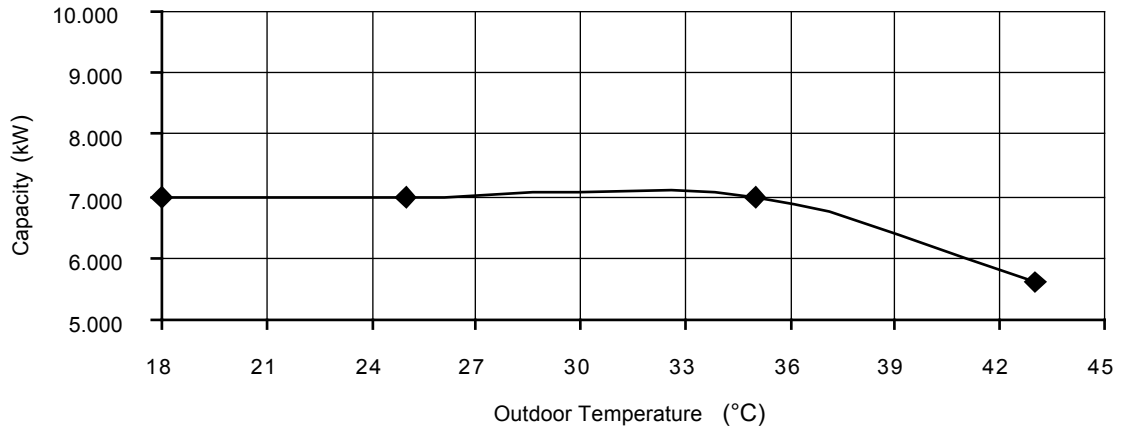



### Heating Characteristics at Different Piping Length

Condition

Outdoor air temperature : 7°C (DBT), 6°C (WBT)

Indoor water inlet temperature : 30°C

Indoor water outlet temperature : 35°C

Piping length : 7 m

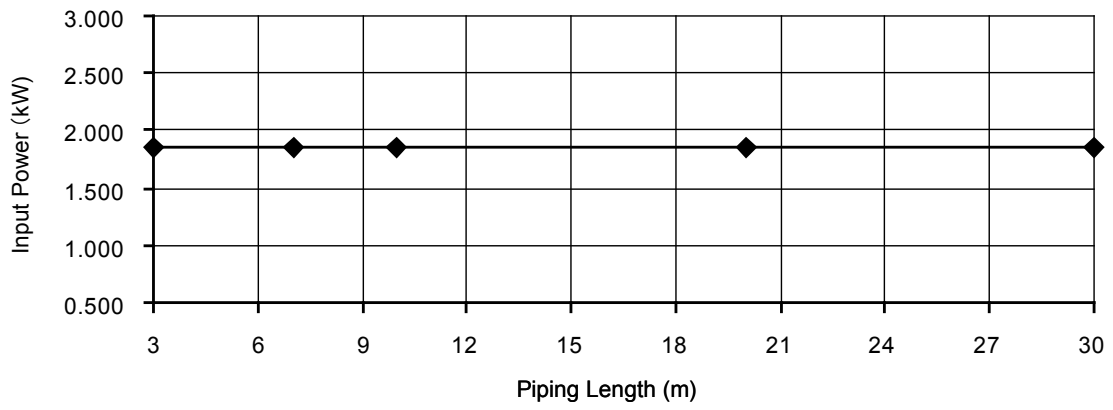
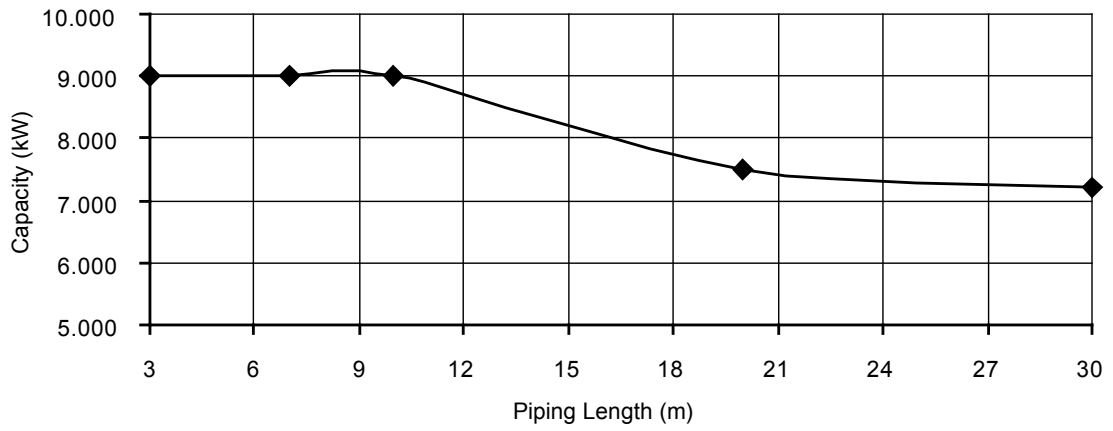

### Cooling Characteristics at Different Piping Length

Condition

Outdoor air temperature : 35°C (DBT), -°C (WBT)

Indoor water inlet temperature : 12°C

Indoor water outlet temperature : 7°C

Piping length : 7 m

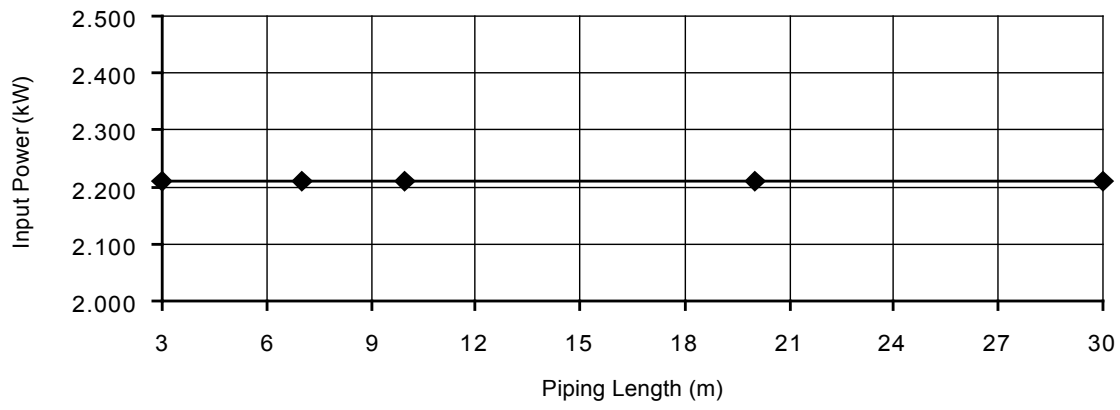
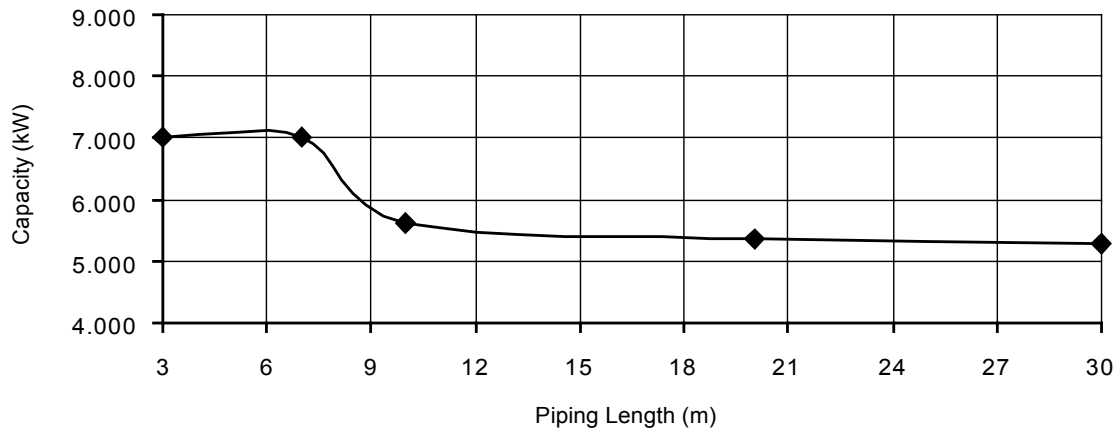

## 18.1.2 WH-SXC12H6E5 WH-UX12HE5

### Heating Characteristics at Different Outdoor Air Temperature

Condition

Outdoor air temperature : 7°C (DBT), 6°C (WBT)

Indoor water inlet temperature : 30°C

Indoor water outlet temperature : 35°C

Piping length : 7 m

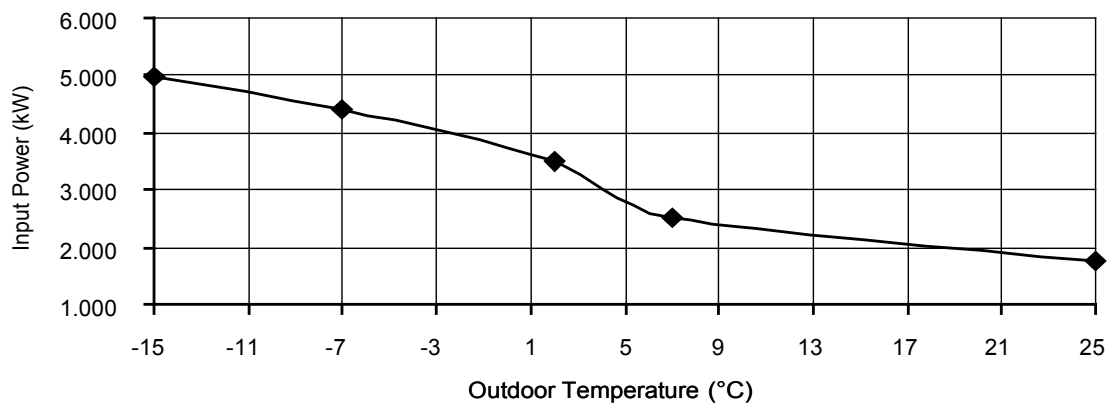
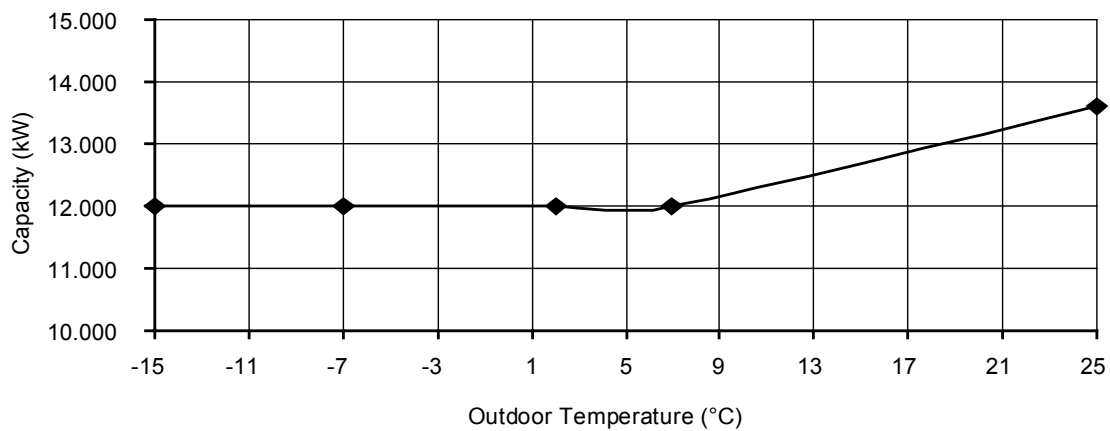

### Cooling Characteristics at Different Outdoor Air Temperature

Condition

Outdoor air temperature : 35°C (DBT), -°C (WBT)

Indoor water inlet temperature : 12°C

Indoor water outlet temperature : 7°C

Piping length : 7 m

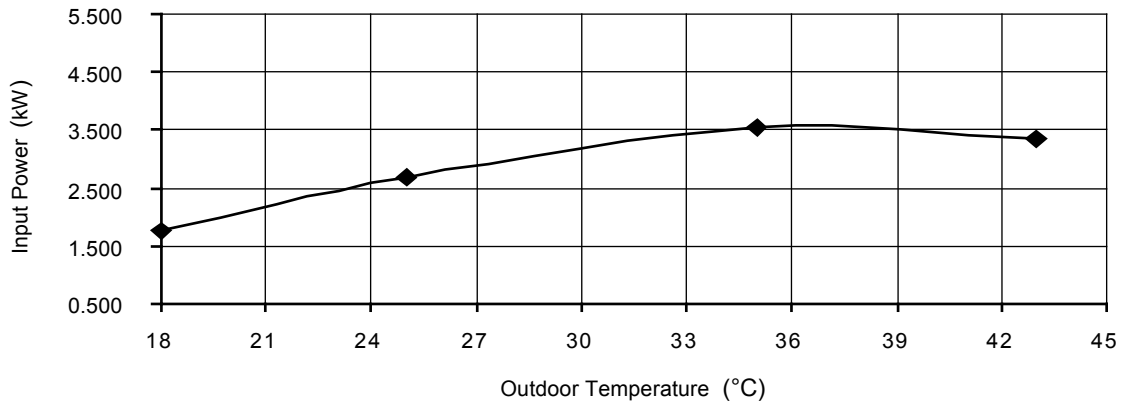
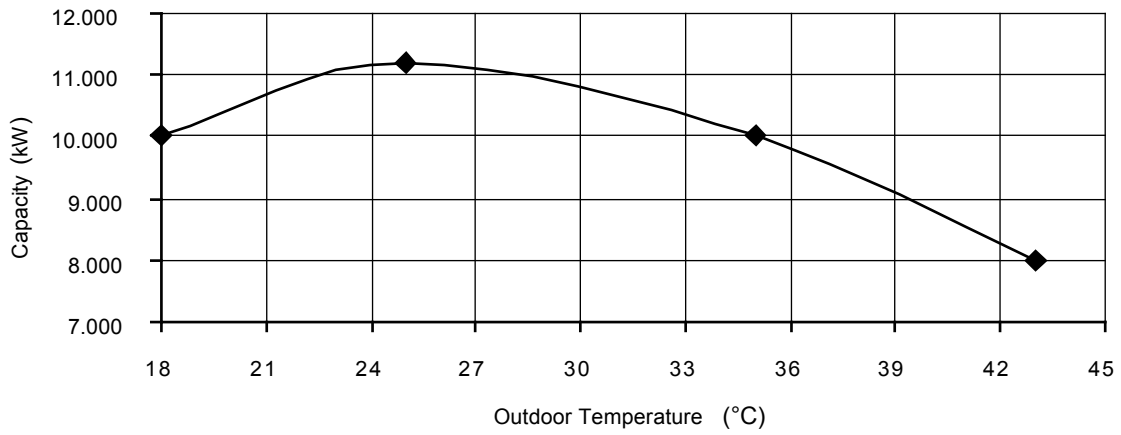

### Cooling Characteristics at Different Outdoor Air Temperature

Condition

Outdoor air temperature : 35°C (DBT), -°C (WBT)

Indoor water inlet temperature : 19°C

Indoor water outlet temperature : 14°C

Piping length : 7 m

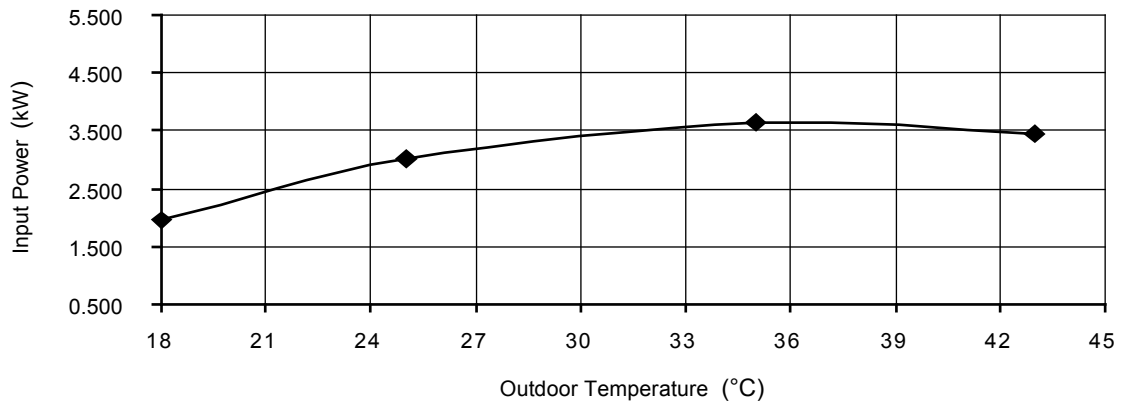
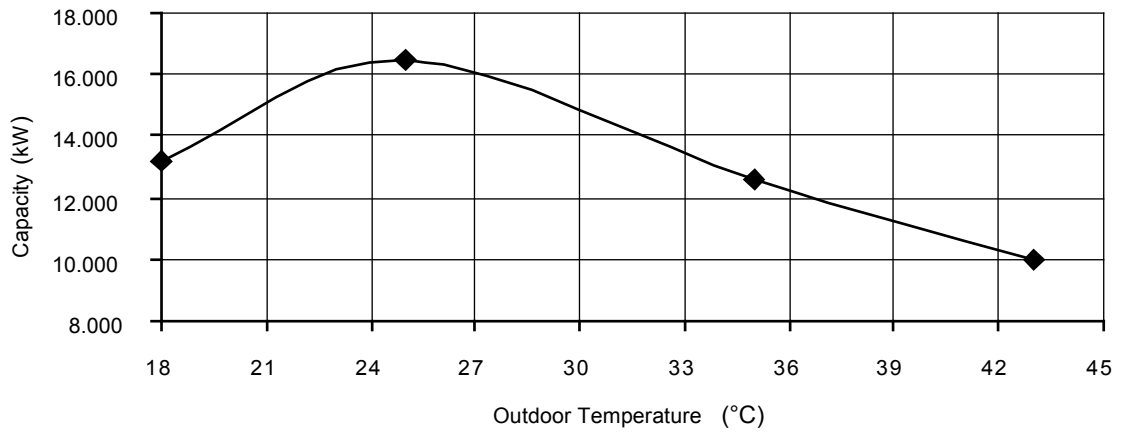

### Cooling Characteristics at Different Outdoor Air Temperature

Condition

Outdoor air temperature : 35°C (DBT), -°C (WBT)

Indoor water inlet temperature : 23°C

Indoor water outlet temperature : 18°C

Piping length : 7 m

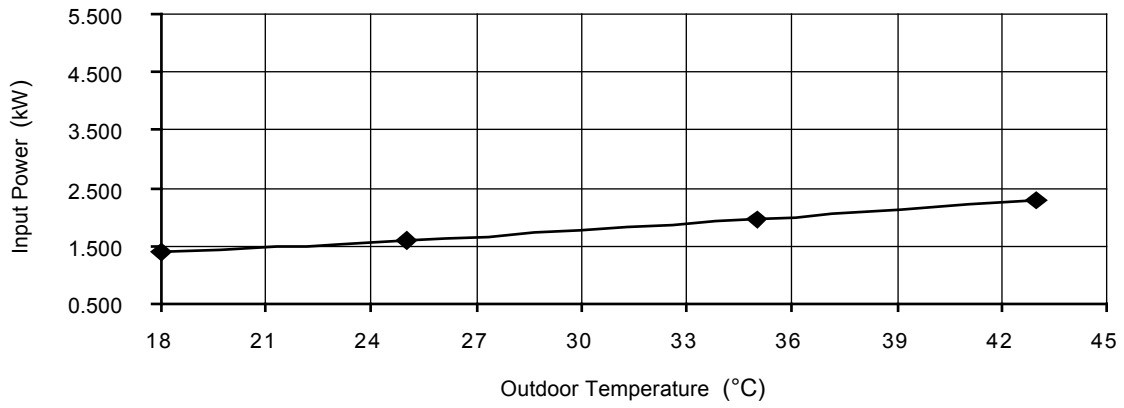
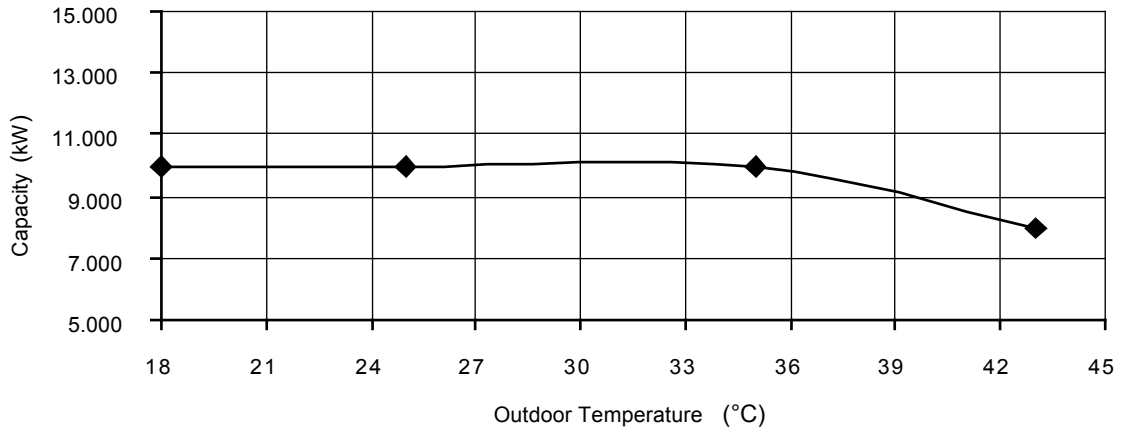

### Heating Characteristics at Different Piping Length

Condition

Outdoor air temperature : 7°C (DBT), 6°C (WBT)

Indoor water inlet temperature : 30°C

Indoor water outlet temperature : 35°C

Piping length : 7 m

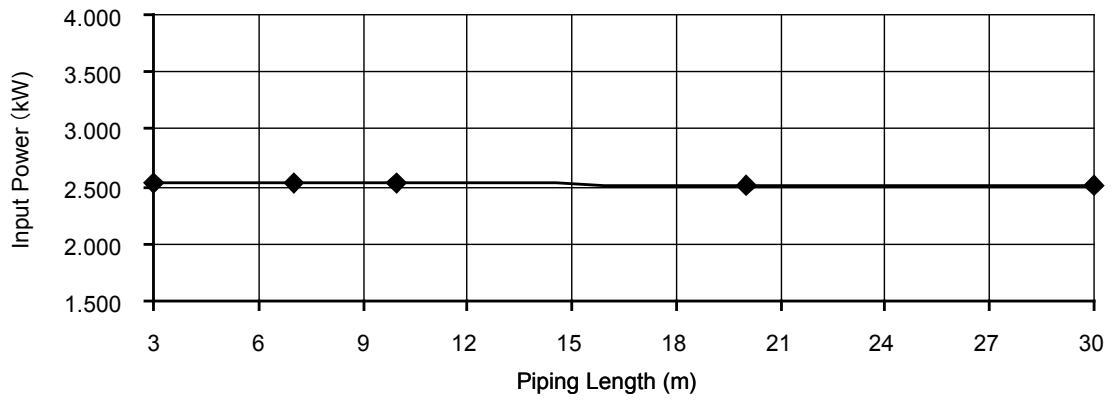
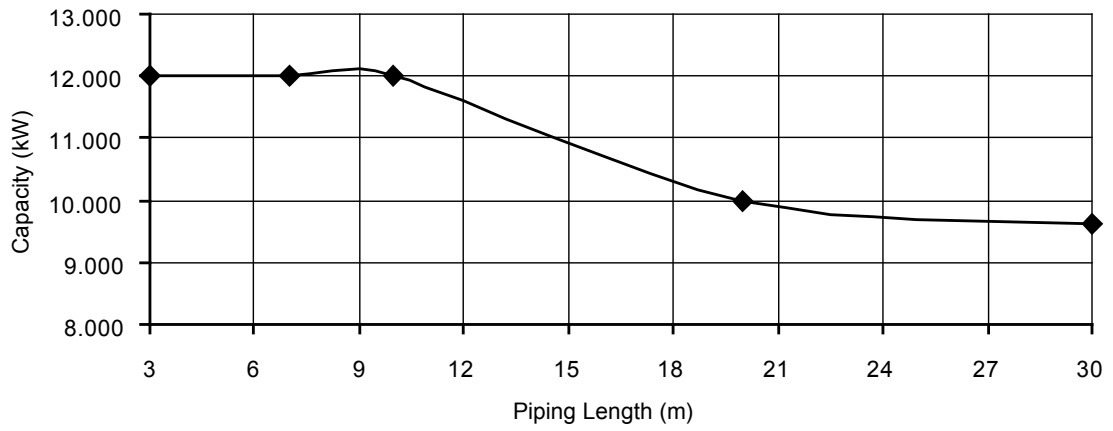

### Cooling Characteristics at Different Piping Length

Condition

Outdoor air temperature : 35°C (DBT), -°C (WBT)

Indoor water inlet temperature : 12°C

Indoor water outlet temperature : 7°C

Piping length : 7 m

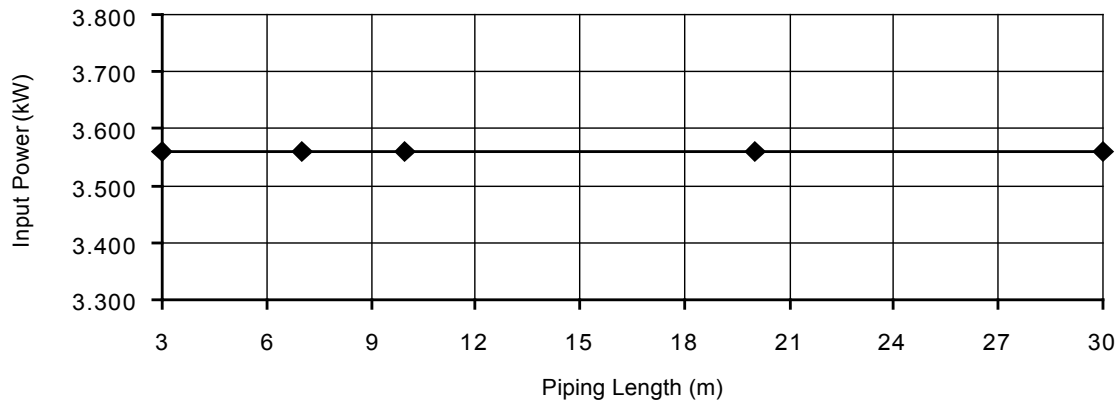
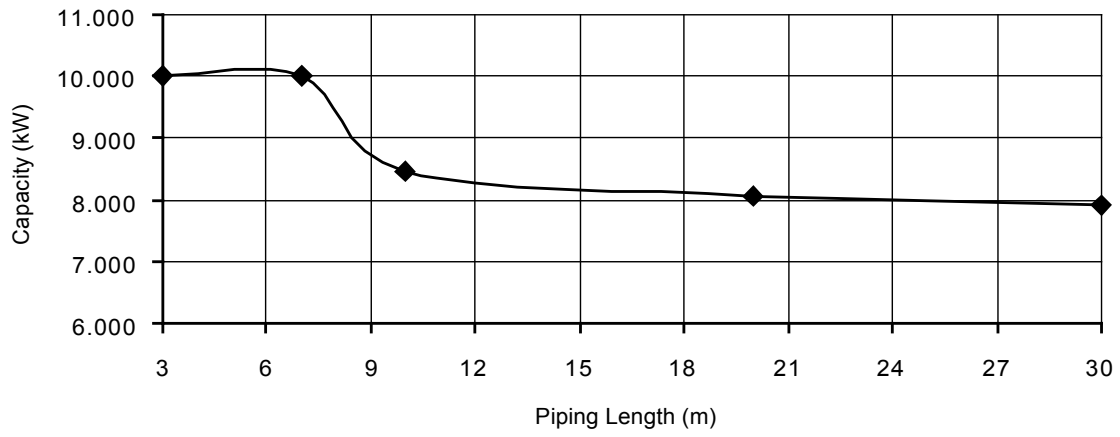



## 18.2 Heating Capacity Table

### 18.2.1 WH-UX09HE5

Water Out (°C)	30		35		40		45		50		55	
Outdoor Air (°C)	Capacity (W)	Input Power (W)	Capacity (W)	Input Power (W)	Capacity (W)	Input Power (W)	Capacity (W)	Input Power (W)	Capacity (W)	Input Power (W)	Capacity (W)	Input Power (W)
-15	9000	3240	9000	3510	9000	3910	9000	4300	9000	4730	9000	5160
-7	9000	2710	9000	3160	9000	3620	9000	4070	9000	4270	9000	4460
2	9000	2360	9000	2510	9000	2780	9000	3050	9000	3560	9000	4070
7	9000	1640	9000	1860	9000	2160	9000	2460	9000	2760	9000	3060
25	13600	1500	13600	1710	13200	1930	12800	2140	12000	2410	11200	2670

### 18.2.2 WH-UX12HE5

Water Out (°C)	30		35		40		45		50		55	
Outdoor Air (°C)	Capacity (W)	Input Power (W)	Capacity (W)	Input Power (W)	Capacity (W)	Input Power (W)	Capacity (W)	Input Power (W)	Capacity (W)	Input Power (W)	Capacity (W)	Input Power (W)
-15	12000	4750	12000	4960	12000	5410	11000	5380	10800	5820	10500	6260
-7	12000	3850	12000	4410	12000	4980	12000	5540	12000	5900	12000	6260
2	12000	3190	12000	3490	12000	3870	12000	4250	12000	4860	12000	5470
7	12000	2180	12000	2530	12000	2960	12000	3390	12000	3780	12000	4160
25	13600	1550	13600	1760	13400	2100	13200	2430	12600	2660	12000	2890

## 18.3 Cooling Capacity Table

### 18.3.1 WH-SXC09H3E5 WH-UX09HE5

Water In (°C)	12		19		23	
Water Out (°C)	7		14		18	
Outdoor Air (°C)	Capacity (W)	Input Power (W)	Capacity (W)	Input Power (W)	Capacity (W)	Input Power (W)
18	7000	1360	8550	1410	7000	1000
25	7650	1910	11100	1980	7000	1100
35	7000	2210	9230	2370	7000	1350
43	6250	2660	8550	2710	5600	1600

### 18.3.2 WH-SXC12H6E5 WH-UX12HE5

Water In (°C)	12		19		23	
Water Out (°C)	7		14		18	
Outdoor Air (°C)	Capacity (W)	Input Power (W)	Capacity (W)	Input Power (W)	Capacity (W)	Input Power (W)
18	10000	1750	13200	1960	10000	1400
25	11200	2670	16500	3010	10000	1600
35	10000	3560	12550	3630	10000	1950
43	8000	3350	10000	3460	8000	2300

# 19. Exploded View and Replacement Parts List

## 19.1 Indoor Unit

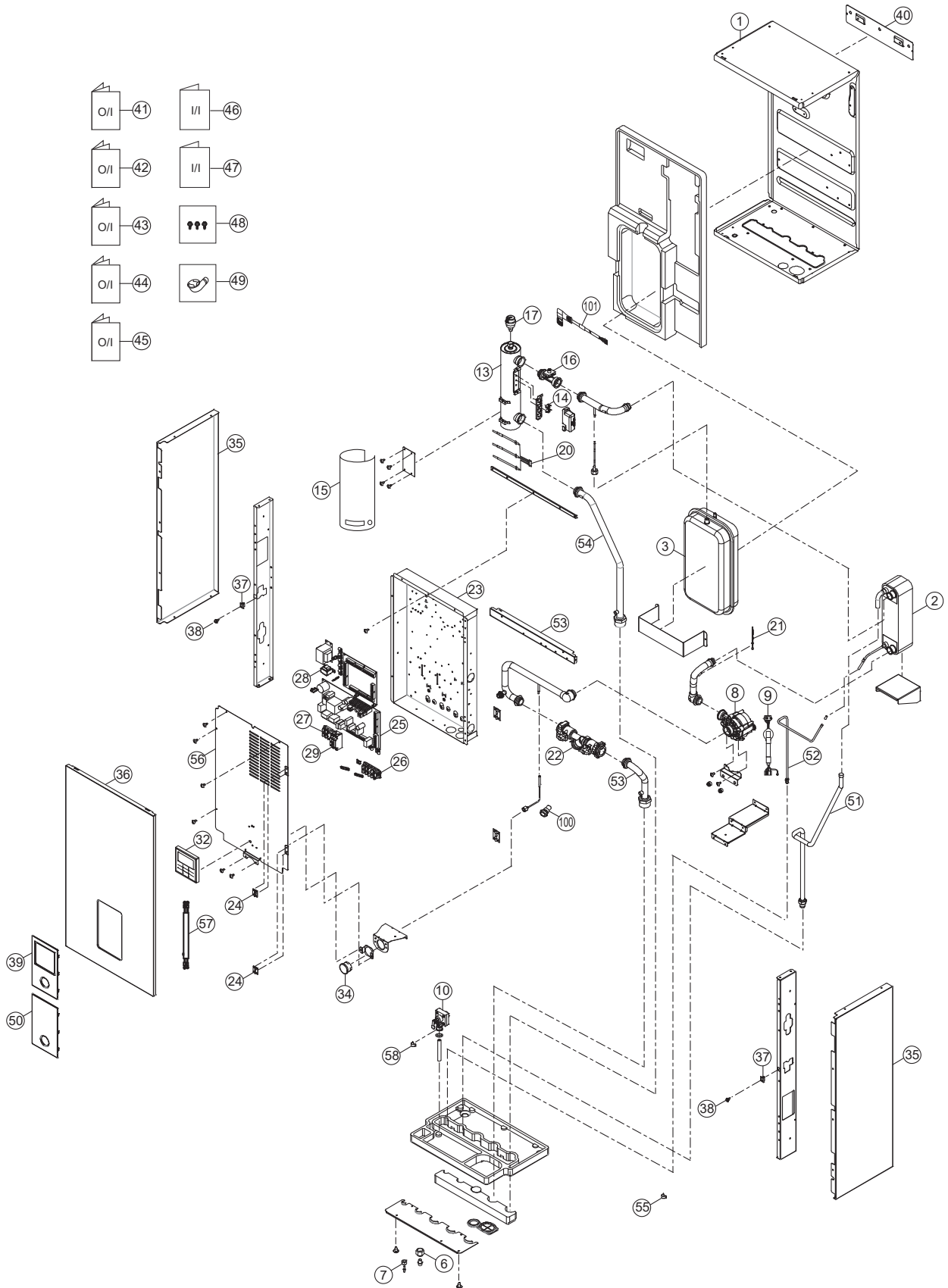

**Note:**

- The above exploded view is for the purpose of parts disassembly and replacement.
- The non-numbered parts are not kept as standard service parts.

<Model: WH-SXC09H3E5 WH-SXC12H6E5>

SAFETY	REF. NO.	DESCRIPTION & NAME	QTY.	WH-SXC09H3E5	WH-SXC12H6E5	REMARK
	1	BASE PAN	1	CWD521450	←	
	2	HOT WATER COIL-COMplete	1	ACXB90C00220	←	
	3	RECEIVER	1	CWB141073	←	
	6	FLARE NUT (7/8)	1	CWT251064	←	
	7	FLARE NUT (5/8)	1	CWT251063	←	
	8	WATER PUMP	1	CWB532116	←	
	9	LEADWIRE (WATER PUMP TO PCB)	1	ACXA60C03450	←	
	10	PRESSURE RELIEF VALVE	1	CWB621136	←	O
	13	HEATER ASS'Y	1	ACXA34K00070	ACXA34K00100	
	14	THERMOSTAT	2/3	CWA151074	←	O
	15	SOUND PROOF MATERIAL	1	ACXG30-00680	←	
	16	FLOW SENSOR	1	CWB621137	←	O
	17	AIR PURGE VALVE	1	ACXB62-00130	←	O
	20	SENSOR-COMP.(WATER IN, OUT & REF TEMP CN-TH1)	1	CWA50C3377	←	O
	21	SENSOR-COMP.(HEX WATER OUTLET TEMP CN-TH3)	1	CWA50C3378	←	O
	22	FILTER COMPLETE	1	CWB51C1021	←	
	23	CONTROL BOARD	1	CWH102629	←	
	24	HINGE	2	CWH611007	←	
⚠	25	ELECTRONIC CONTROLLER-MAIN	1	ACXA73C11910	ACXA73C11920	O
⚠	26	TERMINAL BOARD ASS'Y (1,2,3)	1	CWA28K1217	←	O
⚠	27	TERMINAL BOARD ASS'Y (A,B)	1	CWA28K1238	←	O
⚠	28	REACTOR	1	G0C103Z00003	←	O
	29	RESIDUAL CURRENT CIRCUIT BREAKER	2	K5KYAY00003	←	O
	32	REMOTE CONTROL COMPLETE	1	CWA75C4682	←	O
	34	PRESSURE GAUGE	1	CWB070003	←	O
	35	CABINET SIDE PLATE	2	CWE041850A	←	
	36	CABINET FRONT PLATE	1	CWE061396A	←	
	37	CATCHER	2	CWH601011	←	
	38	LOCK	2	CWH891004	←	
	39	DECORATION BASE ASS'Y	1	CWE35K1285	←	
	40	INSTALLING HOLDER	1	CWH361103A	←	
	41	OPERATING INSTRUCTION	1	ACXF55-04870	←	
	42	OPERATING INSTRUCTION	1	ACXF55-04880	←	
	43	OPERATING INSTRUCTION	1	ACXF55-04890	←	
	44	OPERATING INSTRUCTION	1	ACXF55-04900	←	
	45	OPERATING INSTRUCTION	1	ACXF55-04910	←	
	46	INSTALLATION INSTRUCTION	1	ACXF60-05520	←	
	47	INSTALLATION INSTRUCTION	1	ACXF60-03260	←	
	48	ACCESSORY-COMplete (SCREW)	1	CWH82C1754	←	
	49	ACCESSORY-COMplete (L-TUBE)	1	CWG87C900	←	
	50	ACCESSORY-CO.(DECORATION BASE)	1	CWH82C2174	←	
	51	TUBE CONNECTOR-COMplete (1)	1	ACXT00C03860	←	
	52	TUBE CONNECTOR-COMplete (2)	1	ACXT00C03870	←	

SAFETY	REF. NO.	DESCRIPTION & NAME	QTY.	WH-SXC09H3E5	WH-SXC12H6E5	REMARK
	53	TUBE CONNECTOR-COMplete (3)	1	CWT01C7166	←	
	54	TUBE CONNECTOR-COMplete (4)	1	CWT01C7168	←	
	55	RETAINING RING D:22mm	1	CWH581007	←	
	56	CONTROL BOARD COVER	1	CWH131692	←	
	57	LEADWIRE REMOTE CONTROL 700mm	1	CWA68C2284	←	
	58	PACKING	2	CWB811195	←	
	100	FILTER COMPLETE	1	ACXB51-00080	←	
	101	LEAD WIRE CN - FLWSEN	1	CWA68C2281	←	

**Note:**

- All parts are supplied from PAPAMY, Malaysia (Vendor Code: 00029488).
- "O" marked parts are recommended to be kept in stock.



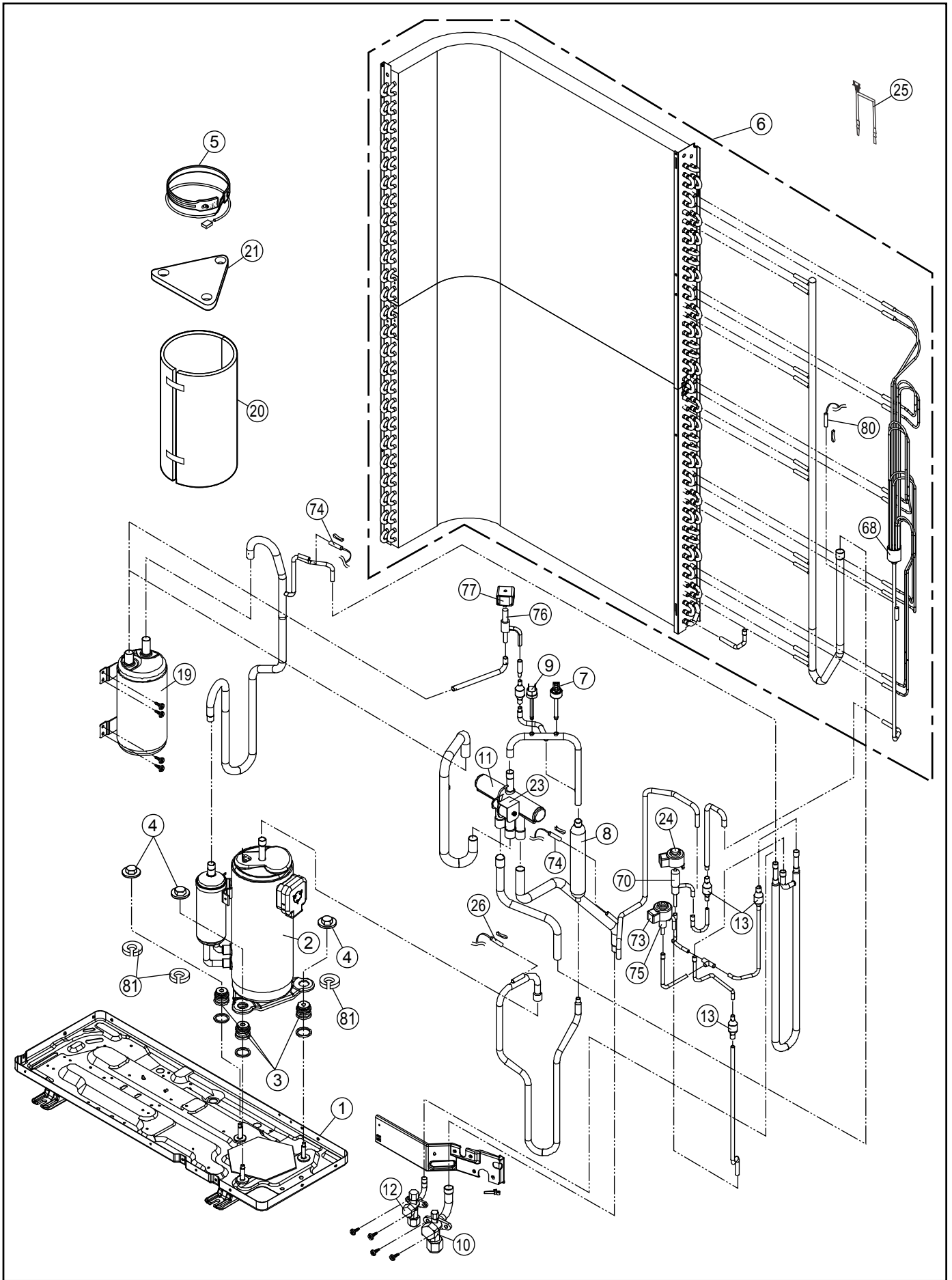

**Note:**

- The above exploded view is for the purpose of parts disassembly and replacement.
- The non-numbered parts are not kept as standard service parts.

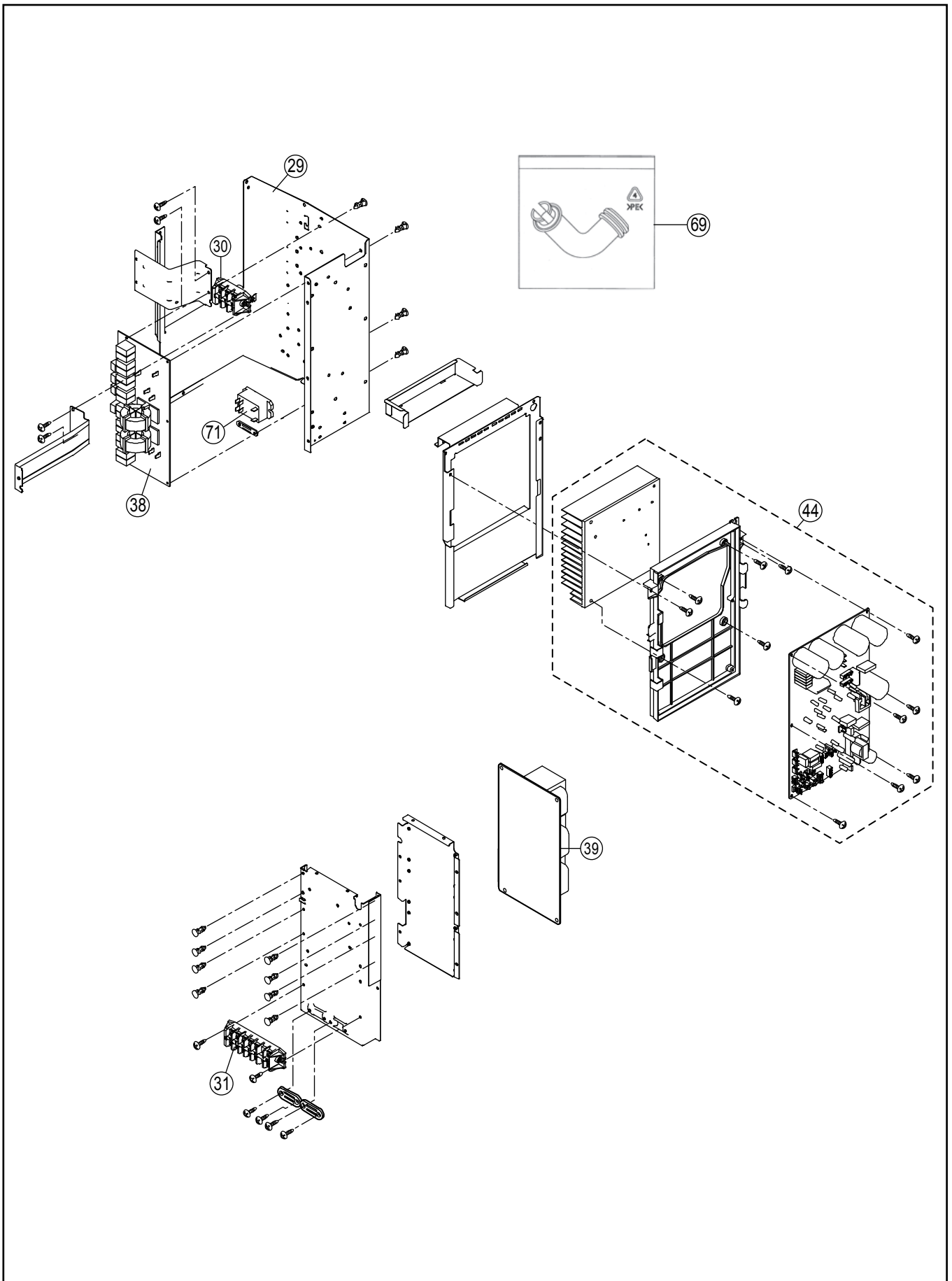



**Note:**

- The above exploded view is for the purpose of parts disassembly and replacement.
- The non-numbered parts are not kept as standard service parts.

<Model: WH-UX09HE5 WH-UX12HE5>

SAFETY	REF. NO.	DESCRIPTION & NAME	QTY.	WH-UX09HE5	WH-UX12HE5	REMARK
	1	BASE PAN ASS'Y	1	ACXD52K00260	←	
	2	COMPRESSOR	1	5JD420XCA22	←	O
	3	BUSHING - COMPRESSOR MOUNT	3	CWH50055	←	
	4	NUT-COMPRESSOR MOUNT	3	CWH561049	←	
	5	CRANKCASE HEATER	1	ACXA34-00110	←	
	6	CONDENSER COMPLETE	1	CWB32C3986	←	
	7	HIGH PRESSURE SENSOR	1	CWA501463	←	O
	8	DISCHARGE MUFFLER	1	CWB121014	←	
	9	PRESSURE SWITCH	1	CWA101007	←	O
	10	3-WAYS VALVE (GAS)	1	CWB011251	←	
	11	4-WAYS VALVE	1	CWB001046	←	
	12	3-WAYS VALVE	1	ACXB01-00040	←	O
	13	STRAINER	3	CWB111032	←	
	19	ACCUMULATOR	1	CWB131026A	←	
	20	SOUND PROOF MATERIAL	1	CWG302795	←	
	21	SOUND PROOF MATERIAL	1	CWG302266	←	
	22	SOUND PROOF BOARD	1	CWH15K1019	←	
	23	V-COIL COMPLETE(4 WAY VALVE)	1	CWA43C2169J	←	O
	24	V-COIL COMPLETE(MAIN EXPANSION VALVE)	1	CWA43C2602	←	O
	25	SENSOR-COMP.(OUTDOOR AIR TEMP SENSOR)	1	CWA50C2730	←	O
	26	SENSOR-COMP.(DISCHARGE TEMP SENSOR)	1	CWA50C2576	←	O
	28	CABINET REAR PLATE-COMPLETE	1	ACXE02C00060	←	
	29	CONTROL BOARD CASING	1	CWH10K1049	←	
	30	TERMINAL BOARD ASS'Y	1	CWA28K1260	←	O
	31	TERMINAL BOARD ASS'Y	1	CWA28K1213	←	O
	38	ELECTRONIC CONTROLLER-NF	1	CWA747852	←	O
	39	ELECTRONIC CONTROLLER (CAPACITOR)	1	CWA747853	←	O
	44	ELECTRONIC CONTROLLER (MAIN)	1	ACXA73C11930R	ACXA73C11940R	O
	46	REACTOR	1	G0C592J00006	←	
	50	FAN MOTOR BRACKET	1	CWD54K1084	←	
	51	SCREW-FAN MOTOR BRACKET	8	CWH551040J	←	
	52	SCREW-FAN MOTOR MOUNT	8	CWH551323	←	
	53	FAN MOTOR (UPPER)	1	EHDS83CAC	←	O
	54	FAN MOTOR (LOWER)	1	EHDS83DAC	←	O
	55	PROPELLER FAN ASSY	2	CWH00K1006	←	
	56	NUT	2	CWH561092	←	
	57	CABINET FRONT PLATE	1	CWE061098A	←	
	58	DISCHARGE GRILLE	2	CWE201073	←	
	59	CABINET SIDE PLATE ASSY	1	CWE04K1023A	←	
	61	CABINET TOP PLATE CO.	1	CWE03C1096	←	
	62	HANDLE	2	CWE161008	←	
	64	PIPE COVER (FRONT)	1	CWD601074A	←	



SAFETY	REF. NO.	DESCRIPTION & NAME	QTY.	WH-UX09HE5	WH-UX12HE5	REMARK
	65	PIPE COVER (BACK)	1	CWD601075A	←	
	66	CABINET FRONT PLATE CO.	1	CWE06C1091	←	
	68	TUBE ASSY (CAP.TUBE)	1	CWT07K1541	←	
	69	ACCESSORY CO.(DRAIN ELBOW)	1	CWG87C900	←	
	70	EXPANSION VALVE (1)	1	CWB051049	←	O
	71	ELECTRO MAGNETIC SWITCH	1	K6C1AYY00003	←	O
	73	V-COIL COMPLETE (BYPASS EXPANSION VALVE)	1	CWA43C2335	←	O
	74	SENSOR-COMP.(BYPASS & EVA EXIT TEMP)	1	CWA50C2807	←	O
	75	EXPANSION VALVE (2)	1	CWB051029	←	O
	76	2-WAYS VALVE	1	CWB021637	←	O
	77	V-COIL COMPLETE (2 WAY VALVE)	1	CWA43C2607	←	O
	80	SENSOR-COMP.(DEFROST TEMP SENSOR)	1	CWA50C2577	←	O
	81	GASKET FOR TERMINAL COVER	3	CWB811017	←	
	82	PANASONIC BADGE	1	CWE373439	←	
	83	INVERTER BADGE	1	CWE373441	←	

**Note:**

- All parts are supplied from PAPAMY, Malaysia (Vendor Code: 00029488).
- "O" marked parts are recommended to be kept in stock.