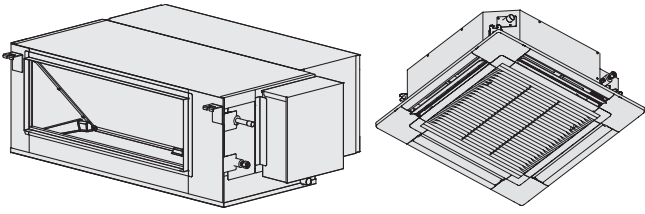
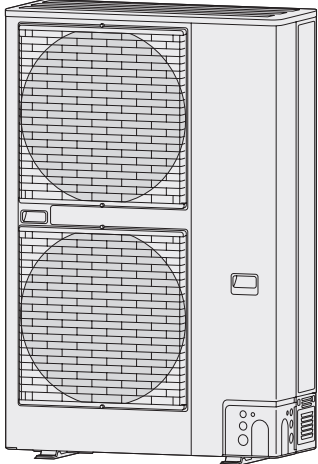


TECHNICAL DATA & SERVICE MANUAL

R32

DC Inverter

Indoor Unit	Outdoor Unit
 <p data-bbox="212 1189 424 1238">High Static Pressure Ducted Type</p> <p data-bbox="536 1189 751 1216">4-Way Cassette Type</p> <p data-bbox="248 1301 657 1429">Type E3 S-200PE3E5B, S-250PE3E5B Type U2 S-50PU2E5B, S-60PU2E5B, S-71PU2E5B S-100PU2E5B, S-125PU2E5B</p>	 <p data-bbox="991 1406 1286 1433">U-200PZH2E8, U-250PZH2E8</p>

IMPORTANT!

Please Read Before Starting

This air conditioner must be installed by the sales dealer or installer.

This information is provided for use only by authorized persons.

For safe installation and trouble-free operation, you must:

- This Installation Instructions is for the indoor unit and read the Installation Instructions of the outdoor unit as well.
- Carefully read this instruction booklet before beginning.
- Follow each installation or repair step exactly as shown.
- This air conditioner shall be installed in accordance with National Wiring Regulations.
- That compliance with national gas regulations shall be observed.
- The product meets the technical requirements of EN/IEC 61000-3-3.
- Pay close attention to all warning and caution notices given in this manual.



WARNING

This symbol refers to a hazard or unsafe practice which can result in severe personal injury or death.



CAUTION

This symbol refers to a hazard or unsafe practice which can result in personal injury or product or property damage.

If Necessary, Get Help

These instructions are all you need for most installation sites and maintenance conditions. If you require help for a special problem, contact our sales/service outlet or your certified dealer for additional instructions.

In Case of Improper Installation

The manufacturer shall in no way be responsible for improper installation or maintenance service, including failure to follow the instructions in this document.



WARNING

- Do not use means to accelerate the defrosting process or to clean, other than those recommended by the manufacturer.
- The appliance shall be stored in a room without continuously operating ignition sources (for example: open flames, an operating gas appliance or an operating electric heater).
- Do not pierce or burn.
- Be aware that refrigerants may not contain an odour.

- The following checks shall be applied to installations using flammable refrigerants.

Appliance shall be installed, operated and stored in a room with a floor area larger than [Amin] m².

As for [Amin], refer to the section "Check of Density Limit" in the Installation Instructions attached to the outdoor unit.

SPECIAL PRECAUTIONS



WARNING When Wiring



ELECTRICAL SHOCK CAN CAUSE SEVERE PERSONAL INJURY OR DEATH. ONLY A QUALIFIED, EXPERIENCED ELECTRICIAN SHOULD ATTEMPT TO WIRE THIS SYSTEM.

- Do not supply power to the unit until all wiring and tubing are completed or reconnected and checked.
- Highly dangerous electrical voltages are used in this system. Carefully refer to the wiring diagram and these instructions when wiring. Improper connections and inadequate grounding can cause **accidental injury or death**.
- Connect all wiring tightly. Loose wiring may cause overheating at connection points and a possible fire hazard.
- Provide a power outlet to be used exclusively for each unit.
- Provide a power outlet exclusively for each unit, and full disconnection means having a contact separation by 3 mm in all poles must be incorporated in the fixed wiring in accordance with the wiring rules.
- To prevent possible hazards from insulation failure, the unit must be grounded.



- Check that cabling will not be subject to wear, corrosion, excessive pressure, vibration, sharp edges or any other adverse environmental effects.
The check shall also take into account the effects of aging or continual vibration from sources such as compressors or fans.
- This equipment is strongly recommended to be installed with Earth Leakage Circuit Breaker (ELCB) or Residual Current Device (RCD). Otherwise, it may cause electrical shock and fire in case of equipment breakdown or insulation breakdown.

When Transporting

- It may need two or more people to carry out the installation work.
- Be careful when picking up and moving the indoor and outdoor units. Get a partner to help, and bend your knees when lifting to reduce strain on your back. Sharp edges or thin aluminum fins on the air conditioner can cut your fingers.

When storing...



WARNING

- The appliance shall be stored in a well-ventilated area where the room size corresponds to the room area as specified for operation.
- The appliance shall be stored in a room without continuously operating open flames (for example: an operating gas appliance) and ignition sources (for example: an operating electric heater).
- The appliance shall be stored so as to prevent mechanical damage from occurring.

When Installing...

- Select an installation location which is rigid and strong enough to support or hold the unit, and select a location for easy maintenance.

- In cases that require mechanical ventilation, ventilation openings shall be kept clear of obstruction.
- An unventilated area where the appliance using flammable refrigerants is installed shall be so constructed that should any refrigerant leak, it will not stagnate so as to create a fire or explosion hazard.

...In a Room

Properly insulate any tubing run inside a room to prevent “sweating” that can cause dripping and water damage to walls and floors.



CAUTION

Keep the fire alarm and the air outlet at least 1.5 m away from the unit.

...In Moist or Uneven Locations

Use a raised concrete pad or concrete blocks to provide a solid, level foundation for the outdoor unit. This prevents water damage and abnormal vibration.

...In an Area with High Winds

Securely anchor the outdoor unit down with bolts and a metal frame. Provide a suitable air baffle.

...In a Snowy Area (for Heat Pump-type Systems)

Install the outdoor unit on a raised platform that is higher than drifting snow. Provide snow vents.

...At least 2.5 m

Indoor unit of this air conditioner shall be installed in a height of at least 2.5 m.

...In laundry rooms

Do not install in laundry rooms. Indoor unit is not drip proof.

When Connecting Refrigerant Tubing

Pay particular attention to refrigerant leakages.



WARNING

- When performing piping work, do not mix air except for specified refrigerant in refrigeration cycle. It causes capacity down, and risk of explosion and injury due to high tension inside the refrigerant cycle.
- If the refrigerant comes in contact with a flame, it produces a toxic gas.
- Do not add or replace refrigerant other than specified type. It may cause product damage, burst and injury, etc.
- Ventilate the room immediately, in the event that is refrigerant gas leaks during the installation. Be careful not to allow contact of the refrigerant gas with a flame as this will cause the generation of toxic gas.
- Keep all tubing runs as short as possible.
- Use the flare method for connecting tubing.
- Apply refrigerant lubricant to the matching surfaces of the flare and union tubes before connecting them, then tighten the nut with a torque wrench for a leak-free connection.
- Check carefully for leaks before starting the test run.
- Do not leak refrigerant while piping work for an installation or re-installation, and while repairing refrigeration parts. Handle liquid refrigerant carefully as it may cause frostbite.
- Under no circumstances shall potential sources of ignition be used in the searching or detection of refrigerant leaks.
- A halide torch (or any other detector using a naked flame) shall not be used.
- Electronic leak detectors may be used to detect refrigerant leaks but, the sensitivity may not be adequate, or may need re-calibration. (Detection equipment shall be calibrated in a refrigerant-free area.)
- Ensure that the detector is not a potential source of ignition and is suitable for the refrigerant used.
- Leak detection equipment shall be set at a percentage of the lower flammable limit (LFL) of the refrigerant and shall be calibrated to the refrigerant employed and the appropriate percentage of gas (25 % maximum) is confirmed.
- Leak detection fluids are suitable for use with most refrigerants but the use of detergents containing chlorine shall be avoided as the chlorine may react with the refrigerant and corrode the copper pipe-work.
- If a leak is suspected, all naked flames shall be removed/extinguished.
- If a leakage of refrigerant is found which requires brazing, all of the refrigerant shall be recovered from the system, or isolated (by means of shut off valves) in a part of the system remote from the leak. Oxygen free nitrogen (OFN) shall then be purged through the system both before and during the brazing process.

When Servicing

- Contact to the sales dealer or service dealer for a repair.
- Be sure to turn off the power before servicing.
- Turn the power OFF at the main power box (mains), wait at least 5 minutes until it is discharged, then open the unit to check or repair electrical parts and wiring.
- Keep your fingers and clothing away from any moving parts.
- Clean up the site after you finish, remembering to check that no metal scraps or bits of wiring have been left inside the unit.





WARNING

- This product must not be modified or disassembled under any circumstances. Modified or disassembled unit may cause fire, electric shock or injury.
- Do not clean inside the indoor and outdoor units by users. Engage authorized dealer or specialist for cleaning.
- In case of malfunction of this appliance, do not repair by yourself. Contact the sales dealer or service dealer for a repair and disposal.



CAUTION

- Ventilate any enclosed areas when installing or testing the refrigeration system. Leaked refrigerant gas, on contact with fire or heat, can produce dangerously toxic gas.
- Confirm after installation that no refrigerant gas is leaking. If the gas comes in contact with a burning stove, gas water heater, electric room heater or other heat source, it can cause the generation of toxic gas.

Others

When disposal of the product, do follow the precautions in "12. Recovery" on page 1-12-1-1-6 and comply with national regulations.



WARNING

- Do not sit or step on the unit. You may fall down accidentally.



CAUTION

- Do not touch the air inlet or the sharp aluminum fins of the outdoor unit. You may get injured.
- Do not stick any object into the FAN CASE. You may be injured and the unit may be damaged.

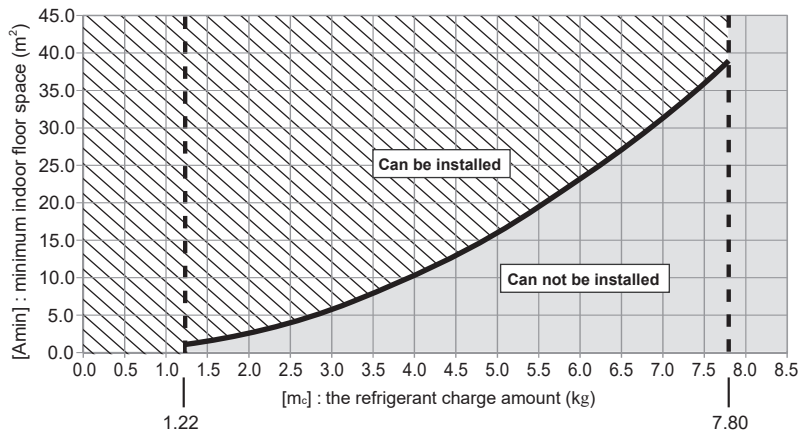


Check of Density Limit

U-200PZH2E8, U-250PZH2E8

The refrigerant (R32), which is used in the air conditioner, is a flammable refrigerant. So the requirements for installation space of appliance are determined according to the refrigerant charge amount [m_c] used in the appliance.

The minimum indoor floor space compared with the amount of refrigerant is roughly as follows:



• 7.80 indicates m_{max} digit of the model U-200PZH2E8, U-250PZH2E8.

[m_c] : The refrigerant charge amount (Total of refrigerant at shipment and refrigerant charge amount in the field).

[m_{max}] : Maximum refrigerant charge amount

	U-200PZH2E8 U-250PZH2E8
m_{max}	7.80 kg

[m_c] \leq 1.22 : Can be installed

1.22 < [m_c] \leq [m_{max}] : Installation possible with in the range of slanted line part


[m_c] > [m_{max}] : Can not be installed

Precautions for Installation Using New Refrigerant

1. Care regarding tubing

(1) Process tubing

- Material: Use seamless phosphorous deoxidized copper tube for refrigeration. Wall thickness shall comply with the applicable legislation. For tubes of $\varnothing 22.22$ or larger, use the material of temper 1/2H or H (Hard copper tube). Do not bend the hard copper tube.
- For the renewal tubing size, refer to the Technical Data.
- Use a tube cutter when cutting the tubing, and be sure to remove any flash. This also applies to distribution joints (optional).
- When bending tubing, use a bending radius that is 4 times the outer diameter of the tubing or larger.

 CAUTION	Use sufficient care in handling the tubing. Seal the tubing ends with caps or tape to prevent dirt, moisture, or other foreign substances from entering. These substances can result in system malfunction.
--	--

- (2) Prevent impurities including water, dust and oxide from entering the tubing. Impurities can cause R32 refrigerant deterioration and compressor defects. Due to the features of the refrigerant and refrigerating machine oil, the prevention of water and other impurities becomes more important than ever.

2. Be sure to recharge the refrigerant only in liquid form.

- (1) Since refrigerant composition changes and performance decreases when gas leaks, collect the remaining refrigerant and recharge the required total amount of new refrigerant after fixing the leak.

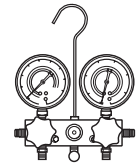
3. Different tools required

- (1) Tool specifications have been changed due to the characteristics of R32.
Some tools for R22- and R407C-type refrigerant systems cannot be used.

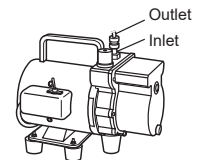
Item	Different tools? (From R22 and R407C)	R410A tools compatible with R32?	Remarks
Manifold gauge	Yes	Yes	Types of refrigerant, refrigerating machine oil, and pressure gauge are different.
Charge hose	Yes	Yes	To resist higher pressure, material must be changed.
Vacuum pump	Yes	Yes	Use a conventional vacuum pump if it is equipped with a check valve. If it has no check valve, purchase and attach a vacuum pump adapter.
Leak detector	Yes	Yes	Leak detectors for CFC and HCFC that react to chlorine do not function because R32 and R410A contains no chlorine. Leak detectors for HFC can be used for R32 and R410A.
Flaring oil	Yes	Yes	For systems that use R22, apply mineral oil (Suniso oil) to the flare nuts on the tubing to prevent refrigerant leakage. For machines that use R32 or R410A, apply synthetic oil (ether oil) to the flare nuts.

* Using tools for R22 and R407C can cause defects.

Manifold gauge



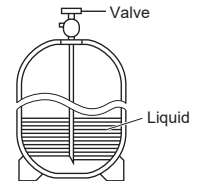
Vacuum pump



Single-outlet valve

(with siphon tube)

Liquid refrigerant should be recharged with the cylinder standing on end as shown.



Important Information Regarding The Refrigerant Used

This product contains fluorinated greenhouse gases. Do not vent gases into the atmosphere.

Refrigerant type: R32


GWP⁽¹⁾ value: 675

⁽¹⁾GWP = global warming potential

Periodical inspections for refrigerant leaks may be required depending on European or local legislation. Please contact your local dealer for more information.

Fill in the blanks below with the indelible ink pens.

- 1 : the factory refrigerant charge of the product
- 2 : the additional refrigerant amount charged in the field
- 1 + 2 : the total refrigerant charge
- $(1 + 2) \times 3 / 1000$: CO₂ equivalent in tons; multiply the total refrigerant charge by GWP value, then divided by 1000.

 **This product contains fluorinated greenhouse gases.**
CO₂ equivalent amount is shown in "CO₂ eq." 4

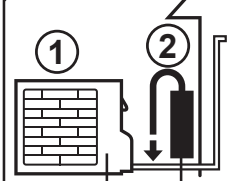
R32

① = kg 1

② = kg 2

① + ② = kg 3

"CO₂ eq."
 $\frac{(\textcircled{1} + \textcircled{2}) \times \textcircled{3}}{1\ 000} =$ ton 8



1. Factory refrigerant charge of the product: see unit name plate
2. Additional refrigerant amount charged in the field*
3. Total refrigerant charge
4. Contains fluorinated greenhouse gases
5. Outdoor unit
6. Refrigerant cylinder and manifold for charging
7. GWP(global warming potential) of the refrigerant used in this product
8. CO₂ equivalent of fluorinated greenhouse gases contained in this product

* See the section "5. REFRIGERANT INSTALLATION" on page 1-12-1-1-10 to 1-12-1-1-12.

Combination of Indoor and Outdoor Units

PZH2

3-phase

	200	250
E3	S-200PE3E5B U-200PZH2E8	S-250PE3E5B U-250PZH2E8

	50	60	71	100	125
U2				S-100PU2E5B x2 U-200PZH2E8	S-125PU2E5B x2 U-250PZH2E8
			S-71PU2E5B x3 U-200PZH2E8		
	S-50PU2E5B x4 U-200PZH2E8	S-60PU2E5B x4 U-250PZH2E8			

— CONTENTS —

Section 1. SPECIFICATIONS	1-1-1-1-1
1-1. Unit Specifications	1-1-1-1-2
1-2. Major Component Specifications	1-1-1-2-1
1-3. Other Component Specifications	1-1-1-3-1
1-4. Dimensional Data	1-4-1
1-5. Refrigerant Flow Diagram	1-5-1
1-6. Operating Range	1-6-1
1-7. Capacity Correction Graph According to Temperature Condition	1-7-1
1-8. Noise Criterion Curves	1-8-1
1-9. Airflow Distance Chart	1-9-1
1-10. Fresh Air Intake	1-10-1
1-11. ELECTRICAL WIRING	1-11-1
1-12. Installation Instructions	1-12-1-1-1
1-13. Capacity Table	1-13-1
1-14. Information Table	1-14-1
Section 2. TEST RUN	2-1
2-1. Preparing for Test Run	2-2
2-2. Precautions	2-3
2-3. Caution	2-4
2-4. Test Run Procedure	2-4
2-5. Items to Check Before the Test Run	2-5
2-6. Test Run Using the Remote Controller	2-5
2-7. Contents of Remote Controller Switch Alarm Display	2-6
2-8. System Control	2-8
2-9. Test Run Procedure	2-14
2-10. CHECKS AFTER INSTALLATION HAVE COMPLETED	2-14
2-11. REGARDING DELIVERY TO THE CUSTOMER	2-14
2-12. Caution for Pump Down	2-15
Section 3. ELECTRICAL DATA	3-1
3-1. Outdoor Units (Electric Wiring Diagram)	3-2
3-2. Indoor Units (Electric Wiring Diagram)	3-3
Section 4. PROCESS AND FUNCTIONS.....	4-1
4-1. Control Functions	4-2
4-2. Outdoor Unit Control PCB (ACXA73-3030*, ACXA73-3028*).....	4-9
4-3. Outdoor Unit HIC Board (ACXA73-3104*).....	4-15
4-4. Indoor Unit Control PCB Switches and Functions.....	4-16
Section 5. TROUBLE DIAGNOSIS.....	5-1
5-1. Contents of Remote Controller Switch Alarm Display	5-2
5-2. Outdoor Unit Control Panel LED Display	5-4
5-3. PAC System Alarm Codes	5-5
5-4. Inspection of Parts (Outdoor Unit)	5-32
5-5. Symptom: Thermostat in OFF continues or cycles OFF & ON too frequently.....	5-33
5-6. Table of Thermistor Characteristics	5-34
5-7. How to Remove the Compressor	5-35
5-8. How to Remove the Electrical Component Box	5-36
5-9. Symptom: Thermostat in OFF continues or cycles OFF & ON too frequently.....	5-37
Section 6. OUTDOOR UNIT MAINTENANCE REMOTE CONTROLLER.....	6-1
6-1. Overview	6-2
6-2. Functions	6-2
6-3. Normal Display Operations and Functions	6-3
6-4. Monitoring Operations: Display of Indoor Unit and Outdoor Unit Sensor Temperatures	6-8
6-5. Monitoring the Outdoor Unit Alarm History: Display of Outdoor Unit Alarm History....	6-10
6-6. Settings Modes: Setting the Outdoor Unit EEPROM	6-11

Section 7. REMOTE CONTROLLER FUNCTIONS SECTION.....	7-1
7-1. Simple Settings Function	7-2
7-2. List of Simple Setting Items.....	7-4
7-3. Detailed Settings Function	7-5
7-4. List of Detailed Setting Items	7-7
7-5. Simple Setting Items	7-11
7-6. Detailed Setting Items	7-13
7-7. Remote Controller Servicing Functions	7-17
7-8. Test Run Function	7-19
Section 8. HOW TO INSTALL THE WIRELESS REMOTE CONTROLLER RECEIVER.....	8-1
■ Important Safety Instructions	8-2
■ Optional Controller (Remote Controller)	8-3
8-1. Names and Functions	8-3
8-2. Installing Batteries	8-5
8-3. Setting the Current Time	8-5
8-4. Operation	8-6
8-5. Timer Operation	8-7
8-6. Lock Individual Flap	8-8
8-7. Operating Multiple In/Outdoor Units Simultaneously (Group Control)	8-8
8-8. Using the Remote Controller	8-9
8-9. Pairing Addresses	8-9
8-10. Emergency Operation	8-11
8-11. Miscellaneous Settings	8-12
8-12. Button Control	8-12
8-13. nanoe™ X Setting	8-13
8-14. ECONAVI Setting	8-13
8-15. Ventilation Setting	8-13
8-16. Energy Saving Setting	8-13
8-17. Temperature Automatic Return	8-14
8-18. Troubleshooting	8-15
■ Optional Controller (Remote Controller)	8-16
8-19. Names and Functions	8-16
8-20. Installing Batteries	8-18
8-21. Setting the Current Time	8-18
8-22. Operation	8-19
8-23. Timer Operation	8-20
8-24. Adjusting the Wind Direction	8-21
8-25. Operating Multiple In/Outdoor Units Simultaneously (Group Control)	8-21
8-26. Using the Remote Controller	8-22
8-27. For Best Results	8-22
8-28. Addresses	8-22
8-29. Emergency Operation	8-24
8-30. Miscellaneous Settings	8-25
8-31. Before Requesting Service	8-26
■ Wiring for the Receiver	8-27
8-32. Common to All Models	8-27
8-33. CZ-RWSU3, CZ-RWRU3	8-29
8-34. CZ-RWSC3, CZ-RWRC3	8-31
8-35. Common to All Models	8-35

– MEMO –

1. SPECIFICATIONS

1-1.	Unit Specifications.....	1-1-1-1-2
1-2.	Major Component Specifications	1-1-1-2-1
1-3.	Other Component Specifications	1-1-1-3-1
1-4.	Dimensional Data	1-4-1
1-5.	Refrigerant Flow Diagram	1-5-1
1-6.	Operating Range	1-6-1
1-7.	Capacity Correction Graph According to Temperature Condition	1-7-1
1-8.	Noise Criterion Curves	1-8-1
1-9.	Airflow Distance Chart	1-9-1
1-10.	Fresh Air Intake	1-10-1
1-11.	ELECTRICAL WIRING.....	1-11-1
1-12.	Installation Instructions	1-12-1-1-1
	■ Outdoor Unit	
	1. U-200PZH2E8, U-250PZH2E8.....	1-12-1-1-1
	Supplement	1-12-1-2-1
	■ Indoor Unit	
	Type E3	
	1. S-200PE3E5B, S-250PE3E5B.....	1-12-2-1-1
	Type U2	
	2. S-50PU2E5B, S-60PU2E5B, S-71PU2E5B, S-100PU2E5B, S-125PU2E5B	1-12-2-2-1
1-13.	Capacity Table	1-13-1
1-14.	Information Table	1-14-1

Single-Type

1-1. Unit Specifications

PZH2

High Static Pressure Ducted Type S-200PE3E5B / U-200PZH2E8

INDOOR		MODEL	S-200PE3E5B			-			-		
PANEL		MODEL	-			-			-		
OUTDOOR		MODEL	-			U-200PZH2E8			-		
Branch pipe		MODEL	-			-			-		
Performance test condition			ISO13253 / EN14511 / EN12102 / EN14825								
Power supply		Ø, Hz	1Ø 50Hz			3Ø 50Hz			Min	Max	
		V	220V	230V	240V	380V	400V	415V			
C O L U M N I N G	Capacity	kW	19.5	19.5	19.5	-	-	-	5.7	21.0	
		BTU/h	66500	66500	66500	-	-	-	19400	71700	
	Current	A	3.40	3.30	3.20	9.00	8.55	8.25	-	-	
		W	610	610	610	5.450k	5.450k	5.450k	-	-	
	Input power	TOTAL W	-			6.060k	6.060k	6.060k	1.260k	6.800k	
		Annual consumption TOTAL kWh **	-	-	-	-	3030	-	-	-	
	EER/EER CLASS	TOTAL (W/W) *5 / (°A°-°G)	-	-	-	3.22	3.22 /A	3.22	4.52	3.09	
	Erp *6	Pdesign	kW	-	-	-	-	19.5	-	-	
		η _{s,c}	(W/W)	-	-	-	-	207.0	-	-	
		Annual consumption	kWh	-	-	-	-	-	-	-	
		Class		-	-	-	-	-	-	-	
		Power factor	%	-	-	-	92	92	92	-	-
		Noise indoor	dB-A (H/M/L)	46/44/41			-			-	-
	Power Level dB		78/76/73			-			-	-	
Noise outdoor	dB-A (H/L)	-			59/-			-	-		
	Power Level dB	-			77/-			-	-		
H E A T I N G	Capacity	kW	22.4	22.4	22.4	-	-	-	5.0	25.0	
		BTU/h	76400	76400	76400	-	-	-	17100	85300	
	Current	A	3.40	3.30	3.20	9.25	8.80	8.45	-	-	
		W	610	610	610	5.600k	5.600k	5.600k	-	-	
	Input power	TOTAL W	-			6.210k	6.210k	6.210k	1.050k	7.900k	
		COP/COP CLASS	TOTAL (W/W) *5 / (°A°-°G)	-	-	-	3.61	3.61 /A	3.61	4.76	3.16
	Erp *6	Pdesign at -10°C	kW	-	-	-	-	17.0	-	-	
		Tbivalent	°C	-	-	-	-	-10	-	-	
		η _{s,h}	(W/W)	-	-	-	-	141.3	-	-	
		Annual consumption	kWh	-	-	-	-	-	-	-	
		elbu(-10°C)	kW	-	-	-	-	0.00	-	-	
		Class		-	-	-	-	-	-	-	
	Power factor	%	-	-	-	92	92	92	-	-	
	Noise indoor	dB-A (H/M/L)	46/44/41			-			-	-	
Power Level dB		78/76/73			-			-	-		
Noise outdoor	dB-A (H/L)	-			61/-			-	-		
	Power Level dB	-			79/-			-	-		
EXTRA LOW TEMP Total capacity(kW)/Input power(W)/COP		-									
Max Current(A) / Max Input power(W)		5.70/1220	5.70/1220	5.60/1220	13.5/8.16k	13.5/8.59k	13.5/8.92k	-			
Starting current(A) (Cooling/Heating)		-	-	-	9.00/9.25	8.55/8.80	8.25/8.45	-			
Comp output(W)		-			4.20k	4.20k	4.20k	-			
Time Delay fuse max size(A)		15			30			-			
Network Impedance(ΩMAX.)		-			-			-			
Fan motor output (Indoor/Outdoor) W		560 × 2			120 × 2			-			
Moisture removal volume		L/h(Pt/h)			5.5 (5.5 × 1) (11.6)			-			
External static pressure		Pa			75 / (120/180)			-			
Indoor Air flow	Cooling	m ³ /min (m ³ /h) (H/M/L)	72.0/63.0/53.0 (4320)/(3780)/(3180)			-			-	-	
	Heating	m ³ /min (m ³ /h) (H/M/L)	72.0/63.0/53.0 (4320)/(3780)/(3180)			-			-	-	
Outdoor Air flow	Cooling	m ³ /min (m ³ /h)	-			164.0 (9840)			-	-	
	Heating	m ³ /min (m ³ /h)	-			164.0 (9840)			-	-	
Refrigerant type / amount g(oz)		-			R32 4.20k (148.2)			-			
Product dimension	Height	mm(inch)	486	(19-1/8)		1500	(59-1/16)		-		
	Width	mm(inch)	1456	(57-5/16)		980	(38-37/64)		-		
	Depth	mm(inch)	916	(36-1/16)		370	(14-9/16)		-		
Product dimension (Panel)		H×W×D mm, inch	-			-			-		
Packing dimension	Height	mm(inch)	610	(24-1/32)		1642	(64-41/64)		-		
	Width	mm(inch)	1646	(60-13/16)		1095	(43-7/64)		-		
	Depth	mm(inch)	1132	(44-9/16)		529	(20-53/64)		-		
Weight	(NET)	kg(lb)	86	(190)		117	(258)		-		
	(GROSS)	kg(lb)	106	(234)		129	(284)		-		
	Panel (NET)	kg(lb)	-	-		-	-		-		
Layers limit (actually)		4 (5)			1 (2)			-			
Operation condition	Cool (DBT)	18°C ~ 32°C			-15°C ~ 46°C			-			
	Heat (DBT)	16°C ~ 30°C			-20°C ~ 24°C			-			
Max Working Pressure HP/LP Mpa (bar)		4.15/2.70 (41.5/27.0)									
P I P I N G	Pipe diameter mm (inch)	(Liquid)Ø9.52(3/8) (Gas)Ø25.4(1)			(Liquid)Ø9.52(3/8) (Gas)Ø25.4(1)			-			
	Connecting method	(Liquid)flared type (Gas)brazing connection			(Liquid)flared type (Gas)brazing connection			-			
	Standard length m(ft)	7.5 (24.6)									
	Pipe length range m (ft)	5 ~ 90 m (16.4 ~ 295.3)									
	Indoor unit & Outdoor unit height difference m (ft)	30 m(OD located lower) / 30 m(OD located higher) (98.4 / 98.4)									
	Add gas amount g/m (oz/ft)	60 g/m (0.645)									
Pipe length for additional gas m (ft)		30m (98.4)									

*1 In case it is necessary to indicate the air flow volume in (l/s), the value in (m³/min.) shall be multiplied by 16.7 and rounded down the decimal point.

*2 If the EUROVENT Certified models can be operated under the "extra-low" temperature condition, -7°C dry bulb and -8°C wet-bulb temperatures with rated voltage 230V shall be used.

*3 Network Impedance shall be applicable for EUROPE and CHINA models.

*4 The annual consumption is calculated by multiplying the input power at 230V(400V) by an average of 500 hours per year in cooling mode.

*5 EER and COP classification is at 230V(400V) only in accordance with EU directive 2002/31/EC.

*6 η_{s,c} and η_{s,h} classification is at 230V(400V) only in accordance with EN-14825. For heating, η_{s,h} indicates the value of only Average heating season.

Single-Type

1-1. Unit Specifications

PZH2

High Static Pressure Ducted Type S-250PE3E5B / U-250PZH2E8

INDOOR		MODEL	S-250PE3E5B								
PANEL		MODEL									
OUTDOOR		MODEL				U-250PZH2E8					
Branch pipe		MODEL									
Performance test condition			ISO13253 / EN14511 / EN12102 / EN14825								
Power supply		Ø, Hz	1Ø 50Hz			3Ø 50Hz			Min	Max	
		V	220V	230V	240V	380V	400V	415V			
C O L U M N	Capacity	kW	23.2	23.2	23.2	-	-	-	6.1	27.0	
		BTU/h	79200	79200	79200	-	-	-	20800	92100	
	Current	A	4.30	4.20	4.10	10.8	10.3	9.90	-	-	
		W	830	830	830	6.630k	6.630k	6.630k	-	-	
	Input power	TOTAL W	-	-	-	7.460k	7.460k	7.460k	1.330k	9.200k	
		Annual consumption TOTAL kWh **	-	-	-	-	3730	-	-	-	
	EER/EER CLASS	TOTAL (W/W) *5 / (*A*-°G)	-	-	-	3.11	3.11 /B	3.11	4.59	2.93	
	Erp *6	Pdesign	kW	-	-	-	-	23.2	-	-	-
		η _{s,c}	(W/W)	-	-	-	-	190.6	-	-	-
		Annual consumption	kWh	-	-	-	-	-	-	-	-
		Class		-	-	-	-	-	-	-	-
		Power factor	%	-	-	-	93	93	93	-	-
		Noise indoor	dB-A (H/M/L)	47/45/42						-	-
	Power Level dB		79/77/74						-	-	
Noise outdoor	dB-A (H/L)				59/-			-	-		
	Power Level dB				78/-			-	-		
H E A T I N G	Capacity	kW	28.0	28.0	28.0	-	-	-	5.5	29.0	
		BTU/h	95500	95500	95500	-	-	-	18800	98900	
	Current	A	4.30	4.20	4.10	12.0	11.4	11.0	-	-	
		W	830	830	830	7.380k	7.380k	7.380k	-	-	
	Input power	TOTAL W	-	-	-	8.210k	8.210k	8.210k	1.100k	9.500k	
		COP/COP CLASS	TOTAL (W/W) *5 / (*A*-°G)	-	-	-	3.41	3.41 /B	3.41	5.00	3.05
	Erp *6	Pdesign at -10°C	kW	-	-	-	-	20.0	-	-	-
		Tbivalent	°C	-	-	-	-	-10	-	-	-
		η _{s,h}	(W/W)	-	-	-	-	142.7	-	-	-
		Annual consumption	kWh	-	-	-	-	-	-	-	-
		elbu(-10°C)	kW	-	-	-	-	0.00	-	-	-
		Class		-	-	-	-	-	-	-	-
	Power factor	%	-	-	-	93	93	93	-	-	
	Noise indoor	dB-A (H/M/L)	47/45/42						-	-	
Power Level dB		79/77/74						-	-		
Noise outdoor	dB-A (H/L)				63/-			-	-		
	Power Level dB				82/-			-	-		
EXTRA LOW TEMP Total capacity(kW)/Input power(W)/COP											
Max Current(A) / Max Input power(W)		6.60/1440	6.40/1440	6.30/1440	18.5/11.3k	18.5/11.9k	18.5/12.4k				
Starting current(A) (Cooling/Heating)		-	-	-	10.8/12.0	10.3/11.4	9.90/11.0				
Comp output(W)					5.50k	5.50k	5.50k				
Time Delay fuse max size(A)		15			30						
Network Impedance(ΩMAX.)											
Fan motor output (Indoor/Outdoor) W		750 × 2			120 × 2						
Moisture removal volume		L/h(Pt/h)			6.8 (6.8 × 1) (14.3)						
External static pressure		Pa			75 / (130/200)						
Indoor Air flow	Cooling	m ³ /min (m ³ /h) (H/M/L)	84.0/72.0/59.0 (5040)/(4320)/(3450)								
	Heating	m ³ /min (m ³ /h) (H/M/L)	84.0/72.0/59.0 (5040)/(4320)/(3450)								
Outdoor Air flow	Cooling	m ³ /min (m ³ /h)				160.0 (9600)					
	Heating	m ³ /min (m ³ /h)				160.0 (9600)					
Refrigerant type / amount g(oz)					R32 5.20k (183.4)						
Product dimension	Height	mm(inch)	486	(19-1/8)		1500	(59-1/16)				
	Width	mm(inch)	1456	(57-5/16)		980	(38-37/64)				
	Depth	mm(inch)	916	(36-1/16)		370	(14-9/16)				
Product dimension (Panel)		H×W×D mm, inch									
Packing dimension	Height	mm(inch)	610	(24-1/32)		1642	(64-41/64)				
	Width	mm(inch)	1646	(60-13/16)		1095	(43-7/64)				
	Depth	mm(inch)	1132	(44-9/16)		529	(20-53/64)				
Weight	(NET)	kg(lb)	88	(195)		128	(282)				
	(GROSS)	kg(lb)	108	(239)		140	(309)				
	Panel (NET)	kg(lb)	-			-					
Layers limit (actually)		4 (5)			1 (2)						
Operation condition	Cool (DBT)	18°C ~ 32°C			-15°C ~ 46°C						
	Heat (DBT)	16°C ~ 30°C			-20°C ~ 24°C						
Max Working Pressure HP/LP Mpa (bar)		4.15/2.70 (41.5/27.0)									
P I P I N G	Pipe diameter mm (inch)	(Liquid)Ø12.7(1/2) (Gas)Ø25.4(1)			(Liquid)Ø12.7(1/2) (Gas)Ø25.4(1)						
	Connecting method	(Liquid)flared type (Gas)brazing connection			(Liquid)flared type (Gas)brazing connection						
	Standard length m(ft)	7.5 (24.6)									
	Pipe length range m (ft)	5 ~ 60 m (16.4 ~ 196.9)									
	Indoor unit & Outdoor unit height difference m (ft)	30 m(OD located lower) / 30 m(OD located higher) (98.4 / 98.4)									
	Add gas amount g/m (oz/ft)	80 g/m (0.860)									
Pipe length for additional gas m (ft)		30m (98.4)									

*1 In case it is necessary to indicate the air flow volume in (l/s), the value in (m³/min.) shall be multiplied by 16.7 and rounded down the decimal point.

*2 If the EUROVENT Certified models can be operated under the "extra-low" temperature condition, -7°C dry bulb and -8°C wet-bulb temperatures with rated voltage 230V shall be used.

*3 Network Impedance shall be applicable for EUROPE and CHINA models.

*4 The annual consumption is calculated by multiplying the input power at 230V(400V) by an average of 500 hours per year in cooling mode.

*5 EER and COP classification is at 230V(400V) only in accordance with EU directive 2002/31/EC.

*6 η_{s,c} and η_{s,h} classification is at 230V(400V) only in accordance with EN-14825. For heating, η_{s,h} indicates the value of only Average heating season.

Twin-Type

1-1. Unit Specifications

PZH2

4-Way Cassette Type S-100PU2E5B ×2 / U-200PZH2E8

INDOOR		MODEL	S-100PU2E5B ×2								
PANEL		MODEL	Standard type:CZ-KPU3 / ECONAVI type:CZ-KPU3A								
OUTDOOR		MODEL				U-200PZH2E8					
Branch pipe		MODEL				CZ-P680BK2					
Performance test condition		ISO5151 / EN14511 / EN12102 / EN14825									
Power supply		Ø, Hz	1Ø 50Hz			3Ø 50Hz			Min	Max	
		V	220V	230V	240V	380V	400V	415V			
C O L I N G	Capacity	kW	20.0	20.0	20.0	-	-	-	5.7	22.4	
		BTU/h	68200	68200	68200	-	-	-	19400	76400	
	Current	A	0.82 ×2	0.79 ×2	0.76 ×2	9.10	8.65	8.35	-	-	
		W	100 ×2	100 ×2	100 ×2	5.510k	5.510k	5.510k	-	-	
	Input power	TOTAL W				5.710k	5.710k	5.710k	1.170k	7.100k	
		Annual consumption	TOTAL kWh **	-	-	-	-	2855	-	-	-
	EER/EER CLASS	TOTAL (W/W) ⁴⁵ / (°A°-°G)	-	-	-	3.50	3.50 /A	3.50	4.87	3.15	
	Erp ₆₀	Pdesign	kW	-	-	-	-	20.0	-	-	-
		η _{s,c}	(W/W)	-	-	-	-	326.2	-	-	-
	Annual consumption	kWh	-	-	-	-	-	-	-	-	-
		Class	-	-	-	-	-	-	-	-	-
	Power factor	%	-	-	-	92	92	92	-	-	
	Noise indoor *7	dB-A (H/M/L)	45/38/32						-	-	-
		Power Level dB	60/53/47						-	-	-
Noise outdoor	dB-A (H/L)				59/-			-	-	-	
	Power Level dB				77/-			-	-	-	
H E A T I N G	Capacity	kW	22.4	22.4	22.4	-	-	-	5.0	25.0	
		BTU/h	76400	76400	76400	-	-	-	17100	85300	
	Current	A	0.81 ×2	0.78 ×2	0.75 ×2	8.35	7.95	7.65	-	-	
		W	95 ×2	95 ×2	95 ×2	5.070k	5.070k	5.070k	-	-	
	Input power	TOTAL W				5.260k	5.260k	5.260k	960	7.900k	
		COP/COP CLASS	TOTAL (W/W) ⁴⁵ / (°A°-°G)	-	-	-	4.26	4.26 /A	4.26	5.21	3.16
	Erp ₆₀	Pdesign at -10°C	kW	-	-	-	-	18.0	-	-	-
		Tbivalent	°C	-	-	-	-	-10	-	-	-
	Annual consumption	(W/W)	-	-	-	-	-	182.2	-	-	-
		kWh	-	-	-	-	-	-	-	-	-
	elbu(-10°C)	kW	-	-	-	-	-	0.00	-	-	-
		Class	-	-	-	-	-	-	-	-	-
	Power factor	%	-	-	-	92	92	92	-	-	
	Noise indoor *7	dB-A (H/M/L)	45/38/32						-	-	-
Power Level dB		60/53/47						-	-	-	
Noise outdoor	dB-A (H/L)				61/-			-	-	-	
	Power Level dB				79/-			-	-	-	
EXTRA LOW TEMP Total capacity(kW)/input power(W)/COP											
Max Current(A) / Max Input power(W)		0.82/100 ×2	0.79/100 ×2	0.76/100 ×2	13.5/8.16k	13.5/8.59k	13.5/8.92k				
Starting current(A) (Cooling/Heating)		-	-	-	9.10/8.35	8.65/7.95	8.35/7.65				
Comp output(W)					4.20k	4.20k	4.20k				
Time Delay fuse max size(A)		5			30						
Network Impedance(ΩMAX.)											
Fan motor output (Indoor/Outdoor) W		90			120 × 2						
Moisture removal volume		L/h(Pt/h)			5.4 (2.7 ×2) (11.3)						
External static pressure		Pa									
Indoor Air flow *7	Cooling	m ³ /min (m ³ /h) (H/M/L)	36.0×2/26.0×2/18.0×2 (2160)×2/(1560)×2/(1080)×2						-	-	
	Heating	m ³ /min (m ³ /h) (H/M/L)	36.0×2/26.0×2/18.0×2 (2160)×2/(1560)×2/(1080)×2						-	-	
Outdoor Air flow	Cooling	m ³ /min (m ³ /h)				164.0 (9840)			-	-	
	Heating	m ³ /min (m ³ /h)				164.0 (9840)			-	-	
Refrigerant type / amount g(oz)					R32 4.20k (148.2)						
Product dimension	Height	mm(inch)	319	(12-9/16)		1500	(59-1/16)		-		
	Width	mm(inch)	840	(33-5/64)		980	(38-37/64)		-		
	Depth	mm(inch)	840	(33-5/64)		370	(14-9/16)		-		
Product dimension (Panel)		H×W×D mm, inch	33.5×950×950 (1-11/32×37-13/32×37-13/32)								
Packing dimension	Height	mm(inch)	365	(14-3/8)		1642	(64-41/64)		-		
	Width	mm(inch)	898	(35-3/8)		1095	(43-7/64)		-		
	Depth	mm(inch)	898	(35-3/8)		529	(20-53/64)		-		
Weight	(NET)	kg(lb)	25	(55)		117	(258)		-		
	(GROSS)	kg(lb)	32	(71)		129	(284)		-		
	Panel (NET)	kg(lb)	5	(11)		-			-		
Layers limit (actually)		11 (12)			1 (2)						
Operation condition	Cool (DBT)	18°C ~ 32°C			-15°C ~ 46°C						
	Heat (DBT)	16°C ~ 30°C			-20°C ~ 24°C						
Max Working Pressure HP/LP Mpa (bar)		4.15/2.70 (41.5/27.0)									
P I P I N G	Pipe diameter mm (inch)	(Liquid)Ø9.52(3/8) (Gas)Ø15.88(5/8)			(Liquid)Ø9.52(3/8) (Gas)Ø25.4(1)						
	Connecting method	flared type			(Liquid)flared type (Gas)brazing connection						
	Standard length m(ft)				7.5 (24.6)						
	Pipe length range m (ft)				5 ~ 80 m (16.4 ~ 262.5)						
	Indoor unit & Outdoor unit height difference m (ft)				30 m(OD located lower) / 30 m(OD located higher) (98.4 / 98.4)						
Add gas amount g/m (oz/ft)					60 g/m (0.645)						
Pipe length for additional gas m (ft)					30m (98.4)						

*1 In case it is necessary to indicate the air flow volume in (l/s), the value in (m³/min.) shall be multiplied by 16.7 and rounded down the decimal point.

*2 If the EUROVENT Certified models can be operated under the "extra-low" temperature condition, -7°C dry bulb and -8°C wet-bulb temperatures with rated voltage 230V shall be used.

*3 Network Impedance shall be applicable for EUROPE and CHINA models.

*4 The annual consumption is calculated by multiplying the input power at 230V(400V) by an average of 500 hours per year in cooling mode.

*5 EER and COP classification is at 230V(400V) only in accordance with EU directive 2002/31/EC.

*6 η_{s,c} and η_{s,h} classification is at 230V(400V) only in accordance with EN-14825. For heating, η_{s,h} indicates the value of only Average heating season.

*7 H:High at setting 5 stage (Level 5), M:Middle at setting 5 stage (Level 3), L:Low at setting 5 stage (Level 1)

Triple-Type

1-1. Unit Specifications

PZH2

4-Way Cassette Type S-71PU2E5B ×3 / U-200PZH2E8

INDOOR		MODEL	S-71PU2E5B ×3			-			-		
PANEL		MODEL	Standard type:CZ-KPU3 / ECONAVI type:CZ-KPU3A			-			-		
OUTDOOR		MODEL	-			U-200PZH2E8			-		
Branch pipe		MODEL	-			CZ-P3HPC2			-		
Performance test condition		ISO5151 / EN14511 / EN12102 / EN14825									
Power supply		Ø, Hz	1Ø 50Hz			3Ø 50Hz			Min	Max	
		V	220V	230V	240V	380V	400V	415V			
C O O L I N G	Capacity	kW	20.0	20.0	20.0	-	-	-	5.7	22.4	
		BTU/h	68200	68200	68200	-	-	-	19400	76400	
	Current	A	0.40 ×3	0.39 ×3	0.38 ×3	9.20	8.75	8.45	-	-	
		W	42 ×3	42 ×3	42 ×3	5.584k	5.584k	5.584k	-	-	
	Input power	TOTAL W	-			5.710k	5.710k	5.710k	1.170k	7.100k	
		Annual consumption	TOTAL kWh **	-	-	-	-	2855	-	-	-
	EER/EER CLASS	TOTAL (W/W) ¹⁵ / (°A°-°G)	-	-	-	3.50	3.50 /A	3.50	4.87	3.15	
	Pdesign	kW	-	-	-	-	20.0	-	-	-	
	Erp ₆₀	η _{s,c}	(W/W)	-	-	-	-	326.2	-	-	-
		Annual consumption	kWh	-	-	-	-	-	-	-	-
	Class		-	-	-	-	-	-	-	-	
	Power factor	%	-	-	-	92	92	92	-	-	
Noise indoor *7	dB-A (H/M/L)	37/31/28			-			-	-		
	Power Level dB	52/46/43			-			-	-		
Noise outdoor	dB-A (H/L)	-			59/-			-	-		
	Power Level dB	-			77/-			-	-		
H E A T I N G	Capacity	kW	22.4	22.4	22.4	-	-	-	5.0	25.0	
		BTU/h	76400	76400	76400	-	-	-	17100	85300	
	Current	A	0.39 ×3	0.38 ×3	0.37 ×3	8.50	8.05	7.75	-	-	
		W	40 ×3	40 ×3	40 ×3	5.140k	5.140k	5.140k	-	-	
	Input power	TOTAL W	-			5.260k	5.260k	5.260k	960	7.900k	
		COP/COP CLASS	TOTAL (W/W) ¹⁵ / (°A°-°G)	-	-	-	4.26	4.26 /A	4.26	5.21	3.16
	Pdesign at -10°C	kW	-	-	-	-	18.0	-	-	-	
		Tbivalent °C	-	-	-	-	-10	-	-	-	
	Erp ₆₀	η _{s,h}	(W/W)	-	-	-	-	182.2	-	-	
		Annual consumption	kWh	-	-	-	-	-	-	-	
	elbu(-10°C)	kW	-	-	-	-	0.00	-	-	-	
	Class		-	-	-	-	-	-	-	-	
Power factor	%	-	-	-	92	92	92	-	-		
Noise indoor *7	dB-A (H/M/L)	37/31/28			-			-	-		
	Power Level dB	52/46/43			-			-	-		
Noise outdoor	dB-A (H/L)	-			61/-			-	-		
	Power Level dB	-			79/-			-	-		
EXTRA LOW TEMP Total capacity(kW)/Input power(W)/COP		-									
Max Current(A) / Max Input power(W)		0.40/42 ×3	0.39/42 ×3	0.38/42 ×3	13.5/8.16k	13.5/8.59k	13.5/8.92k	-			
Starting current(A) (Cooling/Heating)		-	-	-	9.20/8.50	8.75/8.05	8.45/7.75	-			
Comp output(W)		-			4.20k	4.20k	4.20k	-			
Time Delay fuse max size(A)		5			30			-			
Network Impedance(ΩMAX.)		-			-			-			
Fan motor output (Indoor/Outdoor) W		60			120 × 2			-			
Moisture removal volume		L/h(Pt/h)			7.5 (2.5 ×3) (15.8)			-			
External static pressure		Pa			-			-			
Indoor Air flow *7	Cooling	m ³ /min (m ³ /h) (H/M/L)	22.0×3/16.0×3/13.0×3 (1320)×3/(960)×3/(780)×3			-			-	-	
	Heating	m ³ /min (m ³ /h) (H/M/L)	22.0×3/16.0×3/13.0×3 (1320)×3/(960)×3/(780)×3			-			-	-	
Outdoor Air flow	Cooling	m ³ /min (m ³ /h)	-			164.0 (9840)			-	-	
	Heating	m ³ /min (m ³ /h)	-			164.0 (9840)			-	-	
Refrigerant type / amount g(oz)		-			R32 4.20k (148.2)			-			
Product dimension	Height	mm(inch)	256	(10-5/64)		1500	(59-1/16)		-		
	Width	mm(inch)	840	(33-5/64)		980	(38-37/64)		-		
	Depth	mm(inch)	840	(33-5/64)		370	(14-9/16)		-		
Product dimension (Panel)		H×W×D mm, inch	33.5×950×950		(1-11/32×37-13/32×37-13/32)		-				
Packing dimension	Height	mm(inch)	302	(11-57/64)		1642	(64-41/64)		-		
	Width	mm(inch)	898	(35-3/8)		1095	(43-7/64)		-		
	Depth	mm(inch)	898	(35-3/8)		529	(20-53/64)		-		
Weight	(NET)	kg(lb)	20	(44)		117	(258)		-		
	(GROSS)	kg(lb)	27	(60)		129	(284)		-		
	Panel (NET)	kg(lb)	5	(11)		-	-		-		
Layers limit (actually)		11 (12)			1 (2)			-			
Operation condition	Cool (DBT)	18°C ~ 32°C			-15°C ~ 46°C			-			
	Heat (DBT)	16°C ~ 30°C			-20°C ~ 24°C			-			
Max Working Pressure HP/LP Mpa (bar)		4.15/2.70 (41.5/27.0)									
P I P I N G	Pipe diameter mm (inch)	(Liquid)Ø9.52(3/8) (Gas)Ø15.88(5/8)			(Liquid)Ø9.52(3/8) (Gas)Ø25.4(1)			-			
	Connecting method	flared type			(Liquid)flared type (Gas)brazing connection			-			
	Standard length m(ft)	7.5 (24.6)			-			-			
	Pipe length range m (ft)	5 ~ 80 m (16.4 ~ 262.5)			-			-			
	Indoor unit & Outdoor unit height difference m (ft)	30 m(OD located lower) / 30 m(OD located higher) (98.4 / 98.4)			-			-			
Add gas amount g/m (oz/ft)	60 g/m (0.645)			-			-				
Pipe length for additional gas m (ft)	30m (98.4)			-			-				

*1 In case it is necessary to indicate the air flow volume in (l/s), the value in (m³/min.) shall be multiplied by 16.7 and rounded down the decimal point.
 *2 If the EUROVENT Certified models can be operated under the "extra-low" temperature condition, -7°C dry bulb and -8°C wet-bulb temperatures with rated voltage 230V shall be used.
 *3 Network Impedance shall be applicable for EUROPE and CHINA models.
 *4 The annual consumption is calculated by multiplying the input power at 230V(400V) by an average of 500 hours per year in cooling mode.
 *5 EER and COP classification is at 230V(400V) only in accordance with EU directive 2002/31/EC.
 *6 η_{s,c} and η_{s,h} classification is at 230V(400V) only in accordance with EN-14825. For heating, η_{s,h} indicates the value of only Average heating season.
 *7 H:High at setting 5 stage (Level 5), M:Middle at setting 5 stage (Level 3), L:Low at setting 5 stage (Level 1)

Double Twin-Type

1-1. Unit Specifications

PZH2

4-Way Cassette Type S-50PU2E5B ×4 / U-200PZH2E8

INDOOR		MODEL	S-50PU2E5B ×4			-			-	
PANEL		MODEL	Standard type:CZ-KPU3 / ECONAVI type:CZ-KPU3A			-			-	
OUTDOOR		MODEL	-			U-200PZH2E8			-	
Branch pipe		MODEL	-			CZ-P680BK2 + CZ-P155BK1×2			-	
Performance test condition		ISO5151 / EN14511 / EN12102 / EN14825								
Power supply		Ø, Hz	1Ø 50Hz			3Ø 50Hz			Min	Max
		V	220V	230V	240V	380V	400V	415V		
C O O L I N G	Capacity	kW	20.0	20.0	20.0	-	-	-	5.7	22.4
		BTU/h	68200	68200	68200	-	-	-	19400	76400
	Current	A	0.27 ×4	0.26 ×4	0.25 ×4	9.25	8.80	8.45	-	-
		W	29 ×4	29 ×4	29 ×4	5.594k	5.594k	5.594k	-	-
	Input power	TOTAL W	-			5.710k	5.710k	5.710k	1.170k	7.100k
		Annual consumption	TOTAL kWh **	-	-	-	-	2855	-	-
	EER/EER CLASS	TOTAL (W/W) ¹⁵ / (°A°-°G)	-	-	-	3.50	3.50 /A	3.50	4.87	3.15
	Erp ¹⁶	Pdesign	kW	-	-	-	-	20.0	-	-
		η _{s,c}	(W/W)	-	-	-	-	326.2	-	-
	Annual consumption	kWh	-	-	-	-	-	-	-	-
		Class	-	-	-	-	-	-	-	-
	Power factor	%	-	-	-	92	92	92	-	-
	Noise indoor *7	dB-A (H/M/L)	32/29/27			-			-	-
		Power Level dB	47/44/42			-			-	-
Noise outdoor	dB-A (H/L)	-			59/-			-	-	
	Power Level dB	-			77/-			-	-	
H E A T I N G	Capacity	kW	22.4	22.4	22.4	-	-	-	5.0	25.0
		BTU/h	76400	76400	76400	-	-	-	17100	85300
	Current	A	0.26 ×4	0.25 ×4	0.24 ×4	8.50	8.10	7.80	-	-
		W	27 ×4	27 ×4	27 ×4	5.152k	5.152k	5.152k	-	-
	Input power	TOTAL W	-			5.260k	5.260k	5.260k	960	7.900k
		COP/COP CLASS	TOTAL (W/W) ¹⁵ / (°A°-°G)	-	-	-	4.26	4.26 /A	4.26	5.21
	Pdesign at -10°C	kW	-	-	-	-	18.0	-	-	-
		Tbivalent °C	-	-	-	-	-10	-	-	-
	Erp ¹⁶	η _{s,h}	(W/W)	-	-	-	-	182.2	-	-
		Annual consumption	kWh	-	-	-	-	-	-	-
	elbu(-10°C)	kW	-	-	-	-	0.00	-	-	-
		Class	-	-	-	-	-	-	-	-
	Power factor	%	-	-	-	92	92	92	-	-
	Noise indoor *7	dB-A (H/M/L)	32/29/27			-			-	-
Power Level dB		47/44/42			-			-	-	
Noise outdoor	dB-A (H/L)	-			61/-			-	-	
	Power Level dB	-			79/-			-	-	
EXTRA LOW TEMP	Total capacity(kW)/Input power(W)/COP	-								
Max Current(A) / Max Input power(W)		0.27/29 ×4	0.26/29 ×4	0.25/29 ×4	13.5/8.16k	13.5/8.59k	13.5/8.92k	-		
Starting current(A) (Cooling/Heating)		-	-	-	9.25/8.50	8.80/8.10	8.45/7.80	-		
Comp output(W)		-			4.20k	4.20k	4.20k	-		
Time Delay fuse max size(A)		5			30			-		
Network Impedance(ΩMAX.)		-			-			-		
Fan motor output (Indoor/Outdoor) W		60			120 × 2			-		
Moisture removal volume	L/h(Pt/h)	6.4 (1.6 ×4) (13.4)			-			-		
External static pressure	Pa	-			-			-		
Indoor Air flow *7	Cooling	m ³ /min (m ³ /h) (H/M/L)	16.5×4/13.5×4/11.5×4 (990)×4/(810)×4/(690)×4			-			-	-
	Heating	m ³ /min (m ³ /h) (H/M/L)	16.5×4/13.5×4/11.5×4 (990)×4/(810)×4/(690)×4			-			-	-
Outdoor Air flow	Cooling	m ³ /min (m ³ /h)	-			164.0 (9840)			-	-
	Heating	m ³ /min (m ³ /h)	-			164.0 (9840)			-	-
Refrigerant type / amount g(oz)		-			R32 4.20k (148.2)			-		
Product dimension	Height mm(inch)	256	(10-5/64)			1500	(59-1/16)			
	Width mm(inch)	840	(33-5/64)			980	(38-37/64)			
	Depth mm(inch)	840	(33-5/64)			370	(14-9/16)			
Product dimension (Panel)	H×W×D mm, inch	33.5×950×950		(1-11/32×37-13/32×37-13/32)		-				
Packing dimension	Height mm(inch)	302	(11-57/64)			1642	(64-41/64)			
	Width mm(inch)	898	(35-3/8)			1095	(43-7/64)			
	Depth mm(inch)	898	(35-3/8)			529	(20-53/64)			
Weight	(NET) kg(lb)	19	(42)			117	(258)			
	(GROSS) kg(lb)	26	(57)			129	(284)			
	Panel (NET) kg(lb)	5	(11)			-	-			
Layers limit (actually)		11 (12)			1 (2)			-		
Operation condition	Cool (DBT)	18°C ~ 32°C			-15°C ~ 46°C			-		
	Heat (DBT)	16°C ~ 30°C			-20°C ~ 24°C			-		
Max Working Pressure HP/LP Mpa (bar)		4.15/2.70 (41.5/27.0)								
P I P I N G	Pipe diameter mm (inch)	(Liquid)Ø6.35(1/4) (Gas)Ø12.7(1/2)			(Liquid)Ø9.52(3/8) (Gas)Ø25.4(1)			-		
	Connecting method	flared type			(Liquid)flared type (Gas)brazing connection			-		
	Standard length m(ft)	-			7.5 (24.6)			-		
	Pipe length range m (ft)	-			5 ~ 80 m (16.4 ~ 262.5)			-		
Indoor unit & Outdoor unit height difference m (ft)		30 m(OD located lower) / 30 m(OD located higher) (98.4 / 98.4)								
Add gas amount g/m (oz/ft)		60 g/m (0.645)								
Pipe length for additional gas m (ft)		30m (98.4)								

*1 In case it is necessary to indicate the air flow volume in (l/s), the value in (m³/min.) shall be multiplied by 16.7 and rounded down the decimal point.

*2 If the EUROVENT Certified models can be operated under the "extra-low" temperature condition, -7°C dry bulb and -8°C wet-bulb temperatures with rated voltage 230V shall be used.

*3 Network Impedance shall be applicable for EUROPE and CHINA models.

*4 The annual consumption is calculated by multiplying the input power at 230V(400V) by an average of 500 hours per year in cooling mode.

*5 EER and COP classification is at 230V(400V) only in accordance with EU directive 2002/31/EC.

*6 η_{s,c} and η_{s,h} classification is at 230V(400V) only in accordance with EN-14825. For heating, η_{s,h} indicates the value of only Average heating season.

*7 H:High at setting 5 stage (Level 5), M:Middle at setting 5 stage (Level 3), L:Low at setting 5 stage (Level 1)

Twin-Type

1-1. Unit Specifications

PZH2

4-Way Cassette Type S-125PU2E5B x2 / U-250PZH2E8

INDOOR		MODEL	S-125PU2E5B x2			-			-	
PANEL		MODEL	Standard type:CZ-KPU3 / ECONAVI type:CZ-KPU3A			-			-	
OUTDOOR		MODEL	-			U-250PZH2E8			-	
Branch pipe		MODEL	-			CZ-P680BK2			-	
Performance test condition		ISO5151 / EN14511 / EN12102 / EN14825								
Power supply		Ø, Hz	1Ø 50Hz			3Ø 50Hz			Min	Max
		V	220V	230V	240V	380V	400V	415V		
C O O L I N G	Capacity	kW	25.0	25.0	25.0	-	-	-	6.1	28.0
		BTU/h	85300	85300	85300	-	-	-	20800	95500
	Current	A	0.91 x2	0.88 x2	0.85 x2	12.8	12.1	11.7	-	-
		W	110 x2	110 x2	110 x2	7.840k	7.840k	7.840k	-	-
	Input power	TOTAL W	-			8.060k	8.060k	8.060k	1.200k	9.720k
		Annual consumption	TOTAL kWh **	-	-	-	-	4030	-	-
	EER/EER CLASS	TOTAL (W/W) ¹⁵ / (A ² -°C)	-	-	-	3.10	3.10 /B	3.10	5.08	2.88
	Erp ¹⁶	Pdesign	kW	-	-	-	-	25.0	-	-
		η _{s,c}	(W/W)	-	-	-	-	296.2	-	-
	Annual consumption	kWh	-	-	-	-	-	-	-	-
		Class	-	-	-	-	-	-	-	-
	Power factor	%	-	-	-	93	93	93	-	-
	Noise indoor ¹⁷	dB-A (H/M/L)	46/39/33			-			-	-
		Power Level dB	61/54/48			-			-	-
Noise outdoor	dB-A (H/L)	-			59/-			-	-	
	Power Level dB	-			78/-			-	-	
H E A T I N G	Capacity	kW	28.0	28.0	28.0	-	-	-	5.5	31.5
		BTU/h	95500	95500	95500	-	-	-	18800	107500
	Current	A	0.90 x2	0.87 x2	0.84 x2	11.4	10.8	10.4	-	-
		W	105 x2	105 x2	105 x2	6.990k	6.990k	6.990k	-	-
	Input power	TOTAL W	-			7.200k	7.200k	7.200k	1.000k	10.100k
		COP/COP CLASS	TOTAL (W/W) ¹⁵ / (A ² -°C)	-	-	-	3.89	3.89 /A	3.89	5.50
	Pdesign at -10°C	kW	-	-	-	-	20.0	-	-	-
		Tbivalent °C	-	-	-	-	-10	-	-	-
	Erp ¹⁶	η _{s,h}	(W/W)	-	-	-	-	174.1	-	-
		Annual consumption	kWh	-	-	-	-	-	-	-
	elbu(-10°C)	kW	-	-	-	-	0.00	-	-	-
		Class	-	-	-	-	-	-	-	-
	Power factor	%	-	-	-	93	93	93	-	-
	Noise indoor ¹⁷	dB-A (H/M/L)	46/39/33			-			-	-
Power Level dB		61/54/48			-			-	-	
Noise outdoor	dB-A (H/L)	-			63/-			-	-	
	Power Level dB	-			82/-			-	-	
EXTRA LOW TEMP	Total capacity(kW)/Input power(W)/COP	-								
Max Current(A) / Max Input power(W)		0.91/110 x2	0.88/110 x2	0.85/110 x2	18.5/11.3k	18.5/11.9k	18.5/12.4k	-		
Starting current(A) (Cooling/Heating)		-	-	-	12.8/11.4	12.1/10.8	11.7/10.4	-		
Comp output(W)		-			5.50k	5.50k	5.50k	-		
Time Delay fuse max size(A)		5			30			-		
Network Impedance(ΩMAX.)		-			-			-		
Fan motor output (Indoor/Outdoor) W		90			120 x 2			-		
Moisture removal volume	L/h(Pt/h)	9.6 (4.8 x2) (20.2)			-			-		
External static pressure	Pa	-			-			-		
Indoor Air flow ¹⁷	Cooling	m ³ /min (m ³ /h) (H/M/L)	37.0x2/27.0x2/19.0x2 (2220)x2/(1620)x2/(1140)x2			-			-	-
	Heating	m ³ /min (m ³ /h) (H/M/L)	37.0x2/27.0x2/19.0x2 (2220)x2/(1620)x2/(1140)x2			-			-	-
Outdoor Air flow	Cooling	m ³ /min (m ³ /h)	-			160.0 (9600)			-	-
	Heating	m ³ /min (m ³ /h)	-			160.0 (9600)			-	-
Refrigerant type / amount g(oz)		-			R32 5.20k (183.4)			-		
Product dimension	Height	mm(inch)	319	(12-9/16)		1500	(59-1/16)		-	
	Width	mm(inch)	840	(33-5/64)		980	(38-37/64)		-	
	Depth	mm(inch)	840	(33-5/64)		370	(14-9/16)		-	
Product dimension (Panel)	HxWxD mm, inch	33.5x950x950		(1-11/32x37-13/32x37-13/32)		-		-		
Packing dimension	Height	mm(inch)	365	(14-3/8)		1642	(64-41/64)		-	
	Width	mm(inch)	898	(35-3/8)		1095	(43-7/64)		-	
	Depth	mm(inch)	898	(35-3/8)		529	(20-53/64)		-	
Weight	(NET)	kg(lb)	25	(55)		128	(282)		-	
	(GROSS)	kg(lb)	32	(71)		140	(309)		-	
	Panel (NET)	kg(lb)	5	(11)		-	-		-	
Layers limit (actually)		11 (12)			1 (2)			-		
Operation condition	Cool (DBT)	18°C ~ 32°C			-15°C ~ 46°C			-		
	Heat (DBT)	16°C ~ 30°C			-20°C ~ 24°C			-		
Max Working Pressure HP/LP Mpa (bar)		4.15/2.70 (41.5/27.0)								
P I P I N G	Pipe diameter mm (inch)	(Liquid)Ø9.52(3/8) (Gas)Ø15.88(5/8)			(Liquid)Ø12.7(1/2) (Gas)Ø25.4(1)			-		
	Connecting method	flared type			(Liquid)flared type (Gas)brazing connection			-		
	Standard length m(ft)	-			7.5 (24.6)			-		
	Pipe length range m (ft)	-			5 ~ 60 m (16.4 ~ 196.9)			-		
	Indoor unit & Outdoor unit height difference m (ft)	-			30 m(OD located lower) / 30 m(OD located higher) (98.4 / 98.4)			-		
Add gas amount g/m (oz/ft)	-			80 g/m (0.86ft)			-			
Pipe length for additional gas m (ft)	-			30m (98.4)			-			

*1 In case it is necessary to indicate the air flow volume in (l/s), the value in (m³/min.) shall be multiplied by 16.7 and rounded down the decimal point.

*2 If the EUROVENT Certified models can be operated under the "extra-low" temperature condition, -7°C dry bulb and -8°C wet-bulb temperatures with rated voltage 230V shall be used.

*3 Network Impedance shall be applicable for EUROPE and CHINA models.

*4 The annual consumption is calculated by multiplying the input power at 230V(400V) by an average of 500 hours per year in cooling mode.

*5 EER and COP classification is at 230V(400V) only in accordance with EU directive 2002/31/EC.

*6 η_{s,c} and η_{s,h} classification is at 230V(400V) only in accordance with EN-14825. For heating, η_{s,h} indicates the value of only Average heating season.

*7 H:High at setting 5 stage (Level 5), M:Middle at setting 5 stage (Level 3), L:Low at setting 5 stage (Level 1)

Double Twin-Type

1-1. Unit Specifications

PZH2

4-Way Cassette Type S-60PU2E5B ×4 / U-250PZH2E8

INDOOR		MODEL	S-60PU2E5B ×4			-			-	
PANEL		MODEL	Standard type:CZ-KPU3 / ECONAVI type:CZ-KPU3A			-			-	
OUTDOOR		MODEL	-			U-250PZH2E8			-	
Branch pipe		MODEL	-			CZ-P680BK2 + CZ-P155BK1×2			-	
Performance test condition		ISO5151 / EN14511 / EN12102 / EN14825								
Power supply		Ø, Hz	1Ø 50Hz			3Ø 50Hz			Min	Max
		V	220V	230V	240V	380V	400V	415V		
C O O L I N G	Capacity	kW	25.0	25.0	25.0	-	-	-	6.1	28.0
		BTU/h	85300	85300	85300	-	-	-	20800	95500
	Current	A	0.36 ×4	0.35 ×4	0.34 ×4	12.9	12.2	11.8	-	-
		W	38 ×4	38 ×4	38 ×4	7.908k	7.908k	7.908k	-	-
	Input power	TOTAL W	-			8.060k	8.060k	8.060k	1.200k	9.720k
		Annual consumption	TOTAL kWh **	-	-	-	-	4030	-	-
	EER/EER CLASS	TOTAL (W/W) ⁴⁵ / (°A~°G)	-	-	-	3.10	3.10 /B	3.10	5.08	2.88
	Erp ₆₀	Pdesign	kW	-	-	-	-	25.0	-	-
		η _{s,c}	(W/W)	-	-	-	-	296.2	-	-
	Annual consumption	kWh	-	-	-	-	-	-	-	-
		Class	-	-	-	-	-	-	-	-
	Power factor	%	-	-	-	93	93	93	-	-
	Noise indoor *7	dB-A (H/M/L)	36/31/28			-			-	-
		Power Level dB	51/46/43			-			-	-
Noise outdoor	dB-A (H/L)	-			59/-			-	-	
	Power Level dB	-			78/-			-	-	
H E A T I N G	Capacity	kW	28.0	28.0	28.0	-	-	-	5.5	31.5
		BTU/h	95500	95500	95500	-	-	-	18800	107500
	Current	A	0.35 ×4	0.34 ×4	0.33 ×4	11.5	10.9	10.5	-	-
		W	36 ×4	36 ×4	36 ×4	7.056k	7.056k	7.056k	-	-
	Input power	TOTAL W	-			7.200k	7.200k	7.200k	1.000k	10.100k
		COP/COP CLASS	TOTAL (W/W) ⁵¹ / (°A~°G)	-	-	-	3.89	3.89 /A	3.89	5.50
	Erp ₆₀	Pdesign at -10°C	kW	-	-	-	-	20.0	-	-
		Tbivalent	°C	-	-	-	-	-10	-	-
	Annual consumption	(W/W)	-	-	-	-	-	174.1	-	-
		kWh	-	-	-	-	-	-	-	-
	elbu(-10°C)	kW	-	-	-	-	-	0.00	-	-
		Class	-	-	-	-	-	-	-	-
	Power factor	%	-	-	-	93	93	93	-	-
	Noise indoor *7	dB-A (H/M/L)	36/31/28			-			-	-
Power Level dB		51/46/43			-			-	-	
Noise outdoor	dB-A (H/L)	-			63/-			-	-	
	Power Level dB	-			82/-			-	-	
EXTRA LOW TEMP Total capacity(kW)/input power(W)/COP		-								
Max Current(A) / Max Input power(W)		0.36/38 ×4	0.35/38 ×4	0.34/38 ×4	18.5/11.3k	18.5/11.9k	18.5/12.4k	-		
Starting current(A) (Cooling/Heating)		-	-	-	12.9/11.5	12.2/10.9	11.8/10.5	-		
Comp output(W)		-			5.50k	5.50k	5.50k	-		
Time Delay fuse max size(A)		5			30			-		
Network Impedance(ΩMAX.)		-			-			-		
Fan motor output (Indoor/Outdoor) W		60			120 × 2			-		
Moisture removal volume		L/h(Pt/h)			6.8 (1.7 ×4) (14.3)			-		
External static pressure		Pa			-			-		
Indoor Air flow *7	Cooling	m ³ /min (m ³ /h) (H/M/L)	21.0×4/16.0×4/13.0×4 (1260)×4/(960)×4/(780)×4			-			-	-
	Heating	m ³ /min (m ³ /h) (H/M/L)	21.0×4/16.0×4/13.0×4 (1260)×4/(960)×4/(780)×4			-			-	-
Outdoor Air flow	Cooling	m ³ /min (m ³ /h)	-			160.0 (9600)			-	-
	Heating	m ³ /min (m ³ /h)	-			160.0 (9600)			-	-
Refrigerant type / amount g(oz)		-			R32 5.20k (183.4)			-		
Product dimension	Height	mm(inch)	256	(10-5/64)		1500	(59-1/16)		-	
	Width	mm(inch)	840	(33-5/64)		980	(38-37/64)		-	
	Depth	mm(inch)	840	(33-5/64)		370	(14-9/16)		-	
Product dimension (Panel)		H×W×D mm, inch	33.5×950×950		(11-1/32×37-13/32×37-13/32)		-			
Packing dimension	Height	mm(inch)	302	(11-57/64)		1642	(64-41/64)		-	
	Width	mm(inch)	898	(35-3/8)		1095	(43-7/64)		-	
	Depth	mm(inch)	898	(35-3/8)		529	(20-53/64)		-	
Weight	(NET)	kg(lb)	20	(44)		128	(282)		-	
	(GROSS)	kg(lb)	27	(60)		140	(309)		-	
	Panel (NET)	kg(lb)	5	(11)		-	-		-	
Layers limit (actually)		11 (12)			1 (2)			-		
Operation condition	Cool (DBT)	18°C ~ 32°C			-15°C ~ 46°C			-		
	Heat (DBT)	16°C ~ 30°C			-20°C ~ 24°C			-		
Max Working Pressure HP/LP Mpa (bar)		4.15/2.70 (41.5/27.0)								
P I P I N G	Pipe diameter mm (inch)	(Liquid)Ø9.52(3/8) (Gas)Ø15.88(5/8)			(Liquid)Ø12.7(1/2) (Gas)Ø25.4(1)			-		
	Connecting method	flared type			(Liquid)flared type (Gas)brazing connection			-		
	Standard length m(ft)	-			7.5 (24.6)			-		
	Pipe length range m (ft)	-			5 ~ 60 m (16.4 ~ 196.9)			-		
	Indoor unit & Outdoor unit height difference m (ft)	-			30 m(OD located lower) / 30 m(OD located higher) (98.4 / 98.4)			-		
Add gas amount g/m (oz/ft)		-			80 g/m (0.860)			-		
Pipe length for additional gas m (ft)		-			30m (98.4)			-		

*1 In case it is necessary to indicate the air flow volume in (l/s), the value in (m³/min.) shall be multiplied by 16.7 and rounded down the decimal point.

*2 If the EUROVENT Certified models can be operated under the "extra-low" temperature condition, -7°C dry bulb and -8°C wet-bulb temperatures with rated voltage 230V shall be used.

*3 Network Impedance shall be applicable for EUROPE and CHINA models.

*4 The annual consumption is calculated by multiplying the input power at 230V(400V) by an average of 500 hours per year in cooling mode.

*5 EER and COP classification is at 230V(400V) only in accordance with EU directive 2002/31/EC.

*6 η_{s,c} and η_{s,h} classification is at 230V(400V) only in accordance with EN-14825. For heating, η_{s,h} indicates the value of only Average heating season.

*7 H:High at setting 5 stage (Level 5), M:Middle at setting 5 stage (Level 3), L:Low at setting 5 stage (Level 1)

1-2. Major Component Specifications

(A) Indoor Units

High Static Pressure Ducted Type S-200PE3E5B

MODEL No.		S-200PE3E5B	
Source		220 - 230 - 240V, single-phase, 50Hz	
Controller P.C.B. Ass'y		ACXA73C51510	
Fan (Number...diameter)	mm	SIROCCO (2...ø250)	
Fan motor			
Model...Nominal output	W	DMUB6D3AC...560W DMUB6D4AC...560W	
Power source		100 - 391 VDC	
No. of pole...r.p.m. (230V, High)	rpm	8P...1080	
Coil resistance (Ambient temperature 20°C)	Ω	-	
Run capacitor	VAC, μF	-	
Electronic expansion valve			
Coil		-	
Coil resistance (at 20°C)	Ω	-	
Valve body		-	
Heat exchanger			
Coil		Aluminium plate fin / Copper tube	
Rows...fin pitch	mm	3...1.8	
Face area	m ²	0.642	

(A) Indoor Units**High Static Pressure Ducted Type S-250PE3E5B**

MODEL No.		S-250PE3E5B
Source		220 - 230 - 240V, single-phase, 50Hz
Controller P.C.B. Ass'y		ACXA73C51510
Fan (Number...diameter)	mm	SIROCCO (2...ø250)
Fan motor		
Model...Nominal output	W	DMUB8D4AC...750W DMUB8D5AC...750W
Power source		100 - 391 VDC
No. of pole...r.p.m. (230V, High)	rpm	8P...1180
Coil resistance (Ambient temperature 20°C)	Ω	—
Run capacitor	VAC, μF	—
Electronic expansion valve		
Coil		—
Coil resistance (at 20°C)	Ω	—
Valve body		—
Heat exchanger		
Coil		Aluminium plate fin / Copper tube
Rows...fin pitch	mm	3...1.8
Face area	m ²	0.642

(A) Indoor Units

4-Way Cassette Type S-50PU2E5B

MODEL No.		S-50PU2E5B
Source		220 - 230 - 240 V, single-phase, 50 Hz
Controller P.C.B. Ass'y		ACXA73-2553*(Microprocessor)
Fan (Number...diameter)	mm	Turbo (1...ø485)
Fan motor		
Model...Nominal output	W	SIC-62FW-D839-1...60W
Power source		280 VDC
No. of pole...r.p.m. (230V, High)	rpm	8P...360
Run capacitor	VAC, μ F	-
Safety device		overcurrent, rotating signal detection, fuse
Heat exchanger		
Coil		Aluminium plate fin / Copper tube
Rows...fin pitch	mm	2...1.21
Face area	m^2	0.359
Panel		
Model No.		CZ-KPU3
Auto louver motor		MSBPC20A20
Coil resistance	Ω	300 Ω \pm 7% / phase
Drain pump		
Model No.		PMD-12D13ST-8
Rated	V, W	DC 13 V, 4.2 W
Drain piping rise height from unit bottom, capacity		850 mm, 400 cc/min

(A) Indoor Units

4-Way Cassette Type S-60PU2E5B

MODEL No.		S-60PU2E5B
Source		220 - 230 - 240 V, single-phase, 50 Hz
Controller P.C.B. Ass'y		ACXA73-2553*(Microprocessor)
Fan (Number...diameter)	mm	Turbo (1...ø485)
Fan motor		
Model...Nominal output	W	SIC-62FW-D839-1...60W
Power source		280 VDC
No. of pole...r.p.m. (230V, High)	rpm	8P...420
Run capacitor		VAC, μ F
Safety device		overcurrent, rotating signal detection, fuse
Heat exchanger		
Coil		Aluminium plate fin / Copper tube
Rows...fin pitch	mm	2...1.21
Face area		m^2
Panel		
Model No.		CZ-KPU3
Auto louver motor		MSBPC20A20
Coil resistance	Ω	300 Ω \pm 7% / phase
Drain pump		
Model No.		PMD-12D13ST-8
Rated	V, W	DC 13 V, 4.2 W
Drain piping rise height from unit bottom, capacity		850 mm, 400 cc/min

(A) Indoor Units

4-Way Cassette Type S-71PU2E5B

MODEL No.		S-71PU2E5B
Source		220 - 230 - 240 V, single-phase, 50 Hz
Controller P.C.B. Ass'y		ACXA73-2553*(Microprocessor)
Fan (Number...diameter)	mm	Turbo (1...ø485)
Fan motor		
Model...Nominal output	W	SIC-62FW-D839-1...60W
Power source		280 VDC
No. of pole...r.p.m. (230V, High)	rpm	8P...440
Run capacitor		VAC, μ F
Safety device		overcurrent, rotating signal detection, fuse
Heat exchanger		
Coil		Aluminium plate fin / Copper tube
Rows...fin pitch	mm	2...1.21
Face area		m^2
Panel		
Model No.		CZ-KPU3
Auto louver motor		MSBPC20A20
Coil resistance	Ω	300 Ω \pm 7% / phase
Drain pump		
Model No.		PMD-12D13ST-8
Rated	V, W	DC 13 V, 4.2 W
Drain piping rise height from unit bottom, capacity		850 mm, 400 cc/min

(A) Indoor Units

4-Way Cassette Type S-100PU2E5B

MODEL No.		S-100PU2E5B	
Source		220 - 230 - 240 V, single-phase, 50 Hz	
Controller P.C.B. Ass'y		ACXA73-2553*(Microprocessor)	
Fan (Number...diameter)	mm	Turbo (1...ø485)	
Fan motor			
Model...Nominal output	W	SIC-72FW-D895-1...90W	
Power source		280 VDC	
No. of pole...r.p.m. (230V, High)	rpm	8P...600	
Run capacitor	VAC, µF	-	
Safety device		overcurrent, rotating signal detection, fuse	
Heat exchanger			
Coil		Aluminium plate fin / Copper tube	
Rows...fin pitch	mm	3...1.15	
Face area	m ²	0.560	
Panel			
Model No.		CZ-KPU3	
Auto louver motor		MSBPC20A20	
Coil resistance	Ω	300 Ω ± 7% / phase	
Drain pump			
Model No.		PMD-12D13ST-8	
Rated	V, W	DC 13 V, 4.2 W	
Drain piping rise height from unit bottom, capacity		850 mm, 400 cc/min	

(A) Indoor Units**4-Way Cassette Type S-125PU2E5B**

MODEL No.		S-125PU2E5B	
Source		220 - 230 - 240 V, single-phase, 50 Hz	
Controller P.C.B. Ass'y		ACXA73-2553*(Microprocessor)	
Fan (Number...diameter)	mm	Turbo (1...ø485)	
Fan motor			
Model...Nominal output	W	SIC-72FW-D895-1...90W	
Power source		280 VDC	
No. of pole...r.p.m. (230V, High)	rpm	8P...620	
Run capacitor	VAC, μ F	-	
Safety device		overcurrent, rotating signal detection, fuse	
Heat exchanger			
Coil		Aluminium plate fin / Copper tube	
Rows...fin pitch	mm	3...1.15	
Face area	m ²	0.560	
Panel			
Model No.		CZ-KPU3	
Auto louver motor		MSBPC20A20	
Coil resistance	Ω	300 Ω \pm 7% / phase	
Drain pump			
Model No.		PMD-12D13ST-8	
Rated	V, W	DC 13 V, 4.2 W	
Drain piping rise height from unit bottom, capacity		850 mm, 400 cc/min	

(B) Outdoor Units**U-200PZH2E8**

MODEL No.		U-200PZH2E8	
Source		380 - 400 - 415V 3-Phase 50Hz	
Controller P.C.B. Ass'y		ACXA73C49270	
Control circuit fuse		30A	
Compressor			
Model....number		9VD550XAA21	
Source		460V DC MOTOR	
Nominal output	W	4,200	
Compressor oil	cc	1,900	
Coil resistance (Ambient temperature 25°C)	Ω	U-V 0.735	U-W 0.715 V-W 0.715
Safety control		Discharge temperature control	
Overload relay models		-	
Operation temperature	Open °C	-	
	Close °C	-	
Crank case heater	W	230V-32W	
Refrigerant amount at shipment		kg	
		R32-4.2	
High pressure switch			
Set pressure	OFF	MPa	4.15 ⁺⁰ _{-0.2}
	ON	MPa	3.05±0.2
Fan			
Number...diameter	mm	2...ø540	
Air circulation	m ³ / h	164	
Fan speeds (Max.)			
Fan motor			
Model No.		NFD-81FW-D8120-6, NFD-81FW-D8120-7	
Source		DC 280V	
No. of pole		8	
Nominal output	W	120	
Safety device		-	
Operating temperature	Open °C	-	
	Close °C	-	
Run capacitor	VAC, μF	-	
Heat exchanger			
Coil		Aluminium plate fin / Copper tube	
Rows...fin pitch	mm	2..18FPI	
Face area	m ²	1.367	

(B) Outdoor Units**U-250PZH2E8**

MODEL No.		U-250PZH2E8	
Source		380 - 400 - 415V 3-Phase 50Hz	
Controller P.C.B. Ass'y		ACXA73C49250	
Control circuit fuse		30A	
Compressor			
Model....number		9VD550XAA21	
Source		460V DC MOTOR	
Nominal output	W	5,500	
Compressor oil	cc	1,900	
Coil resistance (Ambient temperature 25°C)	Ω	U-V 0.735 U-W 0.715 V-W 0.715	
Safety control		Discharge temperature control	
Overload relay models		-	
Operation temperature	Open °C	-	
	Close °C	-	
Crank case heater	W	230V-32W	
Refrigerant amount at shipment		kg	R32-5.2
High pressure switch			
Set pressure	OFF	MPa	4.15 ⁺⁰ _{-0.2}
	ON	MPa	3.05±0.2
Fan			
Number...diameter	mm	2...ø540	
Air circulation	m ³ / h	160	
Fan speeds (Max.)			
Fan motor			
Model No.		NFD-81FW-D8120-6, NFD-81FW-D8120-7	
Source		DC 280V	
No. of pole		8	
Nominal output	W	120	
Safety device		-	
Operating temperature	Open °C	-	
	Close °C	-	
Run capacitor	VAC, μF	-	
Heat exchanger			
Coil		Aluminium plate fin / Copper tube	
Rows...fin pitch	mm	3..17FPI	
Face area	m ²	1.367	

1-3. Other Component Specifications

Outdoor Units U-200PZH2E8

MODEL No.	Outdoor Unit	U-200PZH2E8
Power Transformer		
Rated		–
Source	VAC, Hz	–
Secondary		–
Coil resistance	Ω	–
Thermal cut off temperature		–
Thermistor (Coil / Air sensor): TH1, TH2, TH3, TH4		
Resistance	k Ω	-20°C : 38.48±2% 20°C : 6.517±2%
		-10°C : 23.67±2% 30°C : 4.448±2%
		0°C : 15.00±2% 40°C : 3.100±2%
		5°C : 12.06±2% 45°C : 2.607±2%
		10°C : 9.765±2% 50°C : 2.203±2%
Thermistor (Discharge gas sensor): TH5		
Resistance	k Ω	60°C : 13.85±2% 85°C : 5.946±2%
		65°C : 11.59±2% 90°C : 5.086±2%
		70°C : 9.743±2% 95°C : 4.367±2%
		75°C : 8.228±2% 100°C : 3.764±2%
		80°C : 6.981±2% 105°C : 3.256±2%
Relay (Comp. Magnetic Contactor)		
Coil rated	VAC	–
Contact rating	VAC, A	–
Coil resistance (at 20°C)	Ω	–
Sol-Control-Valve		
Sol-control-valve		UKV32D322
Magnetic coil		UKV-A392
4 way valve		
4 way valve		SHF-20B-46-DC
Electro magnetic coil		SQ-D23015-002283 DC15.4V(898mA)

Outdoor Units U-250PZH2E8

MODEL No.	Outdoor Unit	U-250PZH2E8	
Power Transformer			
Rated		-	
Source	VAC, Hz	-	
Secondary		-	
Coil resistance	Ω	-	
Thermal cut off temperature		-	
Thermistor (Coil / Air sensor): TH1, TH2, TH3, TH4			
Resistance	k Ω	-20°C : 38.48±2%	20°C : 6.517±2%
		-10°C : 23.67±2%	30°C : 4.448±2%
		0°C : 15.00±2%	40°C : 3.100±2%
		5°C : 12.06±2%	45°C : 2.607±2%
		10°C : 9.765±2%	50°C : 2.203±2%
Thermistor (Discharge gas sensor): TH5			
Resistance	k Ω	60°C : 13.85±2%	85°C : 5.946±2%
		65°C : 11.59±2%	90°C : 5.086±2%
		70°C : 9.743±2%	95°C : 4.367±2%
		75°C : 8.228±2%	100°C : 3.764±2%
		80°C : 6.981±2%	105°C : 3.256±2%
Relay (Comp. Magnetic Contactor)			
Coil rated	VAC	-	
Contact rating	VAC, A	-	
Coil resistance (at 20°C)	Ω	-	
Sol-Control-Valve			
Sol-control-valve		UKV32D322	
Magnetic coil		UKV-A392	
4 way valve			
4 way valve		SHF-35B-67-03	
Electro magnetic coil		SQ-A2522G-005129 AC220-240V 50-60Hz	

1-4. Dimensional Data

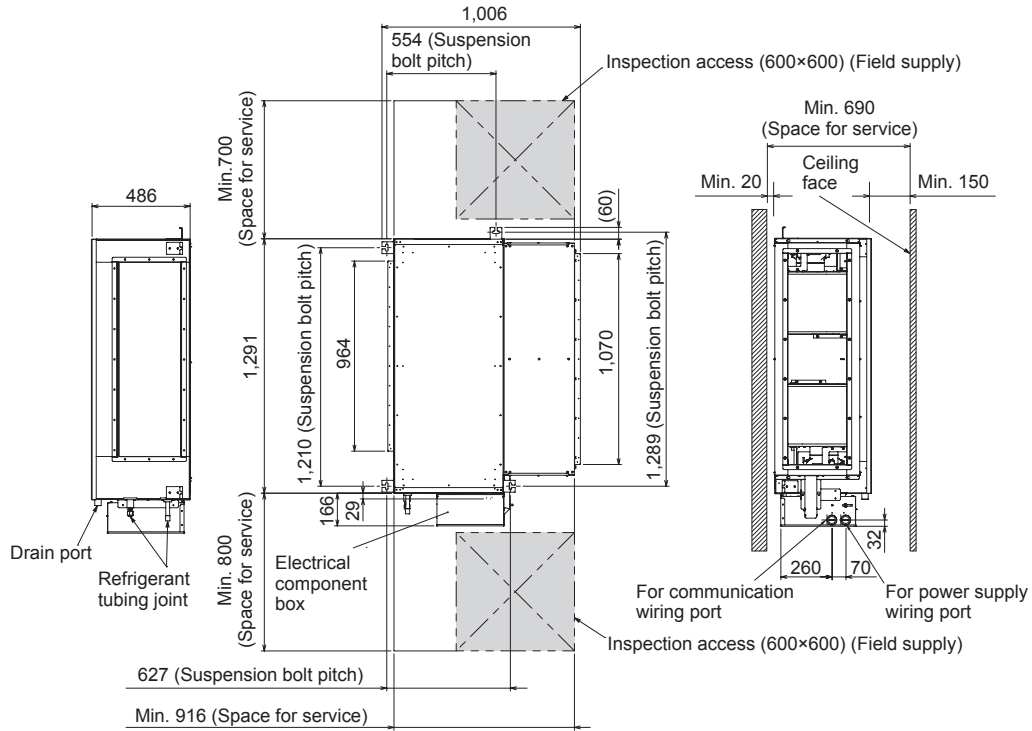
(A) Indoor Units: High Static Pressure Ducted Type

S-200PE3E5B / S-250PE3E5B

Required Minimum Space for Installation and Service

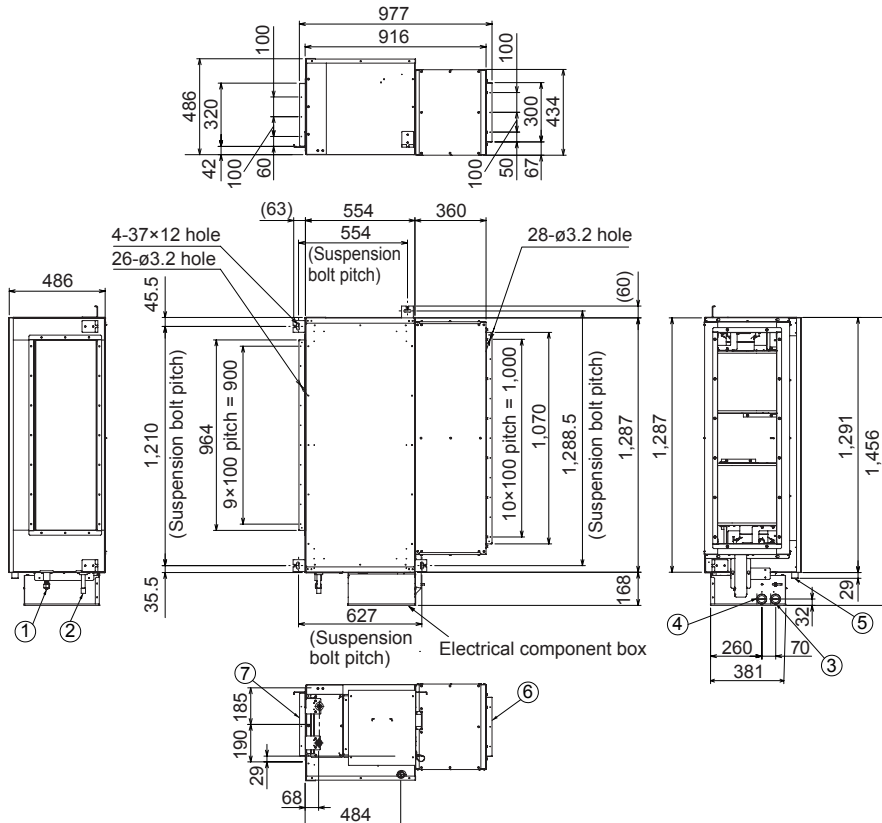
(1) Dimensions of suspension bolt pitch and unit

Unit: mm



(2) Dimensions of indoor unit

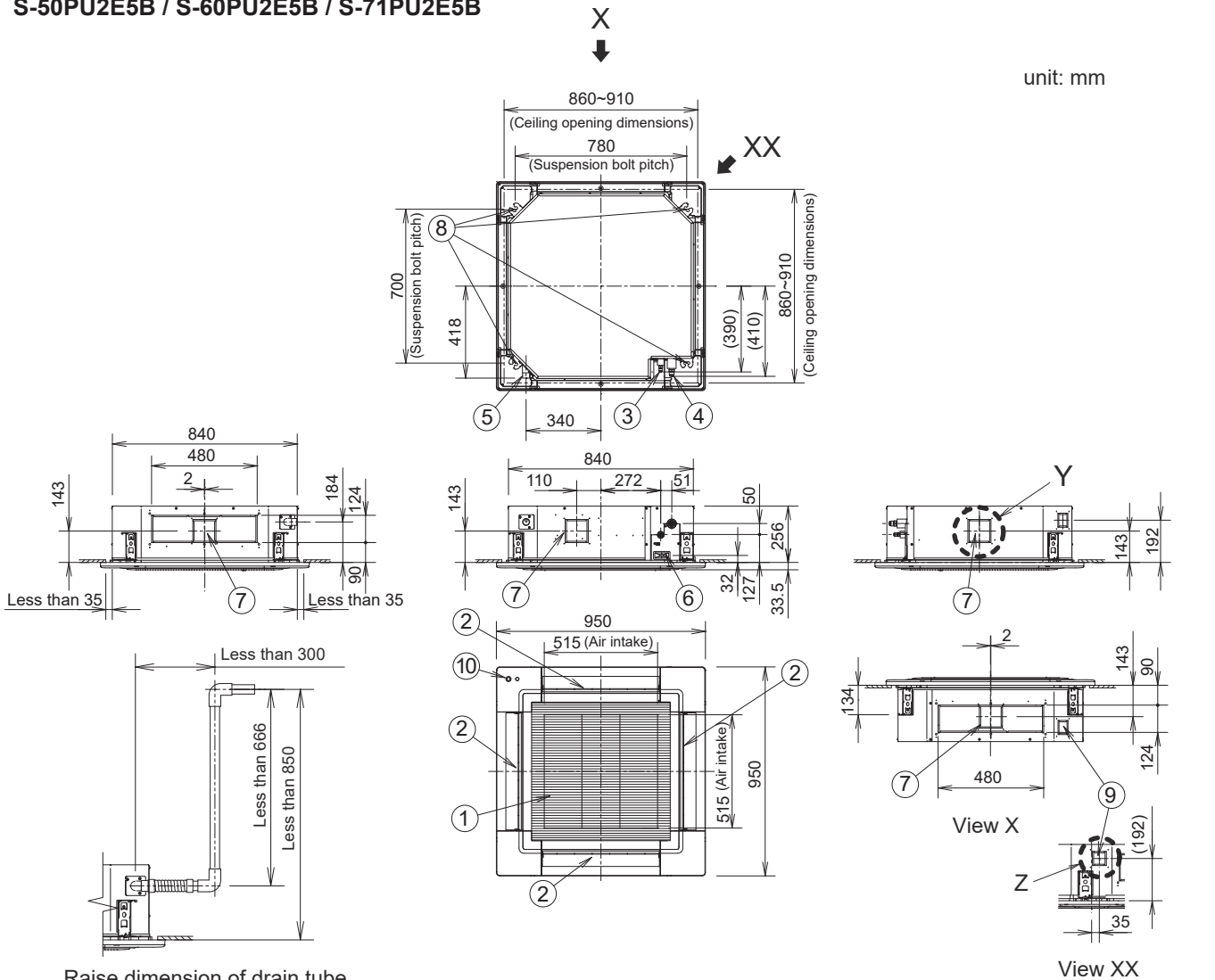
Unit: mm



①	Refrigerant liquid tubing (Flare) ∅12.7 (Type 200 : Connection Tubing ∅12.7 → ∅9.52)
②	Refrigerant gas tubing (Brazing) ∅19.05 (Connection Tubing ∅19.05 → ∅25.4)
③	Power supply port
④	Communication port
⑤	Drain port VP25
⑥	Air intake duct connecting side flange
⑦	Air discharge duct connecting side flange

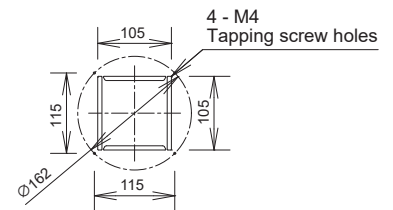
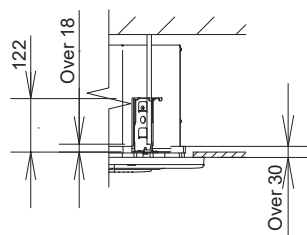
(A) Indoor Units: 4-Way Cassette Type
S-50PU2E5B / S-60PU2E5B / S-71PU2E5B

unit: mm

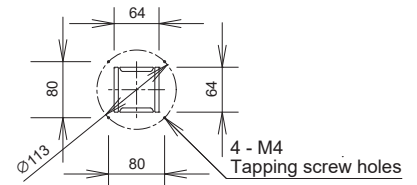


Raise dimension of drain tube

The length of the suspension bolts should be selected so that there is a gap of 30 mm or more below the lower surface of the ceiling (18 mm or more below the lower surface of the main unit), as shown in the figure at right. If the suspension bolt is too long, it will contact the ceiling panel and the unit cannot be installed.



Detailed view Y



Detailed view Z

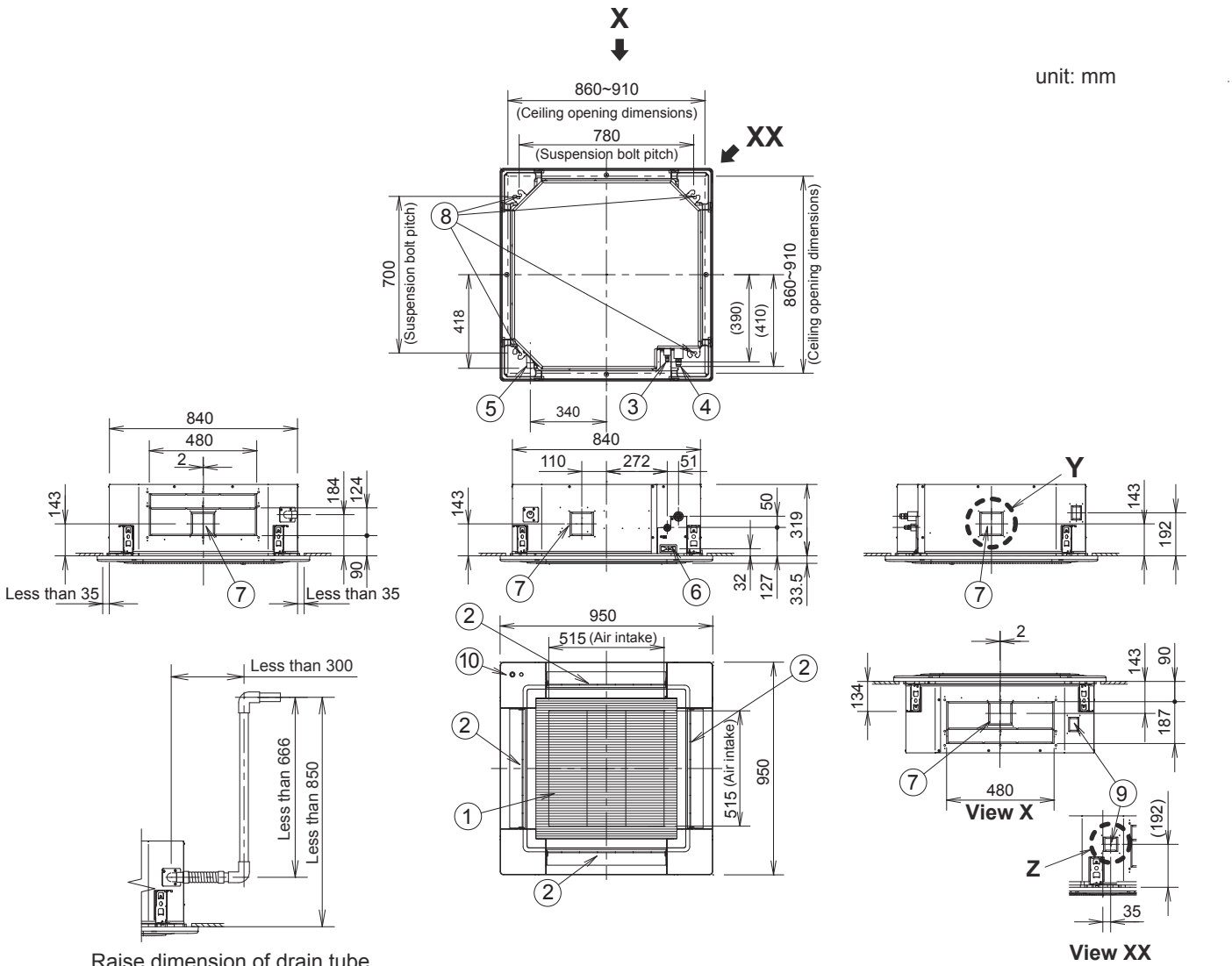
①	Air intake
②	Discharge outlet
③	Refrigerant tubing (liquid tube) 36-50 type ø6.35 (flared), 60 • 71 type ø9.52 (flared)
④	Refrigerant tubing (gas tube) 36-50 type ø12.7 (flared), 60 • 71 type ø15.88 (flared)
⑤	Drain tube connection port VP25 (outer dia. ø32)
⑥	Power supply port
⑦	Discharge duct connection port (ø150)
⑧	Suspension bolt hole (4-12×30 elongated hole)
⑨	Fresh air intake duct connection port (ø100) *
⑩	ECONAVI sensor (Only CZ-KPU3A)

* Necessary to attach duct connecting flange(field supplied).

<Filter dimension>

520 x 520 x 15

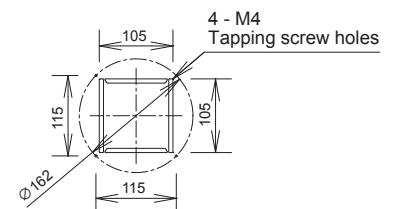
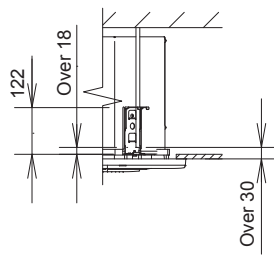
S-100PU2E5B / S-125PU2E5B



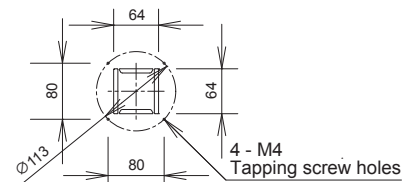
unit: mm

Raise dimension of drain tube

The length of the suspension bolts should be selected so that there is a gap of 30 mm or more below the lower surface of the ceiling (18 mm or more below the lower surface of the main unit), as shown in the figure at right. If the suspension bolt is too long, it will contact the ceiling panel and the unit cannot be installed.



Detailed view Y



Detailed view Z

①	Air intake
②	Discharge outlet
③	Refrigerant tubing (liquid tube) $\phi 9.52$ (flared)
④	Refrigerant tubing (gas tube) $\phi 15.88$ (flared)
⑤	Drain tube connection port VP25 (outer dia. $\phi 32$)
⑥	Power supply port
⑦	Discharge duct connection port ($\phi 150$)
⑧	Suspension bolt hole (4-12 \times 30 elongated hole)
⑨	Fresh air intake duct connection port ($\phi 100$) *
⑩	ECONAVI sensor (Only CZ-KPU3A)

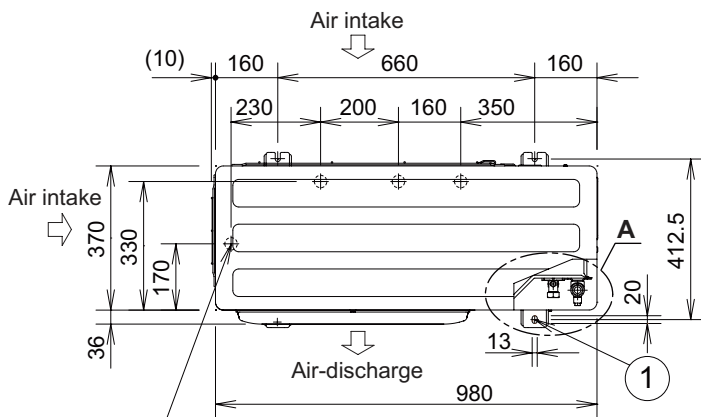
* Necessary to attach duct connecting flange(field supplied).

<Filter dimension>

520 x 520 x 15

(B) Outdoor Unit: U-200PZH2E8

Unit: mm



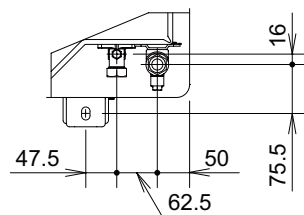
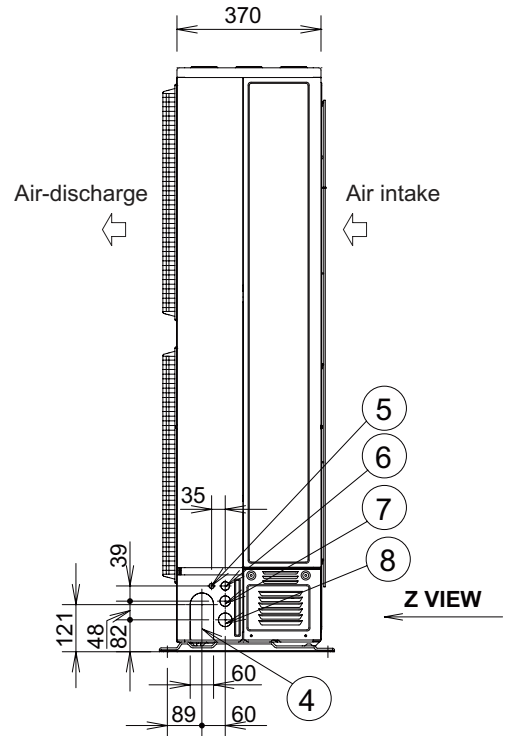
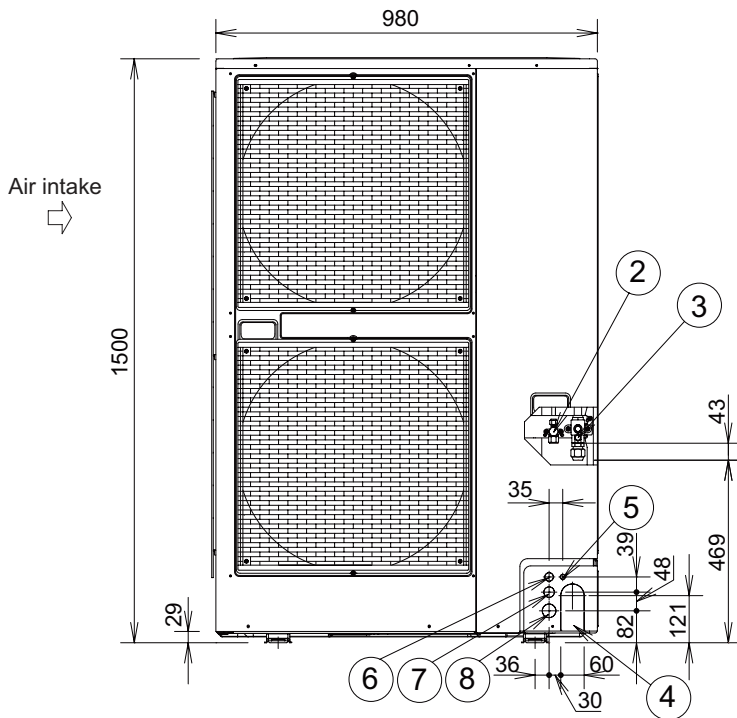
4 × ϕ 32 holes (holes for drain)
 When using a drain pipe, install the drain socket (field supply) onto the drain port. Seal the other drain port with the rubber cap.

- ① Mounting hole (4-R6.5), anchor bolt : M10
- ② Refrigerant tubing (liquid tube), flared connection (ϕ 9.52)
- ③ Refrigerant tubing (gas tube), flared connection (ϕ 19.05) *1
- ④ Refrigerant tubing port
- ⑤ Electrical wiring port (ϕ 13)
- ⑥ Electrical wiring port (ϕ 22)
- ⑦ Electrical wiring port (ϕ 27)
- ⑧ Electrical wiring port (ϕ 35)

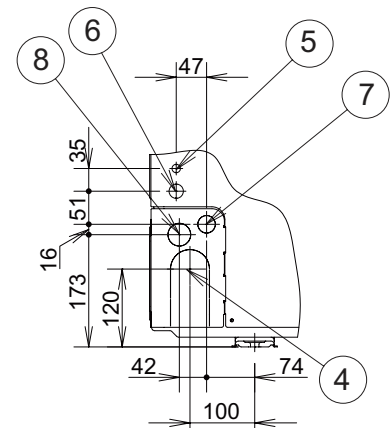
Specification for pipe connecting indoor unit to outdoor unit

		U-200PZH2E8
Valve size (Outdoor unit)	Liquid	ϕ 9.52
	Gas	ϕ 19.05 *1
Main tube (Outdoor unit to Indoor unit)	Liquid	ϕ 9.52
	Gas	ϕ 25.4

*1 (Gas tubing connection) While the main gas tube is ϕ 25.4, since connecting the outdoor unit's 3-way valve requires a ϕ 19.05 flare, please be sure to use standard accessories joint tubing A for connection (brazing).



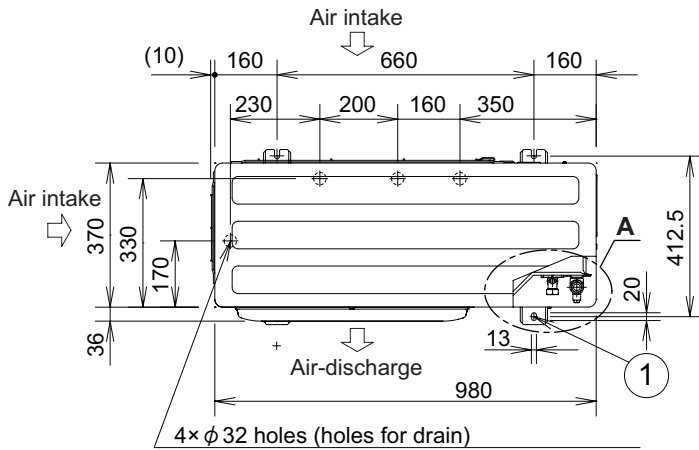
A VIEW



Z VIEW

(B) Outdoor Unit: U-250PZH2E8

Unit: mm



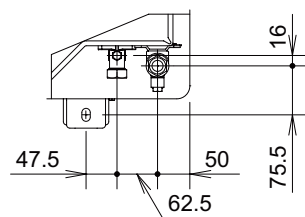
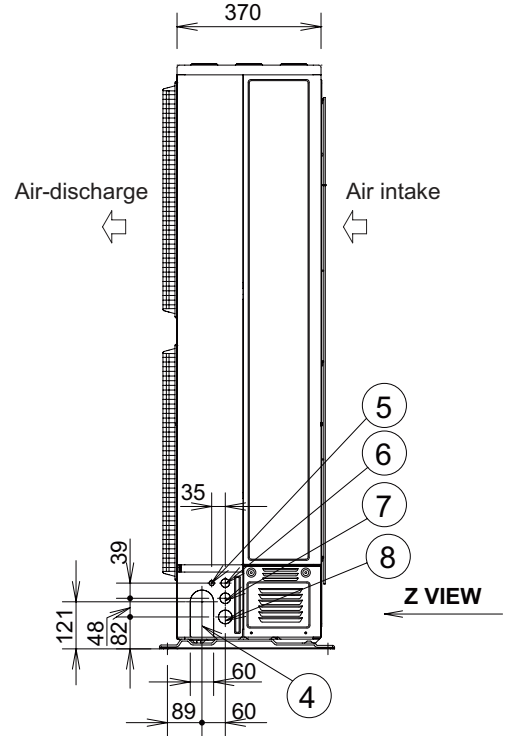
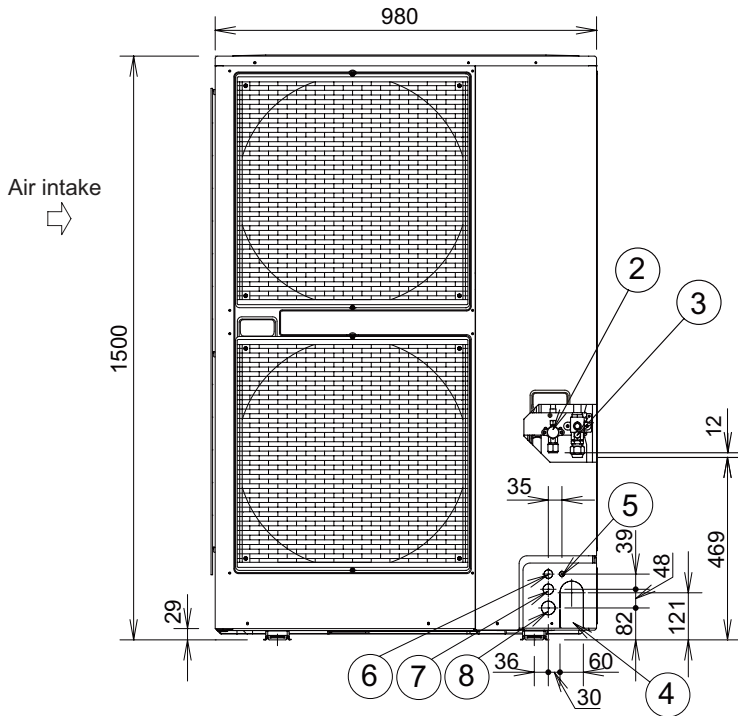
When using a drain pipe, install the drain socket (field supply) onto the drain port. Seal the other drain port with the rubber cap.

①	Mounting hole (4-R6.5), anchor bolt : M10
②	Refrigerant tubing (liquid tube), flared connection (ø12.7)
③	Refrigerant tubing (gas tube), flared connection (ø19.05)*1
④	Refrigerant tubing port
⑤	Electrical wiring port (ø13)
⑥	Electrical wiring port (ø22)
⑦	Electrical wiring port (ø27)
⑧	Electrical wiring port (ø35)

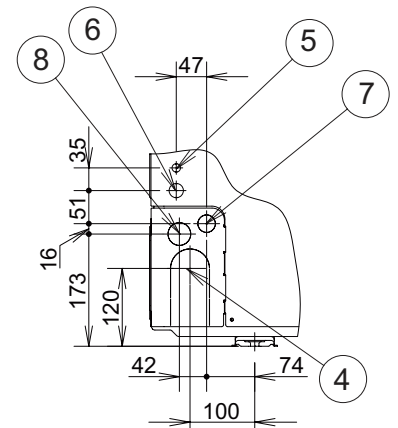
Specification for pipe connecting indoor unit to outdoor unit.

		U-250PZH2E8
Valve size (Outdoor unit)	Liquid	ø12.7
	Gas	ø19.05 *1
Main tube (Outdoor unit to Indoor unit)	Liquid	ø12.7
	Gas	ø25.4

*1 (Gas tubing connection) While the main gas tube is ø25.4, since connecting the outdoor unit's 3-way valve requires a ø19.05 flare, please be sure to use standard accessories joint tubing A for connection (brazing).



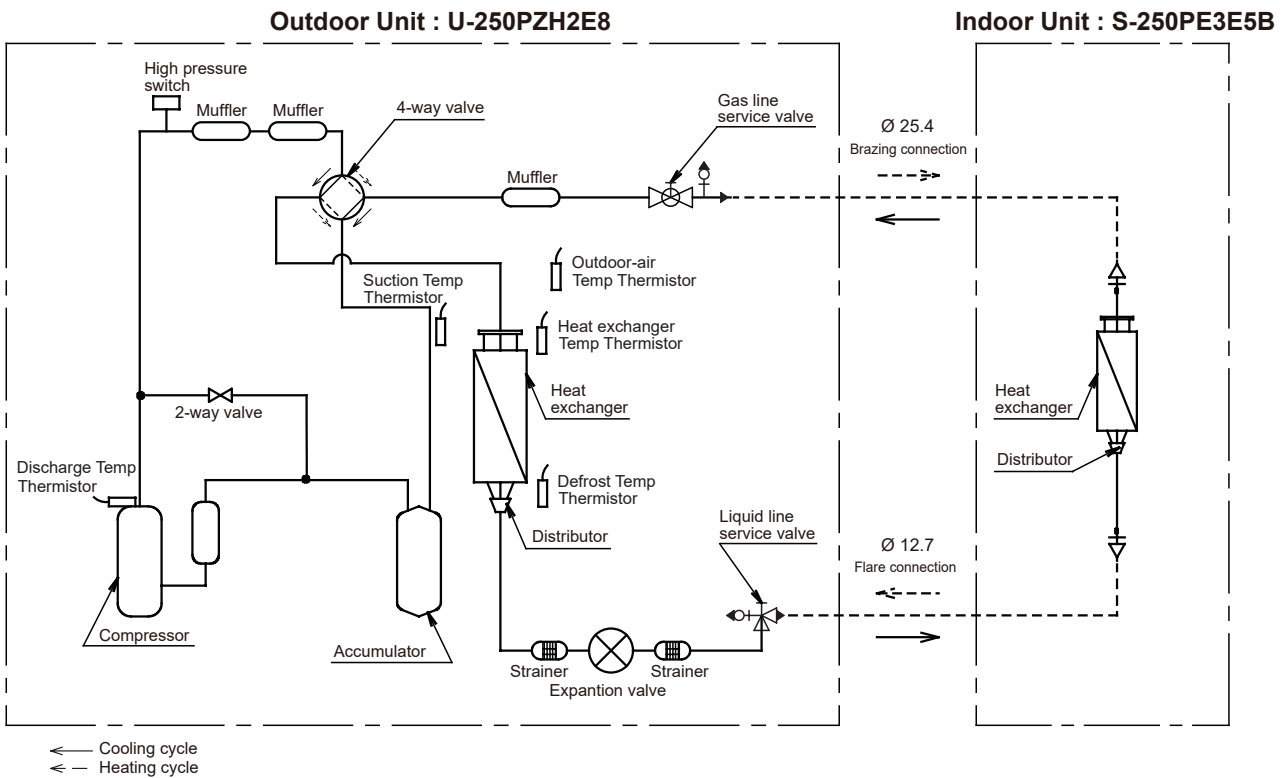
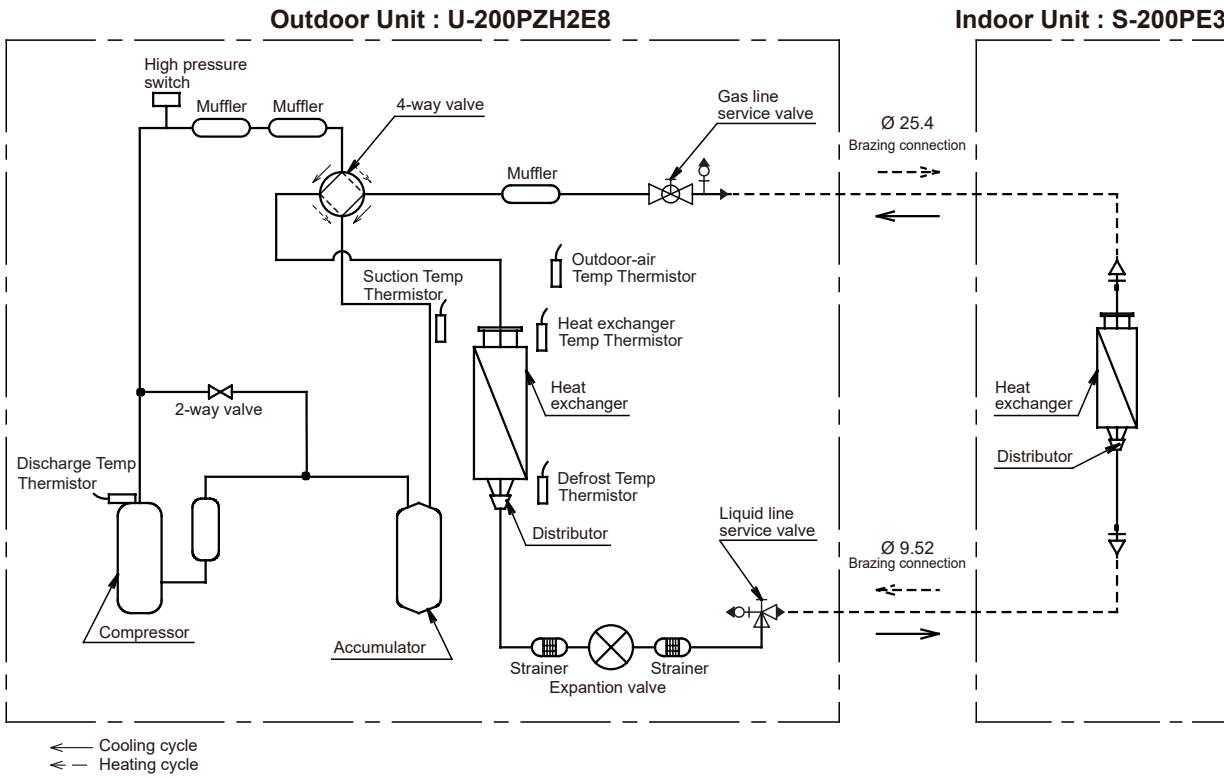
A VIEW



Z VIEW

1-5. Refrigerant Flow Diagram

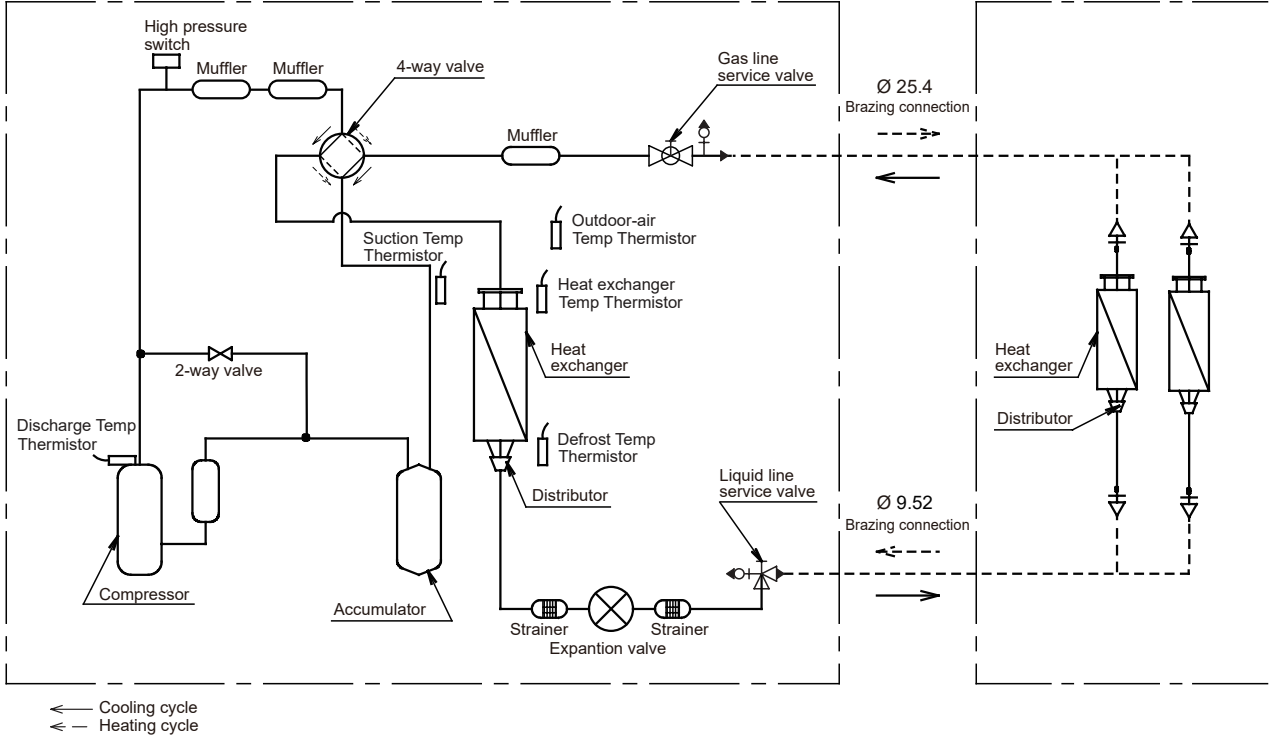
← Cooling cycle
 ← - - Heating cycle



← Cooling cycle
 ← - - Heating cycle

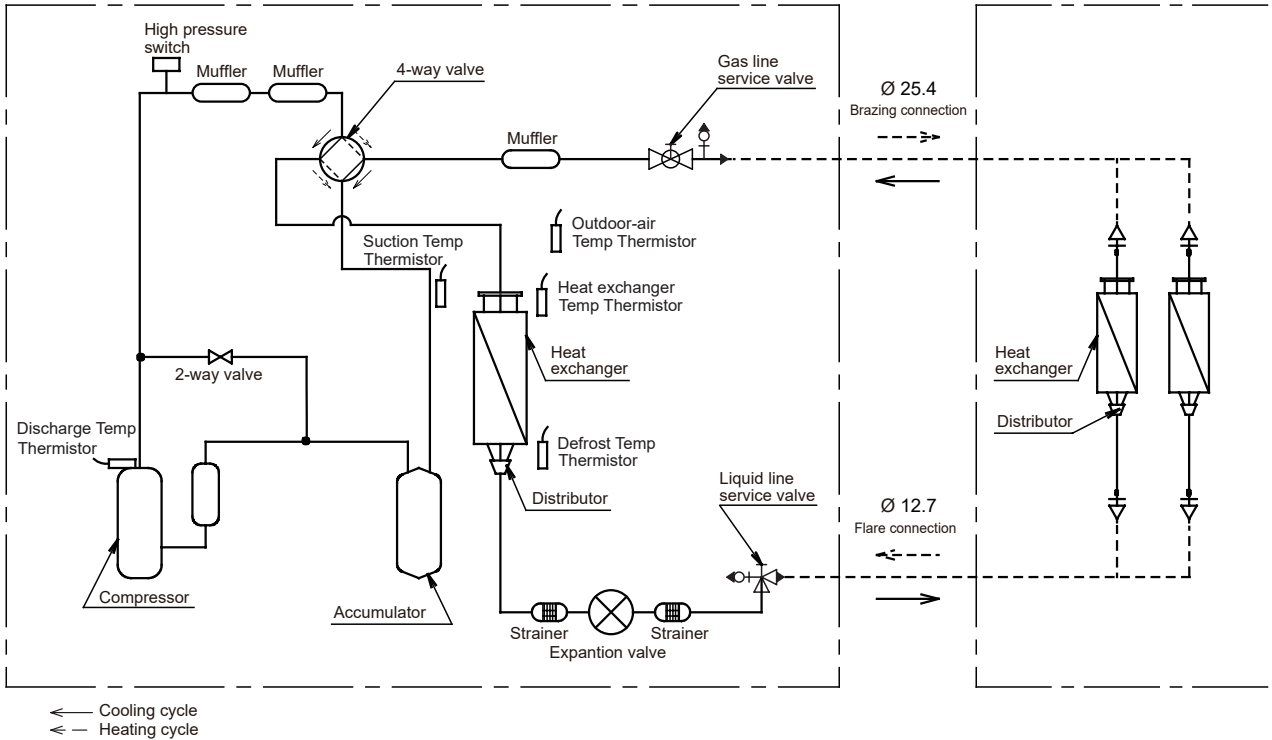
Outdoor Unit : U-200PZH2E8

Indoor Unit : S-100PU2E5B×2



Outdoor Unit : U-250PZH2E8

Indoor Unit : S-125PU2E5B×2



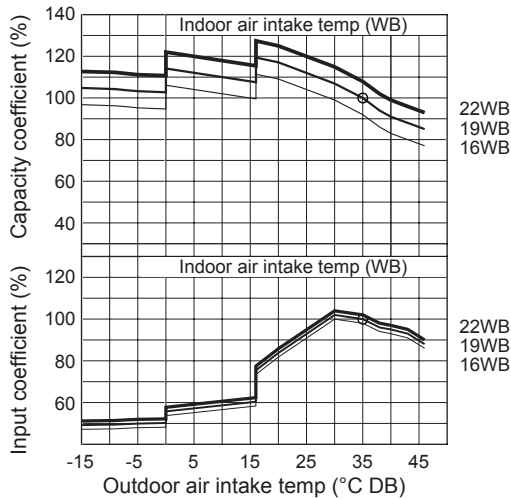
1-6. Operating Range

	Temperature	Indoor air intake temp.	Outdoor air intake temp.
Cooling	Maximum	32°C DB	46°C DB
	Minimum	18°C DB	-15°C DB
Heating	Maximum	30°C DB	24°C DB
	Minimum	16°C DB	-20°C DB

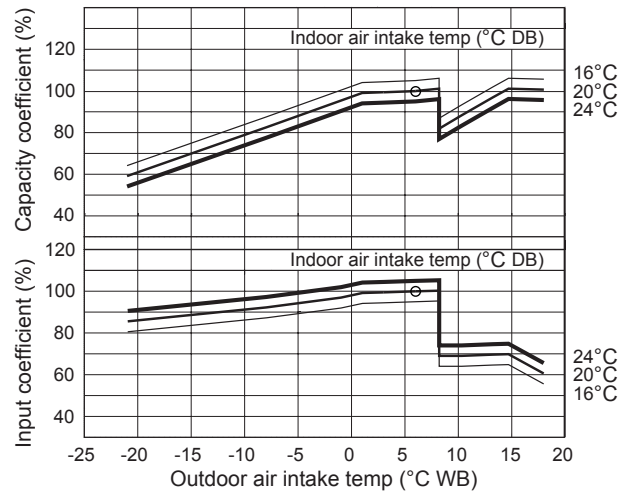
1-7. Capacity Correction Graph According to Temperature Condition

U-200PZH2E8 / U-250PZH2E8 (For 50 Hz)

① Cooling capacity ratio (maximum capacity)



Heating capacity ratio (maximum capacity)



NOTE 1

- The graphs "①" of the characteristics show the value under the following conditions.
 Equivalent tubing length : 7.5m
 Difference of elevation : 0m
 Wind speed : High
- "○" marking indicates the maximum capacity / maximum power consumption.
 Maximum capacity indicates the maximum value in the parentheses of the specifications (cooling and heating capacity).
- The characteristic of heating capacity excludes the decline of capacity when frosting (including defrost drive).

Outdoor unit heating capacity correction coefficient during of frosting/defrosting

Outdoor intake air temperature °C WB	-21	-20	-19	-18	-17	-16	-15	-14	-13	-12	-11	-10	-9	-8	-7	-6	-5	-4	-3
Correction coefficient	0.880	0.880	0.880	0.880	0.880	0.880	0.880	0.880	0.880	0.880	0.880	0.880	0.880	0.880	0.880	0.880	0.860	0.830	0.830

Outdoor intake air temperature °C WB	-2	-1	0	1	2	3	4	5	6
Correction coefficient	0.820	0.820	0.830	0.830	0.850	0.890	0.910	0.950	1.000

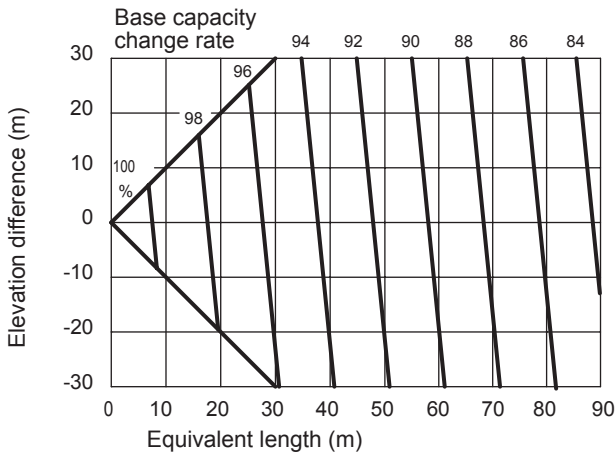
To calculate the heating capacity with consideration for frosting/defrosting operation, multiply the heating capacity found from the capacity graph by the correction coefficient from the table above.

② Graph of capacity change characteristics resulting from tubing length and elevation difference
 (Performance correction coefficients by elevation difference of refrigerant tube length [performance change rate ÷ 100] is calculated by the following line map.)

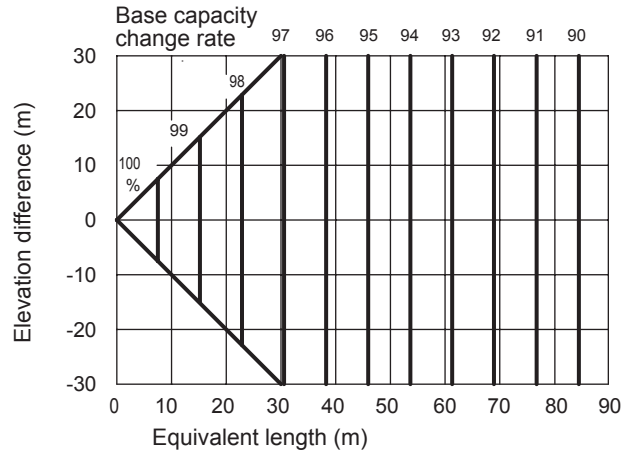
U-200PZH2E8 (For 50 Hz)

Type E3

<Cooling>

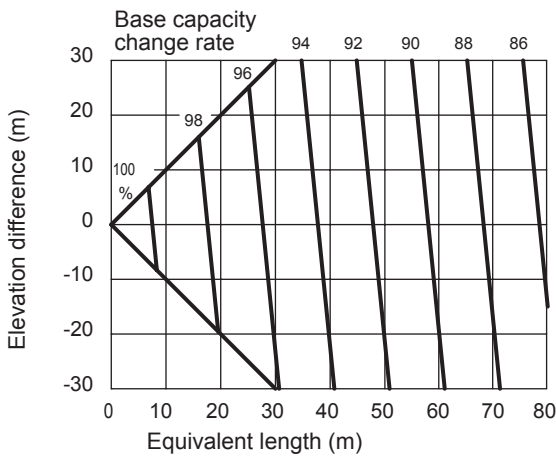


<Heating>

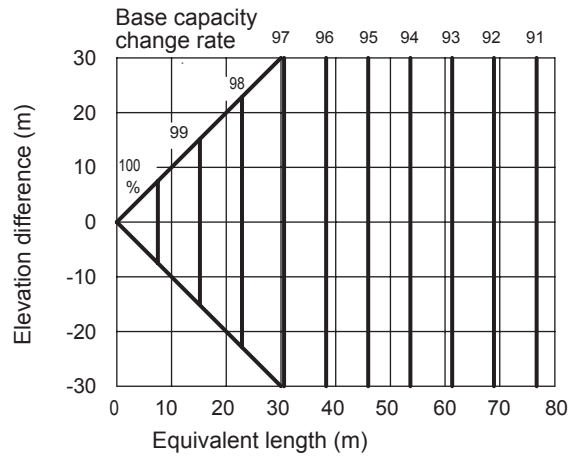


Type U2

<Cooling>



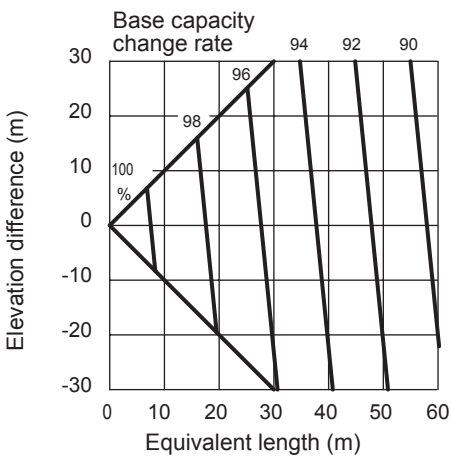
<Heating>



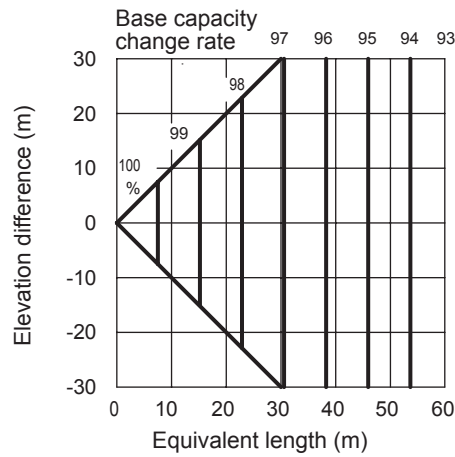
U-250PZH2E8 (For 50 Hz)

Type E3, Type U2

<Cooling>



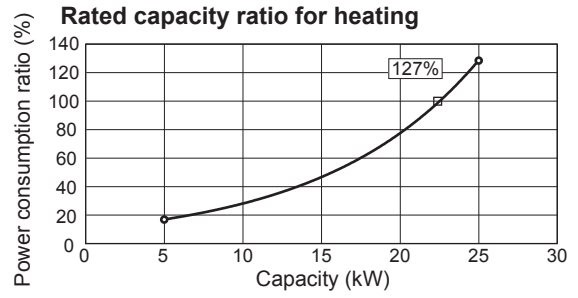
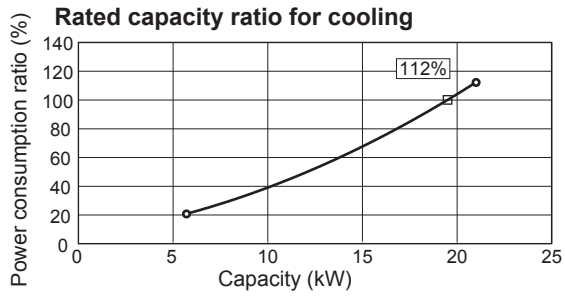
<Heating>



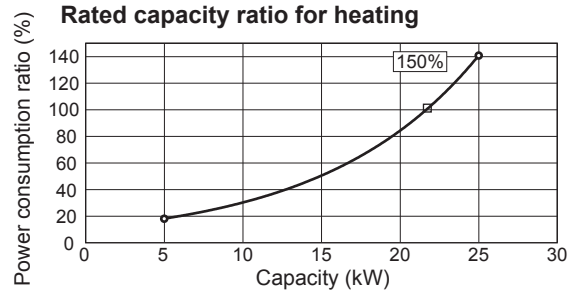
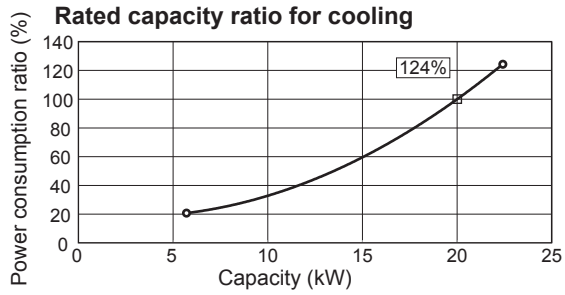
*The positive side for the elevation difference indicates that the outdoor unit is installed at a higher position than the indoor units.
 The negative side indicates the opposite.

③ U-200PZH2E8

Type E3

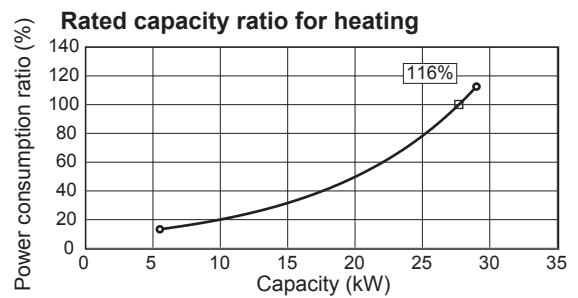
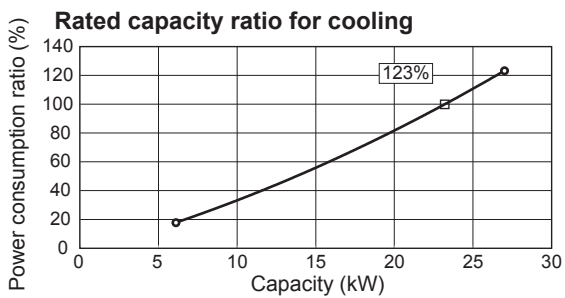


Type U2

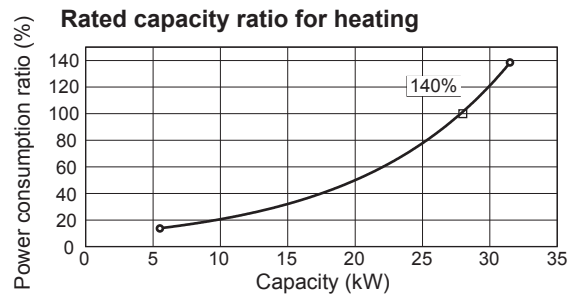
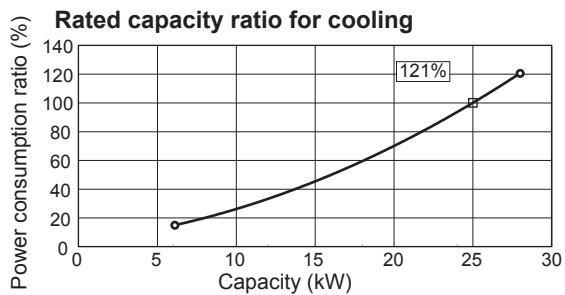


③ U-250PZH2E8

Type E3



Type U2



NOTE 2

- The graphs "③" of the characteristics show the value under the following conditions.
 - Equivalent tubing length : 7.5m
 - Difference of elevation : 0m
 - Wind speed : High

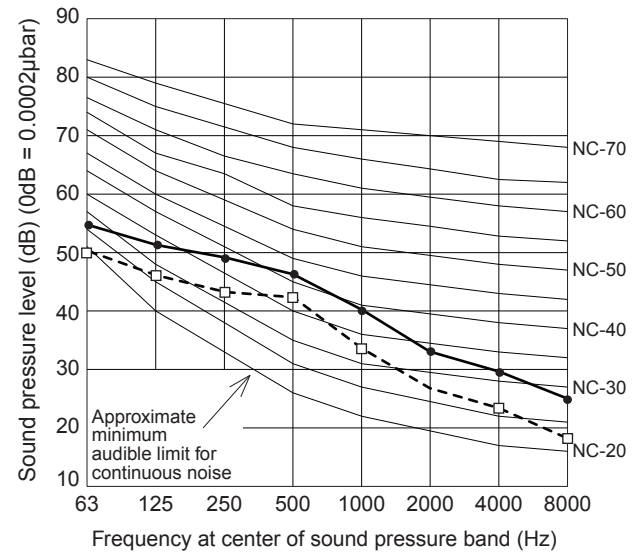
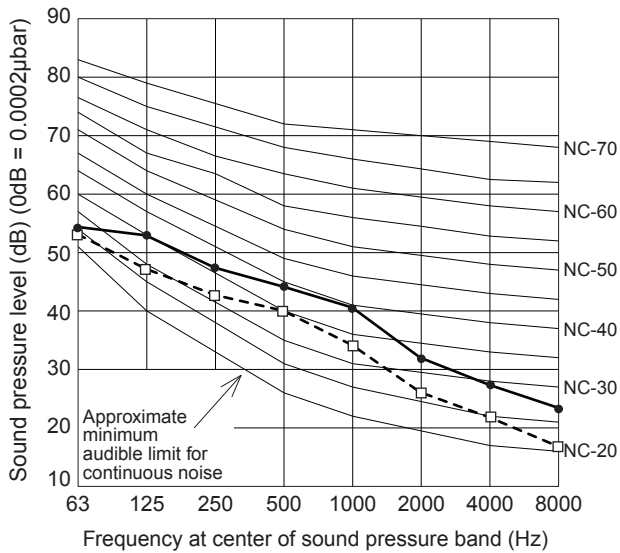
1-8. Noise Criterion Curves

High Static Pressure Ducted Type

—●— High
- -□- - Low

MODEL	: S-200PE3E5B	
SOUND LEVEL	High	46 dB(A)
	Low	41 dB(A)
CONDITION	: Under the unit 1.5 m	

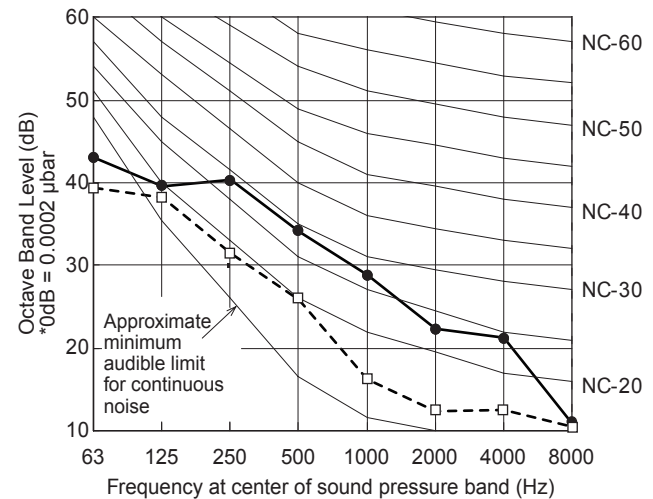
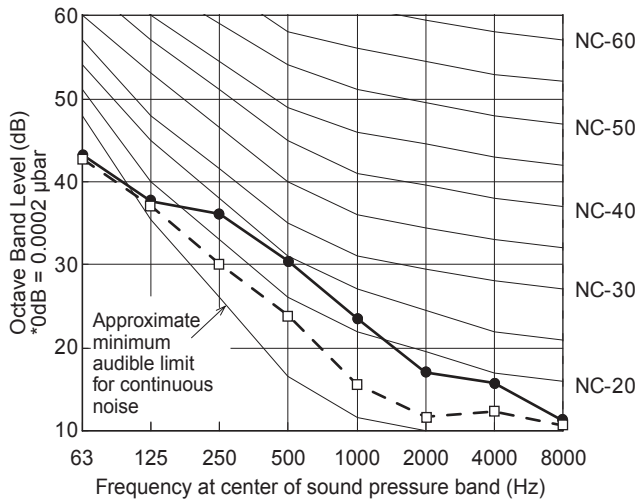
MODEL	: S-250PE3E5B	
SOUND LEVEL	High	47 dB(A)
	Low	42 dB(A)
CONDITION	: Under the unit 1.5 m	



4-Way Cassette Type

MODEL	: S-50PU2E5B	
SOUND LEVEL	High	32 dB(A)
	Low	27 dB(A)
CONDITION	: Under the unit 1.5m	
SOURCE	: 220-240V, 1 phase, 50Hz	

MODEL	: S-60PU2E5B	
SOUND LEVEL	High	36 dB(A)
	Low	28 dB(A)
CONDITION	: Under the unit 1.5m	
SOURCE	: 220-240V, 1 phase, 50Hz	



REMARKS:

- Value obtained in the actual place where the unit is installed may be slightly higher than the values shown in this graph because of the conditions of operation, the structure of the building, the background noise and other factors.
- The test results were obtained from an anechoic room.

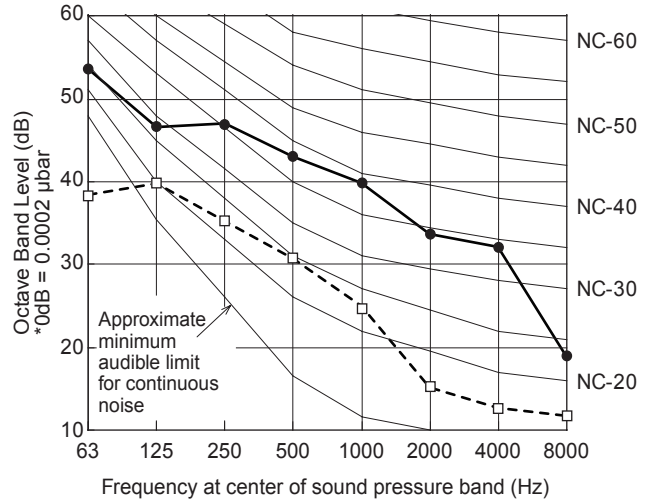
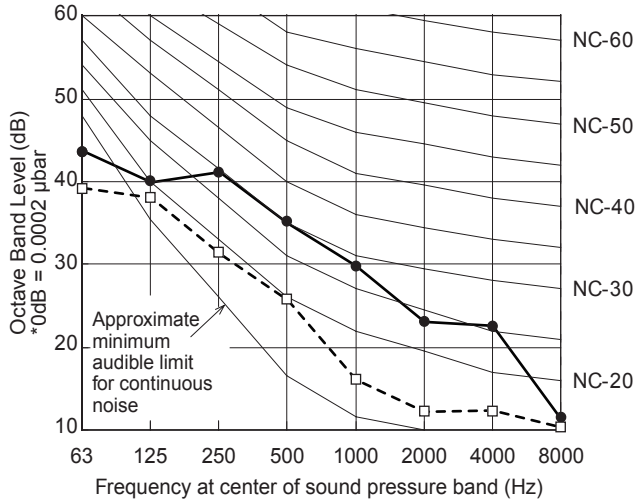
NOTE

To evaluate "Noise level" the maximum number of the measured OCTAVE BAND SOUND PRESSURE LEVEL is used. Read the number on each BAND CENTER FREQUENCIES (horizontal axis) ranging from 63 Hz to 8000 Hz and select the maximum value (vertical axis) among them.

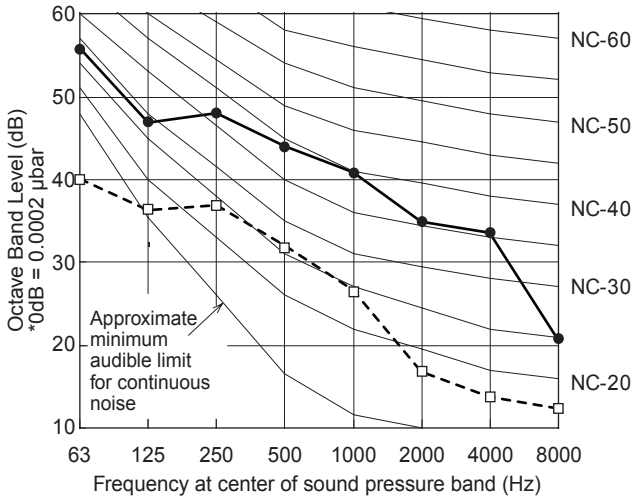
4-Way Cassette Type

MODEL	: S-71PU2E5B
SOUND LEVEL	: High 37 dB(A) Low 28 dB(A)
CONDITION	: Under the unit 1.5m
SOURCE	: 220-240V, 1 phase, 50Hz

MODEL	: S-100PU2E5B
SOUND LEVEL	: High 45 dB(A) Low 32 dB(A)
CONDITION	: Under the unit 1.5m
SOURCE	: 220-240V, 1 phase, 50Hz



MODEL	: S-125PU2E5B
SOUND LEVEL	: High 46 dB(A) Low 33 dB(A)
CONDITION	: Under the unit 1.5m
SOURCE	: 220-240V, 1 phase, 50Hz



REMARKS:

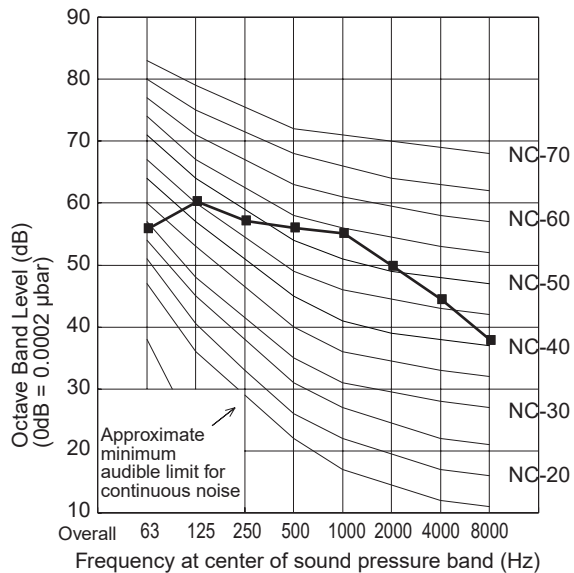
- Value obtained in the actual place where the unit is installed may be slightly higher than the values shown in this graph because of the conditions of operation, the structure of the building, the background noise and other factors.
- The test results were obtained from an anechoic room.

NOTE

To evaluate "Noise level" the maximum number of the measured OCTAVE BAND SOUND PRESSURE LEVEL is used. Read the number on each BAND CENTER FREQUENCIES (horizontal axis) ranging from 63 Hz to 8000 Hz and select the maximum value (vertical axis) among them.

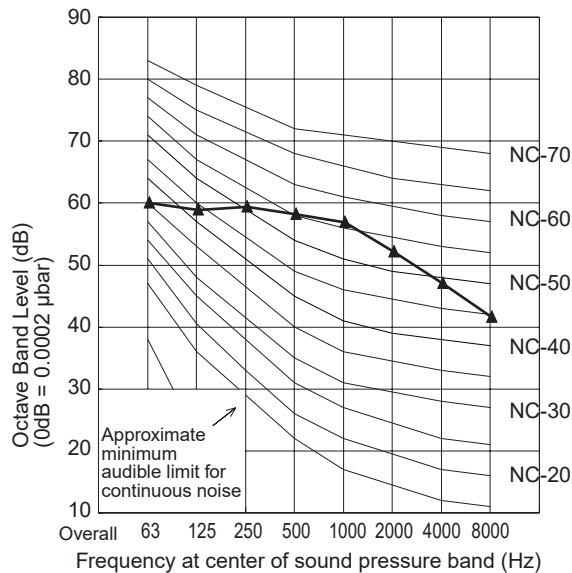
COOLING

MODEL : U-200PZH2E8
 SOUND LEVEL : 59 dB(A)
 CONDITION : 1 m in front at height of 1.5 m



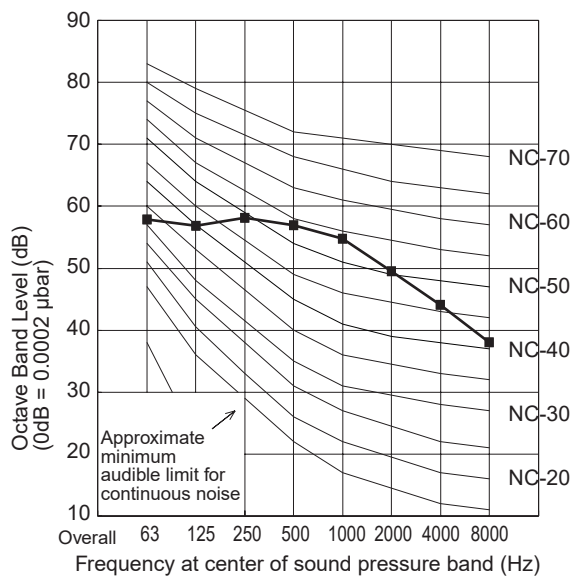
HEATING

MODEL : U-200PZH2E8
 SOUND LEVEL : 61 dB(A)
 CONDITION : 1 m in front at height of 1.5 m



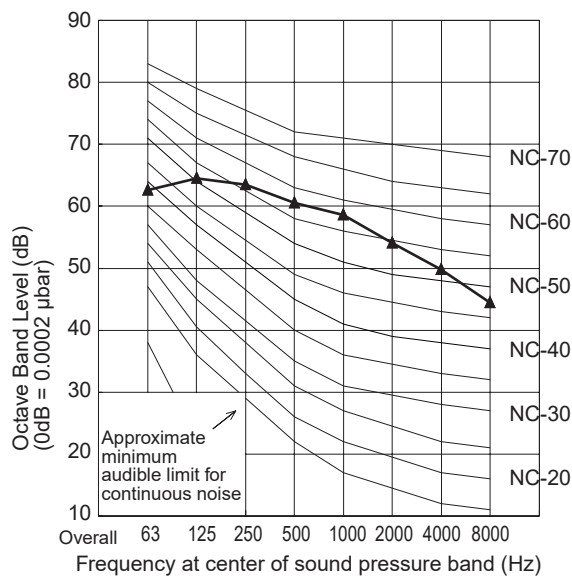
COOLING

MODEL : U-250PZH2E8
 SOUND LEVEL : 59 dB(A)
 CONDITION : 1 m in front at height of 1.5 m



HEATING

MODEL : U-250PZH2E8
 SOUND LEVEL : 63 dB(A)
 CONDITION : 1 m in front at height of 1.5 m



REMARKS:

- Value obtained in the actual place where the unit is installed may be slightly higher than the values shown in this graph because of the conditions of operation, the structure of the building, the background noise and other factors.
- The test results were obtained from an anechoic room.

NOTE

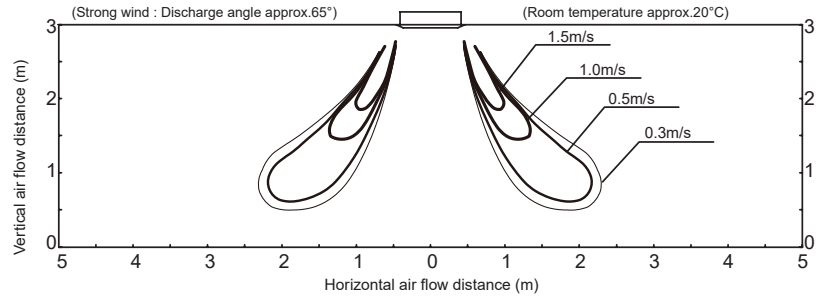
To evaluate "Noise level" the maximum number of the measured OCTAVE BAND SOUND PRESSURE LEVEL is used. Read the number on each BAND CENTER FREQUENCIES (horizontal axis) ranging from 63 Hz to 8000 Hz and select the maximum value (vertical axis) among them.

1-9. Airflow Distance Chart

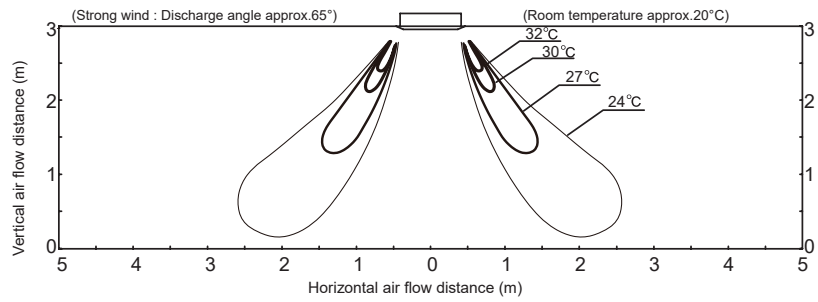
4-Way Cassette (Type U2)

S-50PU2E5B

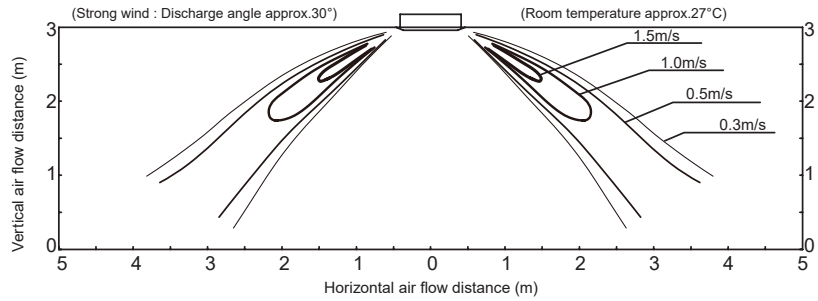
Heating : Distribution of wind velocity



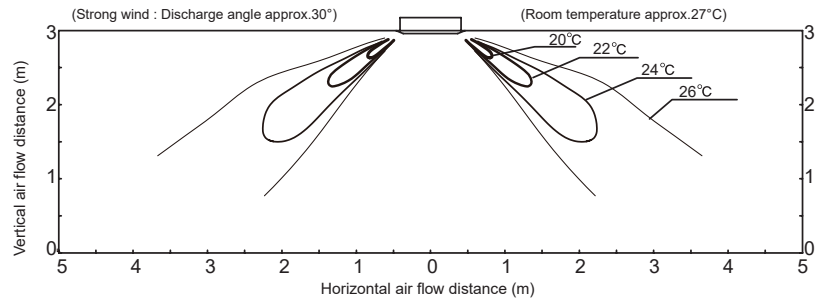
Heating : Distribution of temperature



Cooling : Distribution of wind velocity



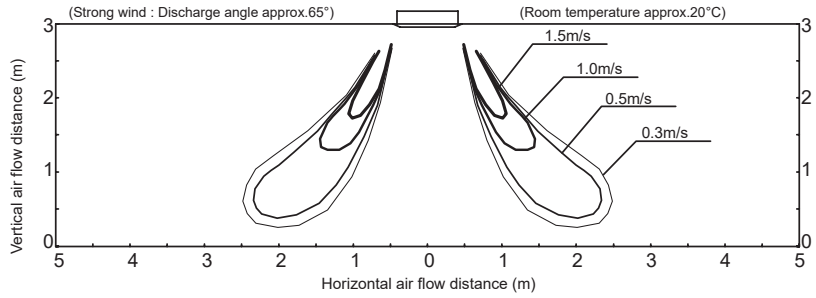
Cooling : Distribution of temperature



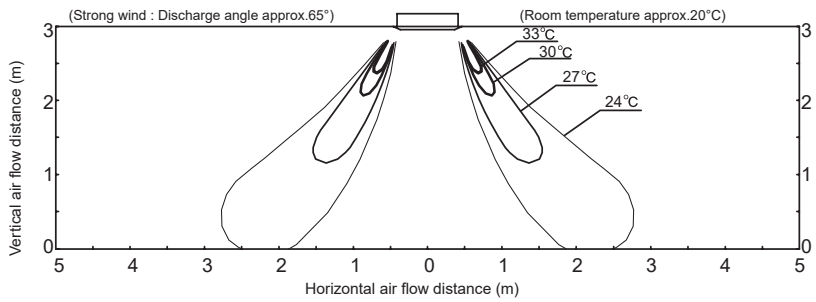
4-Way Cassette (Type U2)

S-60PU2E5B / 71PU2E5B

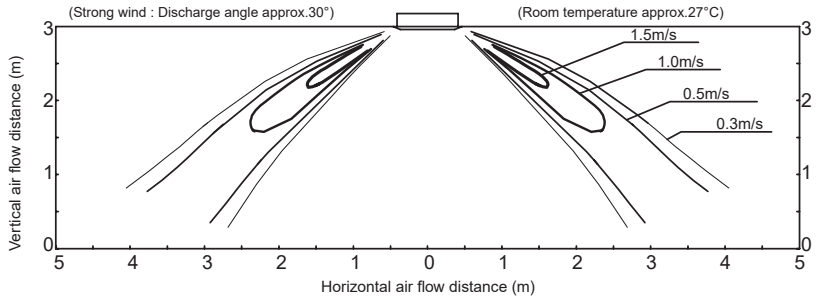
Heating : Distribution of wind velocity



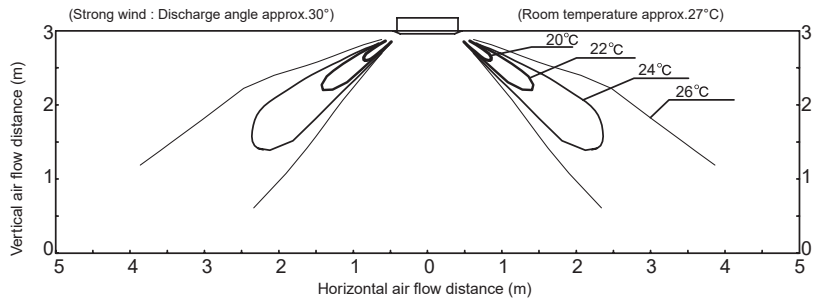
Heating : Distribution of temperature



Cooling : Distribution of wind velocity



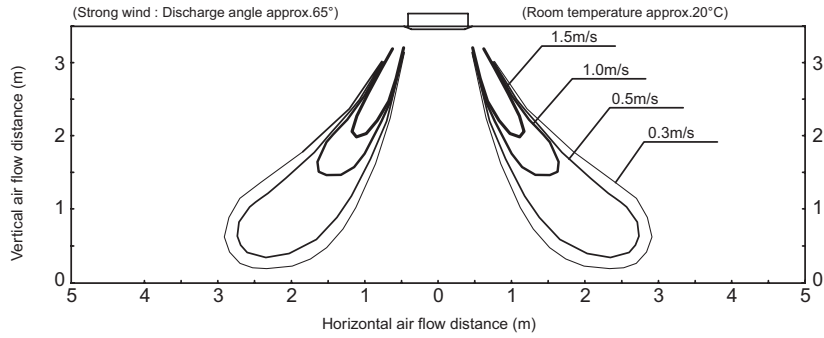
Cooling : Distribution of temperature



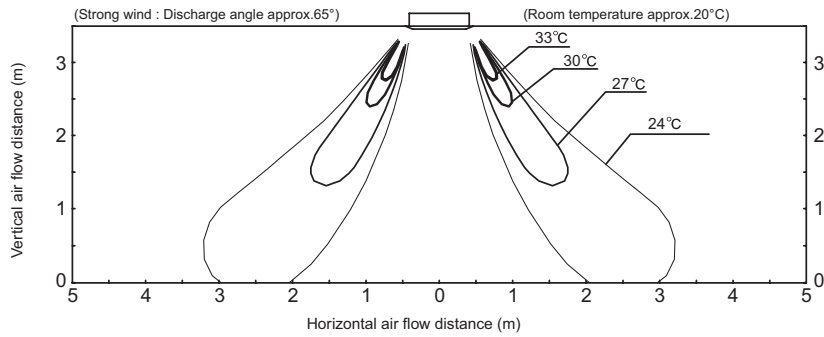
4-Way Cassette (Type U2)

S-100PU2E5B / 125PU2E5B

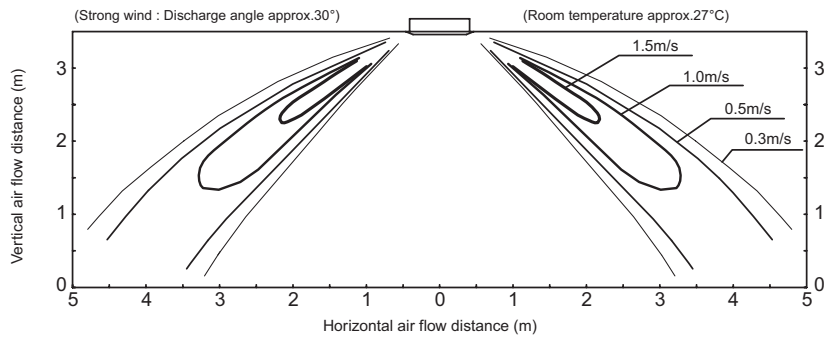
Heating : Distribution of wind velocity



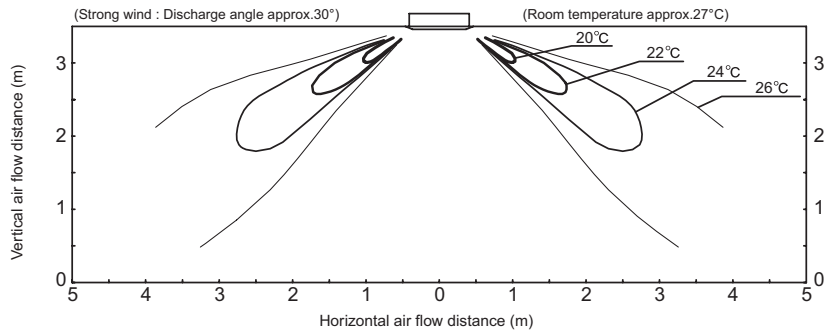
Heating : Distribution of temperature



Cooling : Distribution of wind velocity



Cooling : Distribution of temperature



1-10. Fresh Air Intake

1-10-1. Precautions Regarding External Air Intake

(1) Ventilation Load

Ensure that the design of the air-conditioner takes air-conditioning loads into consideration when external air intake is involved.

(2) Restrictions on External Air Intake

Ensure that the design conforms to the restrictions on air intake volume stipulated in accordance with the model of the indoor unit and the intake method. Consideration must also be taken to mixed air content listed in (3) below without fail.

* If the air intake volume does not satisfy the required ventilation volume, air must be fed into the room separately with the use of a total heat exchanger or a fresh air processing air-conditioner, etc.

(3) Mixed Air

The amount of external air intake must be set within the scope of the unit's usage conditions when external air and internal air is mixed together. This is especially important in the following cases, in which it is necessary to either feed external air into the room after it has been processed or reduce the amount of external air that is fed in.

① When the external dew-point temperature is greater than the dry-bulb temperature of the air sucked into the unit
Ensure that processing is performed so that the external dew-point temperature is lower than the temperature of the air sucked into the unit to prevent the risk of condensation building up.

② In the case of low external temperatures

There are cases in which the temperature of mixed air is lower than the operating range of the unit if excessive amounts of external air intake are used when the external temperature is low.

This problem is to be solved by either feeding external air into the room after it has been processed or reducing the amount of external air that is fed in.

③ When used in combination with humidifiers

External air must always be processed when the external air temperature reaches freezing point to prevent the risk of the humidifier freezing.

(4) Arranging Ducts and Filters in the Field

External air intake ducting must be arranged in the field.

External air filters must also be installed without fail in order to prevent the intake of dust and grit.

(5) Thermal Insulation for Ducts

Ensure that all external air intake ducting is heat-insulated without fail. Failure to observe this may result in the build-up of condensation.

(6) External Air Intake Coupling

Ensure that the design for external air intake is coupled with the fan blower operations of the indoor unit.

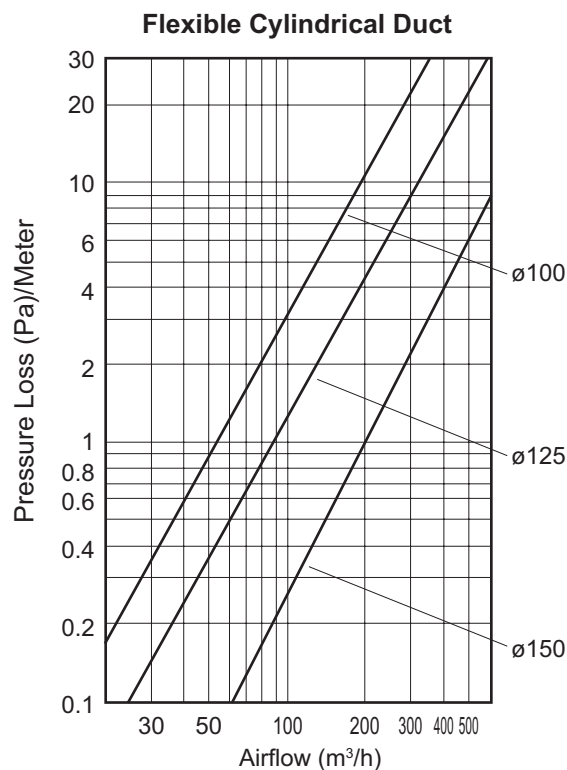
There are cases in which the dust that accumulates in the filter is blown into the room if the external air is fed from the filter. There are also cases in which the noise of external air being fed into the room can be heard from the indoor unit if external air is forcibly fed when the booster fan or other components on the indoor unit are not operating.

(7) Booster Fan Selection

Select the booster fan in accordance with the resistance of the external air intake duct (diagram on the pressure loss characteristics of the air flow volume for flexible cylindrical ducts) and the resistance prevalent inside the unit (external air intake volume & resistance within unit / operation noise characteristics).

(8) Attaching the External Air Intake Flange

Regarding the installation direction of the external air intake duct, refer to the Installation Instructions provided with the external air intake duct.

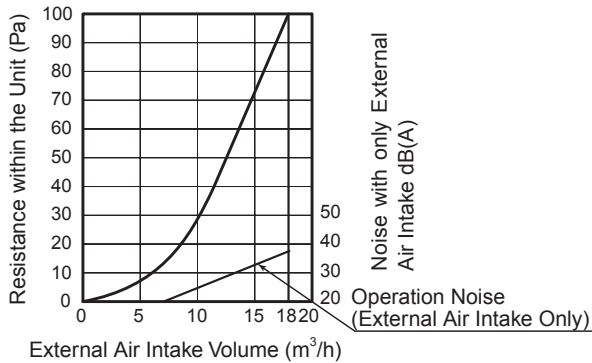


Air Flow Volume for Flexible Cylindrical Duct-Pressure Loss

1-10-2. External Air Intake Volume & Resistance Within Unit / Operation Noise Characteristics

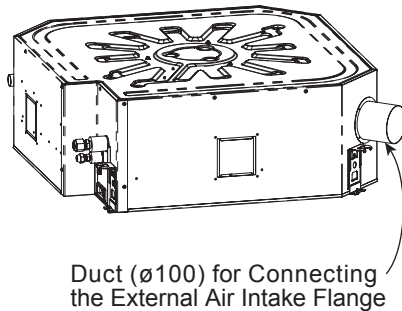
• 4-Way Cassette (Type U2)

When an External Air Intake Flange (ø100) is in Use External Air Intake Volume and Resistance and Operation Noise Characteristics within the Unit



With the External Air Intake Flange Attached

Type U2



- Calculate the operation noise when external air is being fed by combining the noise when only external air is being fed as shown in the graph for operation noise characteristics and the operation noise of the unit as stipulated in the catalogue.
- The operation noise conforms to JIS standards and constitute measurements taken in an anechoic chamber 1.5 m directly beneath the indoor unit. Under normal circumstances, the values shown here are greater owing to the effects of surrounding noise and reverberation when the unit is actually installed.

The amount of external air that is possible to feed when it is fed directly into the unit (ø100)

Type	50	60	71	100	125
Permissible Air Intake Volume (m³/h)	15	17	18	18	18

NOTE

The operation noise for models that use small units is lower, so use values that are within the range shown in the above table. Using values that exceed these will result in noise when only external air is fed being louder than the noise emitted from the unit.

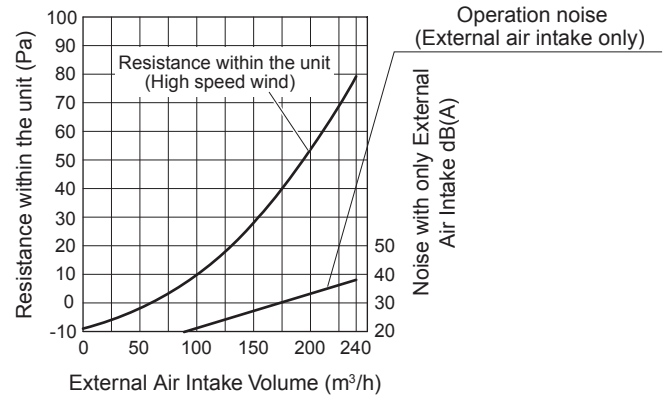


CAUTION

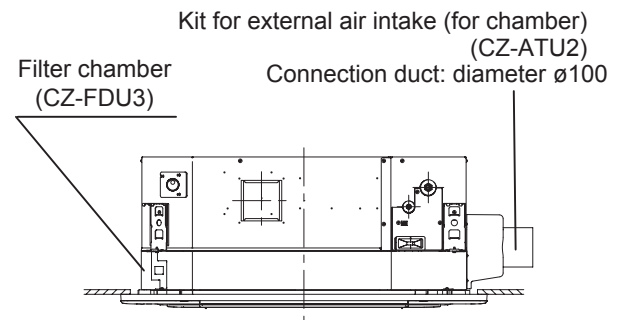
Use the following diagram along with the section "1-10-1. Precautions Regarding External Air Intake".

In a Case of External Air Intake Using Air Intake Chamber (CZ-FDU3+CZ-ATU2)

External Air Intake Volume & Resistance Within Unit/ Operation Noise Characteristics



With the External Air Intake Chamber Attached



- Calculate the operation noise when external air is being fed by combining the noise when only external air is being fed as shown in the diagram for operation noise characteristics and the operation noise of the unit as stipulated in the catalogue.
- The operation noise conforms to JIS standards and constitute measurements taken in an anechoic chamber 1.5m directly below the indoor unit. Under normal circumstances, the diagram shown above is greater owing to the effects of surrounding noise and reverberation when the unit is actually installed.

(CZ-FDU3+CZ-ATU2)

The amount of external air that is possible to feed when external air intake chamber is in use

Type	50	60	71	100	125
Permissible air intake volume (m³/h)	180	190	240	240	240

* The operation noise for models that use small units is lower, so use values that are within the range shown in the above table. Using values that exceed these will result in noise when only external air is fed being louder than the noise emitted from the unit.

1-11. ELECTRICAL WIRING

● General Precautions on Wiring

- (1) Before wiring, confirm the rated voltage of the unit as shown on its nameplate, then carry out the wiring closely following the wiring diagram.



WARNING

- (2) This equipment is strongly recommended to be installed with Earth Leakage Circuit Breaker (ELCB) or Residual Current Device (RCD). Otherwise, it may cause electrical shock and fire in case of equipment breakdown or insulation breakdown. Earth Leakage Circuit Breaker (ELCB) must be incorporated in the fixed wiring in accordance with the wiring regulations. The Earth Leakage Circuit Breaker (ELCB) must be an approved 10-16 A, having a contact separation in all poles.
- (3) To prevent possible hazards from insulation failure, the unit must be grounded.
- (4) Each wiring connection must be done in accordance with the wiring system diagram. Wrong wiring may cause the unit to misoperate or become damaged.
- (5) Do not allow wiring to touch the refrigerant tubing, compressor, or any moving parts of the fan.
- (6) Unauthorized changes in the internal wiring can be very dangerous. The manufacturer will accept no responsibility for any damage or misoperation that occurs as a result of such unauthorized changes.
- (7) Regulations on wire diameters differ from locality to locality. For field wiring rules, please refer to your LOCAL ELECTRICAL CODES before beginning. You must ensure that installation complies with all relevant rules and regulations.
- (8) To prevent malfunction of the air conditioner caused by electrical noise, care must be taken when wiring as follows:
- The remote control wiring and the inter-unit control wiring should be wired apart from the power supply wiring.
 - Use shielded wires for inter-unit control wiring between units and ground the shield on both sides.
- (9) If the power supply cord of this appliance is damaged, it must be replaced by a repair shop designated by the manufacturer, because special-purpose tools are required.



CAUTION

Check local electrical codes and regulations before wiring. Also, check any specified instruction or limitations.

Recommended Wire Length and Wire Diameter for Power Supply System

Indoor unit

Type	(B) Power supply	Time delay fuse or circuit capacity
	2.5 mm ²	
E3	Max. 30 m	10-16 A
U2	Max. 130 m	10-16 A

Control wiring

(C) Inter-unit control wiring (between outdoor and indoor units)	(D) Remote control wiring	(E) Control wiring for group control
0.75 mm ² (AWG #18) Use shielded wiring*	0.75 mm ² (AWG #18)	0.75 mm ² (AWG #18)
Max. 1,000 m	Max. 500 m	Max. 200 m (Total)

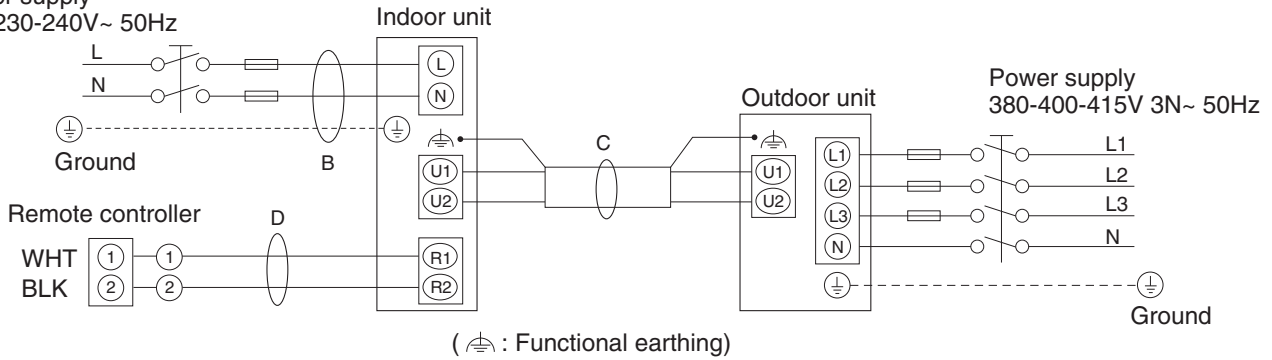
NOTE

* With ring-type wire terminal.

■ Wiring System Diagrams

<Type E3>

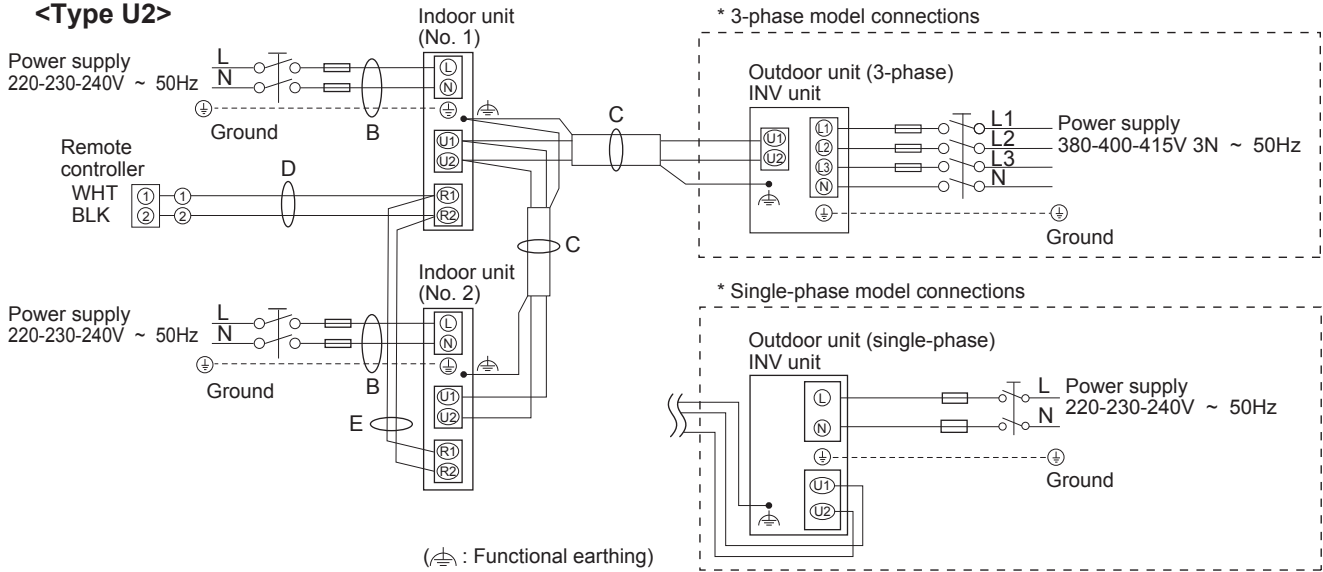
Power supply
220-230-240V ~ 50Hz



(⚡ : Functional earthing)

<Type U2>

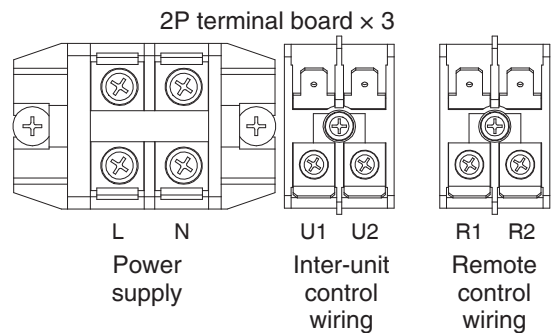
Power supply
220-230-240V ~ 50Hz



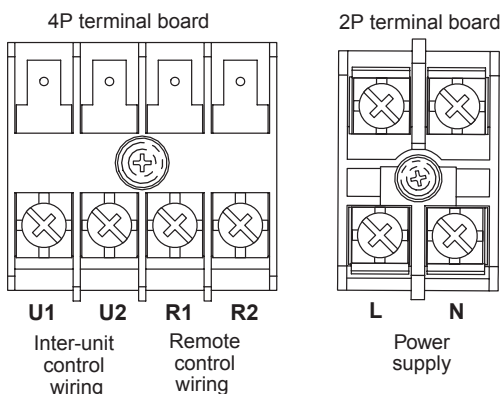
(⚡ : Functional earthing)

NOTE

- (1) See the "Recommended Wire Length and Wire Diameter for Power Supply System" for the explanation of "B", "C", "D" and "E" in the above diagram.
- (2) The basic connection diagram of the indoor unit shows the terminal boards, so the terminal boards in your equipment may differ from the diagram.
- (3) Refrigerant Circuit (R.C.) address should be set before turning the power on.
- (4) Regarding R.C. address setting, refer to the installation instructions supplied with the outdoor unit. Auto address setting can be executed by remote controller automatically. Refer to the installation instructions supplied with the remote controller (optional).



Type E3

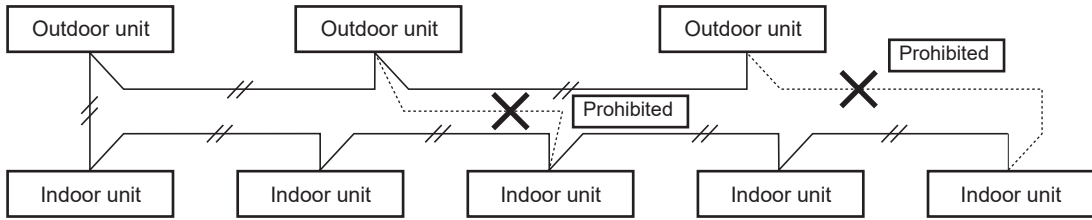


Type U2

CAUTION

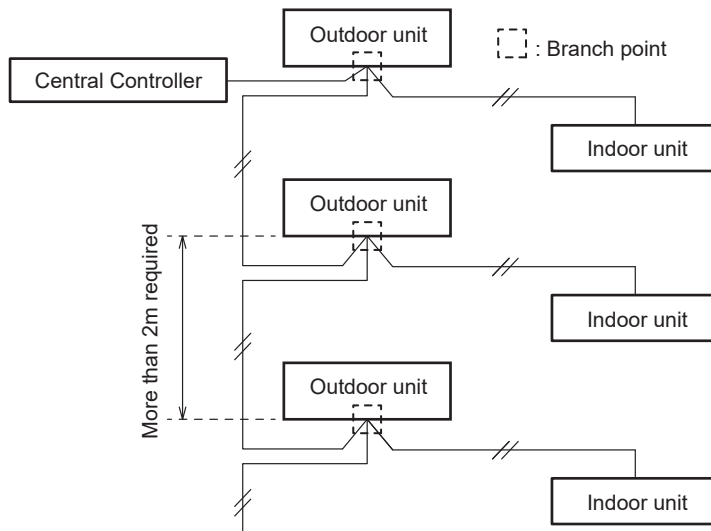
(1) When linking the outdoor units in a network, disconnect the terminal extended from the short plug from all outdoor units except any one of the outdoor units. (When shipping: In shorted condition.)
 For a system without link (no wiring connection between outdoor units), do not remove the short plug.

(2) Do not install the inter-unit control wiring in a way that forms a loop.

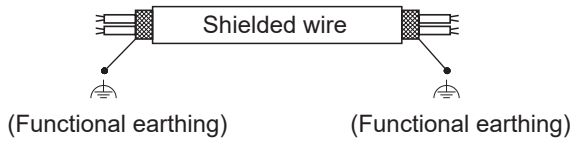


<Type E3>

(3) If branching the inter-unit control wiring, the number of branch points should be 16 or fewer.



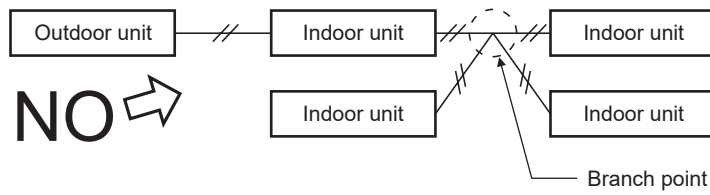
(4) Use shielded wires for inter-unit control wiring (C) and ground the shield on both sides, otherwise misoperation from noise may occur.
 Connect wiring as shown in Section “■ Wiring System Diagrams” on page 1-11-2.



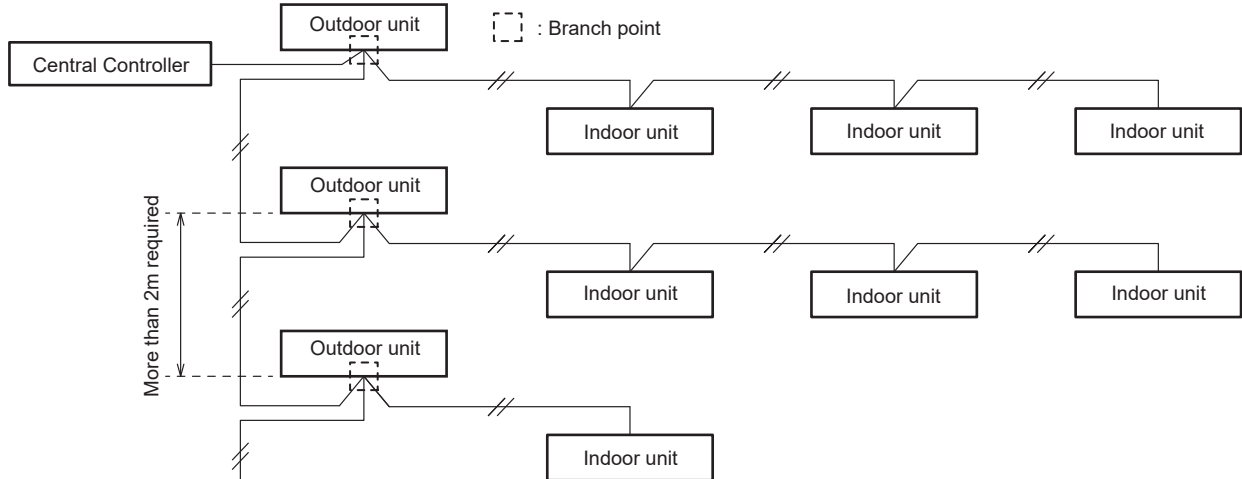
(5) Use the standard power supply cables for Europe (such as H05RN-F or H07RN-F which conform to CENELEC (HAR) rating specifications) or use the cables based on IEC standard. (60245 IEC57, 60245 IEC66)

<Type U2>

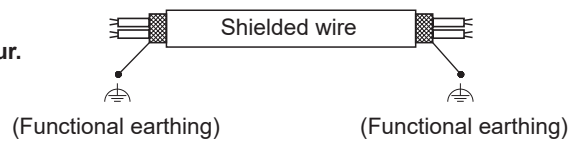
(3) Do not install inter-unit control wiring such as star branch wiring. Star branch wiring causes mis-address setting.



(4) If branching the inter-unit control wiring, the number of branch points should be 16 or fewer.



(5) Use shielded wires for inter-unit control wiring (C) and ground the shield on both sides, otherwise misoperation from noise may occur. Connect wiring as shown in Section "■ Wiring System Diagrams" on page 1-11-2.



(6) • Connecting cable between indoor unit and outdoor unit shall be approved polychloroprene sheathed 5 or 3 *1.5 mm² flexible cord. Type designation 60245 IEC57 (H05RN-F, GP85PCP etc.) or heavier cord.

- Use the standard power supply cables for Europe (such as H05RN-F or H07RN-F which conform to CENELEC (HAR) rating specifications) or use the cables based on IEC standard. (60245 IEC57, 60245 IEC66)

⚠ WARNING

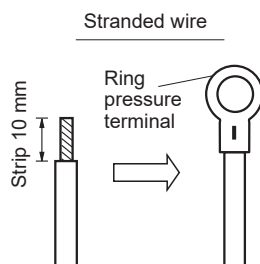
Loose wiring may cause the terminal to overheat or result in unit malfunction. A fire hazard may also occur. Therefore, ensure that all wiring is tightly connected.

When connecting each power wire to the terminal, follow the instructions on "How to connect wiring to the terminal" and fasten the wire securely with the terminal screw.

How to connect wiring to the terminal

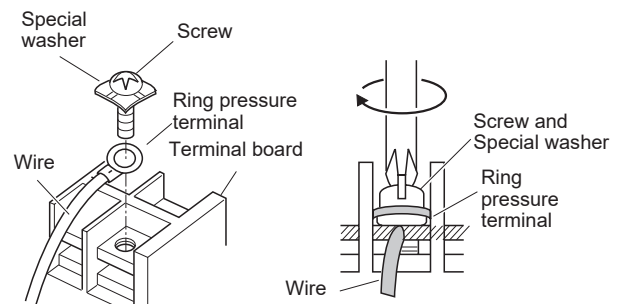
■ For stranded wiring

- (1) Cut the wire end with cutting pliers, then strip the insulation to expose the stranded wiring about 10 mm and tightly twist the wire ends.



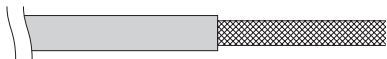
- (2) Using a Phillips head screwdriver, remove the terminal screw(s) on the terminal board.

- (3) Using a ring connector fastener or pliers, securely clamp each stripped wire end with a ring pressure terminal.
- (4) Place the ring pressure terminal, and replace and tighten the removed terminal screw using a screwdriver.

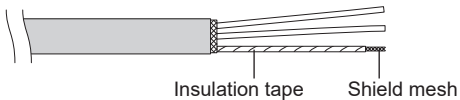


■ Examples of shield wires

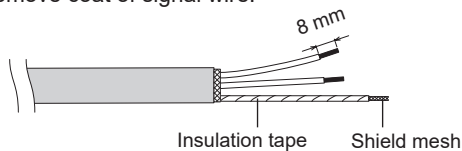
(1) Remove cable coat not to scratch braided shield.



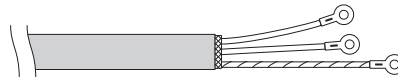
(2) Unbraid the braided shield carefully and twist the unbraided shield wires tightly together. Insulate the shield wires by covering them with an insulation tube or wrapping insulation tape around them.



(3) Remove coat of signal wire.



(4) Attach ring pressure terminals to the signal wires and the shield wires insulated in Step (2).



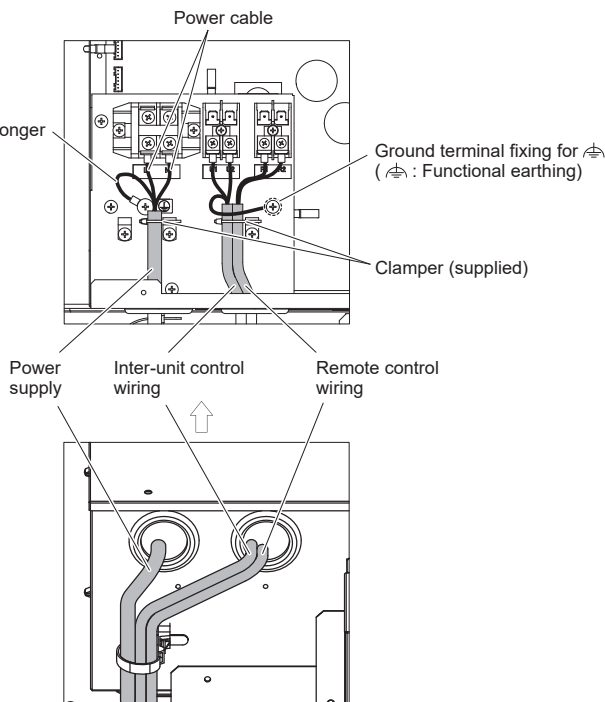
■ Earth wire for power supply

The earth wire should be longer than the other lead wires for electrical safety.

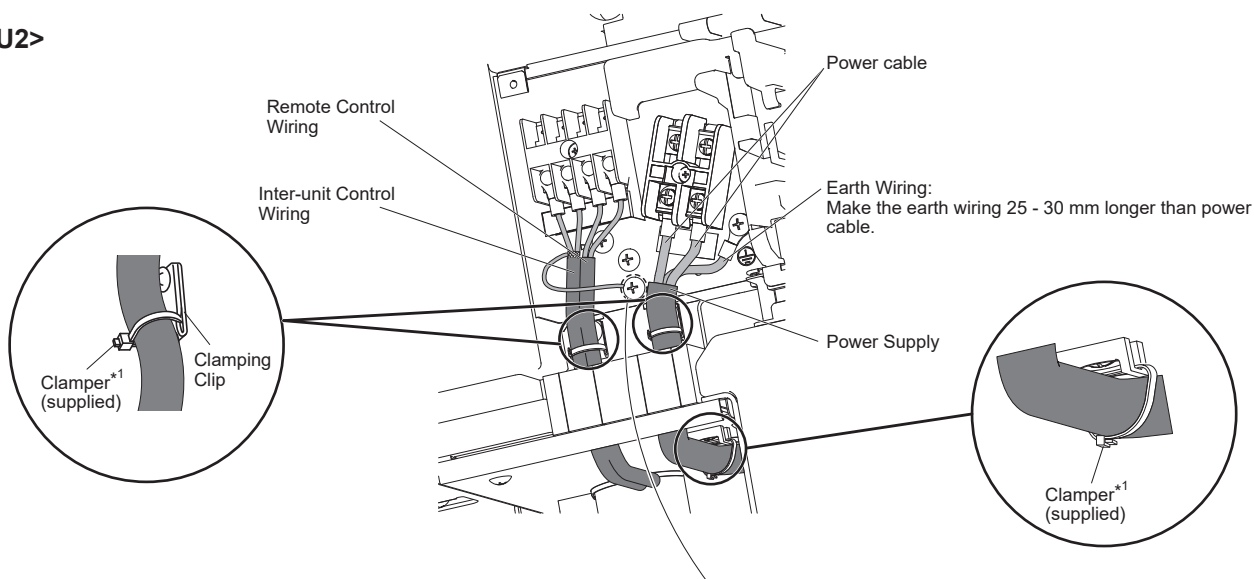
■ Wiring samples

<Type E3>

Earth wiring:
Make the earth wiring 25 - 30 mm longer than power cable.



<Type U2>



*1 Fasten tightly.

Use this screw when connecting the shield for the Inter-unit control wiring to ground.
(⏏ : Functional earthing)

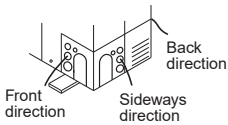
U-200PZH2E8, U-250PZH2E8

WARNING	This air conditioner must be installed in accordance with national wiring regulations.
	Cables connected to outdoor unit must be approved polychloroprene sheathed type 60245 IEC57 or H05RN-F/H07RN-F or heavier.
	The units must be connected to the supply cables for fixed wiring by qualified technician. Circuit breaker must be incorporated in the fixed wiring in accordance with the national wiring regulations. The circuit breaker must be approved, suitable for the voltage and current ratings of equipment and have a contact separation by 3mm in all poles.
	When the supply cable is damaged, it must be replaced by qualified technician.
	Be sure to install a current leakage breaker, main switch and fuse to the main power supply, otherwise electric shocks may result.
	Be sure to connect the unit to secure earth connection. If the earthing work is not carried out properly, electric shocks may result.
	Wiring shall be connected securely by using specified cables and fix them securely so that external force of the cables may not transfer to the terminal connection section. Imperfect connection and fixing leads to fire, etc.

- Ensure to connect the electrical cable connections and clamp the wires securely to the terminal connections using cord clamps so that no undue force is placed on the wires (power source cable, indoor/outdoor connection cables, earth lead wire).
- Do not install a phase advance capacitor for power factor improvement. (It does not improve the power factor and will cause abnormal overheating.)
- Do not bind the excess cables together and place them inside this unit.
- Protect the electrical cable with the protective bushing provided so that the cables do not get damaged on the knock hole or etched portions. If there is space between the electrical cables and the protective bushing occurs, seal it accordingly.
- Tie the cables with the provided binding strap so that they do not touch the compressor and the tubes.
- When setting up the cables, inside of unit install properly so that the front panel will not lift up. Make sure that front panel mount correctly.
- Use a round type terminal with an insulation sleeve for connecting to the terminal block.
- Use the appropriate screwdriver for tightening the terminal screws. Small sized screwdriver damages the head of the screw and cannot tighten it properly.
- There is risk of damaging the screw if the terminal screw is over tightened. Tighten with the appropriate torque.

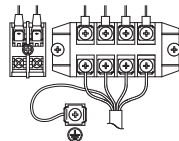
Screw diameter name	Tightening torque N•m{kgf•cm}
M4	1.57~1.96 {16~20}
M5	1.96~2.45 {20~25}
M6	4.00~4.50 {41~46}

- Direction to pull out wires



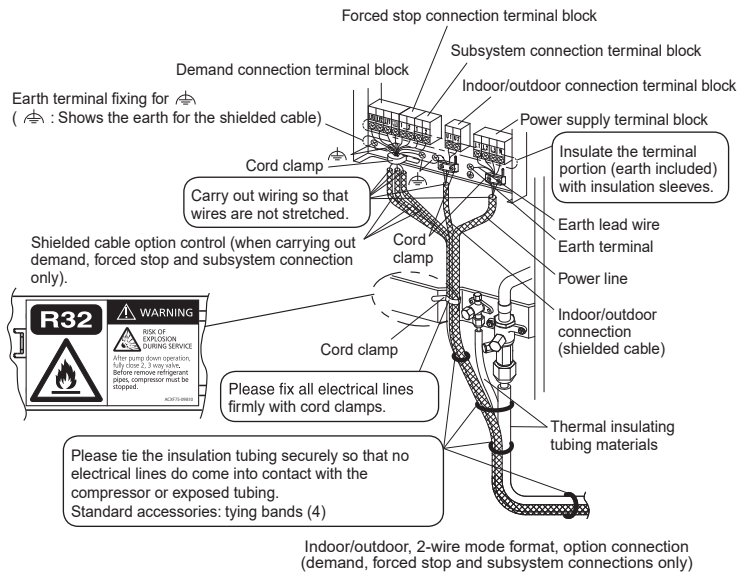
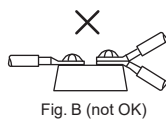
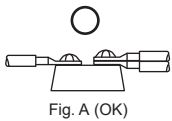
Seal wiring holes after wiring using included protection bush. (other holes are for connecting conduit tube)

- Earth lead wire set up

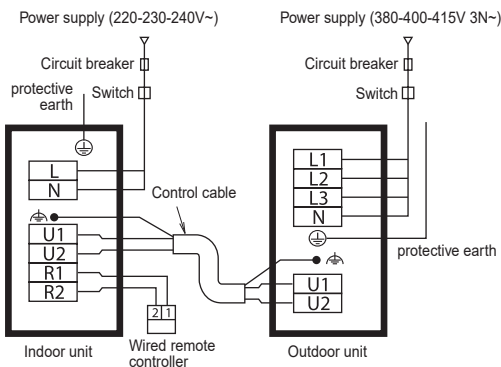


The earth lead wire shall be longer than other lead wires as shown in the figure for electrical safety in case it slips out of the cord from the anchorage.

- Be sure to connect the wires correctly to terminal board with connecting the crimp type ring terminal to the wires.
- If connecting two separate wires to a single crimped terminal, place the two crimped terminal wires together as shown in Fig. A. (If the arrangement shown in Fig. B is used, poor contacts or contact damage may result.)



Wiring System Diagrams



This equipment complies with EN/IEC 61000-3-12 provided that the short-circuit power S_{sc} is greater than or equals to *2 kVA at the interface point between the user's supply and the public system. It is the responsibility of the installer or user of the equipment to ensure; by consultation with the distribution network operator if necessary that the equipment is connected only to supply with a short-circuit power S_{sc} greater than or equals to *2 kVA.

S_{sc} : Short circuit power ⏏: functional earthing (for the shielded cable)

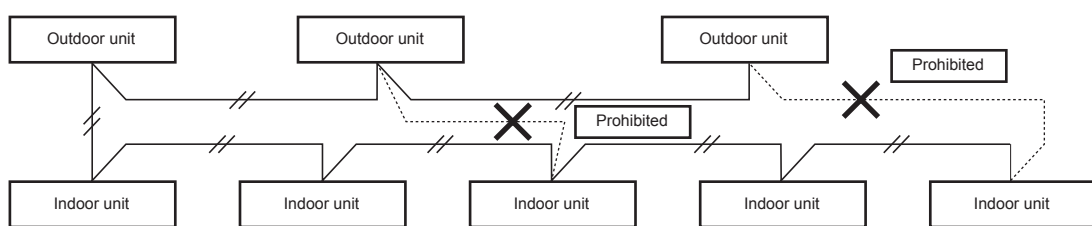
Model name	Power supply	Time delay fuse or circuit capacity	*1 Control cable	*2 S_{sc}
U-200PZH2E8	380-400-415V 3N~	30 A	0.75 mm ²	*3
U-250PZH2E8	380-400-415V 3N~	30 A	0.75 mm ²	1850 kVA

*1 Use a shielded cable for the control cable. Overall extension less than 1000m.

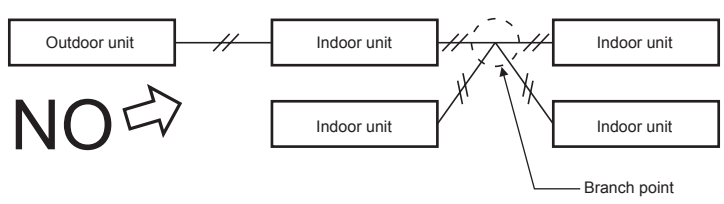
*3 Intended for professional use. Permission from the power supplier is required when installing the U-200PZH2E8 outdoor units that are connected to a 16 A distribution network.

- The product meets the technical requirements of EN/IEC 61000-3-3.
- Decide the length and size of the power supply cable based on the maximum ampere tabulated above in accordance with the national wiring regulations.
- Select the fuse(s) and/or circuit breaker(s) from the types and ratings suitable for the maximum ampere tabulated above in accordance with the national wiring regulations.
- If capacity of power supply circuit and enforcement are not enough, it can causes the electric shock and a fire.

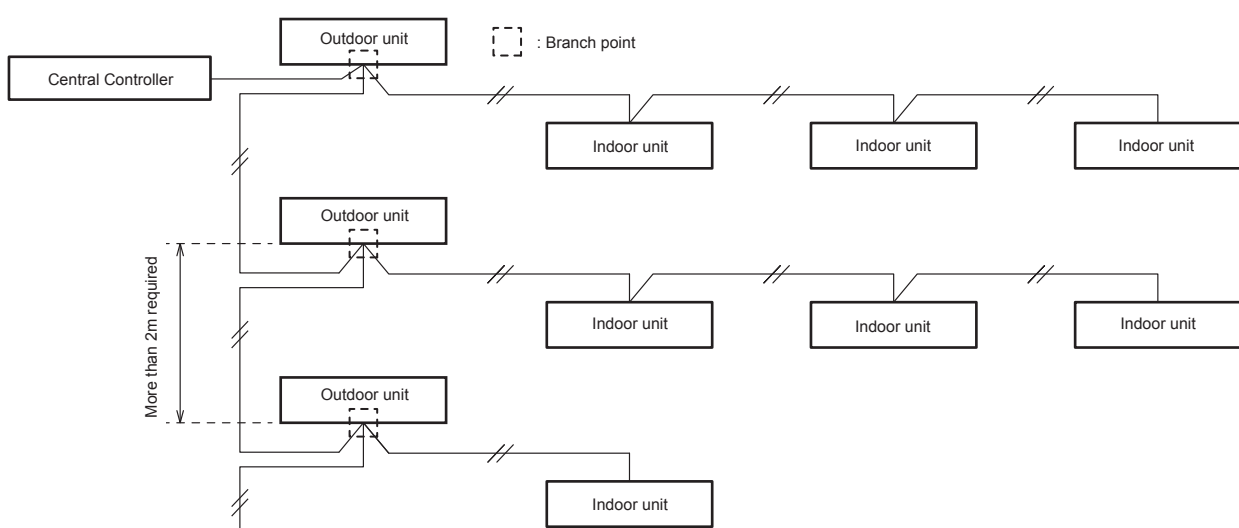
- (1) When linking the outdoor units in a network, disconnect the terminal extended from the short plug from all outdoor units except any one of the outdoor units. (When shipping: In shorted condition.)
For a system without link (no wiring connection between outdoor units), do not remove the short plug.
- (2) Do not install the inter-unit control wiring in a way that forms a loop.



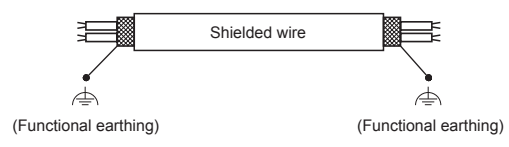
- (3) Do not install inter-unit control wiring such as star branch wiring. Star branch wiring causes mis-address setting.



- (4) If branching the inter-unit control wiring, the number of branch points should be 16 or fewer.



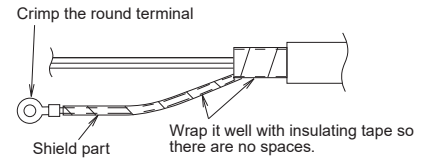
- (5) Use shielded wires for inter-unit control wiring and ground the shield on both sides, otherwise misoperation from noise may occur. Connect wiring as shown in Section "■ Wiring System Diagrams" on page 1-11-2.



- (6) Use the standard power supply cables for Europe (such as H05RN-F or H07RN-F which conform to CENELEC (HAR) rating specifications) or use the cables based on IEC standard. (60245 IEC57, 60245 IEC66)

<p>WARNING</p>	<p>Loose wiring may cause the terminal to overheat or result in unit malfunction. A fire hazard may also occur. Therefore, ensure that all wiring is tightly connected.</p> <p>When connecting each power wire to the terminal, follow the instructions on "How to connect wiring to the terminal" and fasten the wire securely with the terminal screw.</p>
-----------------------	--

For the shield part of the shielded cable, twist the end out, crimp it with a round terminal, and connect it to the functional earthing screw.
After crimping it with a round terminal, wrap it with insulating tape so there are no spaces and adjust it so the shield part does not touch any live parts.



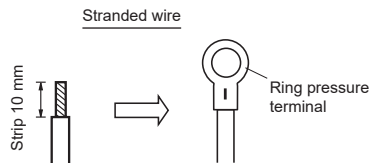
CAUTION

Be sure that the shield part of the shielded cable does not touch the terminal block or any live parts. Failure to do so may lead to electric shock or fire.

How to connect wiring to the terminal

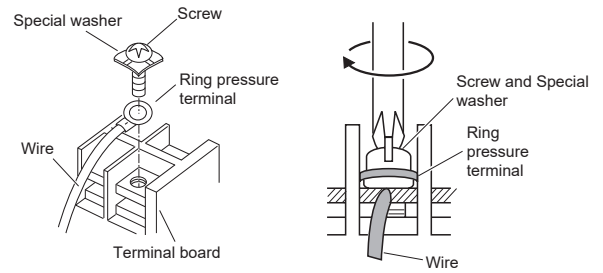
■ For stranded wires

- (1) Cut the wire end with cutting pliers, then strip the insulation to expose the stranded wire about 10 mm and tightly twist the wire ends.



- (2) Using a Phillips head screwdriver, remove the terminal screw(s) on the terminal board.
(3) Using a ring connector fastener or pliers, securely clamp each stripped wire end with a ring pressure terminal.

- (4) Put the removed terminal screw through the ring pressure terminal and then replace and tighten the terminal screw using a screwdriver.



1-12. Installation Instructions








■ Outdoor Unit

1. U-200PZH2E8, U-250PZH2E8

PRECAUTION FOR USING R32 REFRIGERANT

- The basic installation work procedures are the same as conventional refrigerant (R410A, R22) models.

However, pay careful attention to the following points:

 WARNING	
	Since the working pressure is higher than that of refrigerant R22 models, some of the piping and installation and service tools are special.
	Models that use refrigerant R32 and R410A have a different charging port thread diameter to prevent erroneous charging with refrigerant R22 and for safety. Therefore, check beforehand.
	Be more careful than R22 so that foreign matter (oil, water, etc.) does not enter the piping. Also, when storing the piping, securely seal the opening by pinching, taping, etc. (Handling of R32 is similar to R410A.)
 CAUTION	
	<p>1. Installation (Space)</p> <ul style="list-style-type: none"> • That the installation of pipe-work shall be kept to a minimum. • Must ensure that pipe-work shall be protected from physical damage. • That compliance with national gas regulations shall be observed. • Must ensure mechanical connections be accessible for maintenance purposes. • In cases that require mechanical ventilation, ventilation openings shall be kept clear of obstruction. • When disposal of the product, do follow to the precautions in “12. Recovery” on page 1-12-1-1-6 and comply with national regulations. Always contact to local municipal offices for proper handling.
	<p>2. Servicing</p> <p style="border: 1px solid black; border-radius: 10px; padding: 2px; display: inline-block;">2-1. Service personnel</p> <ul style="list-style-type: none"> • Any qualified person who is involved with working on or breaking into a refrigerant circuit should hold a current valid certificate from an industry-accredited assessment authority, which authorizes their competence to handle refrigerants safely in accordance with an industry recognised assessment specification.

- Servicing shall only be performed as recommended by the equipment manufacturer. Maintenance and repair requiring the assistance of other skilled personnel shall be carried out under the supervision of the person competent in the use of flammable refrigerants.
- Servicing shall be performed only as recommended by the manufacturer.

2-2. Work

- Prior to beginning work on systems containing flammable refrigerants, safety checks are necessary to ensure that the risk of ignition is minimised.
For repair to the refrigerating system, “2-3. General work area” on page 1-12-1-1-2 to “2-7. Ventilated area” on page 1-12-1-1-2 shall be completed prior to conducting work on the system.
- Work shall be undertaken under a controlled procedure so as to minimise the risk of a flammable gas or vapour being present while the work is being performed.

2-3. General work area

- All maintenance staff and others working in the local area shall be instructed on the nature of work being carried out.
- Work in confined spaces shall be avoided.
- The area around the workspace shall be sectioned off.
- Ensure that the conditions within the area have been made safe by control of flammable material.

2-4. Checking for presence of refrigerant

- The area shall be checked with an appropriate refrigerant detector prior to and during work, to ensure the technician is aware of potentially toxic or flammable atmospheres.
- Ensure that the leak detection equipment being used is suitable for use with all applicable refrigerants, i.e. non-sparking, adequately sealed or intrinsically safe.

2-5. Presence of fire extinguisher

- If any hot work is to be conducted on the refrigeration equipment or any associated parts, appropriate fire extinguishing equipment shall be available to hand.
- Have a dry powder or CO₂ fire extinguisher adjacent to the charging area.

2-6. No ignition sources

- No person carrying out work in relation to a refrigeration system which involves exposing any pipe work shall use any sources of ignition in such a manner that it may lead to the risk of fire or explosion.
- All possible ignition sources, including cigarette smoking, should be kept sufficiently far away from the site of installation, repairing, removing and disposal, during which refrigerant can possibly be released to the surrounding space.
- Prior to work taking place, the area around the equipment is to be surveyed to make sure that there are no flammable hazards or ignition risks.
- “No Smoking” signs shall be displayed.

2-7. Ventilated area

- Ensure that the area is in the open or that it is adequately ventilated before breaking into the system or conducting any hot work.
- A degree of ventilation shall continue during the period that the work is carried out.
- The ventilation should safely disperse any released refrigerant and preferably expel it externally into the atmosphere.

2-8. Checks to the refrigeration equipment

- Where electrical components are being changed, they shall be fit for the purpose and to the correct specification.
- At all times the manufacturer's maintenance and service guidelines shall be followed.
- If in doubt, consult the manufacturer's technical department for assistance.
 - The charge size is in accordance with the room size within which the refrigerant containing parts are installed;
 - The ventilation machinery and outlets are operating adequately and are not obstructed;
 - Marking to the equipment continues to be visible and legible. Markings and signs that are illegible shall be corrected;
 - Refrigeration pipe or components are installed in a position where they are unlikely to be exposed to any substance which may corrode refrigerant containing components, unless the components are constructed of materials which are inherently resistant to being corroded or are suitably protected against being so corroded.

2-9. Checks to electrical devices

- Repair and maintenance to electrical components shall include initial safety checks and component inspection procedures.
- If a fault exists that could compromise safety, then no electrical supply shall be connected to the circuit until it is satisfactorily dealt with.
- If the fault cannot be corrected immediately but it is necessary to continue operation, an adequate temporary solution shall be used.
- This shall be reported to the owner of the equipment so all parties are advised.
- Initial safety checks shall include:
 - That capacitors are discharged. This shall be done in a safe manner to avoid possibility of sparking;
 - That no live electrical components and wiring are exposed while charging, recovering or purging the system;
 - That there is continuity of earth bonding.

3. Repairs to sealed components

- During repairs to sealed components, all electrical supplies shall be disconnected from the equipment being worked upon prior to any removal of sealed covers, etc.
- Particular attention shall be paid to the following to ensure that by working on electrical components, the casing is not altered in such a way that the level of protection is affected. This shall include damage to cables, excessive number of connections, terminals not made to original specification, damage to seals, incorrect fitting of glands, etc.
- ❗ • Ensure that apparatus is mounted securely.
- Ensure that seals or sealing materials have not degraded to the point that they no longer serve the purpose of preventing the ingress of flammable atmospheres.
- Replacement parts shall be in accordance with the manufacturer's specifications.

NOTE: The use of silicon sealant can inhibit the effectiveness of some types of leak detection equipment.
Intrinsically safe components do not have to be isolated prior to working on them.

4. Repair to intrinsically safe components

- Do not apply any permanent inductive or capacitance loads to the circuit without ensuring that this will not exceed the permissible voltage and current permitted for the equipment in use.
- ❗ • Intrinsically safe components are the only types that can be worked on while live in the presence of a flammable atmosphere. The test apparatus shall be at the correct rating.
- Replace components only with parts specified by the manufacturer.
- Other parts may result in the ignition of refrigerant in the atmosphere from a leak.

5. Cabling

- ❗ • Check that cabling will not be subject to wear, corrosion, excessive pressure, vibration, sharp edges or any other adverse environmental effects.
- The check shall also take into account the effects of aging or continual vibration from sources such as compressors or fans.

<p>❗</p>	<p>6. Detection of flammable refrigerants</p> <ul style="list-style-type: none"> • Under no circumstances shall potential sources of ignition be used in the searching for or detection of refrigerant leaks. • A halide torch (or any other detector using a naked flame) shall not be used.
<p>❗</p> <p>❗</p>	<p>7. Leak detection methods</p> <ul style="list-style-type: none"> • Electronic leak detectors may be used to detect refrigerant leaks but, in the case of flammable refrigerants, the sensitivity may not be adequate, or may need re-calibration. (Detection equipment shall be calibrated in a refrigerant-free area.) • Ensure that the detector is not a potential source of ignition and is suitable for the refrigerant used. • Leak detection equipment shall be set at a percentage of the lower flammable limit (LFL) of the refrigerant and shall be calibrated to the refrigerant employed, and the appropriate percentage of gas (25 % maximum) is confirmed. • Leak detection fluids are suitable for use with most refrigerants but the use of detergents containing chlorine shall be avoided as the chlorine may react with the refrigerant and corrode the copper pipe-work. • If a leak is suspected, all naked flames shall be removed/extinguished. • If a leakage of refrigerant is found which requires brazing, all of the refrigerant shall be recovered from the system, or isolated (by means of shut off valves) in a part of the system remote from the leak. For appliances containing flammable refrigerants, Oxygen free nitrogen (OFN) shall then be purged through the system both before and during the brazing process.
<p>❗</p>	<p>8. Removal and evacuation</p> <ul style="list-style-type: none"> • When breaking into the refrigerant circuit to make repairs-or for any other purpose-conventional procedures shall be used. However, it is important that best practice is followed since flammability is a consideration. The following procedure shall be adhered to: <ul style="list-style-type: none"> • Remove refrigerant; • Purge the circuit with inert gas; • Evacuate; • Purge again with inert gas; • Open the circuit by cutting or brazing. • The refrigerant charge shall be recovered into the correct recovery cylinders. • The system shall be “flushed” with Oxygen free nitrogen (OFN) to render the unit safe. This process may need to be repeated several times. • Compressed air or oxygen shall not be used for purging refrigerant systems. • Flushing shall be achieved by breaking the vacuum in the system with Oxygen free nitrogen (OFN) and continuing to fill until the working pressure is achieved, then venting to atmosphere, and finally pulling down to a vacuum. • This process shall be repeated until no refrigerant is within the system. • When the final Oxygen free nitrogen (OFN) charge is used, the system shall be vented down to atmospheric pressure to enable work to take place. • This operation is absolutely vital if brazing operations on the pipe-work are to take place. • Ensure that the outlet for the vacuum pump is not close to any ignition sources and that ventilation is available.

9. Charging procedures

- In addition to conventional charging procedures, the following requirements shall be followed.
 - Ensure that contamination of different refrigerants does not occur when using charging equipment.
 - Hoses or lines shall be as short as possible to minimize the amount of refrigerant contained in them.
 - Cylinders shall be kept upright.
 - Ensure that the refrigeration system is earthed prior to charging the system with refrigerant.
 - Label the system when charging is complete (if not already).
 - Extreme care shall be taken not to over fill the refrigeration system.
- Prior to recharging the system it shall be pressure tested with the appropriate purging gas.
- The system shall be leak-tested on completion of charging but prior to commissioning.
- A follow up leak test shall be carried out prior to leaving the site.
- Electrostatic charge may accumulate and create a hazardous condition when charging or discharging the refrigerant.

To avoid fire or explosion, dissipate static electricity during transfer by grounding and bonding containers and equipment before charging/discharging.

10. Decommissioning

- Before carrying out this procedure, it is essential that the technician is completely familiar with the equipment and all its detail.
- It is recommended good practice that all refrigerants are recovered safely.
- Prior to the task being carried out, an oil and refrigerant sample shall be taken in case analysis is required prior to re-use of reclaimed refrigerant.
- It is essential that electrical power is available before the task is commenced.

a) Become familiar with the equipment and its operation.

b) Isolate system electrically.

c) Before attempting the procedure ensure that:

- Mechanical handling equipment is available, if required, for handling refrigerant cylinders;
- All personal protective equipment is available and being used correctly;
- The recovery process is supervised at all times by a competent person;
- Recovery equipment and cylinders conform to the appropriate standards.

d) Pump down refrigerant system, if possible.

e) If a vacuum is not possible, make a manifold so that refrigerant can be removed from various parts of the system.

f) Make sure that cylinder is situated on the scales before recovery takes place.

g) Start the recovery machine and operate in accordance with manufacturer's instructions.

h) Do not overfill cylinders. (No more than 80 % volume liquid charge).

i) Do not exceed the maximum working pressure of the cylinder, even temporarily.

j) When the cylinders have been filled correctly and the process completed, make sure that the cylinders and the equipment are removed from site promptly and all isolation valves on the equipment are closed off.

k) Recovered refrigerant shall not be charged into another refrigeration system unless it has been cleaned and checked.

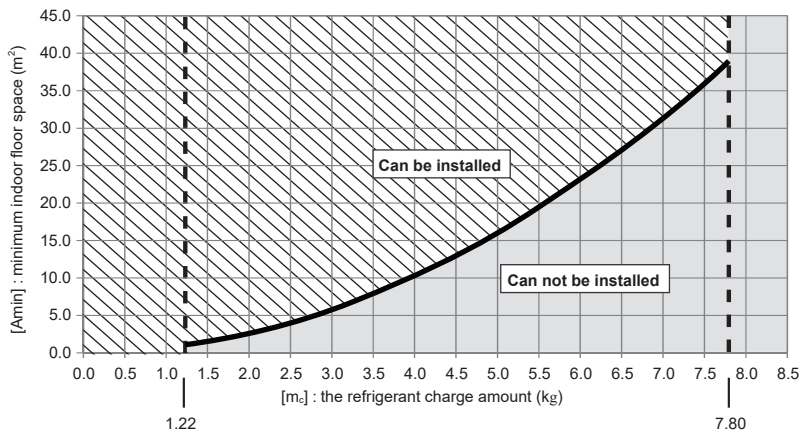
- Electrostatic charge may accumulate and create a hazardous condition when charging or discharging the refrigerant. To avoid fire or explosion, dissipate static electricity during transfer by grounding and bonding containers and equipment before charging/discharging.

<p>❗</p>	<p>11. Labelling</p> <ul style="list-style-type: none"> • Equipment shall be labelled stating that it has been de- commissioned and emptied of refrigerant. • The label shall be dated and signed. • Ensure that there are labels on the equipment stating the equipment contains flammable refrigerant.
<p>❗</p>	<p>12. Recovery</p> <ul style="list-style-type: none"> • When removing refrigerant from a system, either for servicing or decommissioning, it is recommended good practice that all refrigerants are removed safely. • When transferring refrigerant into cylinders, ensure that only appropriate refrigerant recovery cylinders are employed. • Ensure that the correct number of cylinders for holding the total system charge are available. • All cylinders to be used are designated for the recovered refrigerant and labelled for that refrigerant (i.e. special cylinders for the recovery of refrigerant). • Cylinders shall be complete with pressure-relief valve and associated shut-off valves in good working order. • Empty recovery cylinders are evacuated and, if possible, cooled before recovery occurs. • The recovery equipment shall be in good working order with a set of instructions concerning the equipment that is at hand and shall be suitable for the recovery of all appropriate refrigerants including, when applicable, flammable refrigerants. • In addition, a set of calibrated weighing scales shall be available and in good working order. • Hoses shall be complete with leak-free disconnect couplings and in good condition. • Before using the recovery machine, check that it is in satisfactory working order, has been properly maintained and that any associated electrical components are sealed to prevent ignition in the event of a refrigerant release. Consult manufacturer if in doubt. • The recovered refrigerant shall be returned to the refrigerant supplier in the correct recovery cylinder, and the relevant waste transfer note arranged. • Do not mix refrigerants in recovery units and especially not in cylinders. • If compressors or compressor oils are to be removed, ensure that they have been evacuated to an acceptable level to make certain that flammable refrigerant does not remain within the lubricant. • The evacuation process shall be carried out prior to returning the compressor to the suppliers. • Only electric heating to the compressor body shall be employed to accelerate this process. • When oil is drained from a system, it shall be carried out safely.

Check of Density Limit U-200PZH2E8, U-250PZH2E8

The refrigerant (R32), which is used in the air conditioner, is a flammable refrigerant. So the requirements for installation space of appliance are determined according to the refrigerant charge amount [m_c] used in the appliance.

The minimum indoor floor space compared with the amount of refrigerant is roughly as follows:



• 7.80 indicates m_{max} digit of the model U-200PZH2E8, U-250PZH2E8.

[m_c] : The refrigerant charge amount (Total of refrigerant at shipment and refrigerant charge amount in the field).

[m_{max}] : Maximum refrigerant charge amount

	U-200PZH2E8 U-250PZH2E8
m _{max}	7.80 kg






[m_c] ≤ 1.22 : Can be installed

1.22 < [m_c] ≤ [m_{max}] : Installation possible with in the range of slanted line part

[m_c] > [m_{max}] : Can not be installed

1. ACCESSORIES SUPPLIED WITH OUTDOOR UNIT

The following parts are supplied as accessories with each outdoor unit. Check that all accessory parts are present before installing the outdoor unit.

Part name	Diagram	Quantity	Part name	Diagram	Quantity
Joint tubing A (ø19.05 → ø25.4)		1	Protective bushing (for protecting electrical wires)		2
Joint tubing B (ø19.05)		1	Banding strap (for tying electrical wires together)		4
Operating Instructions		1	Installation Instructions	A1	1
				A2	1

! Please install according to “WARNING” or “CAUTION” on page 1-12-1-1-1 to 1-12-1-1-6.

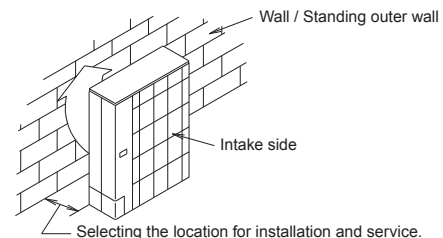
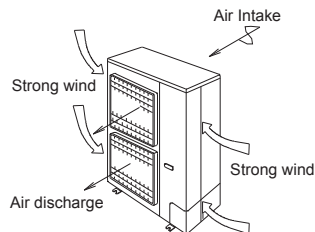
2. SELECT THE OUTDOOR UNIT INSTALLATION LOCATION



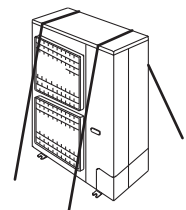
WARNING

Be careful when picking up and moving the indoor and outdoor units. Get a partner to help, and bend your knees when lifting to reduce strain on your back. Sharp edges or thin aluminum fins on the air conditioner can cut your fingers.

- Install the unit once you have checked that the installation location matches the following conditions.
 - A location with sufficient ventilation.
 - Possibly a location that is sheltered from rain or direct sunlight and is well-ventilated so that hot and cool air does not build up.
 - A location where the area around the discharge is not exposed to animals or plants which could adversely affect the release of hot or cool air from the unit.
 - A location where the discharge and operation noise will not be a nuisance to the neighbours.
 - A location that can support the product's weight or vibrations and secured for horizontal installation wherever possible.
 - A location that does not obstruct the air discharge or intake.
 - A location where there is no danger of flammable or corrosive gas leaks.
 - A location that provides space for installation and service.
 - A location that allows the tube and cable length fixture for internal and external connections.
 - It may need two or more people to carry out the installation work.
- Refer to the diagram below for the installation location which is exposed to strong wind.
 - If a strong wind of more than 5 m/sec blows to the area directly in front of the discharge, the outdoor unit's air flow is reduced and the outflow may re-enter (short circuit) causing the following outcome:
“Reduced capacity”, “Increased frost formation during heating” or “Operation stopped due to increased pressure”.
Should an exceptionally strong wind blow to the area directly in front of the discharge of the outdoor unit; there is the risk of damage due to the fan's high-speed reverse rotation.
 - If the direction of the prevailing wind is known when operating the unit, place the unit at an appropriate angle to the wind's direction so that the discharge faces towards a building or a wall.



- If installing at locations prone to snowfall, install the unit as high as possible with suitable roofing which shelters the unit from snow.
- Avoid installing the unit in locations where there are petroleum products (such as machine oil), saline content (such as coastal areas), sulphurous gas and where high frequency noise is generated.
- Place the indoor and outdoor unit, power cords and indoor/outdoor unit connection cables at a minimum distance of 1 meter or more away from televisions and radios. This is to avoid interference to picture and/or sound.
(However, depending on the electromagnetic waves, noise interference may still occur even with the 1 meter separation.)
- For restaurants and kitchens, avoid installing at locations which draws oil and steam.
Plastic parts can deteriorate from droplets of oil and steam or it can cause falling parts or water leakage.
- Avoid installing at the location where cutting oil mist or iron powder is present.
- If there is an immense voltage fluctuation due to the location's problem, ensure to split the power supply.
- When installing the product in a place where it will be affected by typhoon or strong wind such as wind blowing between buildings, including the rooftop of a building and a place where there is no building in surroundings, fix the product with an overturn prevention wire, etc.
- Ensure to assign several people or use a mechanical lift, etc. to transport the unit.

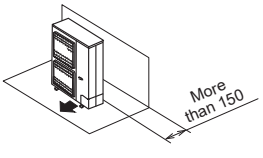


3. SELECTING THE LOCATION FOR INSTALLATION SERVICE

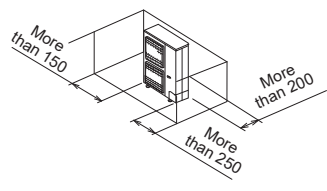
Please secure necessary space to guarantee performance and service & maintenance.
 For multiple installations, please secure enough space to enable removal of side face screws between units. (unit:mm)
 The below mentioned distance is required for optimal unit performance.
 Allow as much space as possible in order to obtain the best performance from the units.

(A) If there are obstacles at the intake

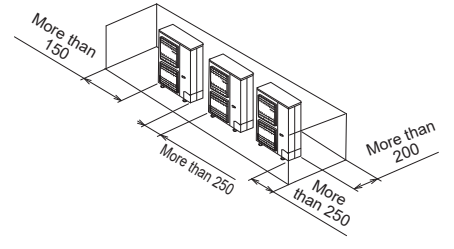
- If the upper part is open
 - (1) For separate installation location
 - Only if there are obstacles at the intake



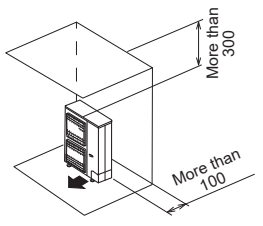
- If there are obstacles on both sides



- (2) For multiple units (more than 2 units)
 - If there are obstacles on both sides

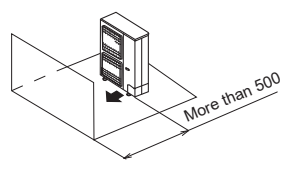


- If there are obstacles above the unit
 - (1) For separate installation location
 - Only if there are obstacles at the intake

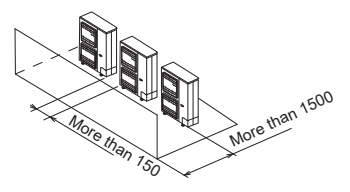


(B) If there are obstacles at the discharge

- If the upper part is open
 - (1) For separate installation location

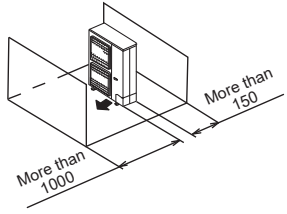


- (2) For multiple units (more than 2 units)

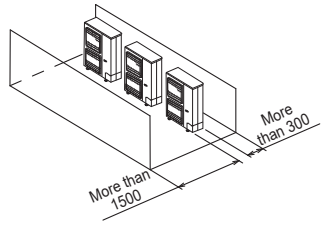


(C) If there are obstacles on both the intake and discharge
 If there is an obstacle that is higher than the unit on the intake side. (There is no limit to the height of the obstacle above the discharge.)

- If the upper part is open
 - (1) For separate installation location

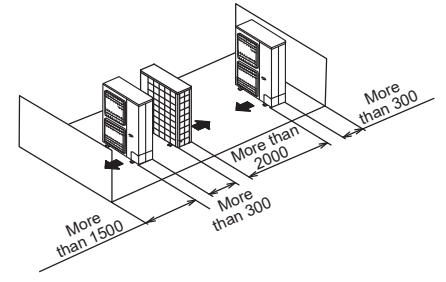


- (2) For multiple units (more than 2 units)




(D) For multiple row installation (on the roof, etc.)

- (1) For one row installation setup



4. TRANSPORT AND INSTALL THE OUTDOOR UNIT

- Transporting
 1. Transport the outdoor unit in its original packaging as close as possible to the installation location.
 2. In the event that the unit needs to be lifted or suspended, use a rope or belt and use cloth or wood as padding to avoid damaging the unit.
 3. Use the side handles to carry the unit and be careful not to touch the fan with your hand or any objects.
- Installation

 CAUTION	Route the tubing so that it does not contact the compressor, panel, or other parts inside the unit. Increased noise will result if the tubing contacts these parts.
	When routing the tubing, use a tube bender to bend the tubes.
	In cold-weather regions, in order to prevent drainage water from freezing, do not install the drain socket cap. Also take steps to prevent water from accumulating around the unit.

1. Read the "Select the outdoor unit installation location" thoroughly before installing the outdoor unit.
2. When installing to a concrete or solid surface, use M10 or a W 3/8 bolts and nuts to secure the unit. Ensure that it installed upright on a horizontal plane. (Use an anchor bolt for the installation as shown in the diagram below.)
3. Avoid installing on the slanted roof.
4. In the even where the roof is at risk of receiving oscillations or vibrations, secure the unit with a seismic isolating mount or vibration absorbing rubber.
5. The drain water will be discharged from the unit during heating or defrosting operation mode.

Select an appropriate location with good drainage system.

(In winter, there is a risk of slipping caused by freezing depending on the installation location.)

* Ensure a height of 15 cm or more at the feet on both sides of the unit.

* Precautions for Installation in Heavy Snow Areas.

The platform should be higher than the maximum snow depth + 50 cm.

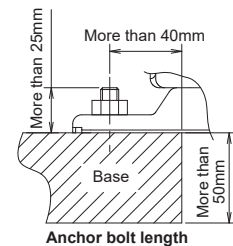
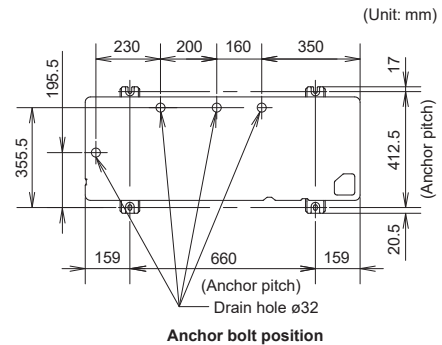
(In this case, leave clearance below the unit for the drain tube, and to prevent freezing of drainage water in cold-weather regions.)

* Please consult us if installing the drain socket (Field supply).

* When using a drain tube, install the drain socket (Field supply) onto the drain hole. Seal the other drain hole with the rubber cap (Field supply). For details, refer to the instruction manual of the drain socket (Field supply).

After completing the installation work of the drain socket, make sure that the water does not leak from any part of connection.

* In cold regions (where the outdoor temperature can drop to below 0° for 2 to 3 consecutive days), the drain water may freeze and may prevent the fan from operating. For this case, do not use the drain socket (Field supply).



5. REFRIGERANT INSTALLATION

For indoor unit refrigerant tubing installation, refer to the installation instruction manual that comes with that indoor unit. Do not reuse existing tubing, install new tubing.

1. Precautions during refrigerant installation.

- Use clean tubes with no dust inside.

The tube may corrode with the presence of fluorine dust which will adversely affect the refrigerant tubing system due to deterioration of the refrigerant oil, etc.

- This unit is specifically for R32. Ensure to adhere to the following items and install accordingly:

- Use tube cutters and flaring tools which are specially designed for use with R32.

- When connecting with flaring tools, coat the flare section with ether-based oil.

- Ensure to use flare nuts supplied with the unit when connecting this unit.

- Only for storing or for open tubes.

- Set the lower limit of the allowable tube length to 5m.

If the tube is shorter than 5m, the refrigerant may become overfilled and a problem such as abnormal high pressure could occur.

- Carefully handle the liquid refrigerant, as it may cause a frostbite.

- Do not release refrigerants during the tubing works for installing, re-installing and repairing refrigeration parts.

2. The local tubes can protrude from any four directions.

- Make holes in the tube panel for the tubes to penetrate it and lay the tubes accordingly.

- It is recommended to apply additional substance to the cut area for anti-rust protection.

- Ensure to install tube panels to prevent rain water from getting into the unit.

- Close the gap at the tube connected area with putty or heat insulator (field supply).

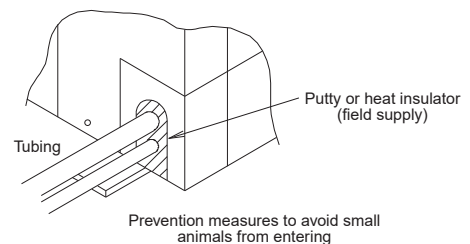
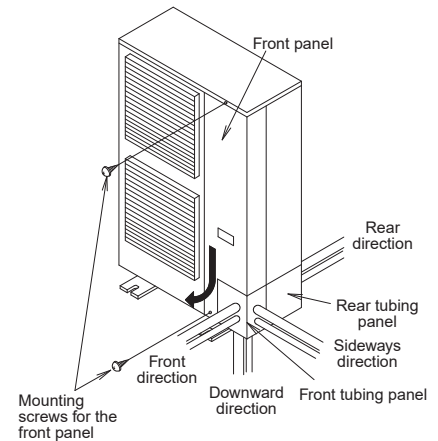
- If an insect or small animal enters the outdoor unit, there is the risk of shorting in the product electronic casing.

[Remove the front panel]

(1) Remove the 2 mounting screws.

(2) Slide the front panel using your hands downwards to release the pawls.

Then remove by pulling the panel towards you.



Specification for tube connecting indoor unit to outdoor unit

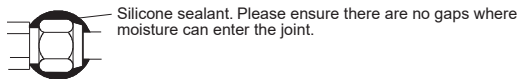
		U-200PZH2E8	U-250PZH2E8
Total tube length		100 m	80 m
Height difference	Outdoor located higher installation	30 m	
	Outdoor located lower installation	30 m	
Charge-less tube length		5-30 m	
Additional charge per 1 m		60 g/m	80 g/m
Refrigerant charged at shipment		4.2 kg	5.2 kg
Total refrigerant amount		7.80 kg	

		U-200PZH2E8	U-250PZH2E8
Valve size (Outdoor unit)	Liquid	ø9.52	ø12.7
	Gas	ø19.05 *	ø19.05 *
Main tube (Outdoor unit to Indoor unit)	Liquid	ø9.52	ø12.7
	Gas	ø25.4	ø25.4

* (Gas tubing connection) While the main gas tube is ø25.4, since connecting the outdoor unit's 3-way valve requires a ø19.05 flare, please be sure to use standard accessories joint tubing A for connection (brazing).

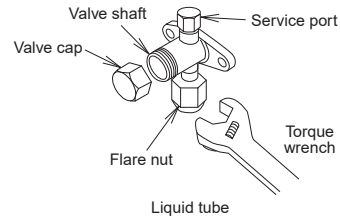
Precautions when operating the 3-way valve for tubing installation

- Do not open the 3-way valve until the tubing installation is completed.
 - It is closed during shipment.
 - During installation the side panel may warp if only the flare nut is loosened and tightened with a torque wrench. As a result, always be sure to secure to the hexagonal part of the 3-way valve with a spanner, or other tool.
- Refer to the following table for the tightening torque of the 3-way valve flare nuts.
 - If the nuts are over tightened, they may cause the flares to break or leak.
- Do not add additional force to the valve's cover.
 - Using spanners on the cover or valve itself (other than the hexagonal parts) may cause gas leakage. Avoid using spanners on the cover or parts other than the hexagonal part of the valve.
- When cooling in the low outdoor air, the low-pressure side pressure may decrease. Seal sufficiently the flare nut in the service valve (both gas and liquid tubes) with silicone sealant to avoid the gas leak caused by freezing.

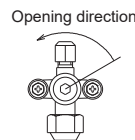
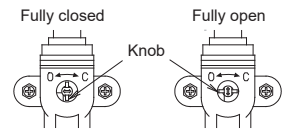
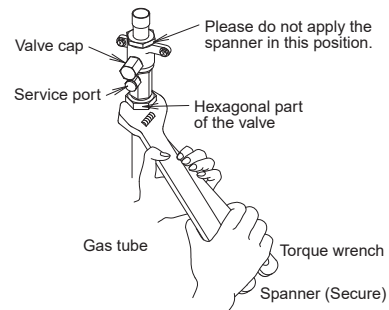


Silicone Sealant must be neutral cure and ammonia free. Use of silicon containing ammonia can lead to stress corrosion on the joint and cause leakage.

- Gas tube**
 Opening: Open the valve cap, pull out the knob and use pliers etc. to turn the knob 90° counter-clockwise.
 Closing: Open the valve cap, pull out the knob and use pliers etc. to turn the knob 90° clockwise.
- Liquid tube**
 Opening: Open the valve cap and turn the Allen wrench counter-clockwise until it stops.
 Closing: Open the valve cap and turn the Allen wrench clockwise until it stops.



(Please use a single, open-end spanner to loosen and tighten the liquid tube 3-way valve flare nut.)



CAUTION If the exterior of the outdoor unit valves has been finished with a square duct covering, make sure you allow sufficient space to access the valves and to allow the panels to be attached and removed.

After a tube has been insulated, never try to bend it into a narrow curve because it can cause the tube to break or crack. Never grasp the drain or refrigerant connecting outlets when moving the unit.

		Tightening torque (approx.)
Valve cap (Valve size)	ø9.52 (Liquid tube)	34 N•m~42 N•m {340 kgf•cm~420 kgf•cm}
	ø12.70 (Liquid tube)	49 N•m~55 N•m {490 kgf•cm~550 kgf•cm}
	ø19.05 (Gas tube)	100 N•m~120 N•m {1000 kgf•cm~1200 kgf•cm}
Service port		10.7N•m~14.7N•m {107 kgf•cm~147 kgf•cm}

Precautions for handling the valve cap

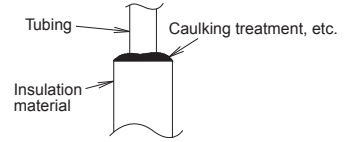
- Ensure not to scratch the inner surface of the valve or the end of the valve shaft.
- Once adjustments to the valve are completed, ensure to tighten the valve cap according to the prescribed torque.

Precautions for handling the service ports

- Use a push-rod with a charge hose.
- Once adjustments to the valve are completed, ensure to tighten the valve cap according to the prescribed torque.

Precautions for connecting the tubes

- For proper connection, align the union and flare straight with each other.
- Ensure that the tubes do not come into contact with the compressor's bolts or exterior panel.
- There is a risk of condensation from the 3-way valve coming out between the insulation material and the indoor unit's tubing when you install the outdoor unit above then the indoor unit. Ensure to caulk the connection parts.

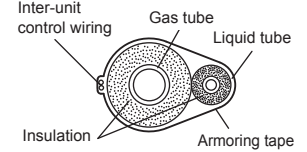


Precautions for insulation installation

Maximum temperature limit of gas or liquid tubing exceeds 120 °C

- In high humidity environment, reinforce the insulation material for the refrigerant tubing. Failure to do so may result in condensation on the surface of the insulation material.
- Use materials with good heat-resistant properties as the heat insulator for the tubes. Ensure to insulate both the gas and liquid tubes.
- If the tubes are not adequately insulated, condensation and water leakages may occur.
- Ensure that the current insulation covers the tubes up to the unit's connecting part.
- If the tubing is exposed, it may cause condensation or burn (when touch the tube).

Two tubes arranged together



Precautions for flare nut installation

Use of the Flaring Method

Many of conventional split system air conditioners employ the flaring method to connect refrigerant tubes that run between indoor and outdoor units. In this method, the copper tubes are flared at each end and connected with flare nuts.

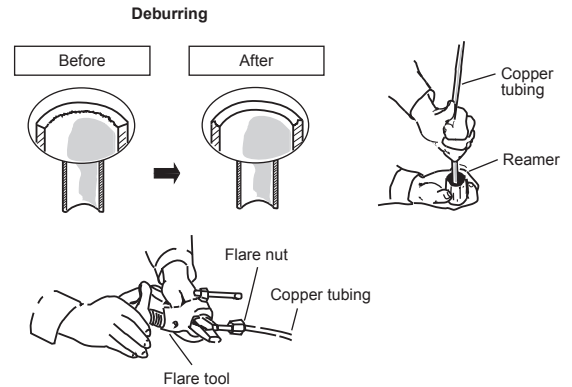
Flaring Procedure with a Flare Tool

- (1) Cut the copper tube to the required length with a tube cutter. It is recommended to cut approx. 30 – 50 cm longer than the tubing length you estimate.
- (2) Remove burrs at each end of the copper tubing with a tube reamer or a similar tool. This process is important and should be done carefully to make a good flare. Be sure to keep any contaminants (moisture, dirt, metal filings, etc.) from entering the tubing.

NOTE

When reaming, hold the tube end downward and be sure that no copper scraps fall into the tube.

- (3) Remove the flare nut from the unit and be sure to mount it on the copper tube.
- (4) Make a flare at the end of the copper tube with a flare tool.



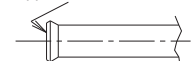
- Dimensions when adding flare nuts and the tightening torque
- For the flare nuts at tubing connections, be sure to use the flare nuts that were supplied with the unit. The refrigerant tubing that is used must be of the correct wall thickness as shown in the table below.

Tubing size	Tightening torque (approx.)	Flare section dimensions A	Tube thickness	Flare configuration
ø 6.35	14.0 N•m~18.0 N•m {140 kgf•cm~180 kgf•cm}	8.7 ~ 9.1 mm	0.8 mm	
ø 9.52	34.0 N•m~42.0 N•m {340 kgf•cm~420 kgf•cm}	12.8 ~ 13.2 mm	0.8 mm	
ø 12.7	49.0 N•m~55.0 N•m {490 kgf•cm~550 kgf•cm}	16.2 ~ 16.6 mm	0.8 mm	
ø 15.88	68.0 N•m~82.0 N•m {680 kgf•cm~820 kgf•cm}	19.3 ~ 19.7 mm	1.0 mm	
ø 19.05	100 N•m~120 N•m {1020 kgf•cm~1220 kgf•cm}	23.6 ~ 24.0 mm	1.2 mm	

After tubing connection has completed, ensure there is no gas leakage.

- Because the pressure is approximately 1.6 times higher than refrigerant R22 pressure, the use of flare nuts (type 1) or thin-walled tubes may result in tube rupture, injury, or asphyxiation caused by refrigerant leakage.
- When tightening the flare nut, coat the flares (inner surface only) with refrigerant oil on the flares. Firstly, screw in 3-4 turns by hand.
 - * Ensure not to get oil on the screw part.
 - Refrigerant oil used is ether-based.
- Once the tubing connections are completed, perform leakage inspection using nitrogen gas.
- When flared joints are reused, the flare part shall be re-fabricated.
- Selecting the location for installation service

Application for ether-based oil

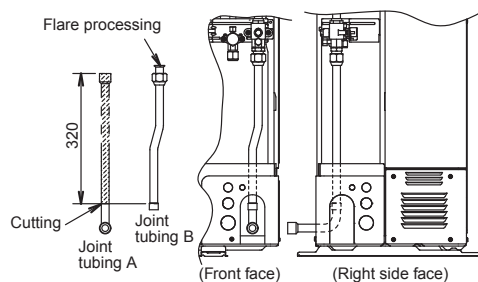


6. SELECTING THE LOCATION FOR INSTALLATION SERVICE

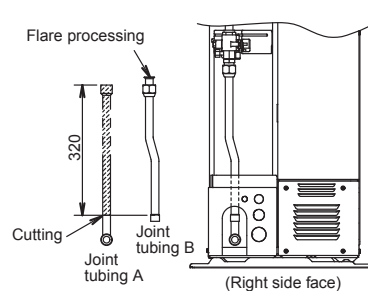
When installing multiple units, allow enough space in between the units and the side of the building.

Example of connecting tube process

(1) Front mounting

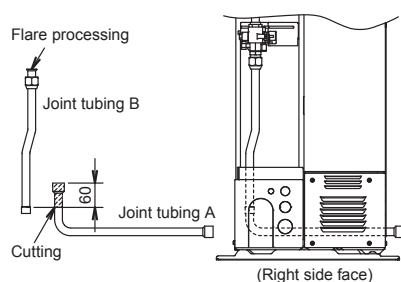


(2) Right mounting/flare processing

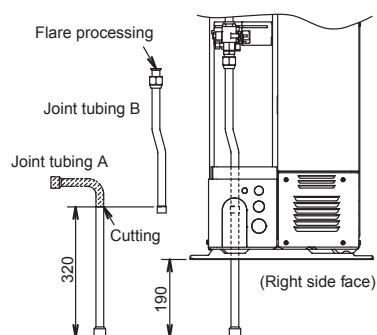


(Unit: mm)

(3) Rear mounting



(4) Bottom mounting



- (Gas tubing connection) While the main gas tube is $\varnothing 25.4$, since connecting the outdoor unit's 3-way valve requires a $\varnothing 19.05$ flare, please be sure to use standard accessories joint tubing B or A for connection (brazing), and connect as follows.
 1. Since standard accessory joint tubing B comes supplied for connecting the outdoor unit's 3-way valve, machine the upper edge to $\varnothing 19.05$ flare specifications.
 2. Refer to connection tube process examples (1) - (4) to cut the joint tubing A to the necessary length.
 3. Braze the machined (cut) joint tubing A to the bottom edge of joint tubing B.
 4. In order to protect wiring and parts in the unit, please carry out brazing outside the unit (since each type of joint tubing is differently oriented, carry out brazing according to the orientations shown in the connection tube process diagrams).
 5. Connect the brazed connection tubes to the outdoor unit's 3-way valve through the flare connection.
- When cutting the tube, use a tube cutter and be sure to carry out deburring.
- Ensure that water, sand etc. do not enter the interior of the tubing.
- Using a flare tool, carry out sound flare process.

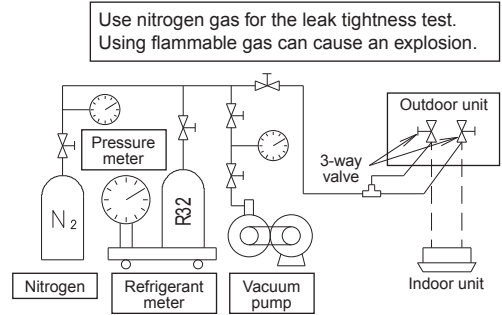
7. LEAK TEST AND EVACUATION

Leak Tightness Test Method

- Keep 3-way valve fully closed and pressurize through 3-way valve service port.
- Do not pressurize to the default value at once. Pressurize gradually.
 - (1) Pressurize to 0.5MPa {5 kgf/cm²G} and then leave it for 5 minutes to ensure that the pressure does not drop.
 - (2) Pressurize to 1.5MPa {15 kgf/cm²G} and leave it for 5 minutes to ensure that the pressure does not drop.
 - (3) For the test, pressurize to 4.15MPa and leave it for about 1 day to ensure that the pressure does not drop.

EVACUATION

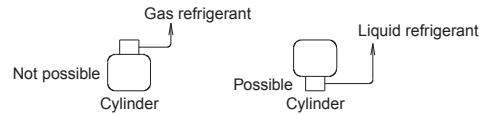
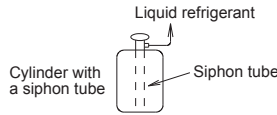
- Use a vacuum pump (with back-flow prevention device) to vacuum through the 3-way valve service port to achieve the pressure below -101kPa {-755 mmHg, 5 Torr}.
- Air and moisture remaining in the refrigerant system due to poor vacuum drying can cause performance decrement and malfunction of the compressor.



8. REGARDING REFRIGERANT FILLING

Precautions during refrigerant filling

- Ensure to fill only with liquid refrigerant when refilling. If gas refrigerant is filled, the refrigerant composition will not be balanced and will cause abnormal operation.
- If using cylinders as shown in the bottom left diagram; without a siphon tube inside, turn it upside down and use it. (It is recommended to use the manifold with the side glass.)



- Use tools that are designed specifically for R32, for pressure resistance and to prevent mixing impurities.
- Fill the refrigerant from the 3-way valve's service port on the liquid tube.

For filling and replacing all refrigerant (For refilling due to a leak)

- For refilling refrigerant, first collect all residual refrigerant and after vacuum dehydration using the vacuum pump. Refill the refrigerant according to the prescribed amount stated on the placard affixed to this unit.

Precautions after the tubes' connection have completed

- Ensure to open the 3-way valve after completing the tubing installation, leak test and vacuuming. If it is closed during operation, it can lead to compressor failure.

Charging with refrigerant * For single combination

- At the time of shipment from the factory, this unit is charged with enough refrigerant for an equivalent tube length of 30m. If the equivalent tube length used will be 30m or less, no additional charging will be necessary.
- If the equivalent tube length will be between 30 and 50/85m, charge with additional refrigerant according to the equivalent length given in the table below.
- For other combinations: Please refer to "9. TWIN, TRIPLE AND DOUBLE TWIN TYPE CONNECTIONS"

	Additional charging amount	Equivalent length	Minimum length
U-200PZH2E8	60 g/m	90 m	5 m
U-250PZH2E8	80 g/m	60 m	5 m

- Pump down operation
Please see Section 2 "2-12. Caution for Pump Down" on page 2-15.
It is also indicated on the label affixed to the outdoor unit.

9. TWIN, TRIPLE AND DOUBLE TWIN TYPE CONNECTIONS

- Two, three or four indoor units can be operated simultaneously with a single remote controller. Note that individual operation is not possible.
- Master unit and slave unit can be set automatically in twin and triple system. No address setting is necessary.
- Applicable "TWIN" and "TRIPLE" combination table.

	Outdoor unit	Type 200	Type 250
TWIN	combination		
TRIPLE	combination		/
DOUBLE TWIN	combination		

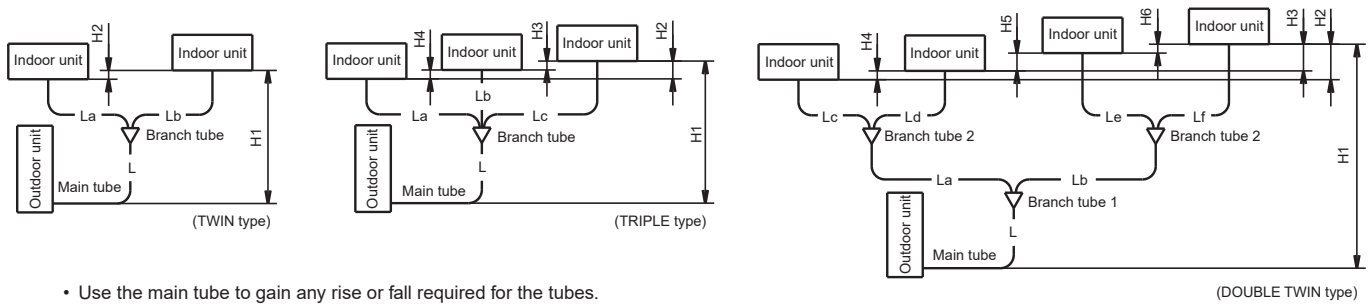
Tubing Connections

- The following table shows the tube diameter. (Branch tube kit should be used)

Outdoor unit main tube diameter (mm)	Branch tube diameter	Indoor unit combination				
		S-50	S-60	S-71	S-100	S-125
Liquid tube : $\phi 9.52$ (U-200) / $\phi 12.7$ (U-250)	Liquid tube	$\phi 6.35$	$\phi 9.52$	$\phi 9.52$	$\phi 9.52$	$\phi 9.52$
Gas tube : $\phi 25.4$	Gas tube	$\phi 12.7$	$\phi 15.88$	$\phi 15.88$	$\phi 15.88$	$\phi 15.88$
Branch tube kit (option)	TWIN	CZ-P680BK2				
	DOUBLE TWIN	Branch tube 1:CZ-P680BK2 + Branch tube 2:CZ-P155BK1				
	TRIPLE	CZ-P3HPC2				

- The following table shows the equivalent tube lengths and height differences.

	SYMBOLS			SPEC	
	TWIN	TRIPLE	DOUBLE TWIN		
Total tube length	$L+La+Lb$	$L+La+Lb+Lc$	$L+La+Lb+Lc+Ld+Le+Lf$	100m (U-200) 80m (U-250)	
Maximum branch tube length	La or Lb	La or Lb or Lc	$La+Lc$ or $La+Ld$ or $Lb+Le$ or $Lb+Lf$	Less than 20m	
Maximum branch tube length difference	$La > Lb$ $La - Lb$	$La > Lb > Lc$ $La - Lb$ $Lb - Lc$ $La - Lc$	$Lb+Lf \rightarrow \text{MAX}$ $La+Lc \rightarrow \text{MIN}$ $(Lb + Lf) - (La + Lc)$	Less than 10m	
Maximum tube length difference of branch tube 1 (DOUBLE TWIN)	—	—	$Lb > La$ $Lb - La$	Less than 10m	
Maximum tube length difference of branch tube 2 (DOUBLE TWIN)	—	—	$Ld > Lc$ $Lf > Le$ $Ld - Lc$ $Lf - Le$	Less than 10m	
Height difference	Outdoor located higher installation			H1	Less than 30m
	Outdoor located lower installation			H1	Less than 30m
Height difference between indoor units	H2	H2 or H3 or H4	H2 or H3 or H4 or H5 or H6 or H7	Less than 0.5m	



- Use the main tube to gain any rise or fall required for the tubes.
- The number of bends should be 8 or less in a single system, and 15 or less overall.
- Branch tubes should be positioned horizontally.

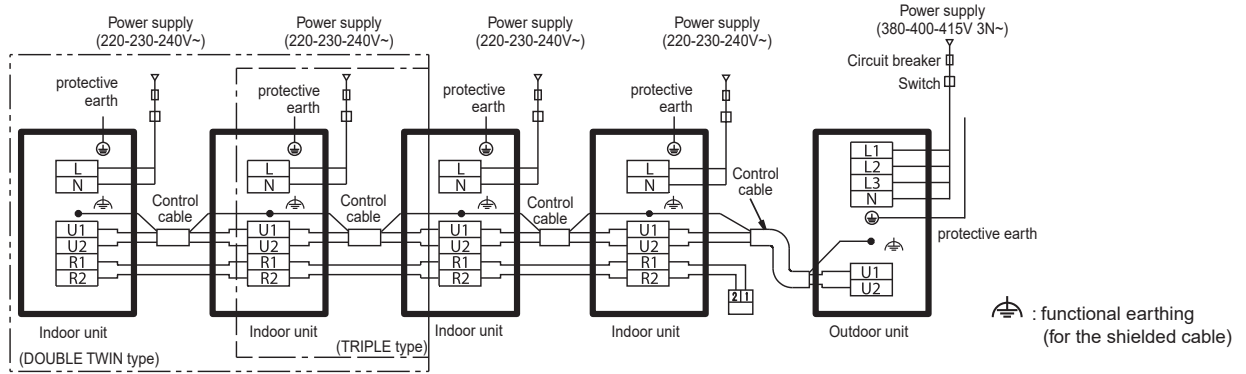
Refrigerant charging

Addition amount of refrigerant [g/m]

		Tube diameter	Main tube	Branch tube		
			L	La, Lb	La, Lb, Lc	Lc, Ld, Le, Lf
U-200PZH2E8	TWIN	Liquid tube : \varnothing 9.52 Gas tube : \varnothing 25.4	60	45	-	-
	TRIPLE		60	-	45	-
	DOUBLE TWIN		60	45	-	20
U-250PZH2E8	TWIN	Liquid tube : \varnothing 12.7 Gas tube : \varnothing 25.4	80	45	-	-
	DOUBLE TWIN		80	45	-	45

- Make additional charges by adding up tube length in an order of main tube (L) → branch tube (La → Lb → Lc wide diameter) and then selecting the amount of refrigerant corresponding to the remaining (after 30m for the twin connection and after 20m for the triple/double-twin connections) liquid tube diameter and tube length from the table above.

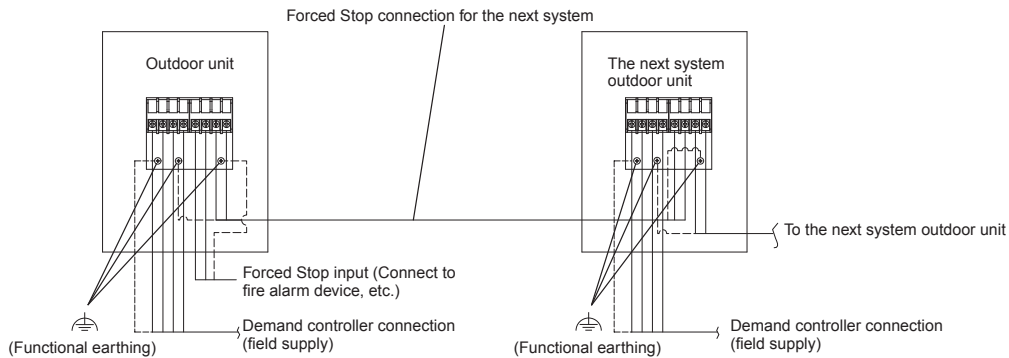
Wiring



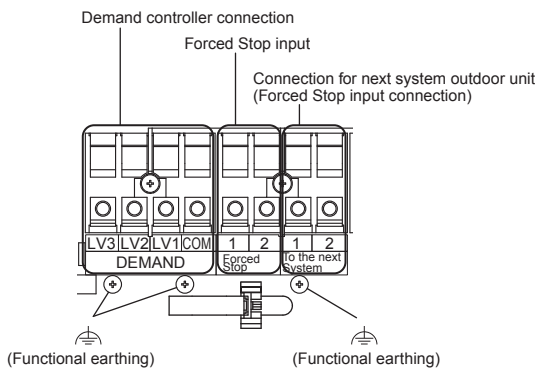
CONNECTION FOR DEMAND AND FORCED STOP

1. CONNECTION PROCEDURE

Be sure to always turn the power off first when setting up the wire and cable connections. Failure to do so may lead to electric shock or unit failure.

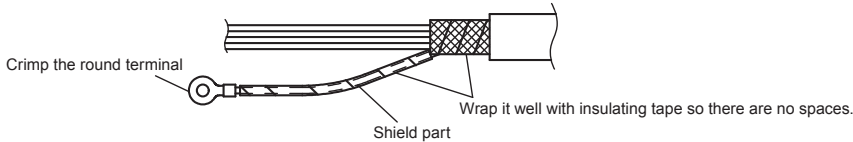


The demand terminal set up is shown in the following illustration.



- Use a shielded cable for the cable connection.

For the shield part of the shielded cable twist the end out, crimp it with a round terminal, and connect it to the functional earthing screw. After crimping it with a round terminal, wrap it with insulating tape so there are no spaces and adjust it so the shield part does not touch any live parts.

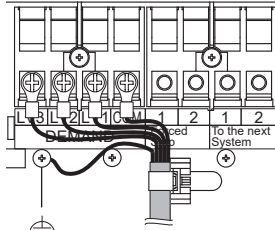


CAUTION Be sure that the shield part of the shielded cable does not touch the terminal block or any live parts. Failure to do so may lead to electric shock or fire.

WHEN CONNECTING THE DEMAND CONTROLLER INPUT

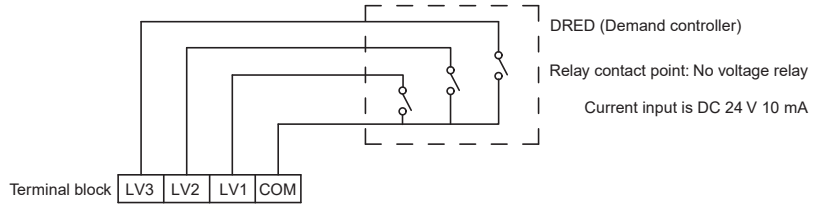
It is possible to choose various demand levels. See the table shown on the right.

Terminal no. for demand section	Description
LV1	Approx. 75% of rated power input
LV2	Approx. 50% of rated power input
LV3	Compressor off



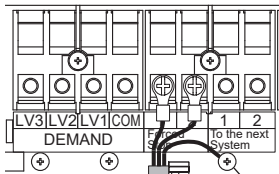
(Functional earthing)

Connect the wiring (4-wire) to the Demand section (LV1, LV2, LV3, COM) on the terminal block. The shield part of the shielded cable is connected with (functional earthing) under the terminal block. Secure the wiring with the cord clamp located on the lower part of the terminal block.



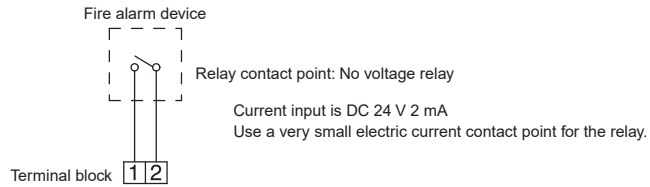
WHEN CONNECTION TO THE FORCED STOP INPUT

With the Forced Stop input, it is possible to override the air conditioning operation to force a stop if a signal is received from a fire alarm device, etc.



(Functional earthing)

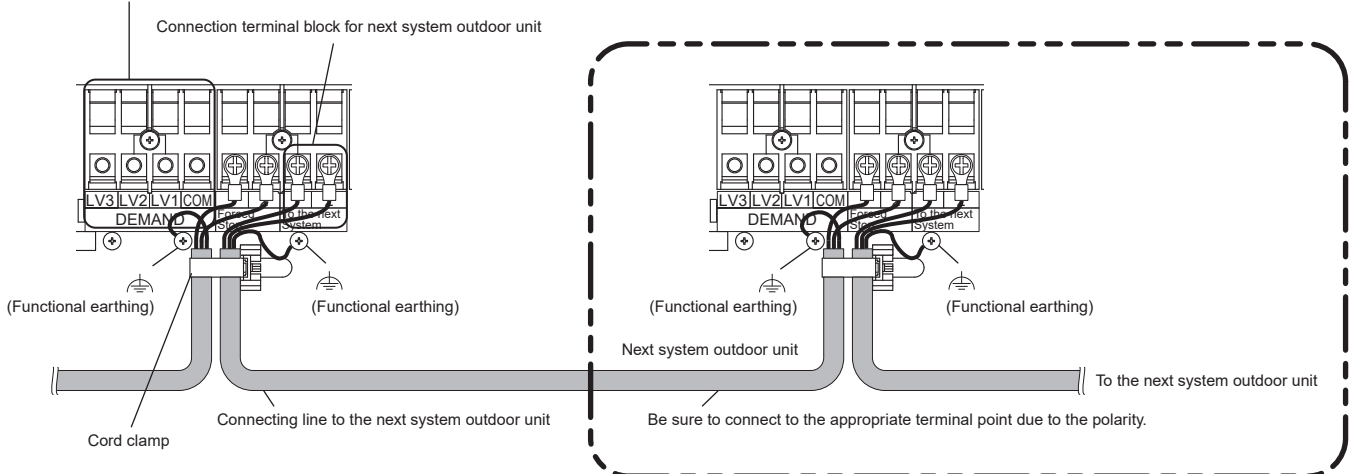
Connect the wiring (2-wire) to points 1 and 2 on the left side of the terminal block. The shield part of the shielded cable is connected with (functional earthing) under the terminal block. Secure the wiring with the cord clamp located on the lower part of the terminal block.



WHEN CONNECTING TO THE NEXT SYSTEM UNIT

- Forced Stop input can be transferred to the next system unit.
 - When using the Forced Stop input, connect the wiring to the terminal points 1 and 2 on the right side of the lower part of the terminal block.
 - The maximum wire/cable length is 100 m.
 - The demand control cannot be transferred to the next system unit.
 - When transferring to the next system, the maximum number of connecting units is 30.
1. Connecting the wiring to the lower part of the terminal block.
When transferring the Forced Stop input to the next system connect the wiring (2-wire) to the terminal points 1 and 2 at the lower right side of the terminal block. The shield part of the shielded cable is connected with (functional earthing) under the terminal block. Secure the wiring with the cord clamp located on the lower part of the terminal block.
 2. Connecting the shielded cable to the terminal block for the next system.
For the Forced Stop input, connect the wiring to the terminal points 1 and 2 at the lower right side of the terminal block. When connecting to the next system be sure to connect to the appropriate terminal point due to the polarity.

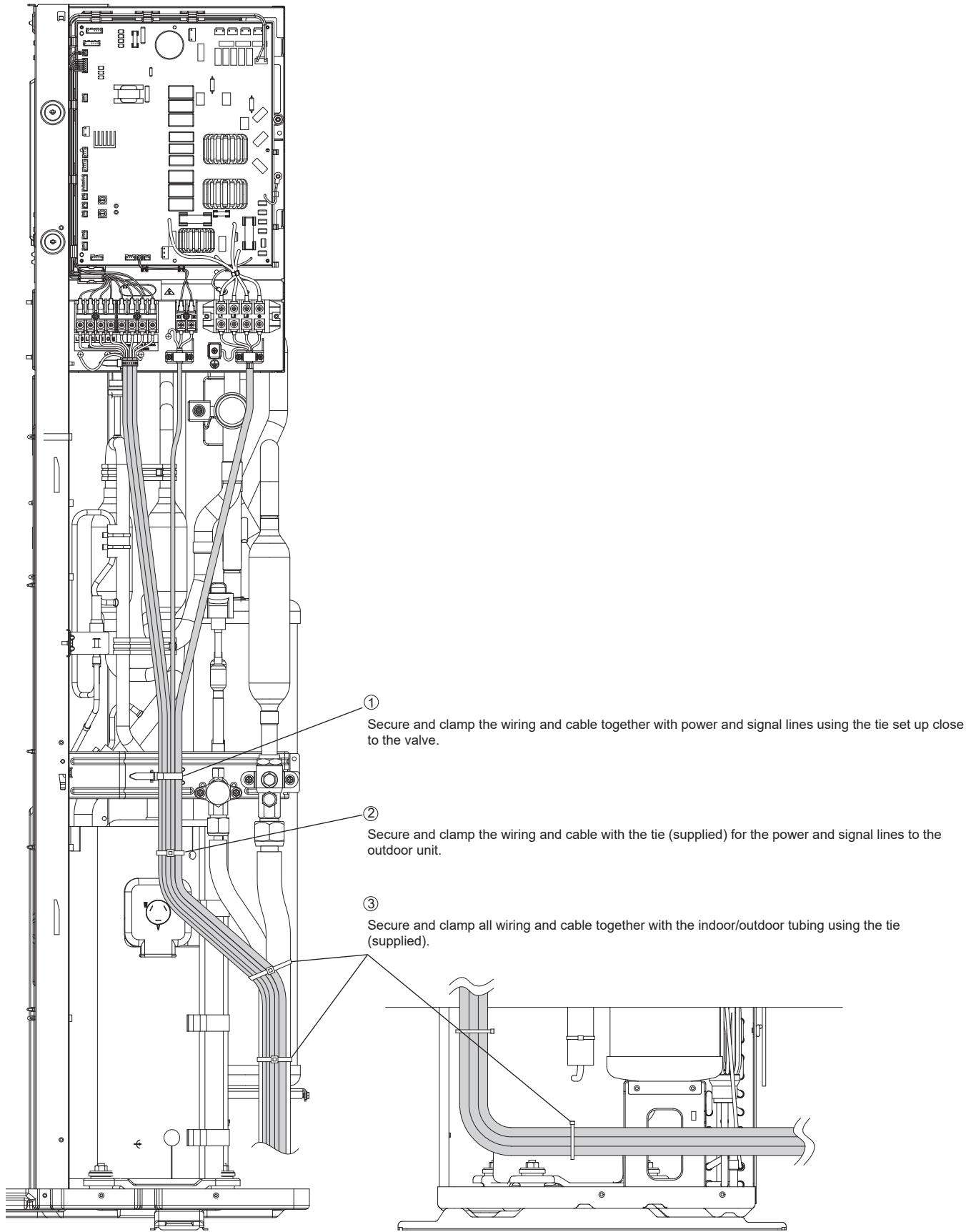
Demand control cannot be transferred to the next system



2. WIRING PROCEDURE

Follow the wiring procedure below for terminal connection.

- (1) Secure and clamp the power and signal lines with the tie, set up close to the valve.
- (2) Set the wiring and cables for the power and signal lines to the outdoor unit together, and secure each wire and cable with the tie.
- (3) Set up the wiring and cable for the outdoor unit tubing and secure with a tie.

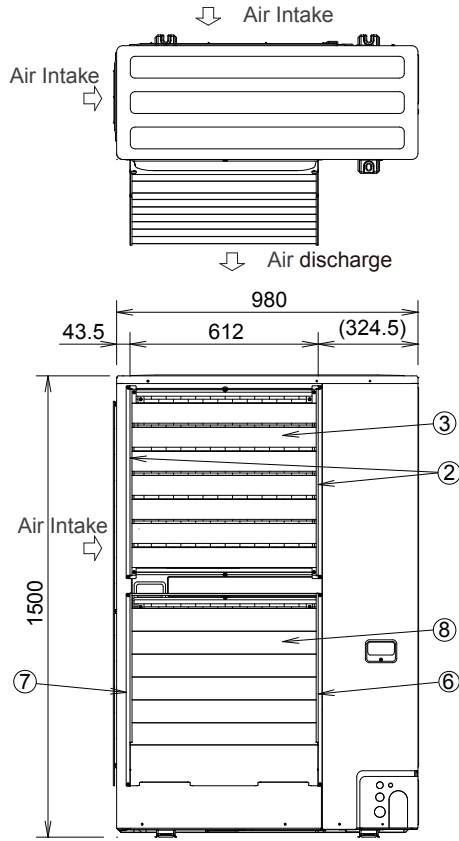


Supplement

1. Dimensions of Air-Discharge Chamber

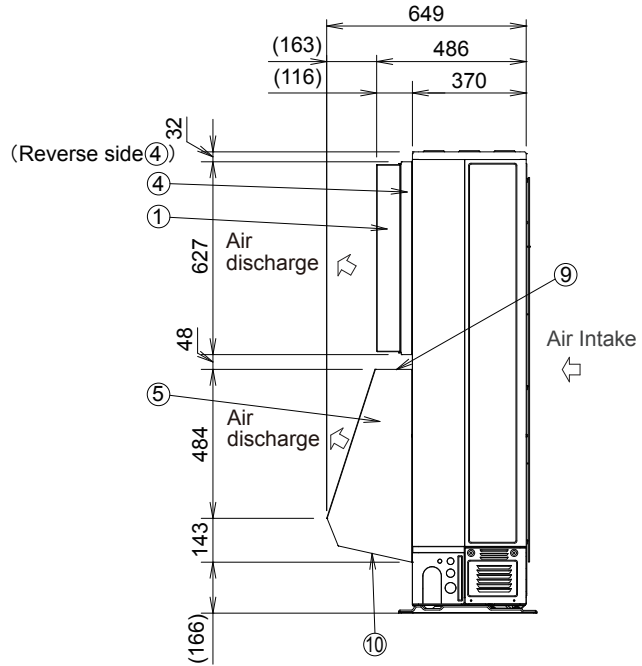
In snowy regions, if there is concern that snow may enter the air discharge chamber, remove the base of the chamber before using.

Reference diagram

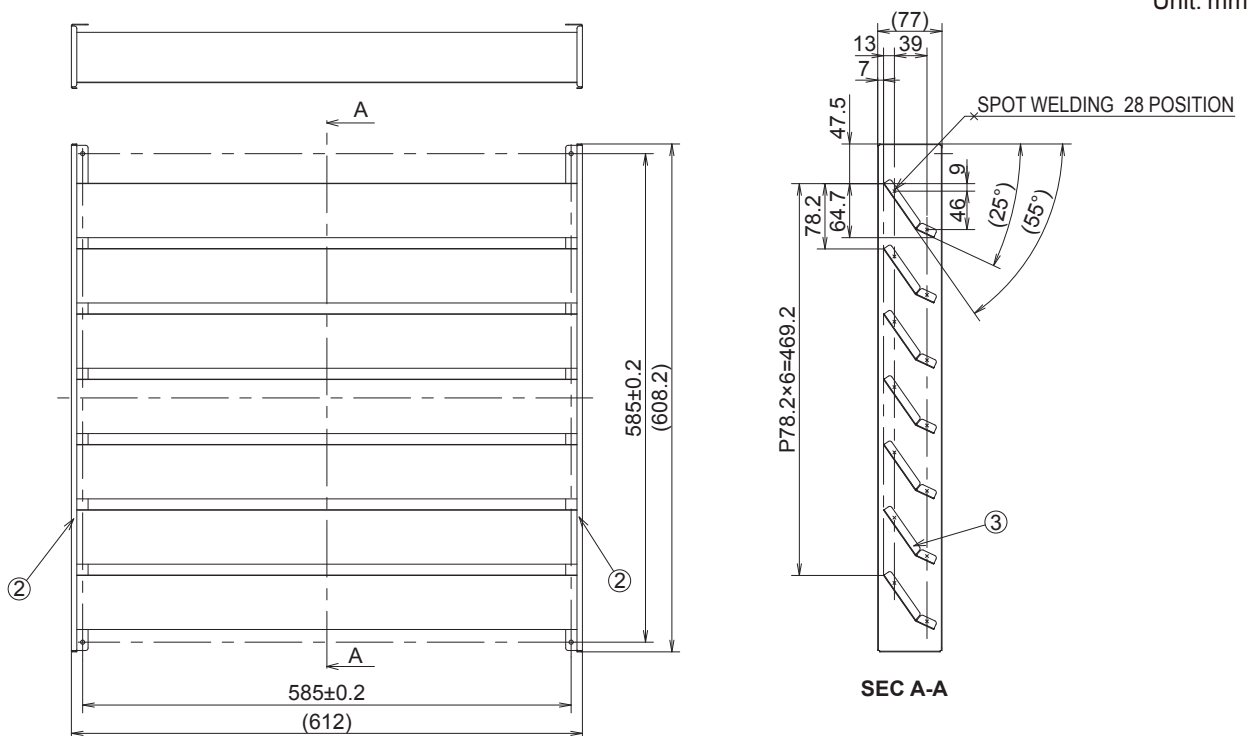


Callout	Description	Q'ty
①	Upward, Air-discharge support	1
①-②	Upward, side installation fixture	t0.8 2
①-③	Upward, Louver	t0.8 7
④	Upward, Louver installation guide	t1.0 2
⑤	Downward, Air-discharge support	1
⑤-⑥	Downward, Right side installation fixture	t0.8 1
⑤-⑦	Downward, Left side installation fixture	t0.8 1
⑤-⑧	Downward, Louver	t0.8 6
⑤-⑨	Downward, Upward installation fixture	t0.8 1
⑤-⑩	Downward, Downward installation fixture	t0.8 1
⑪	Tapping Screw (4mm x 12mm)	12

Unit: mm



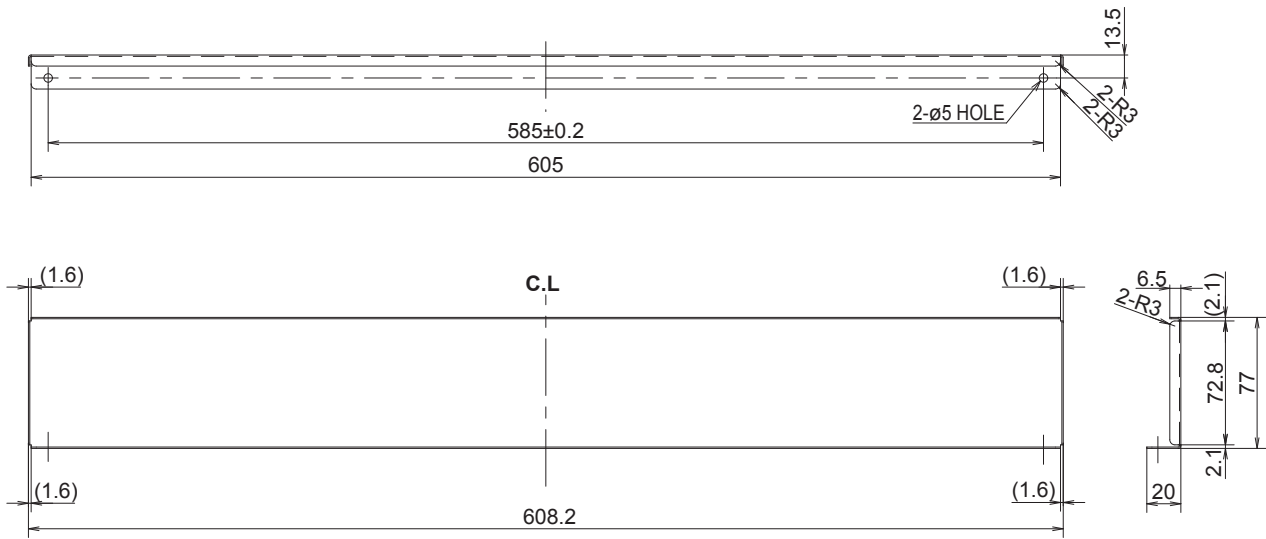
① Reference diagram for Upward Air-discharge support (field supply)



Unit: mm

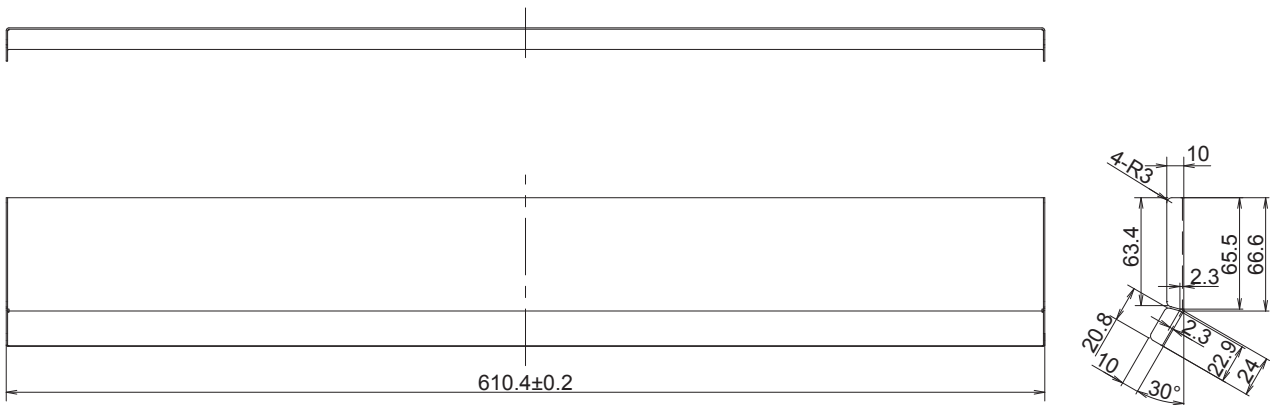
② Reference diagram for Upward, side installation fixture (field supply)

Unit: mm



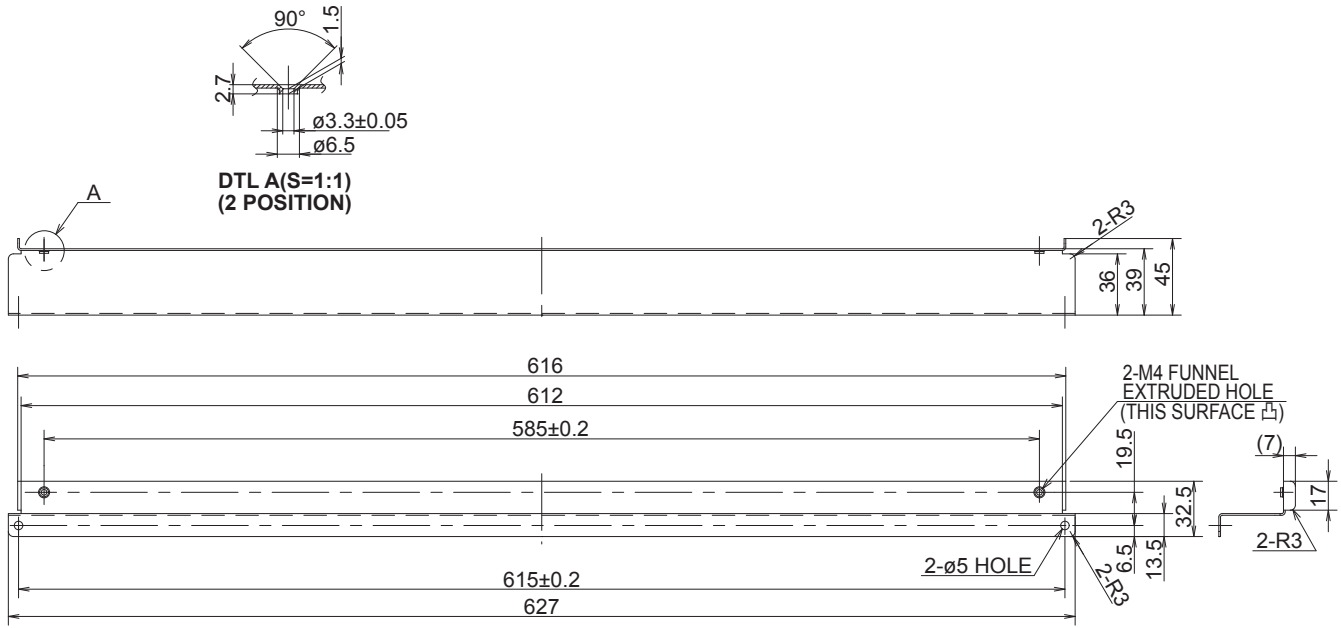
③ Reference diagram for Upward, Louver (field supply)

Unit: mm



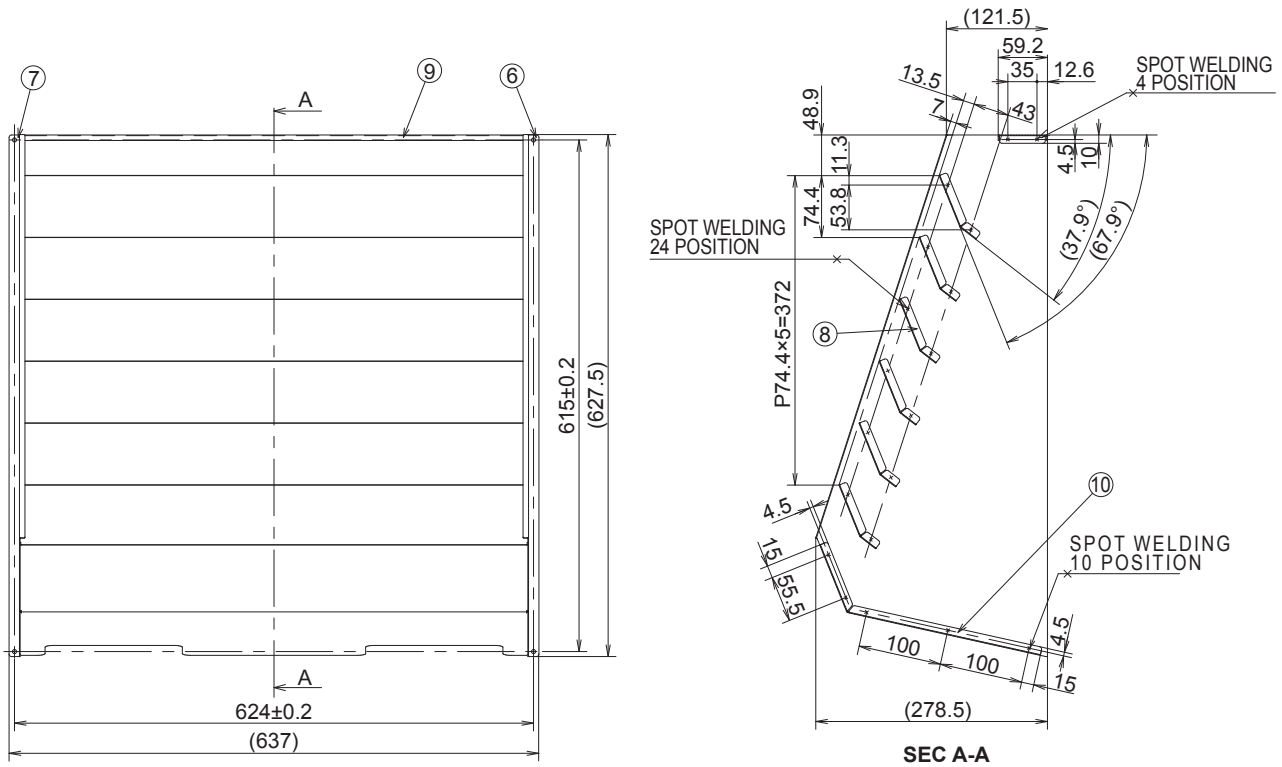
④ Reference diagram for Upward, Louver installation guide (field supply)

Unit: mm



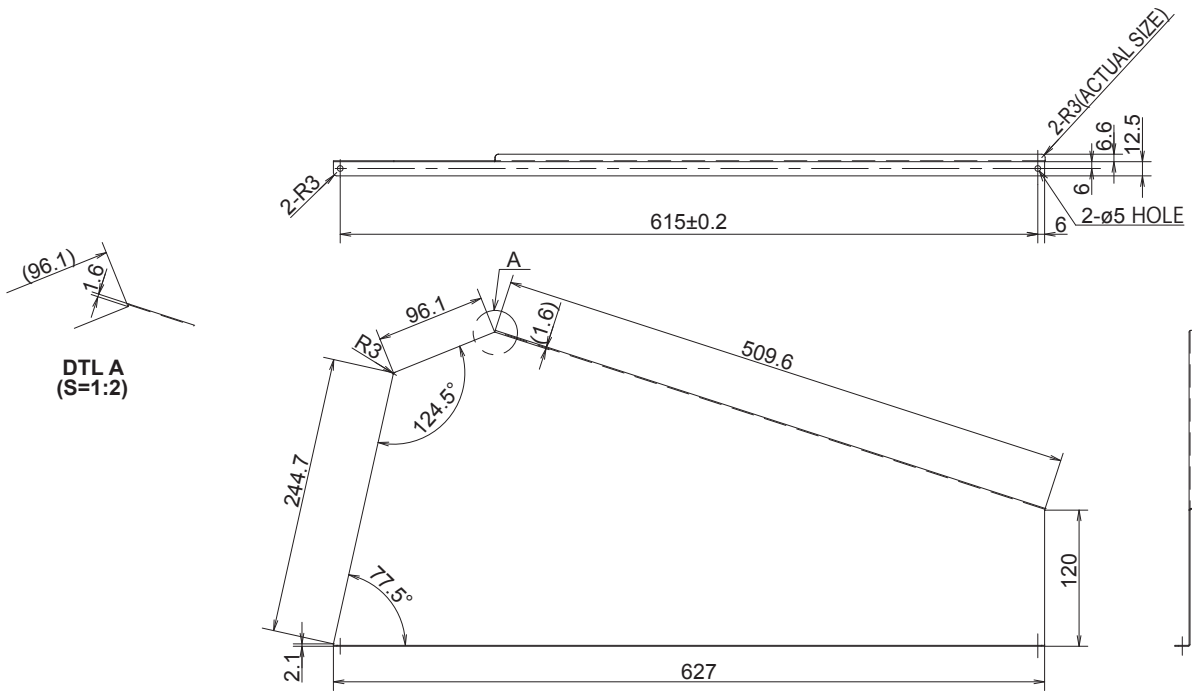
⑤ Reference diagram for Downward, Air-discharge support (field supply)

Unit: mm



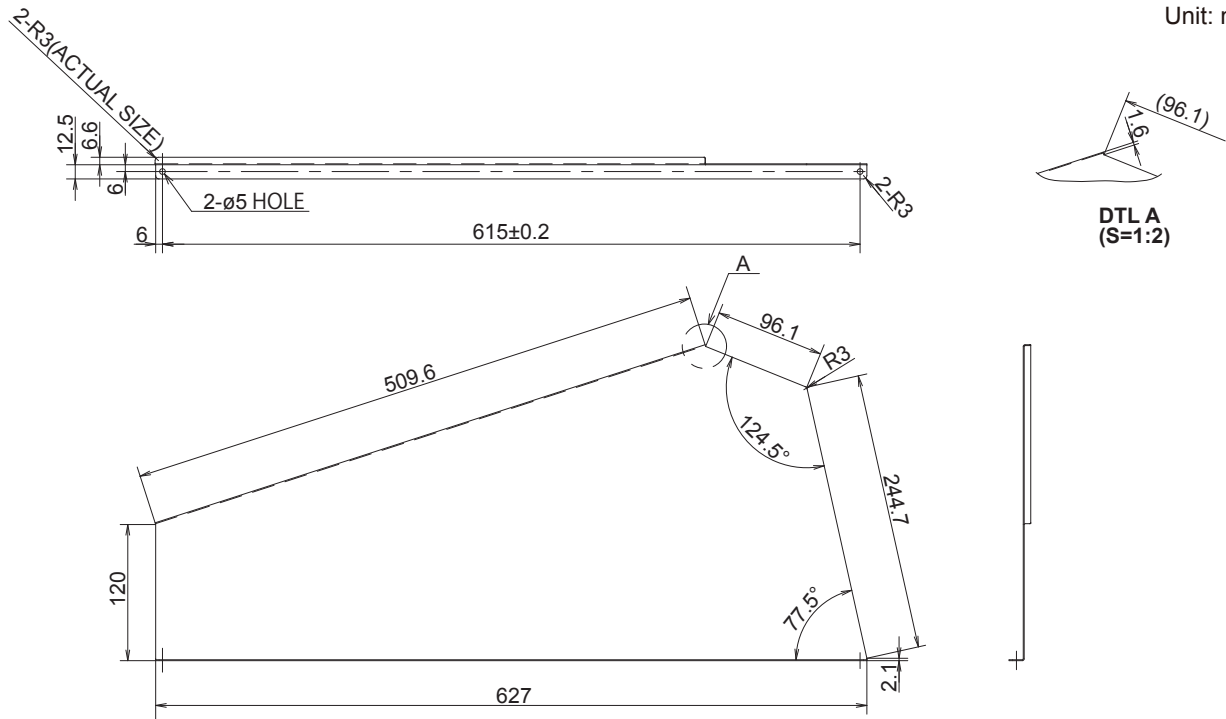
⑥ Reference diagram for Downward, Right side installation fixture (field supply)

Unit: mm



⑦ Reference diagram for Downward, Left side installation fixture (field supply)

Unit: mm



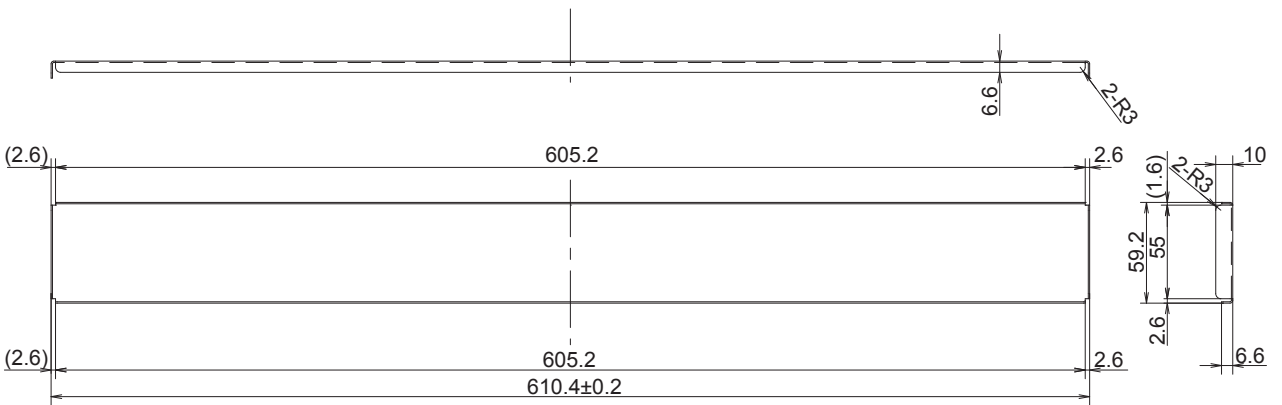
⑧ Reference diagram for Downward, Louver (field supply)

Unit: mm



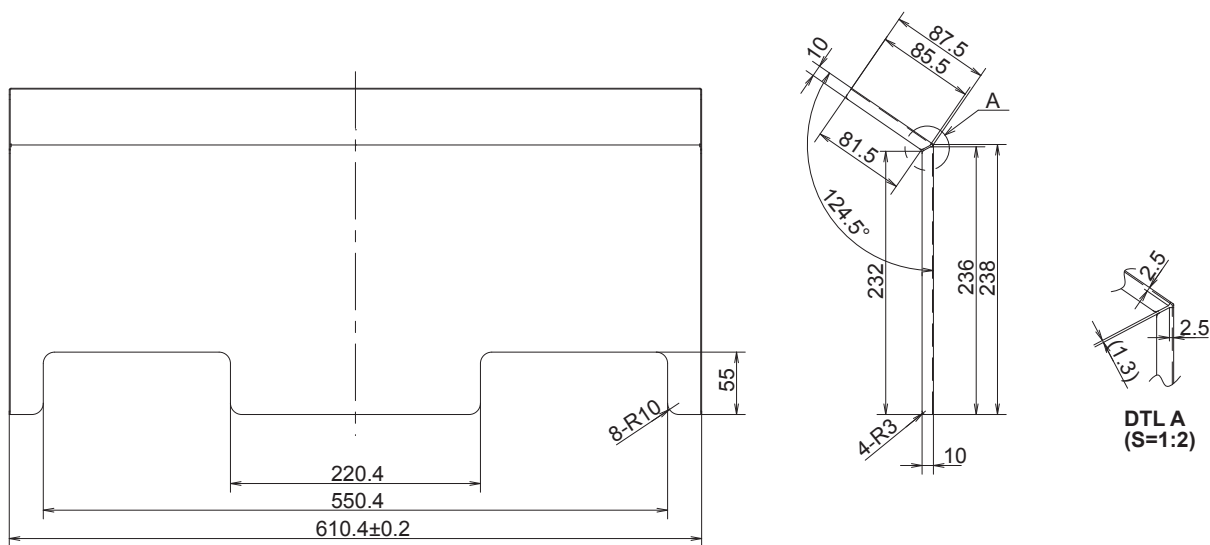
⑨ Reference diagram for Downward, Upward installation fixture (field supply)

Unit: mm



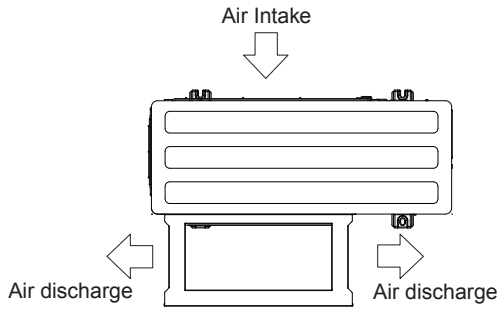
⑩ Reference diagram for Downward, Downward installation fixture (field supply)

Unit: mm

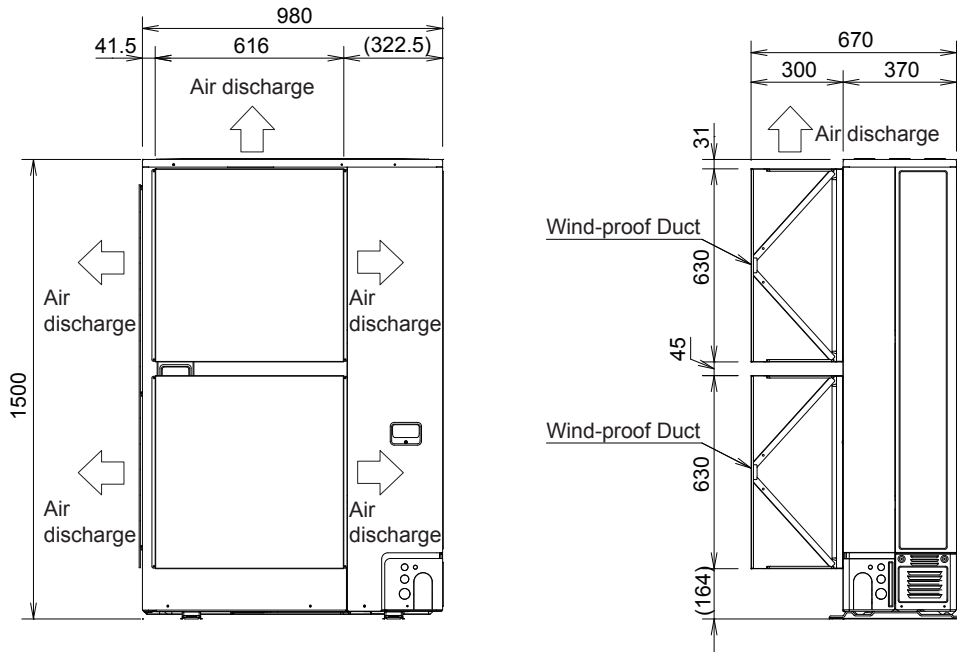


2. Dimensions of Wind-proof Duct

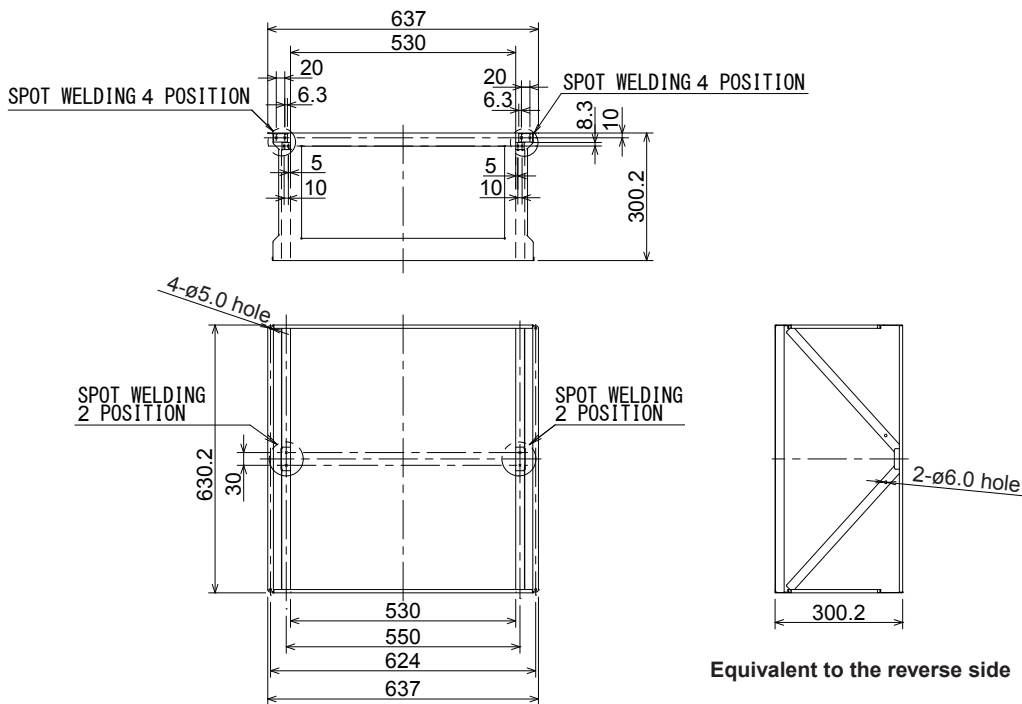
Reference diagram



Unit: mm



Reference diagram for wind-proof duct (field supply)



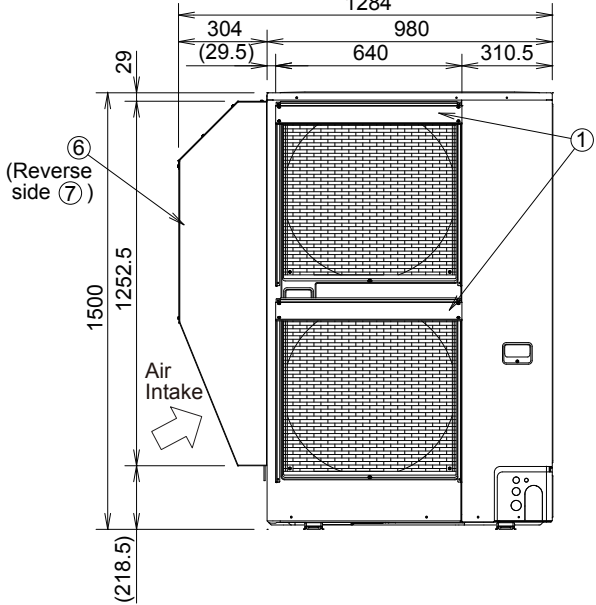
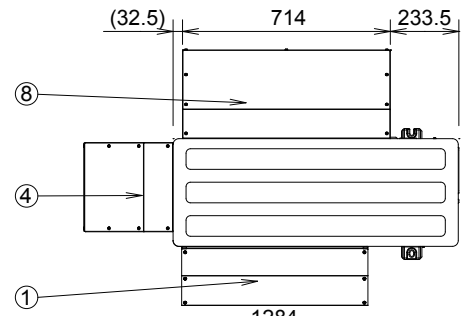
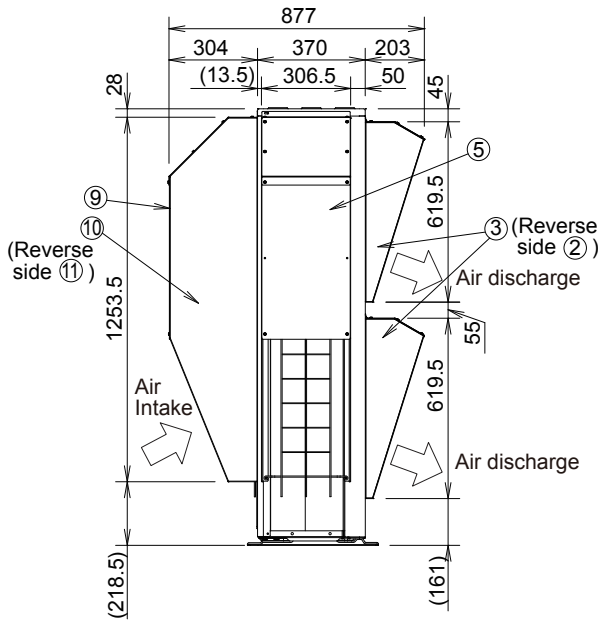
Unit: mm

3. Dimensions of Snow-proof Vents

Reference diagram

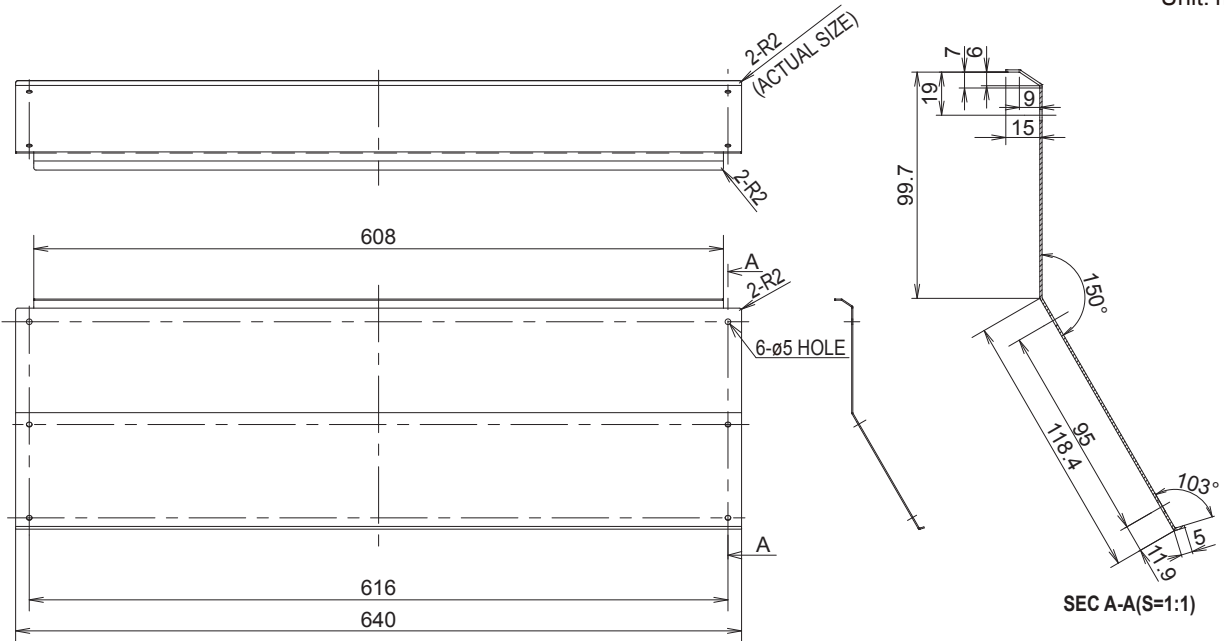
		Q'ty
①	Air-discharge Top side	t 1.0 2
②	Air-discharge Right side	t 1.0 2
③	Air-discharge Left side	t 1.0 2
④	Snow-proof Top side 1	t 1.0 1
⑤	Snow-proof Rear side 1	t 1.0 1
⑥	Snow-proof Right side 1	t 1.0 1
⑦	Snow-proof Left side 1	t 1.0 1
⑧	Snow-proof Top side 2	t 1.0 1
⑨	Snow-proof Rear side 2	t 1.0 1
⑩	Snow-proof Right side 2	t 1.0 1
⑪	Snow-proof Left side 2	t 1.0 1
⑫	Packing	t 5 2
⑬	Tapping screw (4x12)	57

Unit: mm



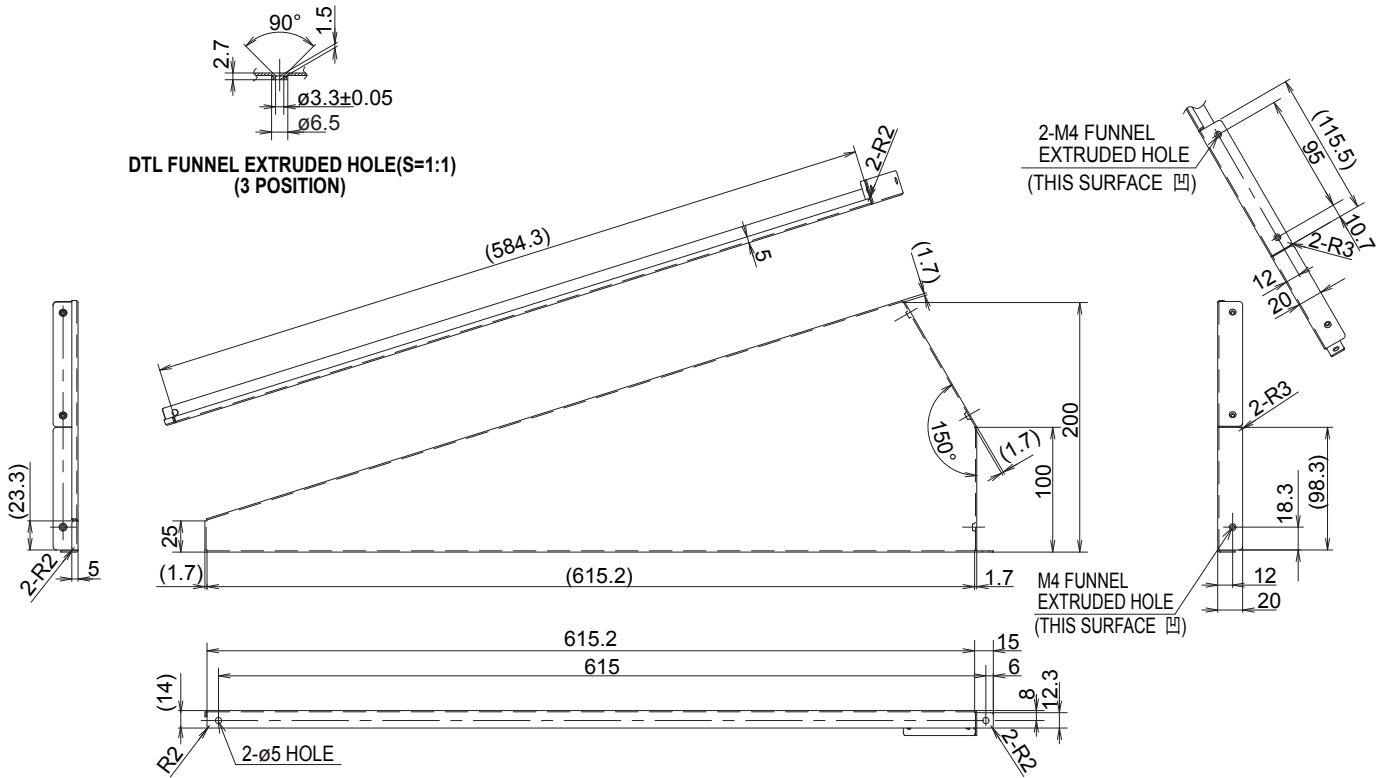
① Reference diagram for Air-discharge Top side (field supply)

Unit: mm



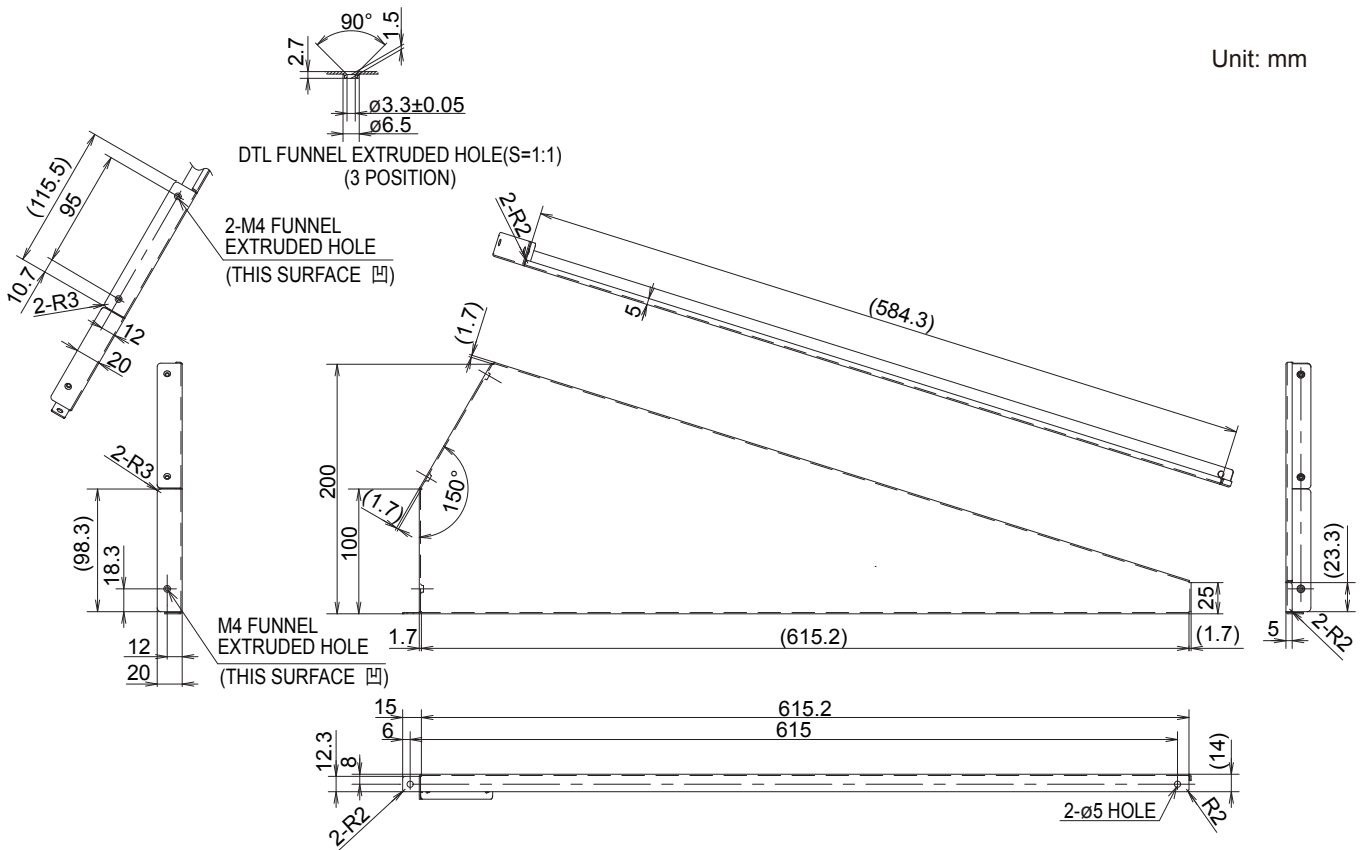
② Reference diagram for Air-discharge Right side (field supply)

Unit: mm



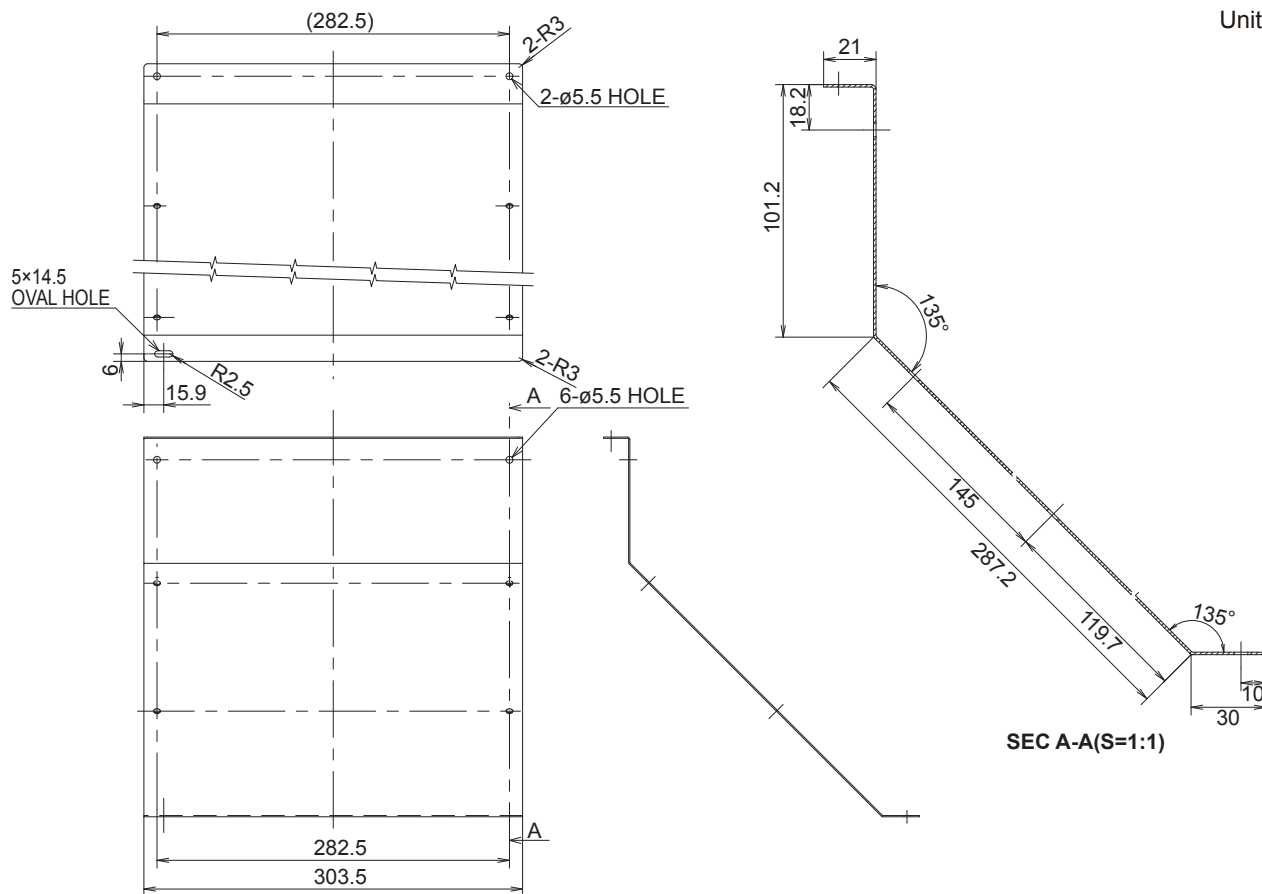
③ Reference diagram for Air-discharge Left side (field supply)

Unit: mm



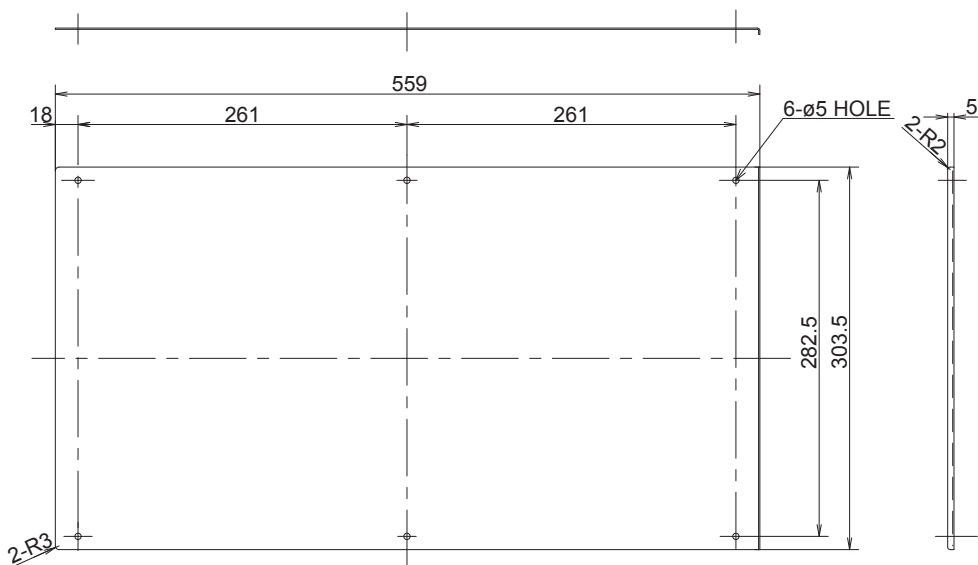
④ Reference diagram for Snow-proof Top side 1 (field supply)

Unit: mm



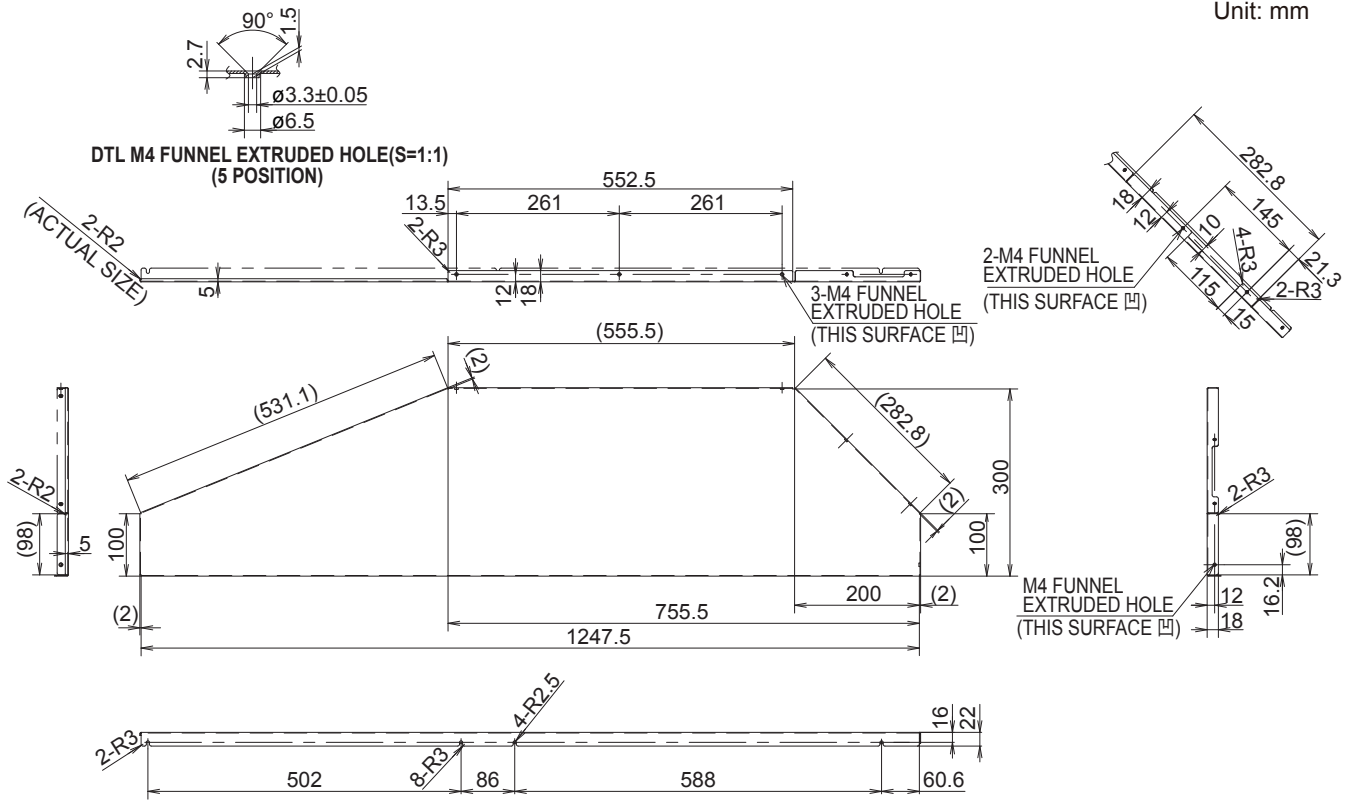
⑤ Reference diagram for Snow-proof Rear side 1 (field supply)

Unit: mm



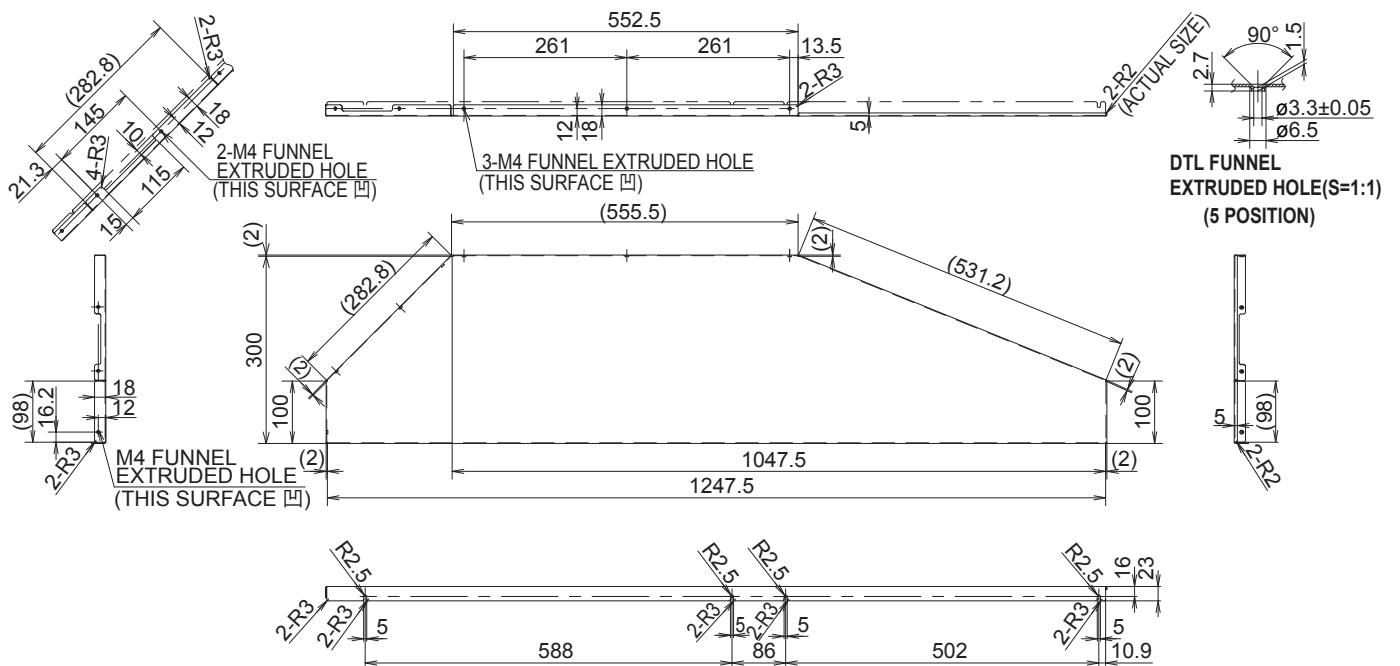
⑥ Reference diagram for Snow-proof Right side 1 (field supply)

Unit: mm



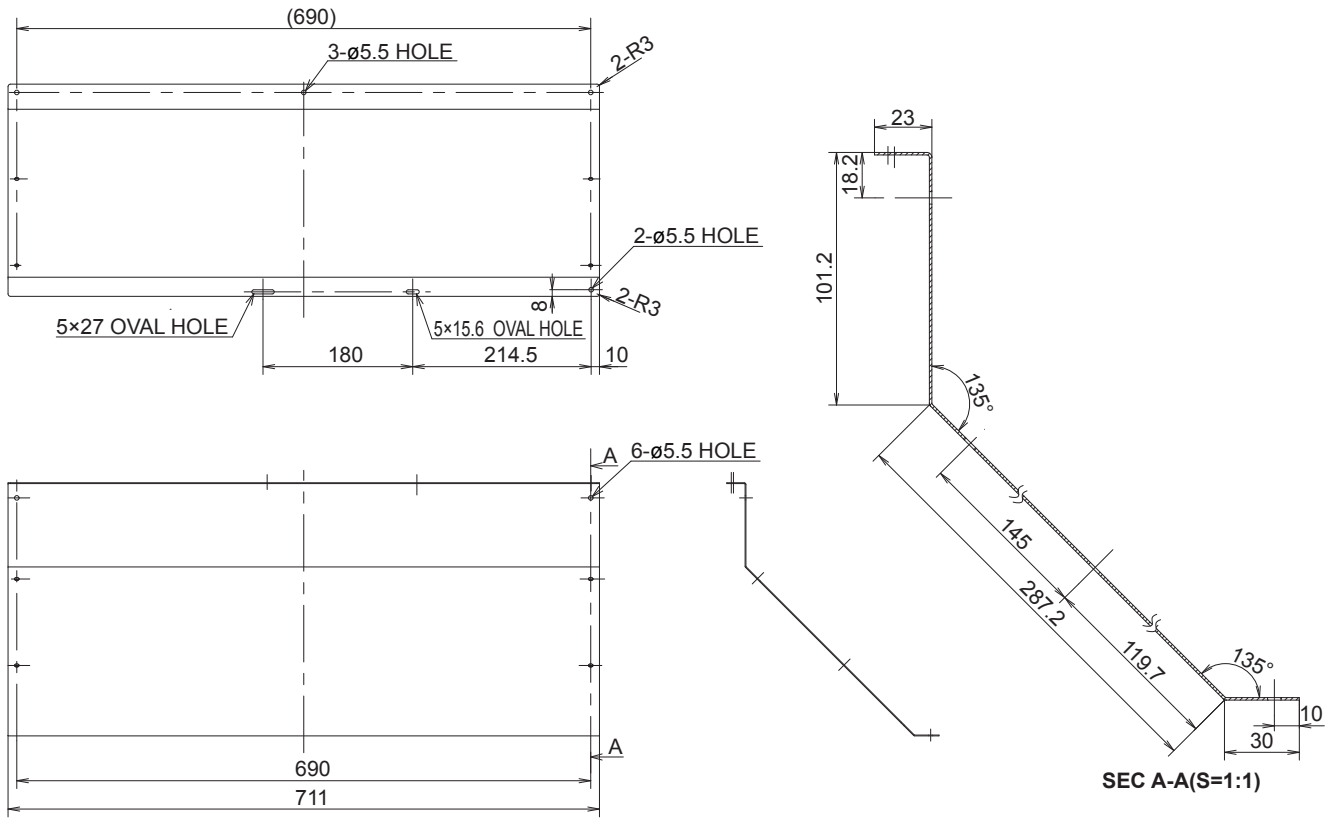
⑦ Reference diagram for Snow-proof Left side 1 (field supply)

Unit: mm



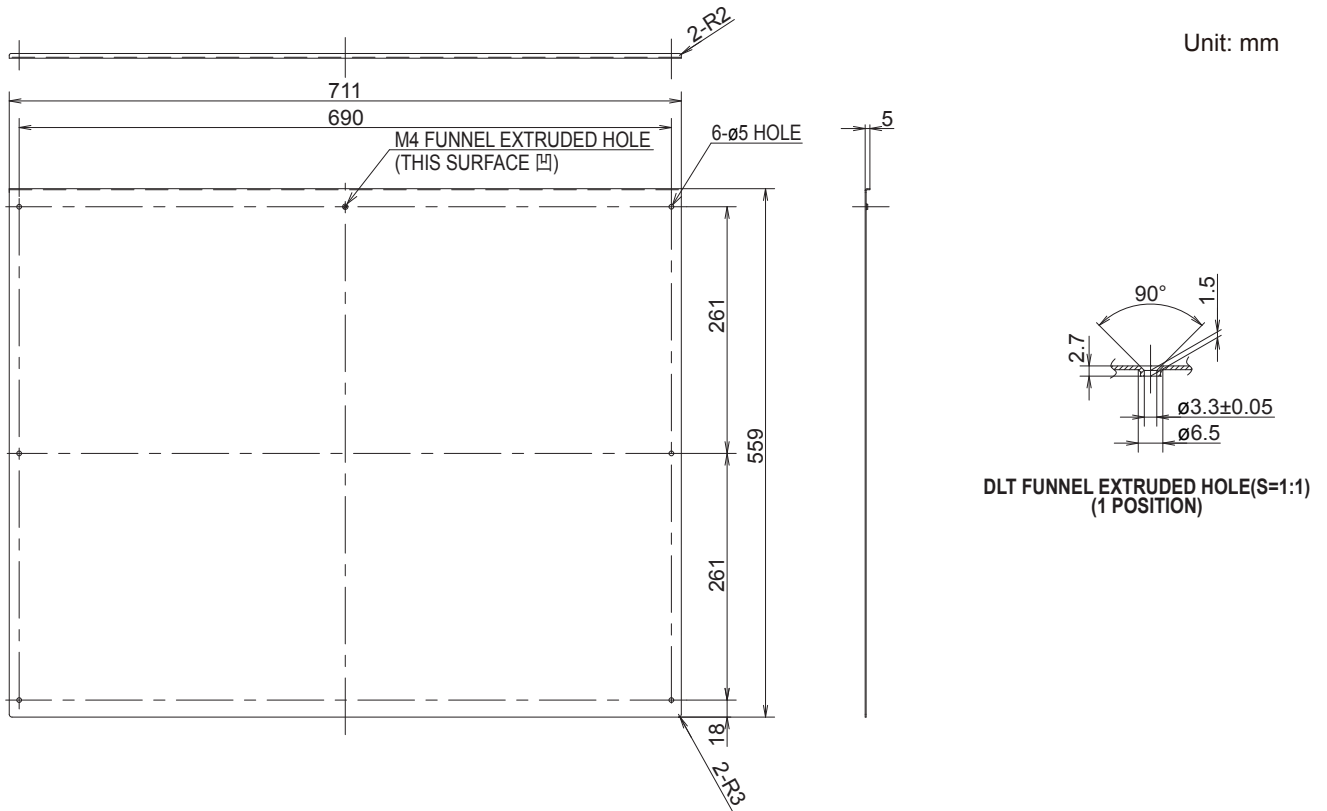
⑧ Reference diagram for Snow-proof Top side 2 (field supply)

Unit: mm



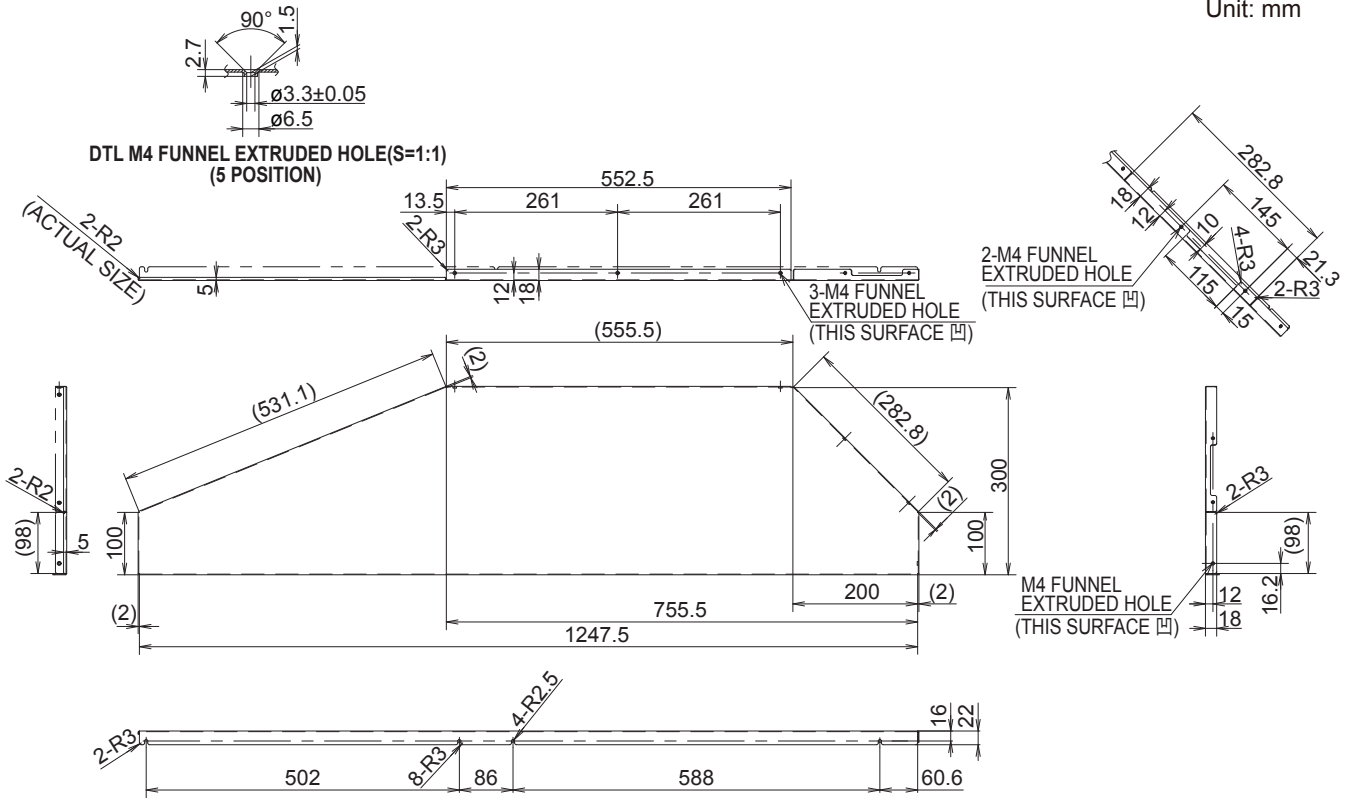
⑨ Reference diagram for Snow-proof Rear side 2 (field supply)

Unit: mm



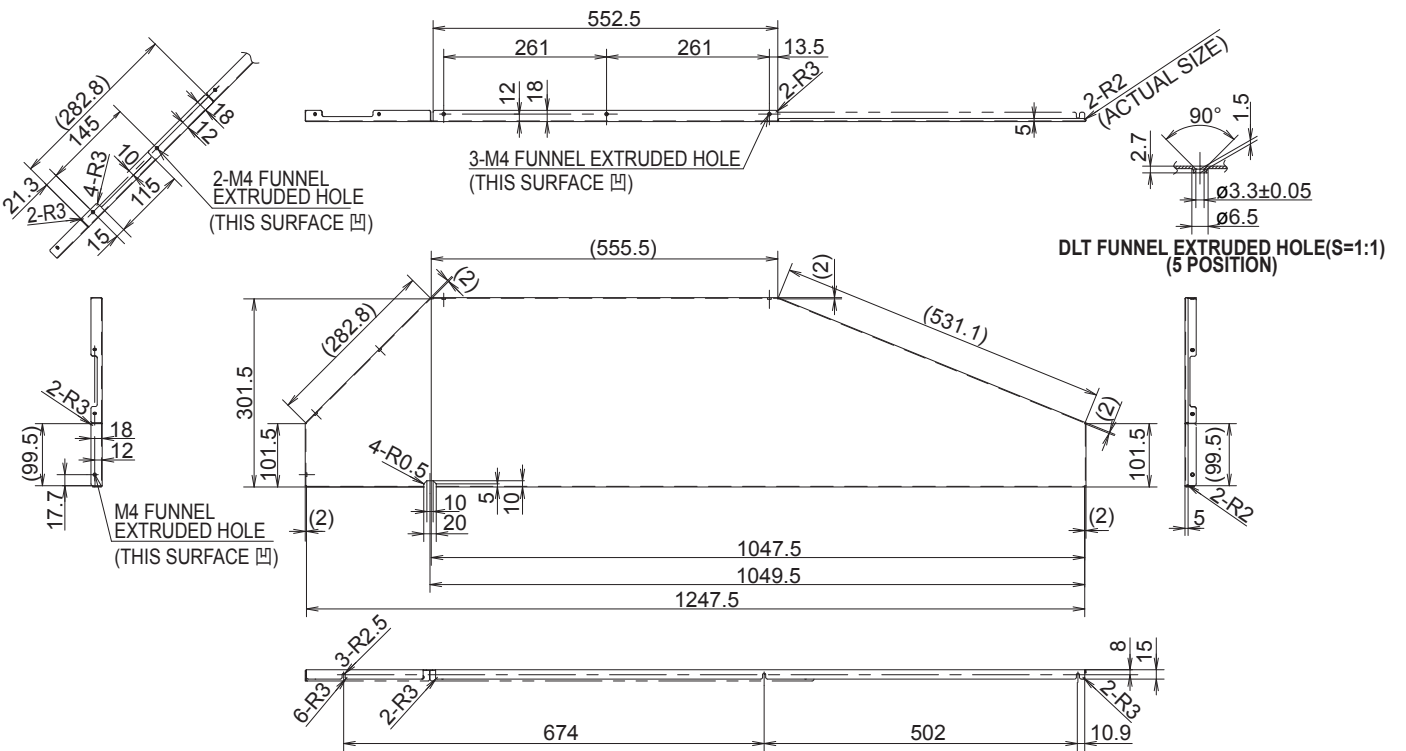
⑩ Reference diagram for Snow-proof Right side 2 (field supply)

Unit: mm



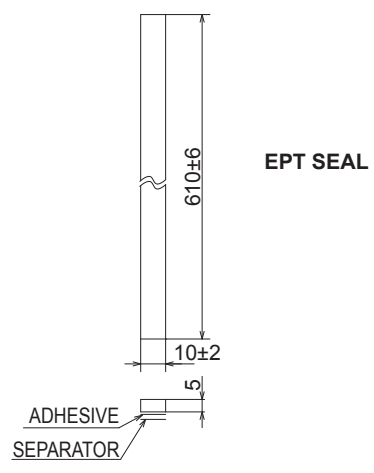
⑪ Reference diagram for Snow-proof Left side 2 (field supply)

Unit: mm



⑫ Reference diagram for Packing (field supply)

Unit: mm



■ Indoor Unit

Type E3

1. S-200PE3E5B, S-250PE3E5B

SELECTING THE INSTALLATION SITE

AVOID:

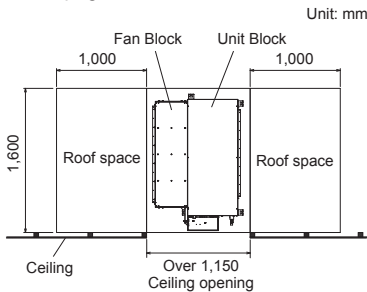
- areas where leakage of flammable gas may be expected.
- places where large amounts of oil mist exist.
- direct sunlight.
- locations near heat sources which may affect the performance of the unit.
- locations where external air may enter the room directly. This may cause “condensation” on the air discharge ports, causing them to spray or drip water.
- locations where the remote controller will be splashed with water or affected by dampness or humidity.
- installing the remote controller behind curtains or furniture.
- locations where high-frequency emissions are generated.
- places where blocked air passages.
- places where the false ceiling is not noticeably on an incline.

DO:

- select an appropriate position from which every corner of the room can be uniformly cooled.
- select a location where the ceiling is strong enough to support the weight of the unit.
- make sure to install protective guards on the suction and discharge side to prevent somebody from touching the fan blades or heat exchanger.
- select a location where tubing and drain pipe have the shortest run to the outdoor unit.
- allow room for operation and maintenance as well as unrestricted air flow around the unit.
- install the unit within the maximum elevation difference above or below the outdoor unit and within a total tubing length (L) from the outdoor unit as detailed in the Installation Instructions packed with the outdoor unit.
- allow room for mounting the remote controller about 1 m off the floor, in an area that is not in direct sunlight or in the flow of cool air from the indoor unit.
- places where optimum air distribution can be ensured.
- places where sufficient clearance for maintenance and service can be ensured.

When transporting the indoor unit to the roof space through the ceiling opening

Transport is possible without separation with a ceiling opening dimension of over 500 × 1,150 mm and a roof space dimension as shown below. After transporting the unit, see section “HOW TO INSTALL THE INDOOR UNIT” on page 1-12-2-1-3.

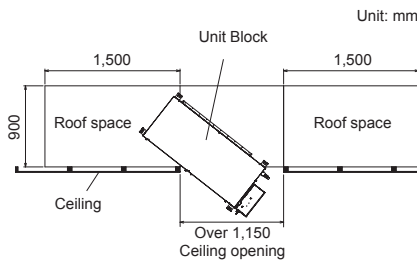


It is possible to separate the indoor unit into Fan Block and Unit Block.

Separated transport if necessary

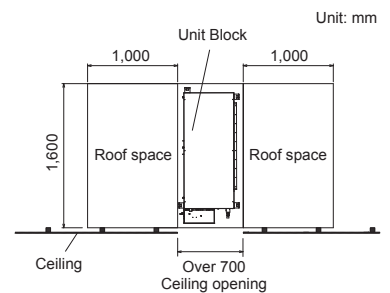
<Case 1>

If a ceiling opening dimension is over 500 × 1,150 mm and a roof space dimension is shown below, the indoor unit can be separated to fit through the space. For separating procedure, see section “How to separate the indoor unit” on page 1-12-2-1-2.



<Case 2>

If a ceiling opening dimension is over 500 × 700 mm and a roof space dimension is shown below, the indoor unit can be separated to fit through the space. For separating procedure, see section “How to separate the indoor unit” on page 1-12-2-1-2.

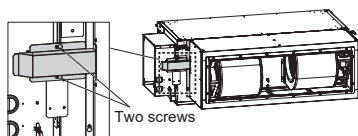


Criteria for ceiling opening dimension and height of roof space

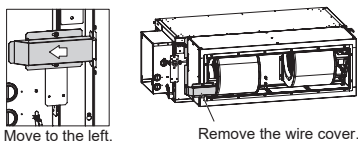
Unit: mm		
Width of ceiling opening	Height of roof space	Necessity of separating indoor unit
1,150	1,600	Unnecessary
1,150	900	Necessary
700	1,600	Necessary

How to separate the indoor unit

1. Remove the wire cover.
 - (1) Loosen two screws.

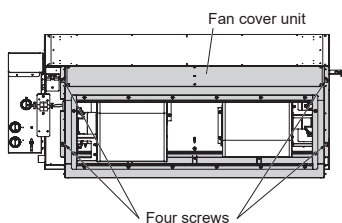


- (2) Move to the left and remove the wire cover through the round hole.

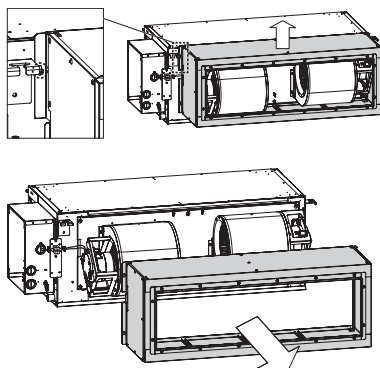


2. Remove the fan cover unit.

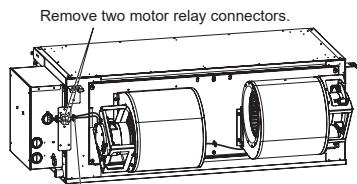
- (1) Loosen four screws.



- (2) Move the fan cover unit upward and remove it through the round hole.



3. Remove the motor relay connector.



Remove the wire from the fixed mounting bracket.

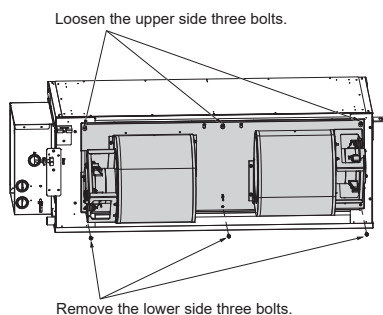
4. Separate the fan motor unit and heat exchanger unit.

- (1) Loosen the upper side three bolts and remove the lower side three bolts.

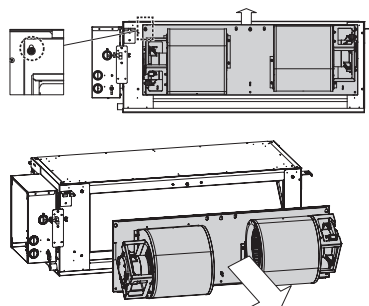


WARNING

Do not remove the upper side three bolts. The motor unit may drop during work of unit separation and can lead to personal injury or death.



- (2) Move upward and remove the fan motor unit through the round hole.

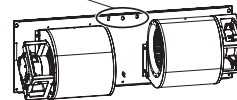


How to assemble the indoor unit

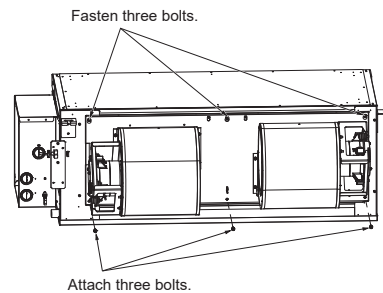
1. Attach the fan motor unit.

- (1) Pass the bolts for the heat exchanger unit through the round holes.

Mount the unit with three holes located in the center of the upper side.

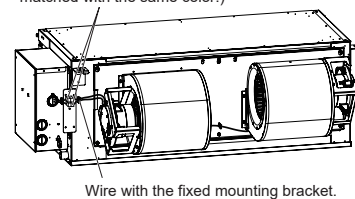


- (2) Attach three bolts in the lower side and then fasten three bolts in the upper side. (Tightening torque : 2.45 ~ 3.4 N · m)



- (3) Attach the motor wire.

Attach two motor connectors. (Connectors at each end should be matched with the same color.)



2. Attach the fan cover unit and wire cover. Attach the fan cover unit and wire cover in reverse order of separating unit.

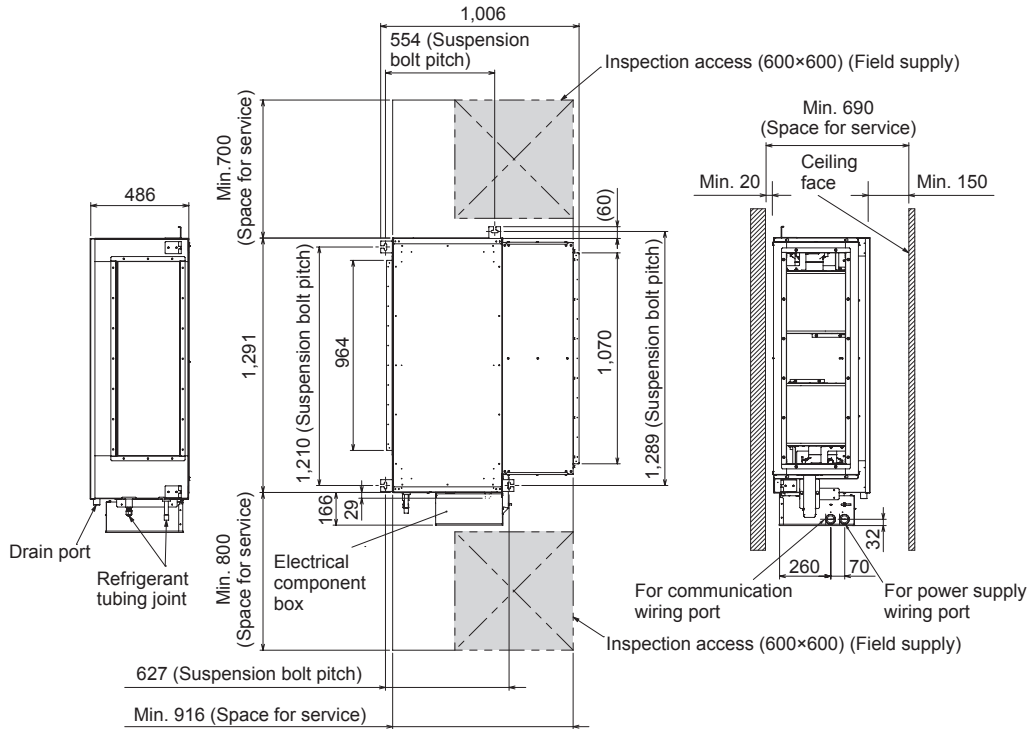
HOW TO INSTALL THE INDOOR UNIT

High Static Pressure Ducted Type
S-200PE3E5B / S-250PE3E5B

Required Minimum Space for Installation and Service

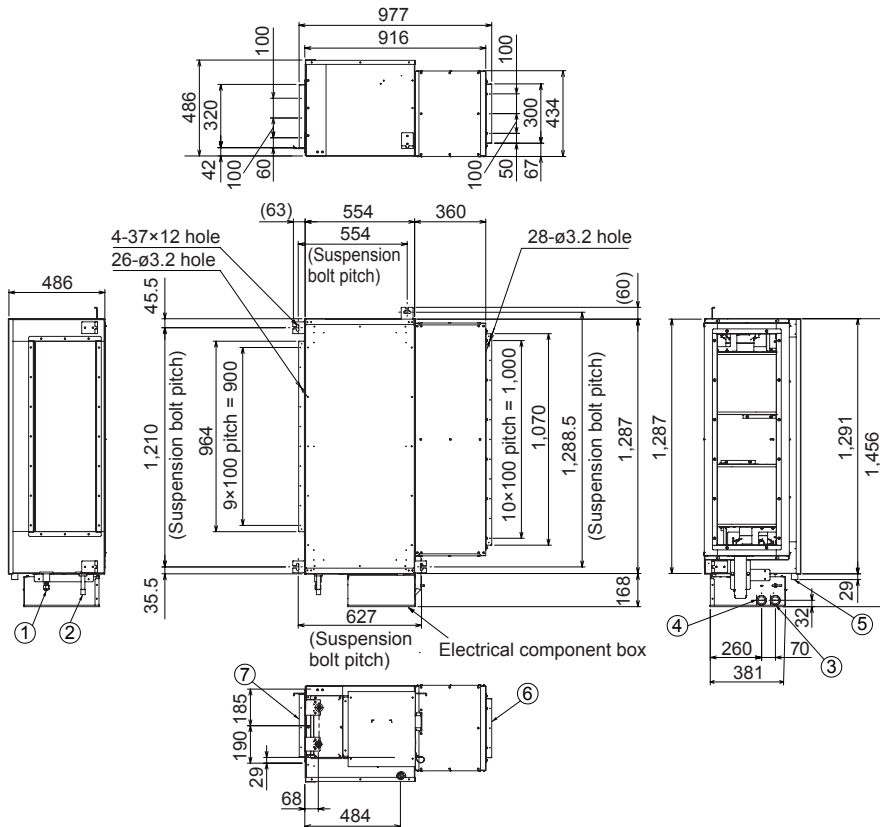
(1) Dimensions of suspension bolt pitch and unit

Unit: mm



(2) Dimensions of indoor unit

Unit: mm



①	Refrigerant liquid tubing (Flare) ø12.7 (Type 200 : Connection Tubing ø12.7 → ø9.52)
②	Refrigerant gas tubing (Brazing) ø19.05 (Connection Tubing ø19.05 → ø25.4)
③	Power supply port
④	Communication port
⑤	Drain port VP25
⑥	Air intake duct connecting side flange
⑦	Air discharge duct connecting side flange

Suspending the Indoor Unit

Depending on the ceiling type:

1. Check the suspension bolt pitch.
2. Ensure that the ceiling is strong enough to support the weight of the unit.
3. To prevent the unit from dropping, firmly fasten the suspension bolts as shown in the figure below.

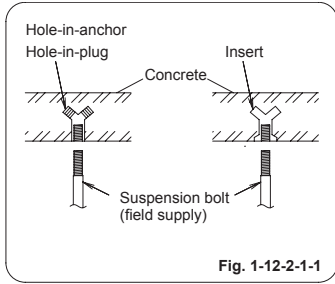


Fig. 1-12-2-1-1

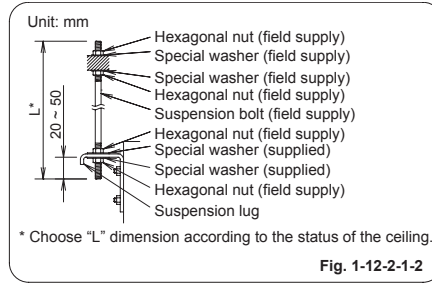


Fig. 1-12-2-1-2

NOTE

Suspension bolt (field supply)	M10 or 3/8"
--------------------------------	-------------

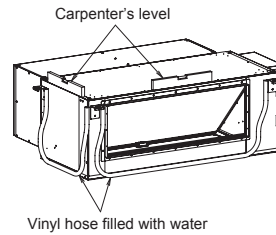
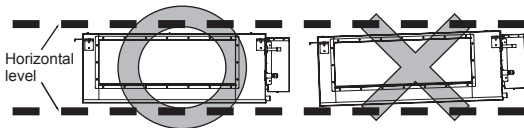
It is important that you use extreme care in supporting the indoor unit inside the ceiling.

WARNING Ensure that the ceiling is strong enough to support the weight of the unit. Before suspending the unit, test the strength of each attached suspension bolt.

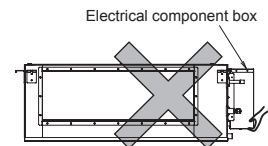
- (1) When placing the unit inside the ceiling, determine the pitch of the suspension bolts referring to the dimensional data given previously. Tubing must be laid and connected inside the ceiling when suspending the unit. If the ceiling is already constructed, lay the tubing into position for connection to the unit before placing the unit inside the ceiling.
- (2) Screw in the suspension bolts allowing them to protrude from the ceiling as shown in Fig. 1-12-2-1-1. (Cut the ceiling material, if necessary.)
- (3) Suspend and fix the indoor unit using the 2 hexagonal nuts (field supply) and special washers (supplied with the unit) as shown in Fig. 1-12-2-1-2.

CAUTION

- The top of the unit must be installed horizontally.



- Check the unit is placed horizontally. Make sure the unit is installed level using a level or a vinyl hose filled with water. In using a vinyl hose instead of a level, adjust the top surface of the unit to the surface of the water at both ends of the vinyl hose and make horizontal adjustment on all 4 corners of the unit. If the air discharge side of the unit is installed downward, splashing water or water leak may occur. Also, the dust may accumulate inside the drain pan caused by draining residual water.
- When lifting the unit, do not attempt to hold the electrical component box in hand.



Installing the Refrigerant Tubing

The size of the refrigerant tubing is as shown in the table below.

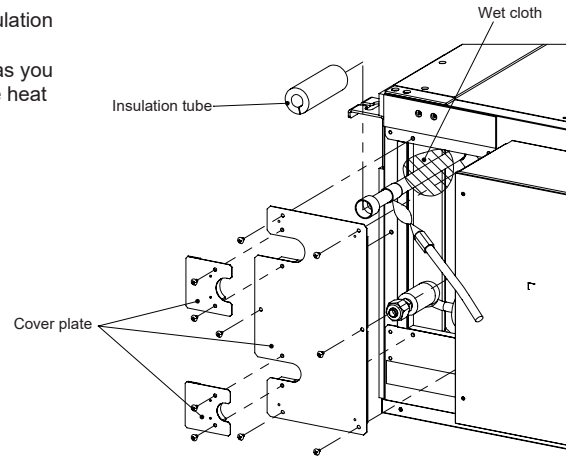
Table 1-12-2-1-1

Type	200	250
Gas tube	ø25.4 (Brazeing connection)	ø25.4 (Brazeing connection)
Liquid tube	ø9.52 (Brazeing connection) (Connection Tubing ø12.7 → ø9.52) ø12.7 (Flare connection) Tightening torque (approximate) : 49 ~ 55 N · m Thickness of connecting tube : 0.8 mm	ø12.7 (Flare connection) Tightening torque (approximate) : 49 ~ 55 N · m Thickness of connecting tube : 0.8 mm

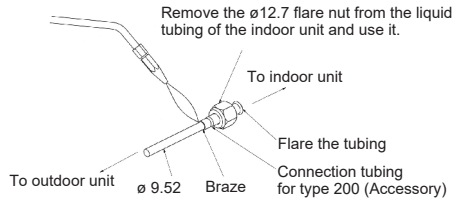
NOTE

To fasten the flare nuts, apply specified torque.

- When brazing, must be cool the pipe by wet cloths after removing the insulation tube and the cover plate.
- When brazing the gas tubing, cool the tubing with dampened shopcloths as you work, as shown in the figure below, to protect the unit's thermistor from the heat generated by brazing.
- When brazing, be careful not to heat the electrical component box. Doing so may cause the unit to be damaged.



- The type 200 indoor unit comes with a connection tubing that is for liquid tubing. Configure as shown in the illustration and connect it. When flaring the tube, put the flare nut onto it first and then flare it.



- Pipe insulation must be made after leak detection for tubing connection area was performed.
- Be sure to insulate both the gas tubing and liquid tubing. In addition, wrap the supplied insulation material around the tubing joints, and fasten in place with vinyl tape or other means. Failure to insulate the tubing may result in water leakage from condensation.
- Plug all gaps at tube through-holes in the unit with insulation or a similar substance to prevent air leakage.

Installing the Drain Piping

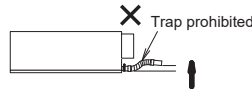
1. Before Performing the Installation Drain Piping

- (1) Prepare standard hard PVC pipe (O.D. 32 mm) for the drain and use the supplied drain socket to prevent water leaks. The PVC pipe must be purchased separately. When doing this, apply adhesive for the PVC pipe at the connection point. See section "2. Installing the Drain Pipe" on page 1-12-2-1-6.

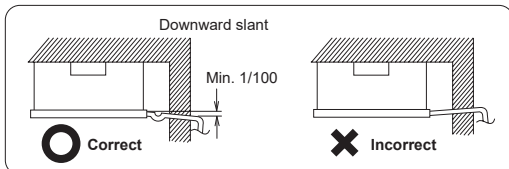
- (2) Limitations of Drain Hose Connection

⚠ CAUTION

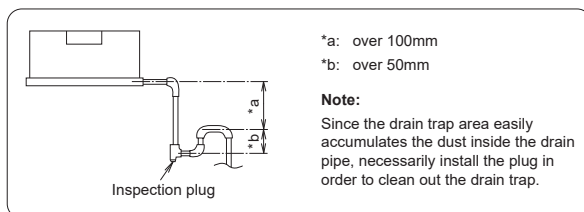
- Do not make a trap in the middle of the supplied drain pipe. Doing so will cause abnormal sound.



- (3) Ensure the drain pipe has a downward slant (1/100 or more).



- (4) The drain pipe with a trap should be installed away from the indoor unit.
- (5) Do not attach any air purge equipment. If attached, drain water may result in splashing out of the drain pipe.
- (6) When the drain piping is completed, perform the water leak test and check for a water leak. If detected, it may result in water leakage or condensation.
- (7) When the drain piping is completed, perform the drainage test if the water drains smoothly. If not draining smoothly, it may result in water leakage or condensation.
- (8) When the drain piping work is finished securely, wrap the insulation material around the indoor side drain pipe. At this time, do not wrap together with the refrigerant tubing. If wrapped together, the drain pipe is lifted and water drainage will not be operated. Consequently, the water comes out of the drain pan and it can lead to water leakage.



2. Installing the Drain Pipe

⚠ CAUTION

(1) How to Connect Drain Port and Drain Hose

- First insert the supplied hose band into the drain port pipe. Then make sure the head of the screw is facing toward a technical engineer when placing the screw of the hose band at an upward angle.

- Insert the soft PVC socket of the supplied drain hose to the drain port pipe.

Never apply the adhesive to the both ends of the soft PVC socket and the drain port pipe.

- Insert the drain hose to the point where there is a difference in level as shown in the figure below and fasten it with the hose band 5 mm away from that position.

Tightening torque must be 2.5 ~ 3.4 N·m.

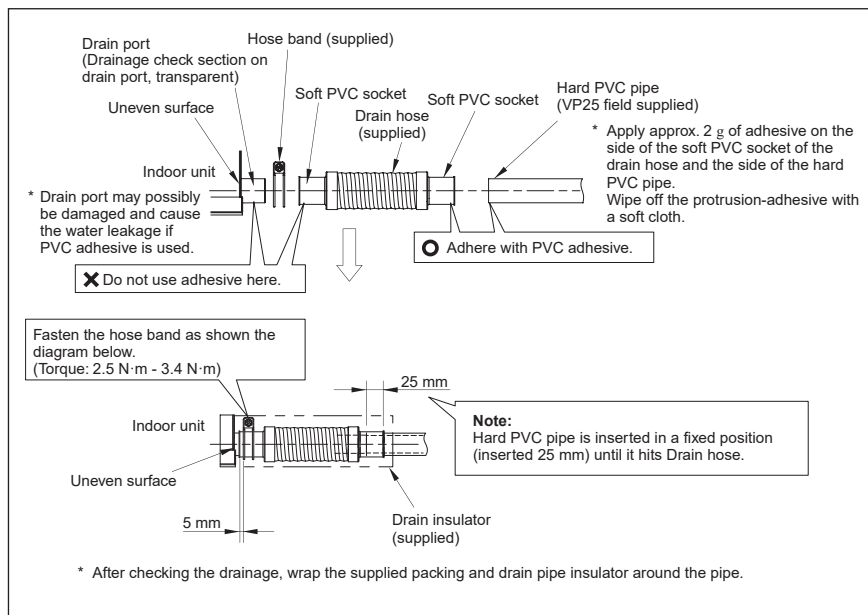
- Tightening position of the hose band must be upward.

(2) How to Install the Drain Pipe

- Connect the hard PVC pipe (O.D. 32 mm) to the side of the soft PVC socket of the drain hose.

- Apply approx. 2 g of adhesive on the side of the soft PVC socket of the drain hose and the side of the hard PVC pipe.

- Do not apply force to the drain port when connecting the drain pipe. Install and fix it near the indoor unit as close as possible.

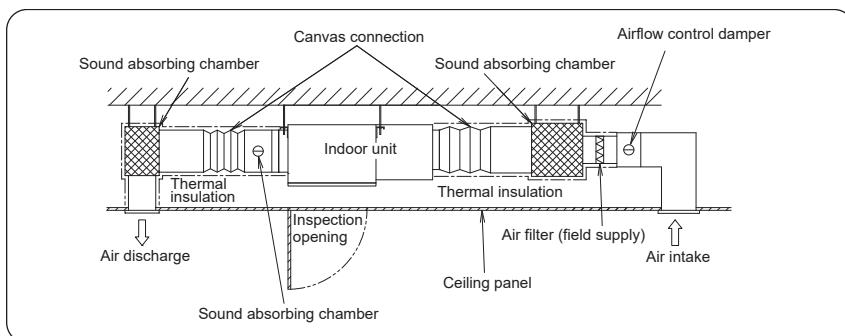


Caution for Ducting Work

- This unit has high static pressure.

In case of small pressure resistance (for instance, a short duct), install an airflow control damper (field supply) for adjusting airflow volume as airflow volume / airflow noise increases.

- If the air conditioner is to be installed in a room such as an office or meeting room which needs a low sound level, provide a supply and return sound absorption chamber with an acoustic liner.
- Use a flexible canvas connection or vibration isolation hanger (field supply) to break transmission of mechanical vibration of the unit.



⚠ CAUTION

- Use incombustible duct materials.
- Use thermal insulation to prevent duct condensation.
- An air filter (field supply) must be installed at the air intake side. If not installed, the heat exchanger will get dirty and the unit will reduce the quality.
- Obtain and install an air filter (field supply) which can easily wash away the dust by lukewarm, soapy water or suck up with a vacuum cleaner.
- Clean the air filter periodically to collect dust and other particles from the air.
- Use duct static pressure within a range of specification value.

EXTERNAL STATIC PRESSURE SETTING

Choose one of the methods (selection of “a”, “b”, “c” within the range of dotted line as shown in the flowchart below) and make settings.

a. No setting changes:

When using as it is factory preset at shipment.

(If resetting after external static pressure setting once, it might be different from factory preset.)

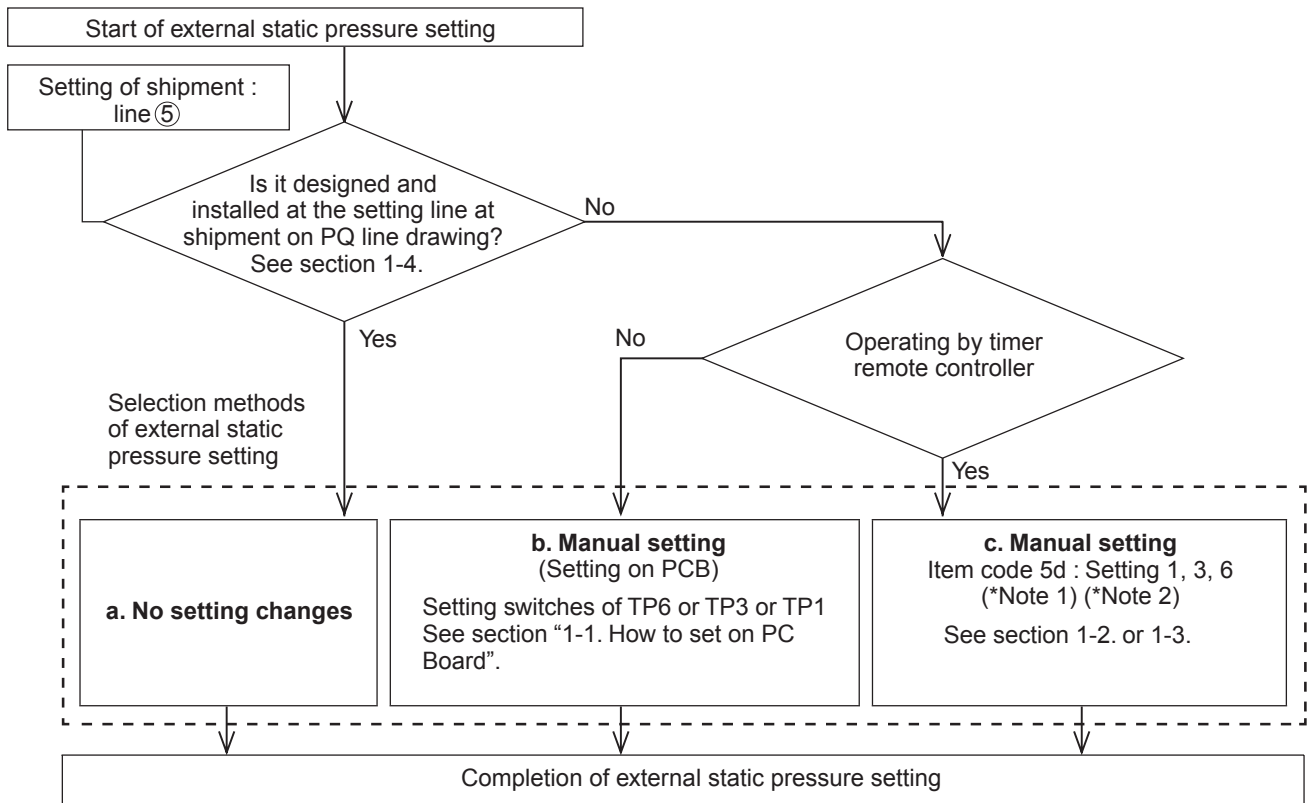
b. Manual setting (on PCB):

This is static pressure setting excepting factory preset at shipment. Dip switch select method.

c. Manual setting (by timer remote controller):

Static pressure setting excepting factory preset at shipment.

Flow of External Static Pressure



NOTE

- (1) Refer to Tables 1-12-2-1-3, 1-12-2-1-4 and Fig. 1-12-2-1-4 for details on the relationship between the value of item code “5d” and the external static pressure.
- (2) When set in group control (connecting multiple indoor units with one timer remote controller), set each indoor unit to item code “5d”.
When amending the setting after selecting [b. Manual setting] (due to airflow path changes, etc.), it is necessary to cancel [b. Manual setting] (switching OFF positions).
When [b. Manual setting] has not been cancelled, [c. Manual setting] will be activated if selected, but [b. Manual setting] takes precedence when the power is switched back on after power outages, etc.



CAUTION

- **Make sure the external static pressure is in a range of specifications. Then proceed the external static pressure setting. Improper settings can cause noise, a shortage of airflow volume and water leakage. Refer to Fig. 1-12-2-1-4 for the external static pressure setting range.**
- **Be sure to set the [External Static Pressure Setting] once again after amending the airflow path for the duct or air outlet after setting the external static pressure.**

1-1. How to Set on PC Board

1. Turn off the power breaker to halt the supply of electricity to the PC board.
2. Open the lid of the electrical component box and confirm the location where the Select switch on the indoor unit control PCB is placed. (Fig. 1-12-2-1-3)
3. Set the On/Off switches in the Off position which are now set in the On position.
Select the positions of the Select SW001 switches respectively to make the desired external static pressure settings referring to the Table 1-12-2-1-2.

Table 1-12-2-1-2 External static pressure SW setting

External static pressure at the time of rated airflow volume		SW001		
200	250	TP6	TP3	TP1
180Pa	200Pa	ON 1	2	3
120Pa	130Pa	1	ON 2	3
75Pa	75Pa	1	2	ON 3

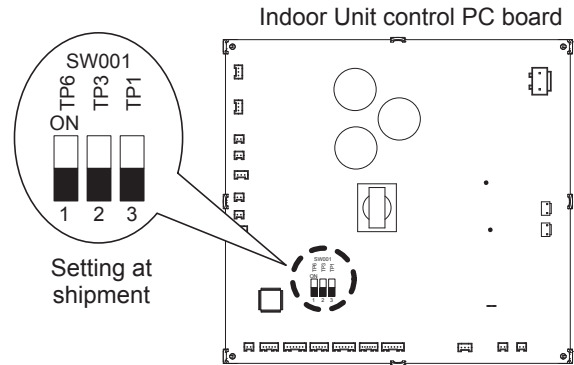


Fig. 1-12-2-1-3

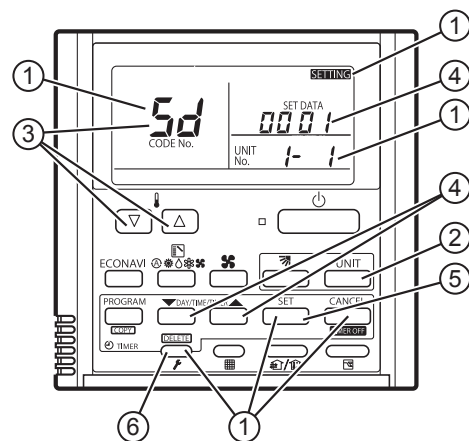
1-2. Operating the Timer Remote Controller (CZ-RTC4)

How to set the external static pressure

1. Press and hold down the , and buttons simultaneously for 4 or more seconds. (**SETTING** , the Unit No., Item Code and Detailed Data will blink on the LCD display.)
2. The indoor unit numbers in the group control will be sequentially displayed whenever the Unit Select button is pressed .
Only the fan motor for the selected indoor unit will operate during this time.
3. Specify the “ **5d** ” item code by pressing the / buttons for the temperature setting buttons and confirm the values. (“ **0001** ” set at shipment)
4. Press the / buttons for the time to amend the values for the set data. Refer to Table 1-12-2-1-3 and Fig. 1-12-2-1-4 and select a value “ **0006** ”, “ **0003** ” or “ **0001** ”.
5. Press the button.
The display will stop blinking and remain illuminated.
6. Press the button. The fan motor will stop operating and the LCD display will return to the normal stop mode.

Table 1-12-2-1-3 Setting the external static pressure

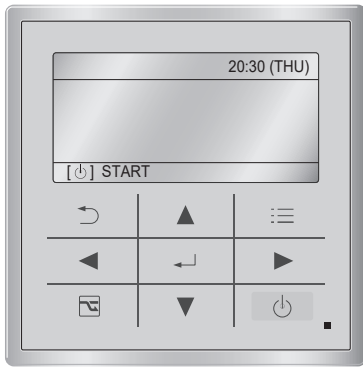
Indoor unit		Item code
200	250	
External static pressure of the rated air flow volume		5d
180 Pa	200 Pa	0006
120 Pa	130 Pa	0003
75 Pa	75 Pa	0001



NOTE:

Failure to set this parameter may result in decreased airflow and condensation.

1-3. Operating the High-spec Wired Remote Controller (CZ-RTC5B)



How to set the external static pressure

1. Keep pressing the , and buttons simultaneously for 4 or more seconds.

The "Maintenance func" screen appears on the LCD display.

Maintenance func	20:30 (THU)
0. ECONAVI info.	
1. Outdoor unit error data	
2. Service contact	
3. RC setting mode	
◀ Sel.	▶ Page [] Confirm

2. Press the or button to see beach menu. If you wish to see the next screen instantly, press the or button.

Select "8. Detailed settings" on the LCD display and press the button.

Maintenance func	20:30 (THU)
5. Sensor info.	
6. Servicing check	
7. Simple settings	
8. Detailed settings	
◀ Sel.	▶ Page [] Confirm

The "Detailed settings" screen appears on the LCD display.

Select the "Unit no." by pressing the or button for changes.

Detailed settings		20:30 (THU)
Unit no.	Code no.	Set data
3-1	10	0006
◀ Sel.	▶ Next	

3. Select the "Code no." by pressing the or button.

Change the "Code no." to "5D" by pressing the or button (or keeping it pressed).

Detailed settings		20:30 (THU)
Unit no.	Code no.	Set data
3-1	5D	0001
◀ Sel.	▶ Next	

4. Select the "Set data" by pressing the or button.

Select one of the "Set data" among "0006", "0003" or "0001" according to the desired external static pressure setting by pressing the or button.

(See Table 1-12-2-1-4 and Fig. 1-12-2-1-4.)

Then press the button.

Table 1-12-2-1-4 Setting the external static pressure

Indoor unit		Item code
200	250	
External static pressure of the rated air flow volume		5D
180 Pa	200 Pa	0006
120 Pa	130 Pa	0003
75 Pa	75 Pa	0001

5. Select the "Unit no." by pressing the or button and press the button.

The "Exit detailed settings and restart?"

(Detailed setting-end) screen appears on the LCD display.

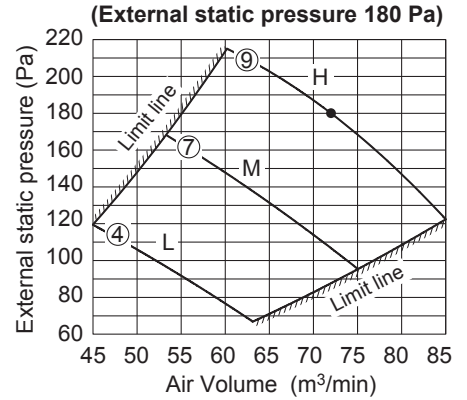
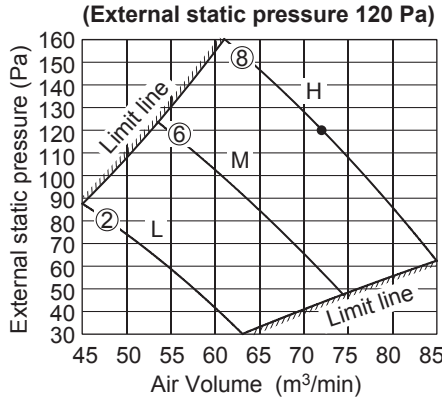
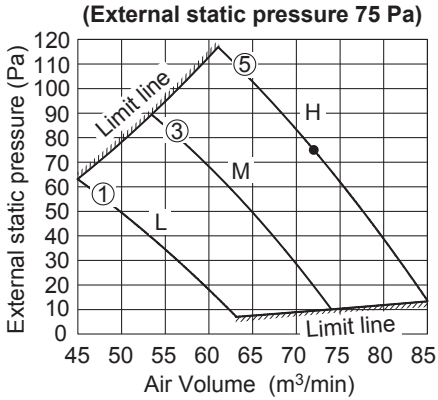
Select "YES" and press the button.

Exit detailed settings and restart?	
YES	NO

1-4. Indoor Fan Performance

			Tap								
			①	②	③	④	⑤	⑥	⑦	⑧	⑨
Item code "5d"	00 06	Cooling				L			M		H
		Heating				L			M		H
	00 03	Cooling		L					M		H
		Heating		L					M		H
	00 01	Setting at shipment	Cooling	L		M		H			
			Heating	L		M		H			

Type 200



Type 250

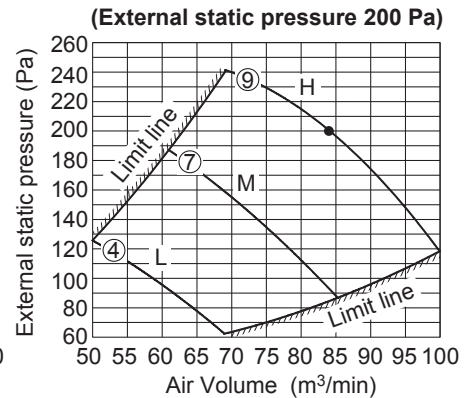
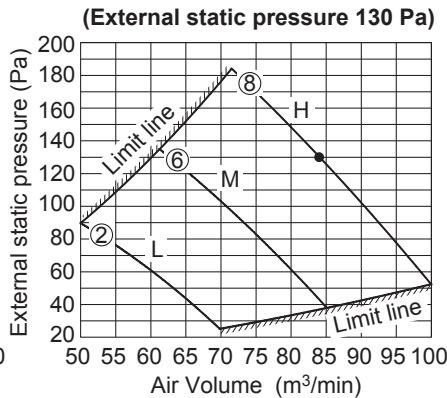
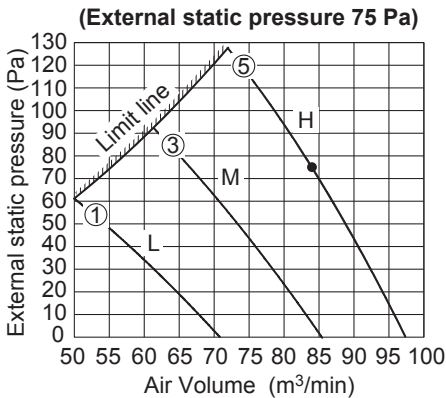


Fig. 1-12-2-1-4

HOW TO PROCESS TUBING

Must ensure mechanical connections be accessible for maintenance purposes.

The liquid tubing side is connected by a flare nut, and the gas tubing side is connected by brazing.

Connecting the Refrigerant Tubing

Use of the Flaring Method

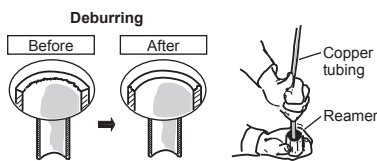
Many of conventional split system air conditioners employ the flaring method to connect refrigerant tubes that run between indoor and outdoor units. In this method, the copper tubes are flared at each end and connected with flare nuts.

Flaring Procedure with a Flare Tool

- (1) Cut the copper tube to the required length with a tube cutter. It is recommended to cut approx. 30 – 50 cm longer than the tubing length you estimate.
- (2) Remove burrs at each end of the copper tubing with a tube reamer or a similar tool.

This process is important and should be done carefully to make a good flare.

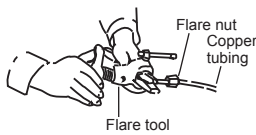
Be sure to keep any contaminants (moisture, dirt, metal filings, etc.) from entering the tubing.



NOTE

When reaming, hold the tube end downward and be sure that no copper scraps fall into the tube.

- (3) Remove the flare nut from the unit and be sure to mount it on the copper tube.
- (4) Make a flare at the end of the copper tube with a flare tool.



NOTE

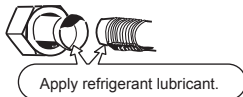
When flared joints are reused, the flare part shall be re-fabricated.

A good flare should have the following characteristics:

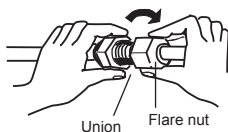
- inside surface is glossy and smooth
- edge is smooth
- tapered sides are of uniform length

Caution Before Connecting Tubes Tightly

- (1) Apply a sealing cap or water-proof tape to prevent dust or water from entering the tubes before they are used.
- (2) Be sure to apply refrigerant lubricant (ether oil) to the inside of the flare nut before making piping connections. This is effective for reducing gas leaks.



- (3) For proper connection, align the union tube and flare tube straight with each other, then screw on the flare nut lightly at first to obtain a smooth match.



- Adjust the shape of the liquid tube using a tube bender at the installation site and connect it to the liquid tubing side valve using a flare.

Cautions During Brazing

- Replace air inside the tube with nitrogen gas to prevent copper oxide film from forming during the brazing process. (Oxygen, carbon dioxide and Freon are not acceptable.)
- Do not allow the tubing to get too hot during brazing. The nitrogen gas inside the tubing may overheat, causing refrigerant system valves to become damaged. Therefore allow the tubing to cool when brazing.
- Use a reducing valve for the nitrogen cylinder.
- Do not use agents intended to prevent the formation of oxide film. These agents adversely affect the refrigerant and refrigerant oil, and may cause damage or malfunctions.

Connecting Tubing Between Indoor and Outdoor Units

- (1) Tightly connect the indoor-side refrigerant tubing extended from the wall with the outdoor-side tubing.

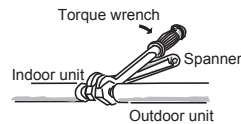
Indoor Unit Tubing Connection

Indoor unit type	200	250
Gas tubing (mm)	ø25.4	ø25.4
Liquid tubing (mm)	ø9.52	ø12.7

- (2) To fasten the flare nuts, apply specified torque.

- When removing the flare nuts from the tubing connections, or when tightening them after connecting the tubing, be sure to use a torque wrench and a spanner.

If the flare nuts are over-tightened, the flare may be damaged, which could result in refrigerant leakage and cause injury or asphyxiation to room occupants.



- For the flare nuts at tubing connections, be sure to use the flare nuts that were supplied with the unit, or else flare nuts for R410A, R32 (type 2). The refrigerant tubing that is used must be of the correct wall thickness as shown in the table below.

Tube diameter	Tightening torque (approximate)	Tube thickness
ø9.52 (3/8")	34 – 42 N · m {340 – 420 kgf · cm}	0.8 mm
ø12.7 (1/2")	49 – 55 N · m {490 – 550 kgf · cm}	0.8 mm

Because the pressure is approximately 1.6 times higher than conventional refrigerant R22 pressure, the use of ordinary flare nuts (type 1) or thin-walled tubes may result in tube rupture, injury, or asphyxiation caused by refrigerant leakage.

- In order to prevent damage to the flare caused by over-tightening of the flare nuts, use the table above as a guide when tightening.
- When tightening the flare nut on the liquid tube, use an adjustable wrench with a nominal handle length of 200 mm.

Insulating the Refrigerant Tubing

Tubing Insulation

Must ensure that pipe-work shall be protected from physical damage.

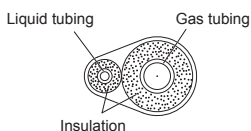
- Thermal insulation must be applied to all units tubing, including distribution joint (field supply).

* For gas tubing, the insulation material must be heat resistant to 120°C or above. For other tubing, it must be heat resistant to 80°C or above.

Insulation material thickness must be 10 mm or greater.

If the conditions inside the ceiling exceed DB 30°C and RH 70%, increase the thickness of the gas tubing insulation material by 1 step.

Two tubes arranged together



CAUTION

If the exterior of the outdoor unit valves has been finished with a square duct covering, make sure you allow sufficient space to access the valves and to allow the panels to be attached and removed.

Additional Precautions For R32 Models.

! Ensure to do the re-flaring of pipes before connecting to units to avoid leaking.

To prevent the ingress of moisture into the joint which could have the potential to freeze and then cause leakage, the joint must be sealed with suitable silicone and insulation material. The joint should be sealed on both liquid and gas side.

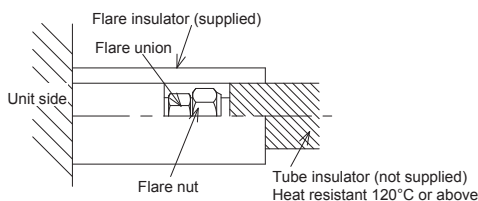


Insulation material and silicone sealant. Please ensure there are no gaps where moisture can enter the joint.

Silicone Sealant must be neutral cure and ammonia free. Use of silicon containing ammonia can lead to stress corrosion on the joint and cause leakage.

Taping the flare nuts

Wind the white insulation tape around the flare nuts at the gas tube connections. Then cover up the tubing connections with the flare insulator, and fill the gap at the union with the supplied black insulation tape. Finally, fasten the insulator at both ends with the supplied vinyl clamps.



Insulation material

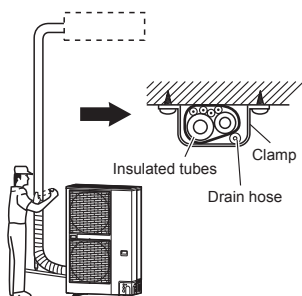
The material used for insulation must have good insulation characteristics, be easy to use, be age resistant, and must not easily absorb moisture.

CAUTION

After a tube has been insulated, never try to bend it into a narrow curve because it can cause the tube to break or crack. Never grasp the drain or refrigerant connecting outlets when moving the unit.

Taping the Tubes

- (1) At this time, the refrigerant tubes (and electrical wiring if local codes permit) should be taped together with armoring tape in 1 bundle. To prevent condensation from overflowing the drain pan, keep the drain hose separate from the refrigerant tubing.
- (2) Wrap the armoring tape from the bottom of the outdoor unit to the top of the tubing where it enters the wall. As you wrap the tubing, overlap half of each previous tape turn.
- (3) Clamp the tubing bundle to the wall, using 1 clamp approx. each meter.

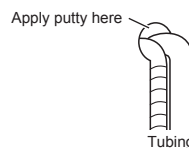


NOTE

Do not wind the armoring tape too tightly since this will decrease the heat insulation effect. Also ensure that the condensation drain hose splits away from the bundle and drips clear of the unit and the tubing.

Finishing the Installation

After finishing insulating and taping over the tubing, use sealing putty to seal off the hole in the wall to prevent rain and draft from entering.



HOW TO INSTALL THE TIMER REMOTE CONTROLLER OR HIGHSPEC WIRED REMOTE CONTROLLER (OPTIONAL PART)

NOTE

See "Section 2. TEST RUN".

Accessories Supplied with Unit

Part Name	Figure	Q'ty	Remarks
Special washer		8	For indoor unit suspension
Insulator		2	For gas and liquid tubes
Drain hose		1	
Hose band		1	For securing drain hose
Drain insulator		1	
Connection tubing		1	ø19.05 → ø25.4
		1	Type 200 : ø12.7 → ø9.52
Clamper		2	For power supply code / control wiring
Operating Instructions		1	
Installation Instructions		1	

• Use M10 or 3/8" suspension bolt. (field supply)

Type of Copper Tube and Insulation Material

If you wish to purchase these materials separately from a local source, you will need:

1. Deoxidized annealed copper tube for refrigerant tubing.
2. Foamed polyethylene insulation for copper tubes as required to precise length of tubing. Insulation material thickness must be 10 mm or greater.
3. Use insulated copper wire for field wiring. Wire size varies with the total length of wiring. See section "1-10. ELECTRICAL WIRING" for details.

CAUTION

Check local electrical codes and regulations before obtaining wire. Also, check any specified instructions or limitations.

Additional Materials Required for Installation

1. Refrigeration (armored) tape
2. Insulated staples or clamps for connecting wire (See your local codes.)
3. Putty
4. Refrigeration tubing lubricant
5. Clamps or saddles to secure refrigerant tubing
6. Scale for weighing

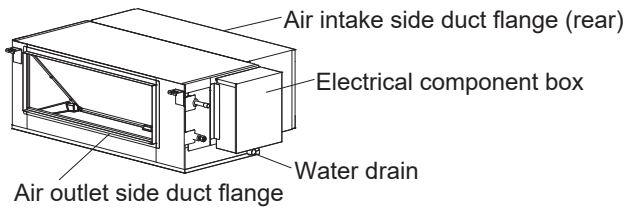
CHECKLIST AFTER INSTALLATION WORK

Work List	No.	Content	Check <input checked="" type="checkbox"/>	Possibility of Failure & Checkpoint
Installation	1	Are the indoor units installed following the content on page 1-12-2-1-1 "SELECTING THE INSTALLATION SITE"?	<input type="checkbox"/>	There is a possibility of light injure or loss of property.
Tubing & Wiring	2	Is the earth leakage circuit breaker (all-pole switching function provided) installed?	<input type="checkbox"/>	Power failure or short circuit may cause electric shock or fire. Check installation work and ground wire work.
	3	Is there any wrong installation of optional parts or wrong wiring?	<input type="checkbox"/>	
	4	Was the ground wire work performed?	<input type="checkbox"/>	
	5	Are there any wrong power supply wiring, wrong connection wire, wrong signal wire or loose screw?	<input type="checkbox"/>	
	6	Is the thickness of wire in accordance with rule?	<input type="checkbox"/>	
	7	Is the power-supply voltage equal to the nameplate of the unit?	<input type="checkbox"/>	
	8	Was the check of the airtight test, flared tube fitting and gas leakage on the welded portion performed?	<input type="checkbox"/>	If the gas leakage occurs, the unit quality not only becomes inferior but affects environment. Repair it as quickly as possible.
Drain Check	9	Is there water leakage?	<input type="checkbox"/>	Since there is a possibility of water drain, repair the drain pipe if the drain failure or water drain occurs.
	10	Indoor unit drain pipe has a downward gradient (1/100 or more) by rule. Is the drain water flowing smoothly?	<input type="checkbox"/>	
Heat Insulation	11	Was the heat insulation work at a suitable location including the flared tube fitting (refrigerant tube & drain pipe) performed properly?	<input type="checkbox"/>	The quality of unit not only becomes inferior but there is a possibility of the water drain. So, perform the heat insulation work properly.
Test Run	12	Did the abnormal sound occur?	<input type="checkbox"/>	Check if there is a fan contact or distortion of the indoor unit.
	13	Did the cool and warm airflow discharge from the indoor unit?	<input type="checkbox"/>	Check if the unit does not operate or there is a wrong tubing or wiring connection with another system.

APPENDIX

■ Name of Parts

Type E3 (HIGH STATIC PRESSURE DUCTED)



■ Care and Cleaning

⚠ WARNING

- Engage authorized dealer or specialist for cleaning.
- For safety, be sure to turn the air conditioner off and also to disconnect the power before cleaning.
- Do not pour water on the indoor unit to clean it. This will damage the internal components and cause an electric shock hazard.

Air intake and outlet side (Indoor unit)

Clean the air intake and outlet side of the indoor unit with a vacuum cleaner brush, or wipe them with a clean, soft cloth. If these parts are stained, use a clean cloth moistened with water. When cleaning the air outlet side, be careful not to force the vanes out of place.

⚠ CAUTION

- Never use solvents or harsh chemicals when cleaning the indoor unit. Do not wipe plastic parts using very hot water.
- Some metal edges and the fins are sharp and may cause injury if handled improperly; be especially careful when you clean these parts.
- The internal coil and other components of outdoor unit must be cleaned regularly. Consult your dealer or service center.

Air filter

- In case of Installing the Duct (field supply)

Type	E3
Period	(Depends on filter's specifications)

When cleaning the air filter, consult your dealer or service center.

⚠ CAUTION

- Certain metal edges and the condenser fins are sharp and may cause injury if handled improperly; special care should be taken when you clean these parts.
- The internal coil and other components must also be cleaned periodically. Consult your dealer or service center.

Care: After a prolonged idle period

Check the indoor and outdoor unit air intakes and outlets for blockage; if there is a blockage, remove it.

Care: Before a prolonged idle period

- Operate the fan for half a day to dry out the inside.
- Disconnect the power supply and also turn off the circuit breaker.
- Clean the air filter and replace it in its original position.

NOTE

Should the power fail while the unit is running

If the power supply for this unit is temporarily cut off, the unit will automatically resume operation once power is restored using the same settings before the power was interrupted.

IMPORTANT INFORMATION REGARDING THE REFRIGERANT USED

NOTE

See "■ Outdoor Unit" under the Section 1-12. Installation Instructions.

SERVICING



CAUTION

- Any qualified person who is involved with working on or breaking into a refrigerant circuit should hold a current valid certificate from an industry-accredited assessment authority, which authorizes their competence to handle refrigerants safely in accordance with an industry recognised assessment specification.
 - Servicing shall only be performed as recommended by the equipment manufacturer. Maintenance and repair requiring the assistance of other skilled personnel shall be carried out under the supervision of the person competent in the use of flammable refrigerants.
 - Servicing shall be performed only as recommended by the manufacturer.
 - Prior to beginning work on systems containing flammable refrigerants, safety checks are necessary to ensure that the risk of ignition is minimised. For repair to the refrigerating system, (2) to (6) shall be completed prior to conducting work on the system.
- (1) Work shall be undertaken under a controlled procedure so as to minimise the risk of a flammable gas or vapour being present while the work is being performed.
 - (2) All maintenance staff and others working in the local area shall be instructed on the nature of work being carried out. Work in confined spaces shall be avoided. The area around the workspace shall be sectioned off. Ensure that the conditions within the area have been made safe by control of flammable material.
 - (3) The area shall be checked with an appropriate refrigerant detector prior to and during work, to ensure the technician is aware of potentially toxic or flammable atmospheres. Ensure that the leak detection equipment being used is suitable for use with all applicable refrigerants, i.e. non-sparking, adequately sealed or intrinsically safe.
 - (4) If any hot work is to be conducted on the refrigeration equipment or any associated parts, appropriate fire extinguishing equipment shall be available to hand. Have a dry powder or CO₂ fire extinguisher adjacent to the charging area.
 - (5) No person carrying out work in relation to a refrigeration system which involves exposing any pipe work shall use any sources of ignition in such a manner that it may lead to the risk of fire or explosion. All possible ignition sources, including cigarette smoking, should be kept sufficiently far away from the site of installation, repairing, removing and disposal, during which refrigerant can possibly be released to the surrounding space. Prior to work taking place, the area around the equipment is to be surveyed to make sure that there are no flammable hazards or ignition risks. "No Smoking" signs shall be displayed.
 - (6) Ensure that the area is in the open or that it is adequately ventilated before breaking into the system or conducting any hot work. A degree of ventilation shall continue during the period that the work is carried out. The ventilation should safely disperse any released refrigerant and preferably expel it externally into the atmosphere.
 - (7) Where electrical components are being changed, they shall be fit for the purpose and to the correct specification. At all times the manufacturer's maintenance and service guidelines shall be followed. If in doubt, consult the manufacturer's technical department for assistance.
 - The charge size is in accordance with the room size within which the refrigerant containing parts are installed.
 - The ventilation machinery and outlets are operating adequately and are not obstructed.
 - Marking to the equipment continues to be visible and legible. Markings and signs that are illegible shall be corrected.
 - Refrigeration pipe or components are installed in a position where they are unlikely to be exposed to any substance which may corrode refrigerant containing components, unless the components are constructed of materials which are inherently resistant to being corroded or are suitably protected against being so corroded.
 - (8) Repair and maintenance to electrical components shall include initial safety checks and component inspection procedures. If a fault exists that could compromise safety, then no electrical supply shall be connected to the circuit until it is satisfactorily dealt with. If the fault cannot be corrected immediately but it is necessary to continue operation, an adequate temporary solution shall be used. This shall be reported to the owner of the equipment so all parties are advised. Initial safety checks shall include:
 - That capacitors are discharged. This shall be done in a safe manner to avoid possibility of sparking.
 - That no live electrical components and wiring are exposed while charging, recovering or purging the system.
 - That there is continuity of earth bonding.
- During repairs to sealed components, all electrical supplies shall be disconnected from the equipment being worked upon prior to any removal of sealed covers, etc.
 - Particular attention shall be paid to the following to ensure that by working on electrical components, the casing is not altered in such a way that the level of protection is affected. This shall include damage to cables, excessive number of connections, terminals not made to original specification, damage to seals, incorrect fitting of glands, etc.
 - Ensure that apparatus is mounted securely.
 - Ensure that seals or sealing materials have not degraded such that they no longer serve the purpose of preventing the ingress of flammable atmospheres.
 - Replacement parts shall be in accordance with the manufacturer's specifications.

NOTE:

The use of silicon sealant may inhibit the effectiveness of some types of leak detection equipment. Intrinsically safe components do not have to be isolated prior to working on them.

- Do not apply any permanent inductive or capacitance loads to the circuit without ensuring that this will not exceed the permissible voltage and current permitted for the equipment in use.
- Intrinsically safe components are the only types that can be worked on while live in the presence of a flammable atmosphere.
- The test apparatus shall be at the correct rating.
- Replace components only with parts specified by the manufacturer. Unspecified parts by manufacturer may result ignition of refrigerant in the atmosphere from a leak.

REMOVAL AND EVACUATION



CAUTION

- When breaking into the refrigerant circuit to make repairs – or for any other purpose – conventional procedures shall be used. However, it is important that best practice is followed since flammability is a consideration. The following procedure shall be adhered to:
 - Remove refrigerant.
 - Purge the circuit with inert gas.
 - Evacuate.
 - Purge again with inert gas.
 - Open the circuit by cutting or brazing.
- The refrigerant charge shall be recovered into the correct recovery cylinders.
- The system shall be “flushed” with Oxygen free nitrogen (OFN) to render the unit safe.
- This process may need to be repeated several times.
- Compressed air or oxygen shall not be used for this task.
- Flushing shall be achieved by breaking the vacuum in the system with Oxygen free nitrogen (OFN) and continuing to fill until the working pressure is achieved, then venting to atmosphere, and finally pulling down to a vacuum.
- This process shall be repeated until no refrigerant is within the system.
- When the final Oxygen free nitrogen (OFN) charge is used, the system shall be vented down to atmospheric pressure to enable work to take place.
- This operation is absolutely vital if brazing operations on the pipe work are to take place.
- Ensure that the outlet for the vacuum pump is not close to any ignition sources and there is ventilation available.

CHARGING PROCEDURES

NOTE

See “■ Outdoor Unit” under the Section 1-12. Installation Instructions.

DECOMMISSIONING



CAUTION

- Before carrying out this procedure, it is essential that the technician is completely familiar with the equipment and all its details.
- It is recommended good practice that all refrigerants are recovered safely.
- Prior to the task being carried out, an oil and refrigerant sample shall be taken in case analysis is required prior to re-use of reclaimed refrigerant.
- It is essential that electrical power is available before the task is commenced.
 - a) Become familiar with the equipment and its operation.
 - b) Isolate system electrically.
 - c) Before attempting the procedure ensure that:
 - Mechanical handling equipment is available, if required, for handling refrigerant cylinders.
 - All personal protective equipment is available and being used correctly.
 - The recovery process is supervised at all times by a competent person.
 - Recovery equipment and cylinders conform to the appropriate standards.
 - d) Pump down refrigerant system, if possible.
 - e) If a vacuum is not possible, make a manifold so that refrigerant can be removed from various parts of the system.
 - f) Make sure that cylinder is situated on the scales before recovery takes place.
 - g) Start the recovery machine and operate in accordance with manufacturer’s instructions.
 - h) Do not overfill cylinders. (No more than 80 % volume liquid charge).
 - i) Do not exceed the maximum working pressure of the cylinder, even temporarily.
 - j) When the cylinders have been filled correctly and the process completed, make sure that the cylinders and the equipment are removed from site promptly and all isolation valves on the equipment are closed off.
 - k) Recovered refrigerant shall not be charged into another refrigeration system unless it has been cleaned and checked.
- Electrostatic charge may accumulate and create a hazardous condition when charging or discharging the refrigerant. To avoid fire or explosion, dissipate static electricity during transfer by grounding and bonding containers and equipment before charging / discharging.

RECOVERY

NOTE

See “12. Recovery” on page 1-12-1-1-6.

Type U2

2. S-50PU2E5B, S-60PU2E5B, S-71PU2E5B, S-100PU2E5B, S-125PU2E5B

SELECTING THE INSTALLATION SITE

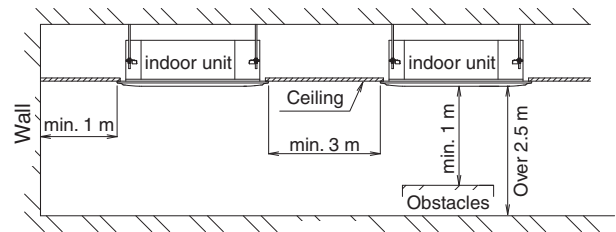
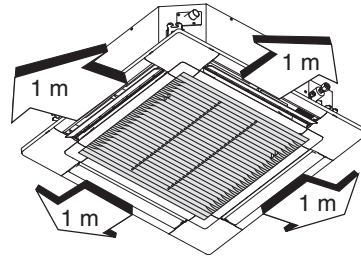
AVOID:

- areas where leakage of flammable gas may be expected.
- places where large amounts of oil mist exist.
- direct sunlight.
- locations near heat sources which may affect the performance of the unit.
- locations where external air may enter the room directly. This may cause “condensation” on the air discharge ports, causing them to spray or drip water.
- locations where the remote controller will be splashed with water or affected by dampness or humidity.
- installing the remote controller behind curtains or furniture.
- locations where high-frequency emissions are generated.

DO:

- select an appropriate position from which every corner of the room can be uniformly cooled.
- select a location where the ceiling is strong enough to support the weight of the unit.
- select a location where tubing and drain pipe have the shortest run to the outdoor unit.
- allow room for operation and maintenance as well as unrestricted air flow around the unit.
- the limitation of the tubing length between the indoor and the outdoor units should be referred to the Installation Instructions of the outdoor unit.
- allow room for mounting the remote controller about 1 m off the floor, in an area that is not in direct sunlight or in the flow of cool air from the indoor unit.

4-Way Cassette Type



HOW TO INSTALL THE INDOOR UNIT

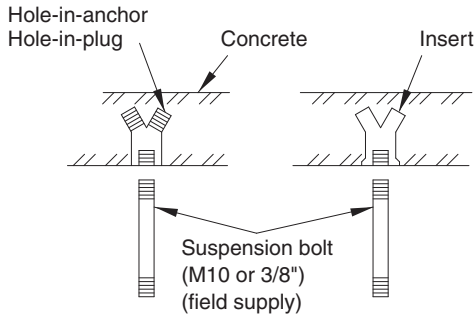
Preparation for Suspending

This unit uses a drain pump. Use a carpenter's level to check that the unit is level.

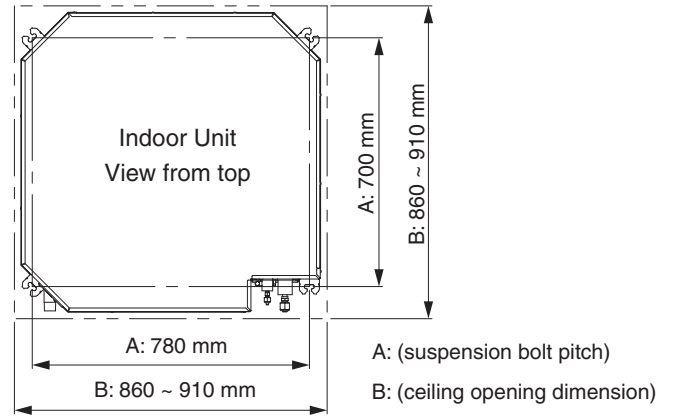
Note: For DC Fan Tap Change Procedure for 4-Way Cassette, see page 1-12-2-2-13.

Suspending the Indoor Unit

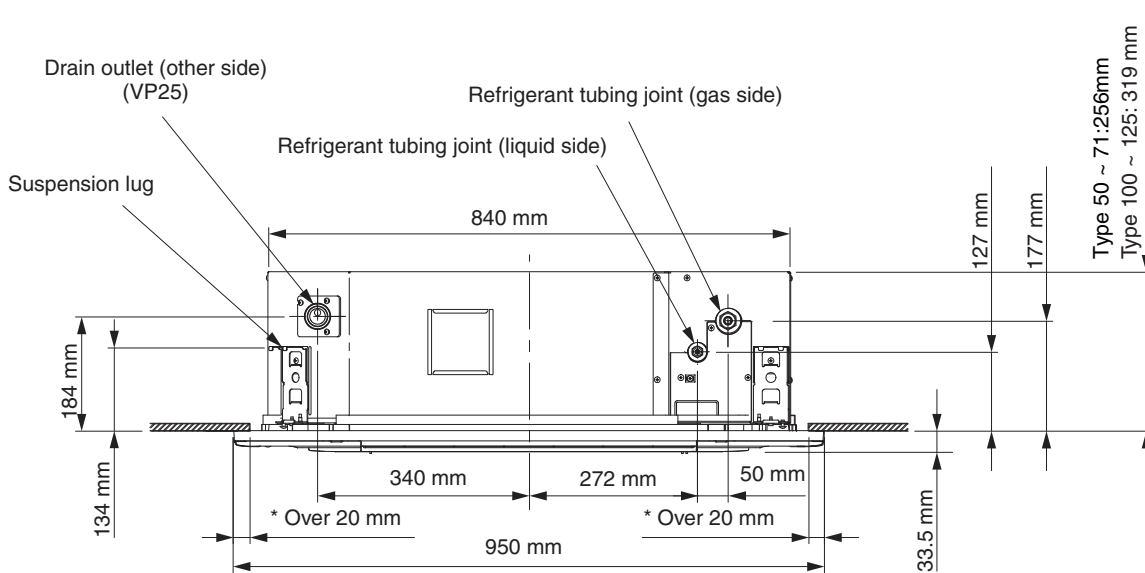
(1) Fix the suspension bolts securely in the ceiling using the method shown in the diagrams, by attaching them to the ceiling support structure, or by any other method that ensures that the unit will be securely and safely suspended.



(2) Follow the diagram to make the holes in the ceiling.



(3) Determine the pitch of the suspension bolts using the supplied full-scale installation diagram (printed on container box). The diagram show the relationship between the positions of the suspension fitting, unit, and panel. Use the nut (field supply) and washer (supplied) for upper and lower position of the suspension lug.



* The overlapping portion between the ceiling and panel for cassette should be kept over 20 mm.

Placing the Unit Inside the Ceiling

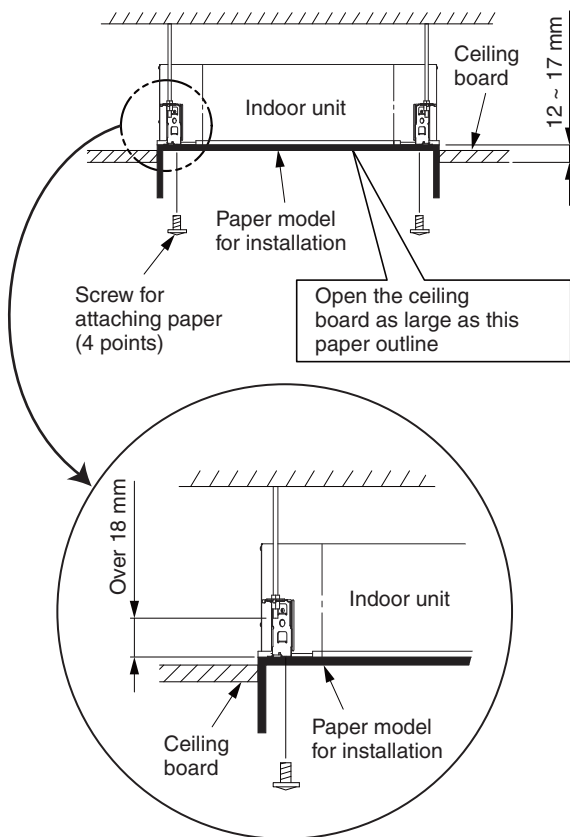
This unit is equipped with the drain pump. Check a tape measure or carpenter's level.

Before installing the panel for cassette, complete the work of drain pipe and refrigerant pipe installation.

- (1) When placing the unit inside the ceiling, determine the pitch of the suspension bolts using the supplied full-scale installation diagram.

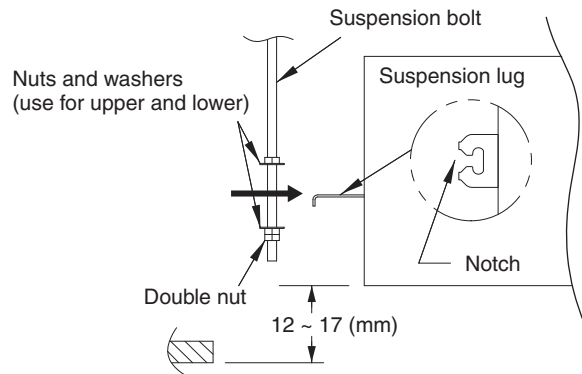
Tubing and wiring must be laid inside the ceiling when suspending the unit. If the ceiling is already constructed, lay the tubing and wiring into position for connection to the unit before placing the unit inside the ceiling.

- (2) The length of suspension bolts must be appropriate for a distance between the bottom of the bolt and the bottom of the unit of more than 18 mm.



Full-scale installation diagram
(printed on top of container box)

- (3) Thread the 3 hexagonal nuts and 2 washers onto each of the 4 suspension bolts. Use 1 nut and 1 washer for the upper side, and 2 nuts and 1 washer for the lower side, so that the unit will not fall off the suspension lugs.



- (4) Adjust so that the distance between the unit and the ceiling bottom is 12 to 17 mm. Tighten the nuts on the upper side and lower side of the suspension lug.
- (5) Remove the protective polyethylene used to protect the fan parts during transport.
- (6) Check with a tape measure or carpenter's level.

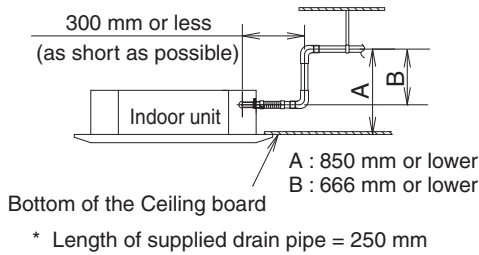
Installing the Drain Pipe

Before Performing the Installation Drain Piping

(1) Limitations of Raising the Drain Pipe Connection



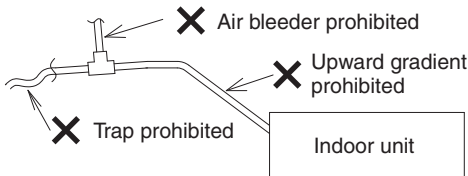
- The drain pipe can be raised to a maximum height of 850 mm from the bottom of the ceiling. Do not attempt to raise it higher than 850 mm. Doing so will result in water leakage.



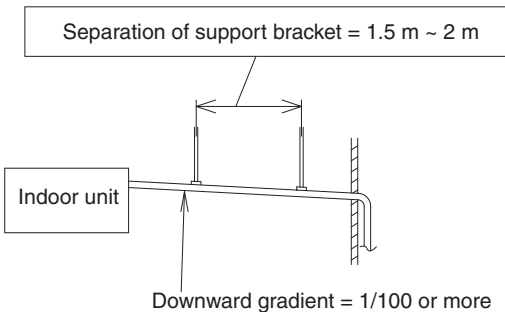
(2) Limitations of Drain Pipe Connection



- Do not install the drain pipe with an upward gradient from the drain port connection. This will cause the drain water to flow backward and leak when the unit is not operating.
- Do not install an air bleeder as this may cause water to spray from the drain pipe outlet.
- Do not provide U-trap or bell-shaped trap in the middle of the drain pipe. Doing so will cause abnormal sound.



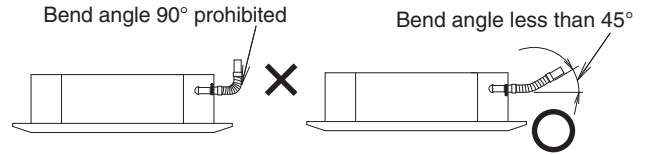
- Make sure the drain pipe has a downward gradient (1/100 or more; downward from drain port connection).



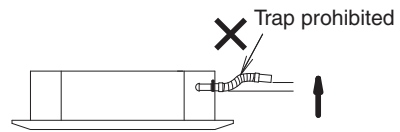
(3) Limitations of Drain Hose Connection



- Do not bend the supplied drain hose 90° or more. Bend it less than 45°.



- Do not make a trap in the middle of the supplied drain hose. Doing so will cause abnormal sound.



Installing the Drain Pipe



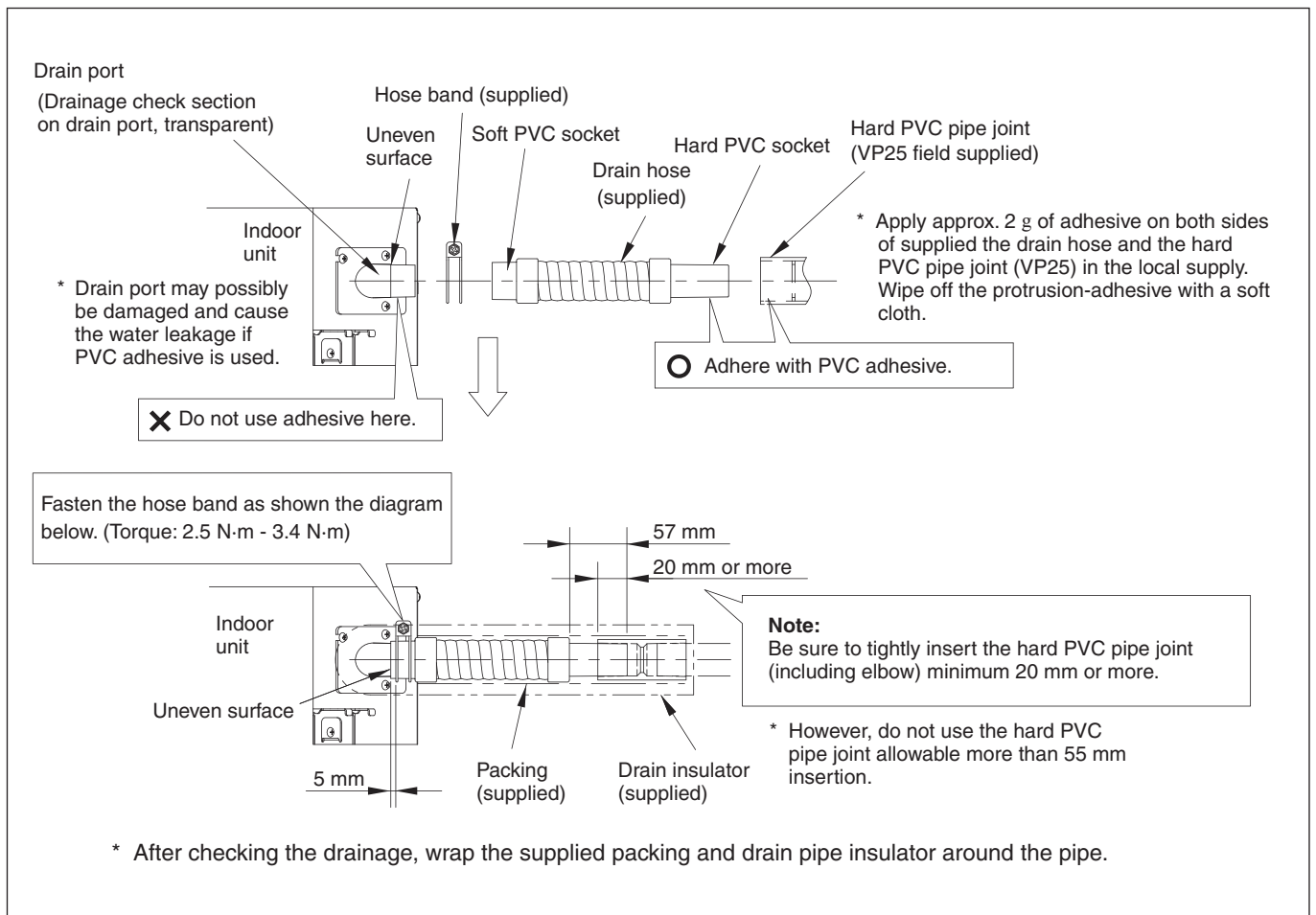
CAUTION

- Do not apply force to the drain port when connecting the drain pipe. Install and fix it near the indoor unit as close as possible.
- Do not use adhesive when connecting the drain port pipe and the drain hose.

(1) How to Install the Drain Pipe

- 1) First insert the supplied hose band into the drain port pipe. Then make sure the head of the screw is facing toward a technical engineer when placing the screw of the hose band at an upward angle.
- 2) Insert the soft PVC socket of the supplied drain hose to the drain port pipe. Do not use adhesive when connecting the drain hose to the drain port pipe. Insert it until the tip of the drain hose contacts the uneven surface of the drain port pipe.

- 3) Move the hose band so that the center position of the hose band can be placed approx. 30 mm away from the external plate of the indoor unit. See diagram below.
- 4) Screw the drain hose tightly facing the screw of the hose band upward. (Torque: 2.5 N·m - 3.4 N·m) (If the screw is tightened beneath the drain hose, the troubles will be generated.)
- 5) Apply approx. 2 g of adhesive on both sides of the drain hose without connection of the hard PVC socket and the hard PVC pipe joint (VP25) in the local supply.
- 6) Connect the drain hose and the hard PVC pipe joint so that the adhesive area of both sides can be overlapped. Wipe off the protrusion-adhesive with a soft cloth.



Checking the Drainage

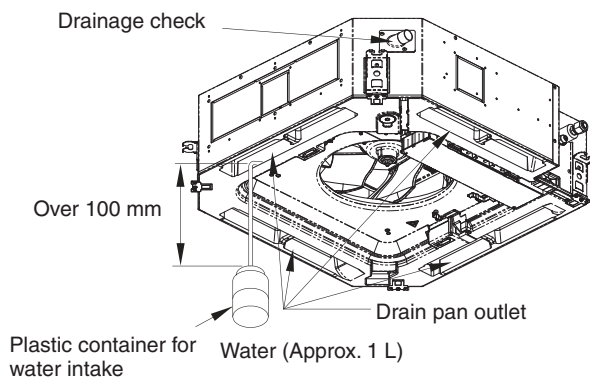


CAUTION

Be careful since the fan will start when you short the pin on the indoor control board.

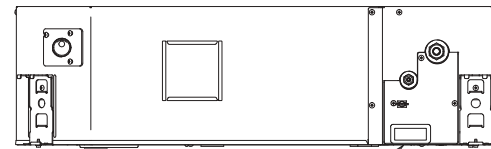
After wiring (See the “1-11. ELECTRICAL WIRING”.) and drain piping are completed, use the following procedure to check that the water will drain smoothly. For this, prepare a bucket and wiping cloth to catch and wipe up spilled water.

- (1) Connect power to the power terminal board (L, N terminals) inside the electrical component box.
- (2) Slowly pour about 1 L of water into the drain pan to check drainage.



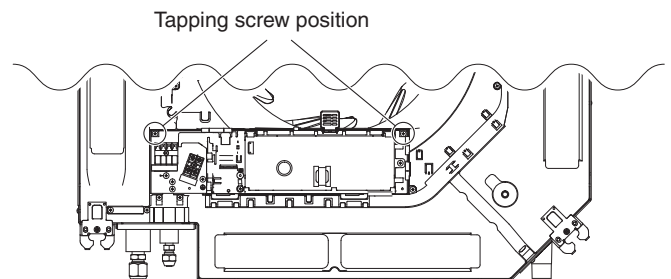
- (3) Short the check pin (CHK) (6P : 5-6) on the indoor control board and operate the drain pump. Check the water flow through the transparent drain pipe and see if there is any leakage.
 - * If the check pin (CHK) (6P:5-6) is shorted, the fan starts rotating at high speed and could cause injury.
- (4) When the check of drainage is complete, open the check pin (CHK) (6P : 5-6) and remount the tube cover.
- (5) Checkpoint after installation
After installation of indoor and outdoor units, panels and electrical wiring, check the following items.

Important Note for Wiring 4-Way Cassette Type



Power supply inlet

- (1) The power supply inlet is located at the lower area of the refrigerant tubing side of the unit. The electrical component box is located at the air intake of the bottom of the unit.
- (2) Before installing the panel for cassette, be sure to carry out the wiring connection.
- (3) Remove the lid located on the bottom of the indoor unit attaching the electrical component box by unscrewing the Phillips head tapping screws (x2).



Tapping screw position

- (4) Lead the wires from the power supply inlet to the unit. Be sure to lead the wires through the power supply inlet. Make sure that no wire is caught between the indoor unit and panel for cassette. Otherwise, the unit may cause a fire.
- (5) Connect the wires into the terminals through the power supply inlet for the electrical component box. Fix the wires with a clamping clip.
- (6) Reinstall the lid of the electrical component box in its original position with paying attention not to have the wires caught in the lid.
See the “1-11. ELECTRICAL WIRING”.

HOW TO PROCESS TUBING

Must ensure mechanical connections be accessible for maintenance purposes.

Connecting the Refrigerant Tubing

NOTE

When connecting flare at indoor side, make sure that the flare connection is used only once. If torqued up and released, the flare must be remade. Once the flare connection was torqued up correctly and leak test was made, thoroughly clean and dry the surface to remove oil, dirt and grease by following instructions of silicone sealant. Apply neutral cure & ammonia-free silicone sealant that is non-corrosive to copper & brass to the external of the flared connection to prevent the ingress of moisture on both the gas & liquid sides. (Moisture may cause freezing and premature failure of the connection.)

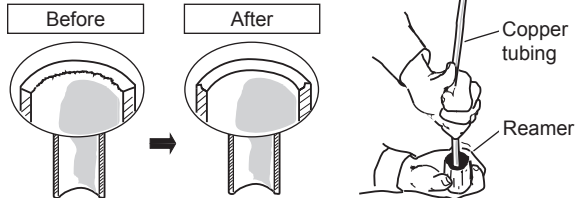
Use of the Flaring Method

Many of conventional split system air conditioners employ the flaring method to connect refrigerant tubes that run between indoor and outdoor units. In this method, the copper tubes are flared at each end and connected with flare nuts.

Flaring Procedure with a Flare Tool

- (1) Cut the copper tube to the required length with a tube cutter. It is recommended to cut approx. 30 – 50 cm longer than the tubing length you estimate.
- (2) Remove burrs at each end of the copper tubing with a tube reamer or a similar tool. This process is important and should be done carefully to make a good flare. Be sure to keep any contaminants (moisture, dirt, metal filings, etc.) from entering the tubing.

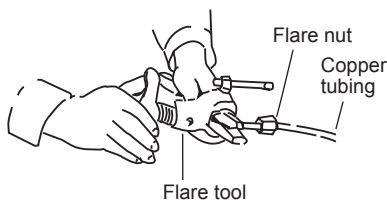
Deburring



NOTE

When reaming, hold the tube end downward and be sure that no copper scraps fall into the tube.

- (3) Remove the flare nut from the unit and be sure to mount it on the copper tube.
- (4) Make a flare at the end of the copper tube with a flare tool.



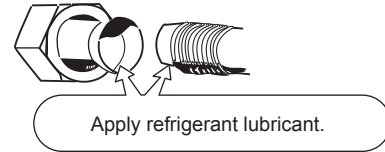
NOTE

When flared joints are reused, the flare part shall be re-fabricated. A good flare should have the following characteristics:

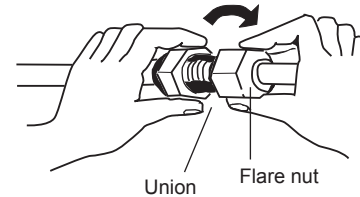
- inside surface is glossy and smooth
- edge is smooth
- tapered sides are of uniform length

Caution Before Connecting Tubes Tightly

- (1) Apply a sealing cap or water-proof tape to prevent dust or water from entering the tubes before they are used.
- (2) Be sure to apply refrigerant lubricant (ether oil) to the inside of the flare nut before making piping connections. This is effective for reducing gas leaks.



- (3) For proper connection, align the union tube and flare tube straight with each other, then screw on the flare nut lightly at first to obtain a smooth match.



- Adjust the shape of the liquid tube using a tube bender at the installation site and connect it to the liquid tubing side valve using a flare.

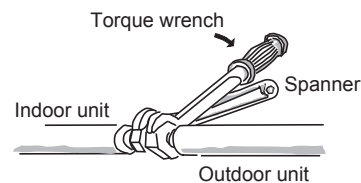
Connecting Tubing Between Indoor and Outdoor Units

- (1) Tightly connect the indoor-side refrigerant tubing extended from the wall with the outdoor-side tubing.

Indoor Unit Tubing Connection ($l_1, l_2 \dots l_{n-1}$)

Indoor unit type	50	60	71	100	125
Gas tubing (mm)	ø12.7			ø15.88	
Liquid tubing (mm)	ø6.35			ø9.52	

- (2) To fasten the flare nuts, apply specified torque.
- When removing the flare nuts from the tubing connections, or when tightening them after connecting the tubing, be sure to use a torque wrench and a spanner. If the flare nuts are over-tightened, the flare may be damaged, which could result in refrigerant leakage and cause injury or asphyxiation to room occupants.



- For the flare nuts at tubing connections, be sure to use the flare nuts that were supplied with the unit, or else flare nuts for R410A, R32 (type 2). The refrigerant tubing that is used must be of the correct wall thickness as shown in the table below.

Tube diameter	Tightening torque (approximate)	Tube thickness
ø6.35 (1/4")	14 – 18 N · m {140 – 180 kgf · cm}	0.8 mm
ø9.52 (3/8")	34 – 42 N · m {340 – 420 kgf · cm}	0.8 mm
ø12.7 (1/2")	49 – 55 N · m {490 – 550 kgf · cm}	0.8 mm
ø15.88 (5/8")	68 – 82 N · m {680 – 820 kgf · cm}	1.0 mm

Because the pressure is approximately 1.6 times higher than conventional refrigerant R22 pressure, the use of ordinary flare nuts (type 1) or thin-walled tubes may result in tube rupture, injury, or asphyxiation caused by refrigerant leakage.

- In order to prevent damage to the flare caused by over-tightening of the flare nuts, use the table above as a guide when tightening.
- When tightening the flare nut on the liquid tube, use an adjustable wrench with a nominal handle length of 200 mm.

Insulating the Refrigerant Tubing

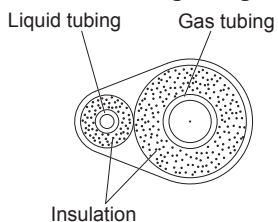
Tubing Insulation

Must ensure that pipe-work shall be protected from physical damage.

- Thermal insulation must be applied to all units tubing, including distribution joint (field supply).
 - * For gas tubing, the insulation material must be heat resistant to 120°C or above. For other tubing, it must be heat resistant to 80°C or above.

Insulation material thickness must be 10 mm or greater. If the conditions inside the ceiling exceed DB 30°C and RH 70%, increase the thickness of the gas tubing insulation material by 1 step.

Two tubes arranged together



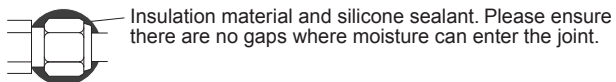
CAUTION

If the exterior of the outdoor unit valves has been finished with a square duct covering, make sure you allow sufficient space to access the valves and to allow the panels to be attached and removed.

Additional Precautions For R32 Models.

! Ensure to do the re-flaring of pipes before connecting to units to avoid leaking.

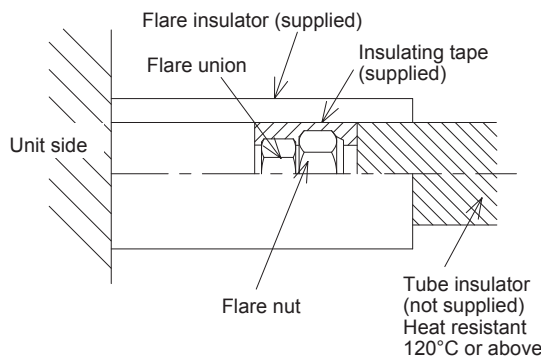
To prevent the ingress of moisture into the joint which could have the potential to freeze and then cause leakage, the joint must be sealed with suitable silicone and insulation material. The joint should be sealed on both liquid and gas side.



Silicone Sealant must be neutral cure and ammonia free. Use of silicon containing ammonia can lead to stress corrosion on the joint and cause leakage.

Taping the flare nuts

Wind the white insulating tape around the flare nuts at the gas tube connections. Then cover up the tubing connections with the flare insulator, and fill the gap at the union with the supplied black insulating tape. Finally, fasten the insulator at both ends with the supplied vinyl clamps.



Insulation material

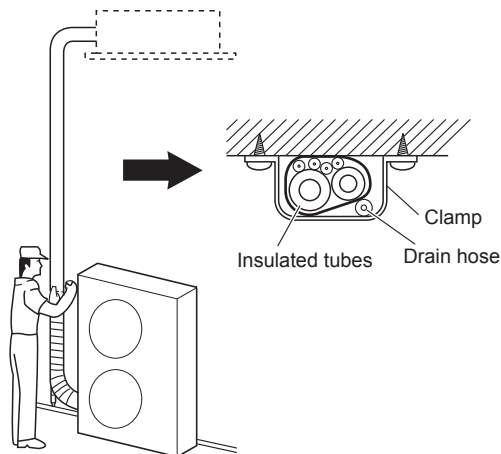
The material used for insulation must have good insulation characteristics, be easy to use, be age resistant, and must not easily absorb moisture.

CAUTION

After a tube has been insulated, never try to bend it into a narrow curve because it can cause the tube to break or crack. Never grasp the drain or refrigerant connecting outlets when moving the unit.

Taping the Tubes

- (1) At this time, the refrigerant tubes (and electrical wiring if local codes permit) should be taped together with armoring tape in 1 bundle. To prevent condensation from overflowing the drain pan, keep the drain hose separate from the refrigerant tubing.
- (2) Wrap the armoring tape from the bottom of the outdoor unit to the top of the tubing where it enters the wall. As you wrap the tubing, overlap half of each previous tape turn.
- (3) Clamp the tubing bundle to the wall, using 1 clamp approx. each meter.

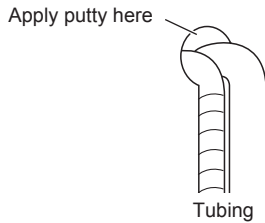


NOTE

Do not wind the armoring tape too tightly since this will decrease the heat insulation effect. Also ensure that the condensation drain hose splits away from the bundle and drips clear of the unit and the tubing.

Finishing the Installation

After finishing insulating and taping over the tubing, use sealing putty to seal off the hole in the wall to prevent rain and draft from entering.



■ HOW TO INSTALL THE TIMER REMOTE CONTROLLER OR HIGH-SPEC WIRED REMOTE CONTROLLER (OPTIONAL PART)

NOTE

See "Section 2. TEST RUN".

Accessories Supplied with Unit

(4-Way Cassette)

Part Name	Figure	Q'ty	Remarks
Full-scale installation diagram		1	Printed on container box
Washer		8	For suspension bolts
Screw		4	For full-scale installation diagram
Insulating tape		2	For gas and liquid tube flare nuts
Flare insulator		1	For liquid tube
Flare insulator		1	For gas tube
Drain hose		1	
Hose band		1	For securing drain hose

Part Name	Figure	Q'ty	Remarks
Packing		1	
Drain insulator		1	
Clamper		4	For electrical wiring
Operating Instructions		1	
Installation Instructions		1	

- Use M10 for suspension bolts.
- Field supply for suspension bolts and nuts.

Type of Copper Tube and Insulation Material

If you wish to purchase these materials separately from a local source, you will need:

1. Deoxidized annealed copper tube for refrigerant tubing.
2. Foamed polyethylene insulation for copper tubes as required to precise length of tubing. Wall thickness of the insulation should be not less than 8 mm.
3. Use insulated copper wire for field wiring. Wire size varies with the total length of wiring. See the section "1-11. ELECTRICAL WIRING" for details.



CAUTION

Check local electrical codes and regulations before obtaining wire. Also, check any specified instructions or limitations.

Additional Materials Required for Installation

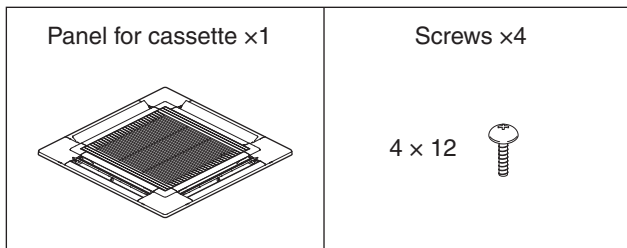
1. Refrigeration (armored) tape
2. Insulated staples or clamps for connecting wire (See your local codes.)
3. Putty
4. Refrigeration tubing lubricant
5. Clamps or saddles to secure refrigerant tubing
6. Scale for weighing

■ HOW TO INSTALL THE CEILING PANEL

4-Way Cassette Type (Type U2)

CZ-KPU3

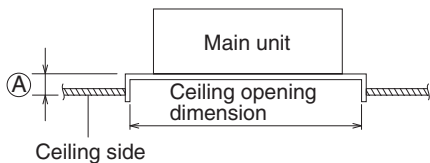
Accessories



Preparation for Panel for Cassette Installation

(1) Checking the unit position

- 1) Check that the ceiling hole is within this range:
860 mm × 860 mm to 910 mm × 910 mm
- 2) Confirm that the position of the indoor unit and the ceiling as shown in the diagram. If the positions of the ceiling surface and unit do not match, air leakage, water leakage, flap operation failure, or other problems may occur.

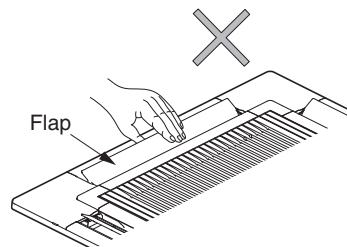


Ⓐ : Be sure to necessarily make a space within the range of 12 mm ~ 17 mm.

If not within this range, malfunction or other trouble may occur.



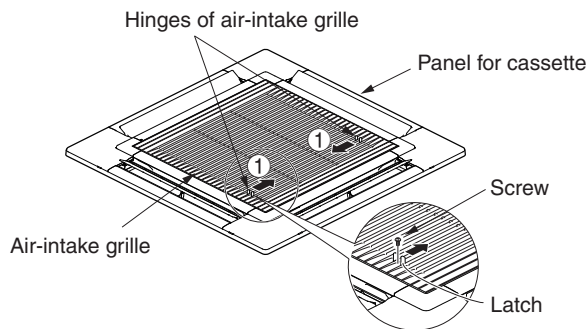
- Never place the panel face-down. Either hang it vertically or place it on top of a projecting object. Placing it face-down will damage the surface.
- Do not touch the flap or apply force to it. (This may cause flap malfunction.)



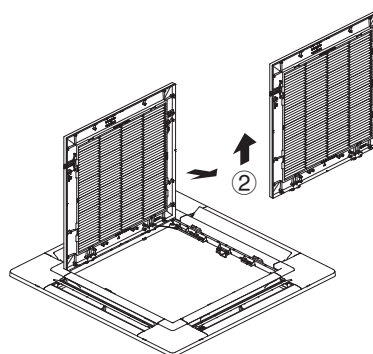
How to Install the Panel for Cassette

(1) Removing the air-intake grille

- 1) Remove the 2 screws on the latch of the air-intake grille. (Reattach the air-intake grille after installation of the panel for cassette.)
- 2) Slide the air-intake grille catches in the direction shown by the arrows ① to open the grille.

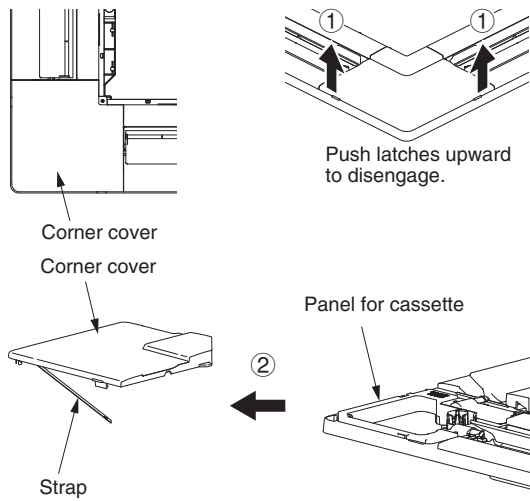


- 3) With the air-intake grille opened, remove the grille hinge from the panel for cassette by sliding it in the direction shown by the arrow ②. (Reattach the air-intake grille after installation of the panel for cassette.)



(2) Removing the corner cover

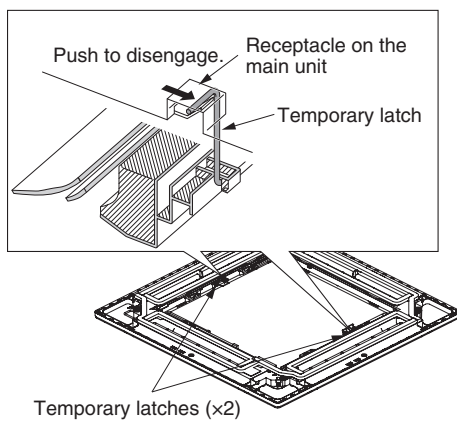
Push the latches on the corner cover in the direction of the arrow ① and remove them by sliding in the direction of the arrow ②.



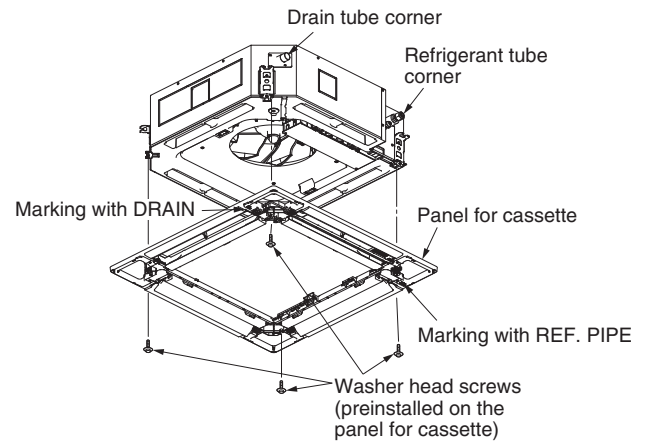
(3) Installing the panel for cassette

The power must be turned ON in order to change the flap angle. (Do not attempt to move the flap by hand. Doing so may damage the flap.)

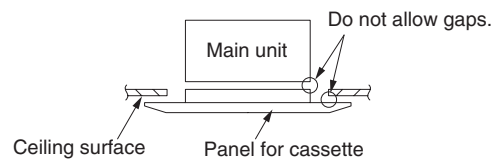
- 1) Hang the temporary latches on the inside of the panel for cassette to the receptacle on the unit to temporarily attach the panel for cassette in place.
 - The panel for cassette must be installed in the correct direction relative to the unit. Align the REF. PIPE and DRAIN marks on the panel for cassette corner with the correct positions on the unit.
 - When removing the panel for cassette, push the temporary latches outward while holding the panel for cassette.



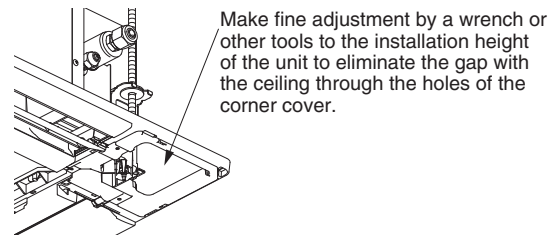
- 2) Align the panel installation holes and the unit screw holes.
- 3) Tighten the provided washer head screws at the 4 panel installation locations so that the panel is attached tightly to the unit.



- 4) Check that the panel is attached tightly to the ceiling.
 - At this time, make sure that there are no gaps between the unit and the panel for cassette, or between the panel for cassette and the ceiling surface.

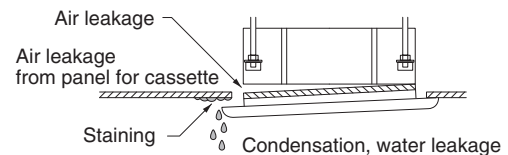


- If there is a gap between the panel and the ceiling, leave the panel for cassette attached and make fine adjustments to the installation height of the unit to eliminate the gap with the ceiling.

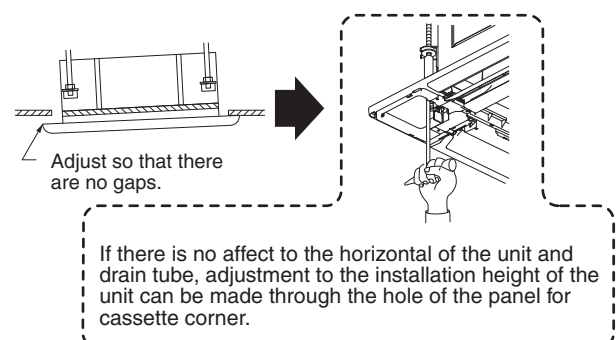


CAUTION

- If the screws are not sufficiently tightened, trouble such as that shown in the figure below may occur. Be sure to tighten the screws securely.

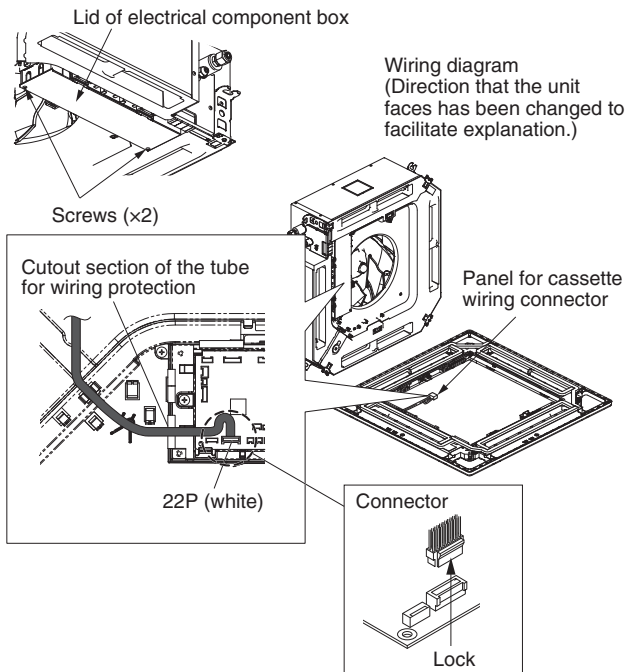


- If a gap remains between the ceiling surface and the panel for cassette even after the screws are tightened, adjust the height of the unit again.



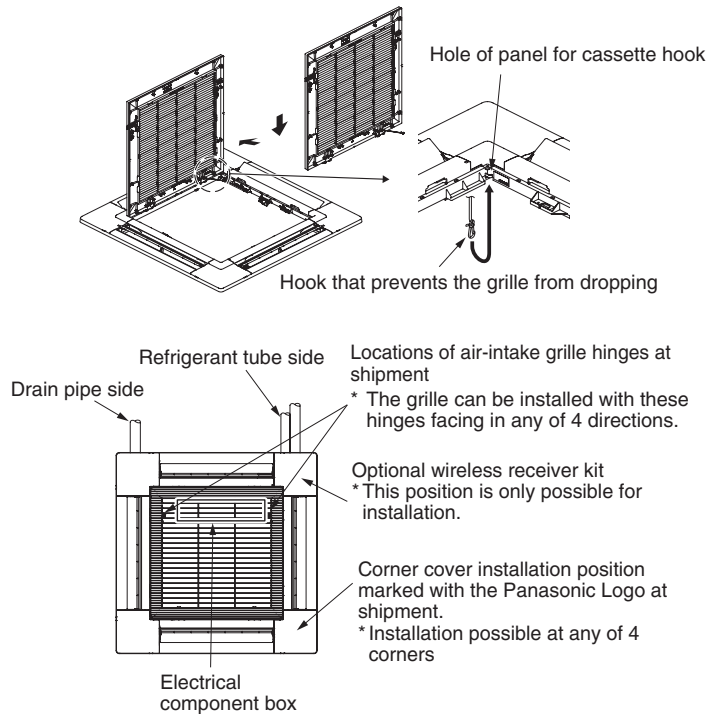
(4) Wiring the Panel for Cassette

- 1) Open the cover of the electrical component box for control PCB.
 - 2) Connect the 22P connector (white) from the panel for cassette to the connector on the control PCB in the unit electrical component box. In this case, expose the cutout section of the tube for the wiring protection to the outside from the electrical component box and fix it with the clamer attached to the electrical component box.
- **Insert connector lock facing PCB edge until it is locked in place. (If not connected completely, the Auto Flap will not operate and “P09” is displayed on the remote controller. When the connector plugged in the wrong direction, parts on the PCB may be damaged.)**
 - **Check that the wiring connector is not caught between the electrical component box and the cover.**
 - **Check that the wiring connector is not caught between the unit and the panel for cassette.**



B. Attaching the air-intake grille

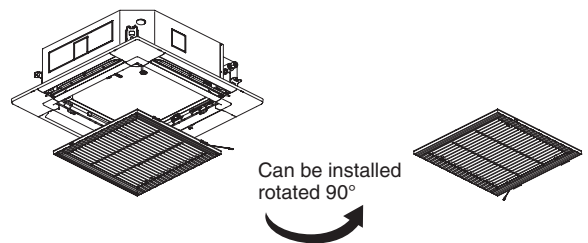
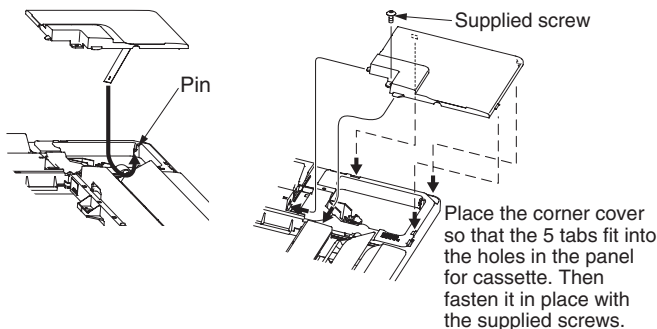
- To install the air-intake grille, follow the steps for “Removing the grille” in the reverse order. By rotating the air-intake grille, it is possible to attach the grille onto the panel for cassette from any of 4 directions. Coordinate the directions of the air-intake grilles when installing multiple units, and change the directions according to customer’s requests.
- When attaching the air-intake grille, be careful that the flap lead wire does not become caught.
- Be sure to attach the safety cord that prevents the air-intake grille from dropping off to the panel for cassette unit as shown in the figure below.
- With this panel for cassette, the directions of the air-intake grille lattices when installing multiple units, and the position of the label showing the company name on the corner panel, can be changed according to customer’s requests, as shown in the figure below. However, the wireless signal receiver can only be installed at the refrigerant-tubing corner of the ceiling unit.



(5) How to Attach the Corner & Air-Intake Grille

A. Attaching the corner cover

- 1) Check that the safety cord from the corner cover is fastened to the panel for cassette pin, as shown in the figure below.
- 2) Use the supplied screws to attach the corner cover to the panel for cassette.



■ Others

(1) Checking After Installation

1) Check that there are no gaps between the unit and the panel for cassette, or between the panel for cassette and the ceiling surface.

* Gaps may cause water leakage and condensation.

2) Check that the wiring is securely connected.

* If it is not securely connected, the auto flap will not operate.

("P09" is displayed on the remote controller.)

In addition, the water leakage and condensation may occur.

(2) Operating the Wireless Remote Controller

For details of installation, refer to the section "Wireless Signal Receiver" in the supplied installation instructions.

(3) Selecting DC Fan Motor Tap (4-Way Cassette)

Check the optional parts accordingly in the following table.

Table for DC Fan Motor Tap Settings

Setting No.	Remote controller setting data Item code 5d	Contents & optional parts name
(1)	0001	Air-flow blocking kit (for 3-way air flow)*2
		Air-flow blocking kit (when a duct is connected.)
		High-ceiling setting 1*2
(3)	0003	High-ceiling setting 2*2
(6)	0006	Air-flow blocking kit (for 2-way air flow)*2

*1 When using optional parts in different setting No. in combination with multiple units, conform it to the larger setting No.

*2 Ceiling height (m)

Indoor unit type	50	60, 71	100, 125
Standard (factory setting)	2.7	3.0	3.6
High-ceiling setting 1	3.2	3.3	4.3
High-ceiling setting 2	3.5	3.6	5.0
Air-flow blocking kit (for 3-way air flow)	3.8	3.8	4.7
Air-flow blocking kit (for 2-way air flow)	4.2	4.2	5.0

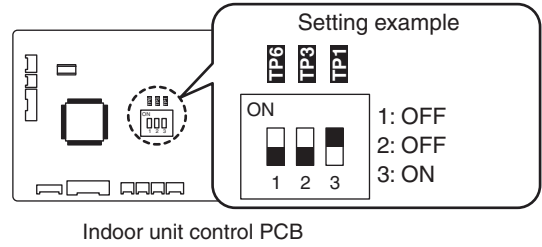
1) When setting on the P.C. Board

<Procedure>

Stop the system before performing these steps.

- ① Open the electrical component box cover, then check the indoor unit control PCB.
- ② Change the DIP switch on the indoor unit control PCB in accordance with the setting number which was confirmed in Table for DC Fan Motor Tap Settings.

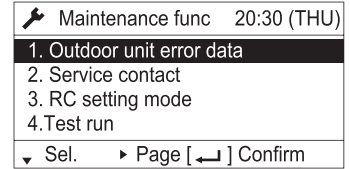
Setting No.	DIP switch	Setting No.	DIP switch
(1)		(6)	
(3)			



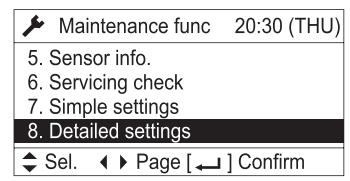
<Procedure of CZ-RTC5B>

Stop the system before performing these steps.

- ① Keep pressing the , and buttons simultaneously for 4 or more seconds. The "Maintenance func" screen appears on the LCD display.



- ② Press the or button to see each menu. If you wish to see the next screen instantly, press the or button. Select "8. Detailed settings" on the LCD display and press the button.

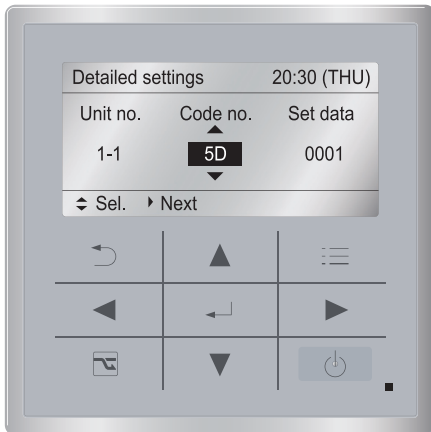


The "Detailed settings" screen appears on the LCD display.

- ③ Select the "Unit no." by pressing the or button for changes.

Detailed settings		20:30 (THU)
Unit no.	Code no.	Set data
1-1	10	0001
Sel.		Next

- ④ Select the "Code no." by pressing the or button.
Change the "Code no." to "5D" by pressing the or button (or keeping it pressed).

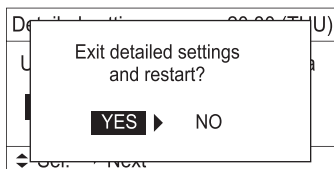


- ⑤ Select the "Set data" by pressing the or button.
Select one of the "Set data" in "Table for DC Fan Motor Tap Settings" by pressing the or button.

Then press the button.

Detailed settings		20:30 (THU)
Unit no.	Code no.	Set data
1-1	5D	0003
Sel.		[confirm] Confirm

- ⑥ Press the button.
The "Exit detailed settings and restart?" (Detailed setting-end) screen appears on the LCD display.
Select "YES" and press the button.

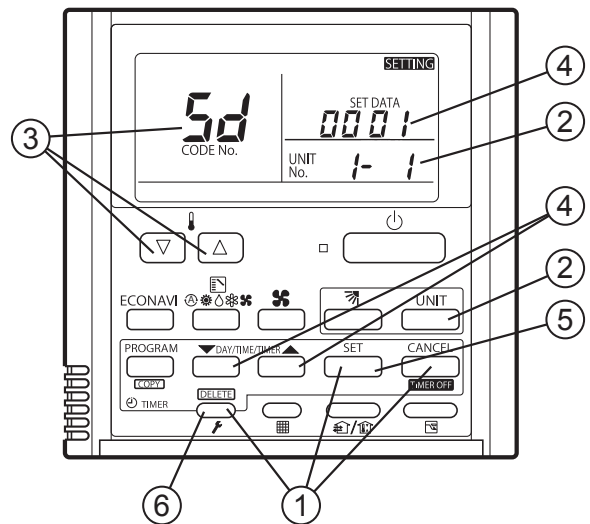


If you wish to change the selected indoor unit, follow the step ②.

<Procedure of CZ-RTC4>

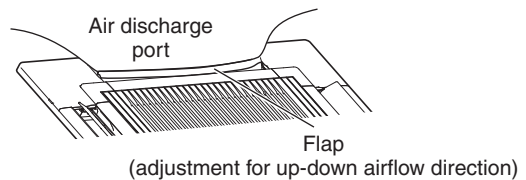
Stop the system before performing these steps.

- ① Press and hold the , , and buttons simultaneously for 4 seconds or longer.
- ② If group control is in effect, press the button to set. At this time, the fan at the indoor unit begins and select the address (unit No.) of the indoor unit operating.
- ③ Designate the item code **5d** by adjusting the Temperature Setting / buttons.
- ④ Press the timer time buttons to select the desired setting data.
*For item codes and setting data, see the "Table for DC Fan Motor Tap Settings".
- ⑤ Press the button.
(The display stops blinking and remains lit, and setting is completed.)
If you wish to change the selected indoor unit, follow the step ②.
- ⑥ Press the button to return to normal remote controller display.



(4) Setting the Flap Separately

- 1) The 4-air outlet flap can be adjusted separately during operation. When not adjusted separately, all flaps operate in the same manner.

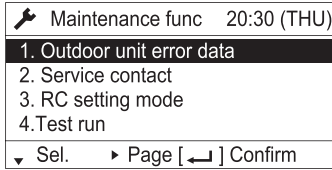


<Procedure of CZ-RTC5B>

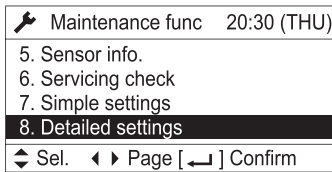
Stop the system before performing these steps.

- (1) Keep pressing the and buttons simultaneously for 4 or more seconds.

The "Maintenance func" screen appears on the LCD display.

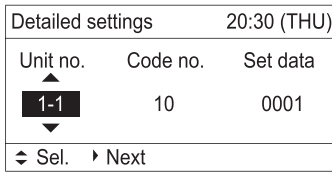


- (2) Press the or button to see each menu. If you wish to see the next screen instantly, press the or button. Select "8. Detailed settings" on the LCD display and press the button.

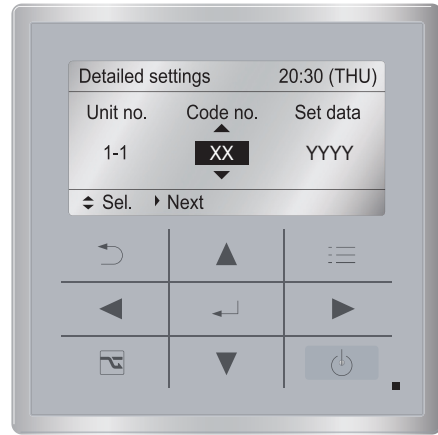
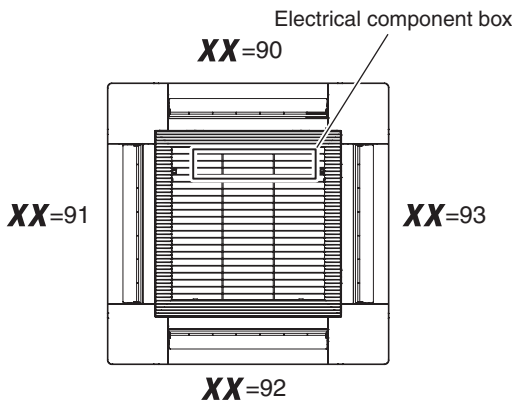


The "Detailed settings" screen appears on the LCD display.

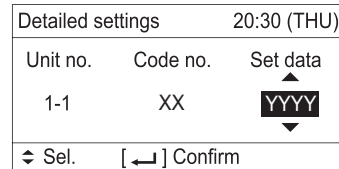
- (3) Select the "Unit no." by pressing the or button for changes.



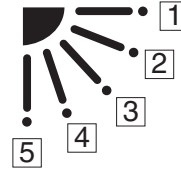
- (4) Select the "Code no." by pressing the or button. Change the "Code no." to "XX" by pressing the or button (or keeping it pressed).



- (5) Select the "Set data" by pressing the or button. Select one of the Setting Data "YYYY" by pressing the or button. Then press the button.



Flap position



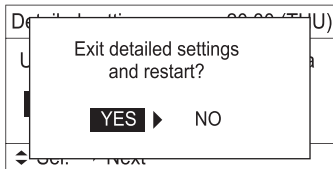
* Setting data "YYYY"

Setting data	Flap position during operation
0000	Without separate setting
0001	Swing
0002	Move to position 1 and stay
0003	Move to position 2 and stay
0004	Move to position 3 and stay
0005	Move to position 4 and stay
0006	Move to position 5 and stay

NOTE

The flap swings during the operation under "Setting the Flap Separately". At this time, the unselected flaps are moved to the position 1.

- (6) Press the button. The "Exit detailed settings and restart?" (Detailed setting-end) screen appears on the LCD display. Select "YES" and press the button.

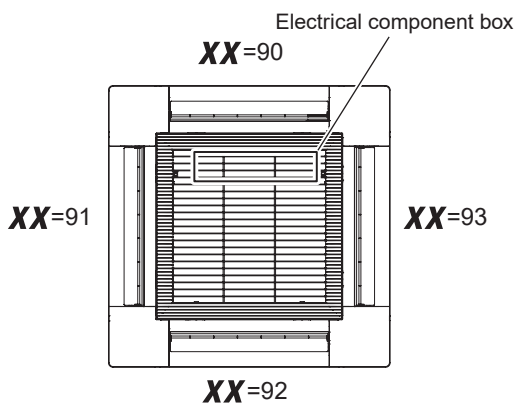


If you wish to change the selected indoor unit, follow the step (2).

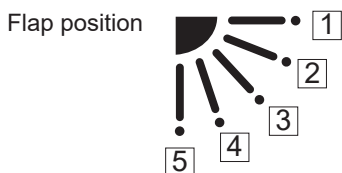
<Procedure of CZ-RTC4>

Stop the system before performing these steps.

- (1) Press and hold the , and buttons simultaneously for 4 seconds or longer.
- (2) If group control is in effect, press the button to set. At this time, the fan at the indoor unit begins and select the address (unit No.) of the indoor unit operating.
- (3) Designate the item code "XX" by adjusting the Temperature Setting / buttons.



- (4) Press the timer time buttons to select the desired setting data.



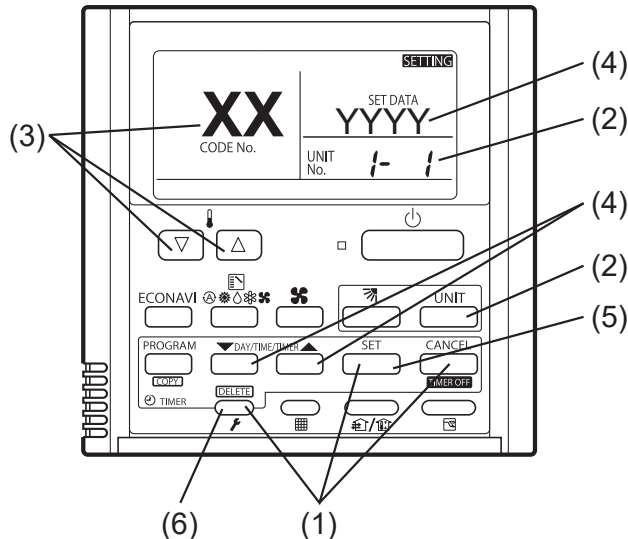
* Setting data "YYYY"

Setting data	Flap position during operation
0000	Without separate setting
0001	Swing
0002	Move to position 1 and stay
0003	Move to position 2 and stay
0004	Move to position 3 and stay
0005	Move to position 4 and stay
0006	Move to position 5 and stay

NOTE

The flap swings during the operation under "Setting the Flap Separately".
At this time, the unselected flaps are moved to the position 1.

- (5) Press the button.
(The display stops blinking and remains lit, and setting is completed.)
If you wish to change the selected indoor unit, follow the step (2).
- (6) Press the button to return to normal remote controller display.



■ HOW TO INSTALL WIRELESS REMOTE CONTROLLER

NOTE

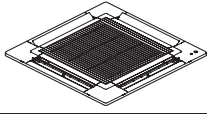



Refer to the Installation Instructions attached to the optional Wireless Remote Controller.

■ Panel for Cassette (ECONAVI type)

CZ-KPU3A

Applicable indoor unit : 4-Way Cassette

Accessories Supplied

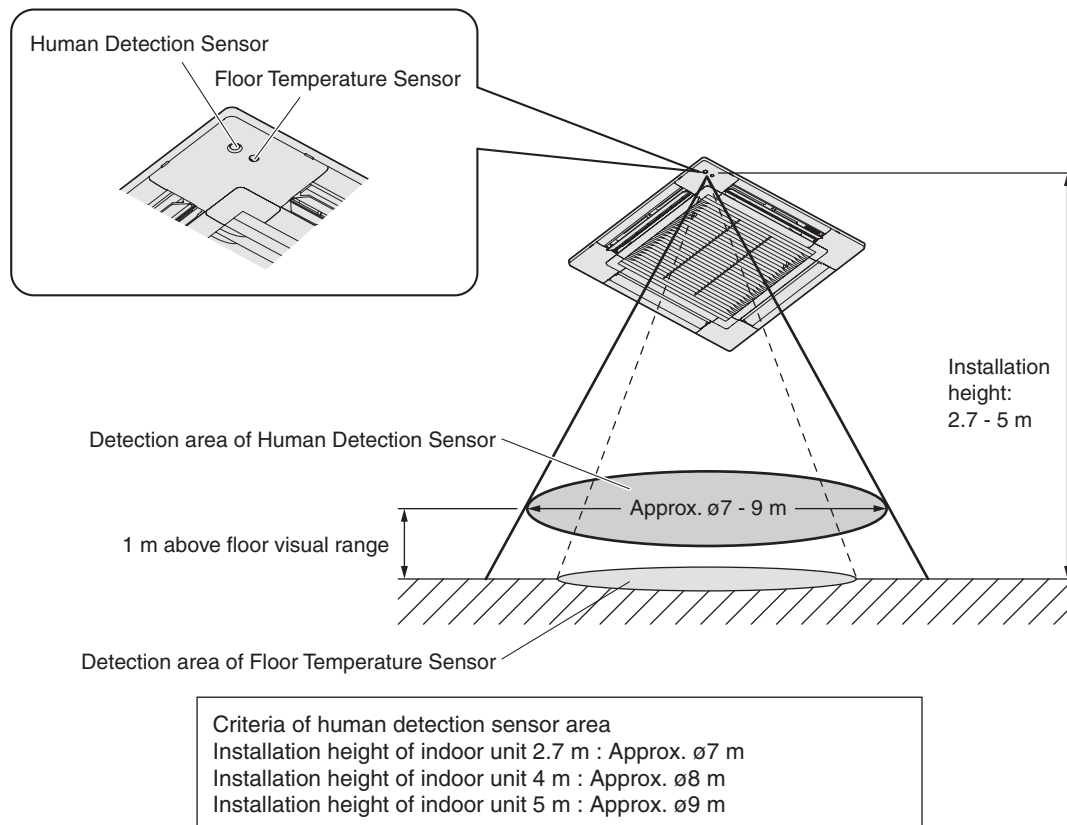
Part Name	Figure	Q'ty	Remarks
ECONAVI panel		1	ECONAVI type
Screw		4	4 x 12
Operating Instructions		1	
Installation Instructions		1	

Since the accessories need for installation work, do not dispose of them until the unit of work is complete.

■ CAUTION ON INSTALLATION

Criteria for Human Detection Area

- A place where the blind angle of the Human Detection Sensor cannot detect human.
Install the panel for cassette (ECONAVI type) so that human motion can be detected.
- If there is a heat source or cooling unit in the detection area, the sensor cannot occasionally detect properly.
- The Floor Temperature Sensor detects within the sensor area of Human Detection Sensor.



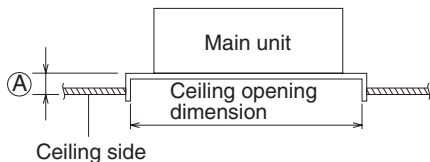
Do not install at the following locations. (Cause of trouble and malfunction)

- Humid, oily, frequent vibration
- Direct sunlight and near by heat source
- Frost

Preparation for Panel for Cassette Installation

(1) Checking the unit position

- 1) Check that the ceiling hole is within this range:
860 × 860 mm to 910 × 910 mm
- 2) Confirm that the position of the indoor unit and the ceiling as shown in the diagram. If the positions of the ceiling surface and unit do not match, air leakage, water leakage, flap operation failure, or other problems may occur.



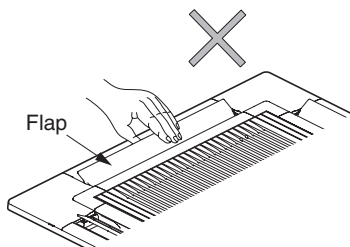
Ⓐ : Be sure to necessarily make a space within the range of 12 ~ 17 mm.

If not within this range, malfunction or other trouble may occur.



CAUTION

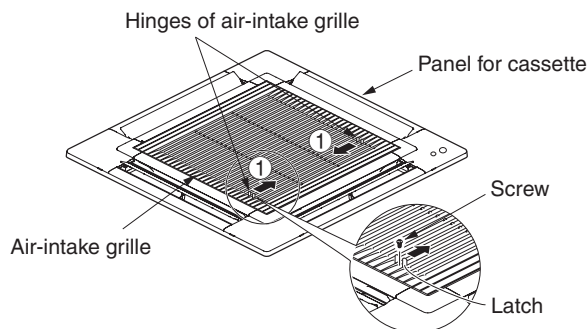
- Never place the panel face-down. Either hang it vertically or place it on top of a projecting object. Placing it face-down will damage the surface.
- Do not touch the flap or apply force to it. (This may cause flap malfunction.)



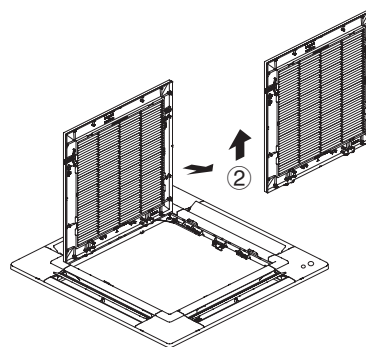
How to Install the Panel for Cassette

(1) Removing the air-intake grille

- 1) Remove the 2 screws on the latch of the air-intake grille. (Reattach the air-intake grille after installation of the panel for cassette.)
- 2) Slide the air-intake grille catches in the direction shown by the arrows ① to open the grille.

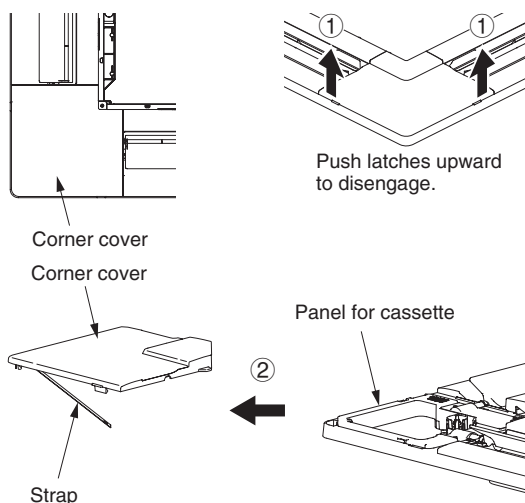


- 3) With the air-intake grille opened, remove the grille hinge from the panel for cassette by sliding it in the direction shown by the arrow ②. (Reattach the air-intake grille after installation of the panel for cassette.)



(2) Removing the corner cover

Push the latches on the corner cover in the direction of the arrow ① and remove them by sliding in the direction of the arrow ②.

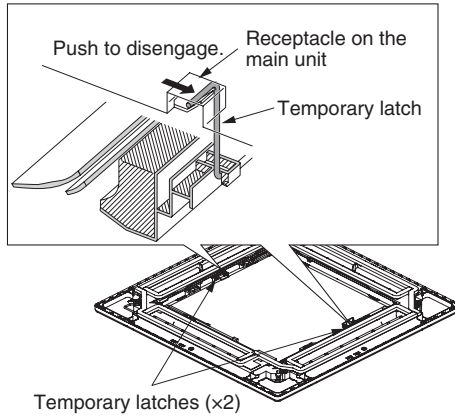


(3) Installing the panel for cassette

The power must be turned ON in order to change the flap angle. (Do not attempt to move the flap by hand. Doing so may damage the flap.)

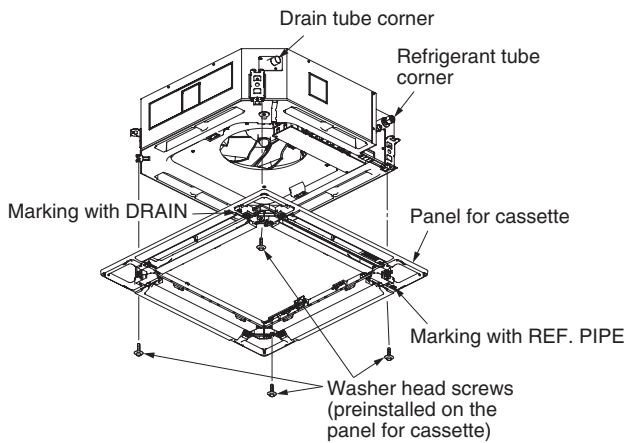
1) Hang the temporary latches on the inside of the panel for cassette to the receptacle on the unit to temporarily attach the panel for cassette in place.

- The panel for cassette must be installed in the correct direction relative to the unit. Align the REF. PIPE and DRAIN marks on the panel for cassette corner with the correct positions on the unit.
- When removing the panel for cassette, push the temporary latches outward while holding the panel for cassette.

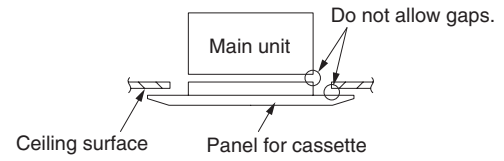


2) Align the panel installation holes and the unit screw holes.

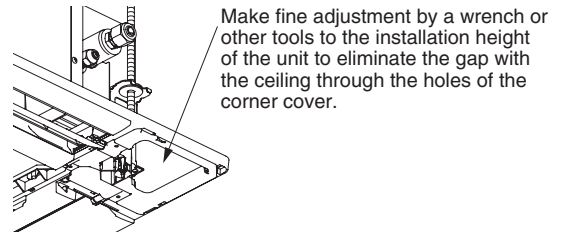
3) Tighten the provided washer head screws at the 4 panel installation locations so that the panel is attached tightly to the unit.



- 4) Check that the panel is attached tightly to the ceiling.
- At this time, make sure that there are no gaps between the unit and the panel for cassette, or between the panel for cassette and the ceiling surface.

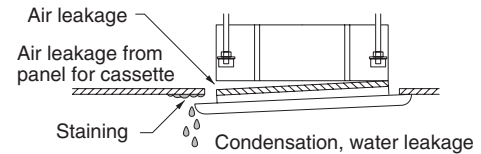


- If there is a gap between the panel and the ceiling, leave the panel for cassette attached and make fine adjustments to the installation height of the unit to eliminate the gap with the ceiling.

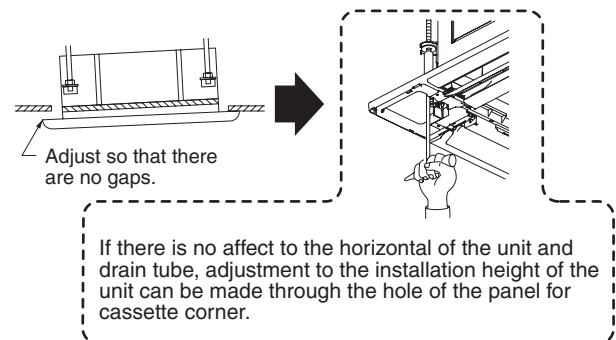


CAUTION

- If the screws are not sufficiently tightened, trouble such as that shown in the figure below may occur. Be sure to tighten the screws securely.

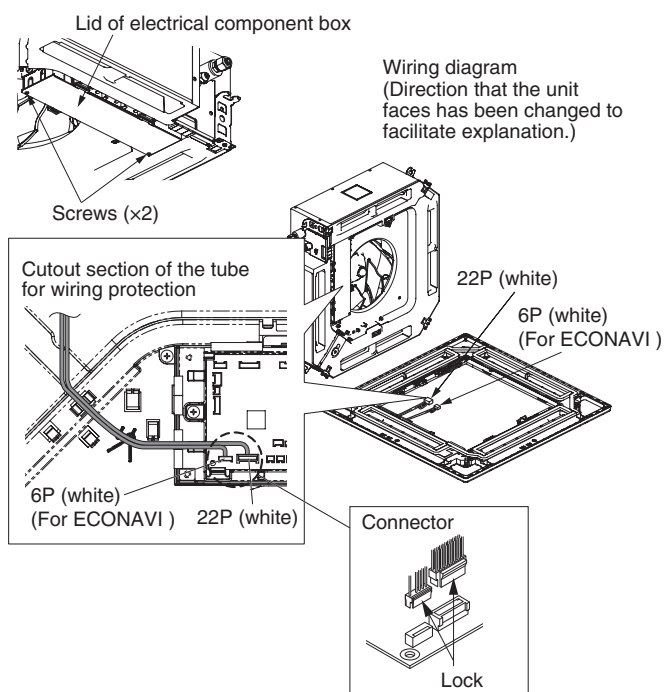


- If a gap remains between the ceiling surface and the panel for cassette even after the screws are tightened, adjust the height of the unit again.



(4) Wiring the Panel for Cassette

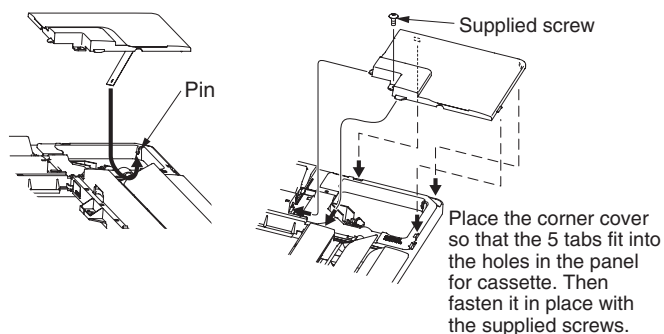
- 1) Open the cover of the electrical component box for control PCB.
 - 2) Connect the 22P connector (white) and 6P connector (white) from the panel for cassette to the connector on the control PCB in the unit electrical component box. In this case, expose the cutout section of the tube for the wiring protection to the outside from the electrical component box and fix it with the clumper attached to the electrical component box.
- **Insert connector lock facing PCB edge until it is locked in place. (If not connected completely, the Auto Flap will not operate and “P09” is displayed on the remote controller. When the connector plugged in the wrong direction, parts on the PCB may be damaged.)**
 - **Check that the wiring connector is not caught between the electrical component box and the cover.**
 - **Check that the wiring connector is not caught between the unit and the panel for cassette.**



(5) How to Attach the Corner & Air-Intake Grille

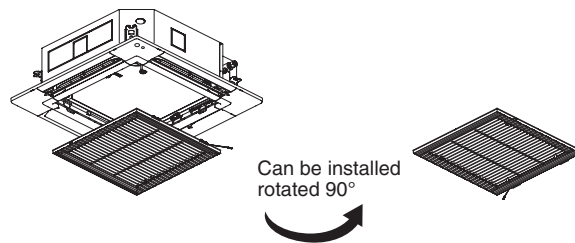
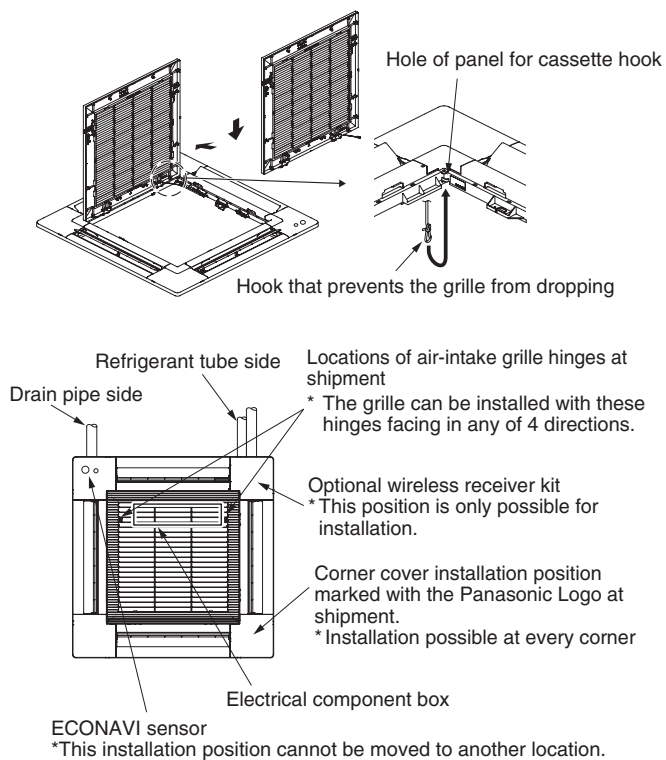
A. Attaching the corner cover

- 1) Check that the safety cord from the corner cover is fastened to the panel for cassette pin, as shown in the figure below.
- 2) Use the supplied screws to attach the corner cover to the panel for cassette.



B. Attaching the air-intake grille

- To install the air-intake grille, follow the steps for “Removing the grille” in the reverse order. By rotating the air-intake grille, it is possible to attach the grille onto the panel for cassette from any of 4 directions. Coordinate the directions of the air-intake grilles when installing multiple units, and change the directions according to customer’s requests.
- When attaching the air-intake grille, be careful that the flap lead wire does not become caught.
- Be sure to attach the safety cord that prevents the air-intake grille from dropping off to the panel for cassette unit as shown in the figure below.
- With this panel for cassette, the directions of the air-intake grille lattices when installing multiple units, and the position of the label showing the company name on the corner panel, can be changed according to customer’s requests, as shown in the figure below. However, the wireless signal receiver can only be installed at the refrigerant-tubing corner of the ceiling unit.



Others

(1) Checking After Installation

- 1) Check that there are no gaps between the unit and the panel for cassette, or between the panel for cassette and the ceiling surface.

* Gaps may cause water leakage and condensation.

- 2) Check that the wiring is securely connected.

* If it is not securely connected, the auto flap will not operate.

("P09" is displayed on the remote controller.)

In addition, the water leakage and condensation may occur.

(2) Operating the Wireless Remote Controller

For details of installation, refer to the section "Wireless Signal Receiver" in the supplied installation instructions.

(3) Selecting DC Fan Motor Tap (4-Way Cassette)

Check the optional parts accordingly in the following table.

Table for DC Fan Motor Tap Settings

Setting No.	Remote controller setting data Item code 5d	Contents & optional parts name
(1)	0001	Air-flow blocking kit (for 3-way air flow)* ²
		Air-flow blocking kit (when a duct is connected.)
		High-ceiling setting 1* ²
(3)	0003	High-ceiling setting 2* ²
(6)	0006	Air-flow blocking kit (for 2-way air flow)* ²

*1 When using optional parts in different setting No. in combination with multiple units, conform it to the larger setting No.

*2 Ceiling height (m)

Indoor unit type	50	60, 71	100,125
Standard (factory setting)	2.7	3.0	3.6
High-ceiling setting 1	3.2	3.3	4.3
High-ceiling setting 2	3.5	3.6	5.0
Air-flow blocking kit (for 3-way air flow)	3.8	3.8	4.7
Air-flow blocking kit (for 2-way air flow)	4.2	4.2	5.0

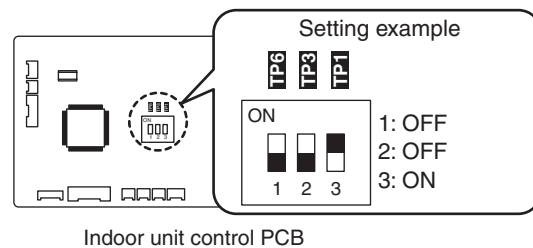
1) When setting on the P.C. Board

<Procedure>

Stop the system before performing these steps.

- ① Open the electrical component box cover, then check the indoor unit control PCB.
- ② Change the DIP switch on the indoor unit control PCB in accordance with the setting number which was confirmed in Table for DC Fan Motor Tap Settings.

Setting No.	DIP switch	Setting No.	DIP switch
(1)		(6)	
(3)			



<Procedure of CZ-RTC5B>

Stop the system before performing these steps.

- ① Keep pressing the , and buttons simultaneously for 4 or more seconds. The "Maintenance func" screen appears on the LCD display.

Maintenance func	20:30 (THU)
1. Outdoor unit error data	
2. Service contact	
3. RC setting mode	
4. Test run	
▼ Sel.	▶ Page [] Confirm

- ② Press the or button to see each menu. If you wish to see the next screen instantly, press the or button. Select "8. Detailed settings" on the LCD display and press the button.

Maintenance func	20:30 (THU)
5. Sensor info.	
6. Servicing check	
7. Simple settings	
8. Detailed settings	
◄ Sel.	▶ Page [] Confirm

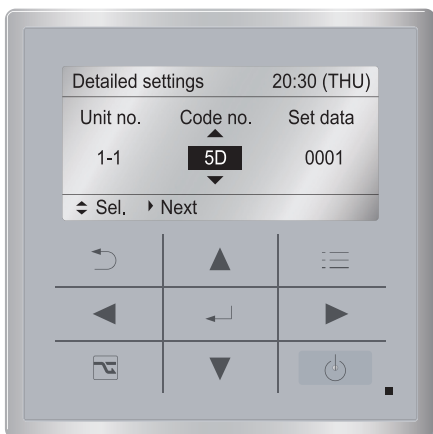
The "Detailed settings" screen appears on the LCD display.

- ③ Select the "Unit no." by pressing the or button for changes.

Detailed settings		20:30 (THU)
Unit no.	Code no.	Set data
1-1	10	0001
Sel.		Next

- ④ Select the "Code no." by pressing the or button.

Change the "Code no." to "5D" by pressing the or button (or keeping it pressed).



- ⑤ Select the "Set data" by pressing the or button.

Select one of the "Set data" in "Table for DC Fan Motor Tap Settings" by pressing the or button.

Then press the button.

Detailed settings		20:30 (THU)
Unit no.	Code no.	Set data
1-1	5D	0003
Sel.		[confirm] Confirm

- ⑥ Press the button. The "Exit detailed settings and restart?" (Detailed setting-end) screen appears on the LCD display. Select "YES" and press the button.

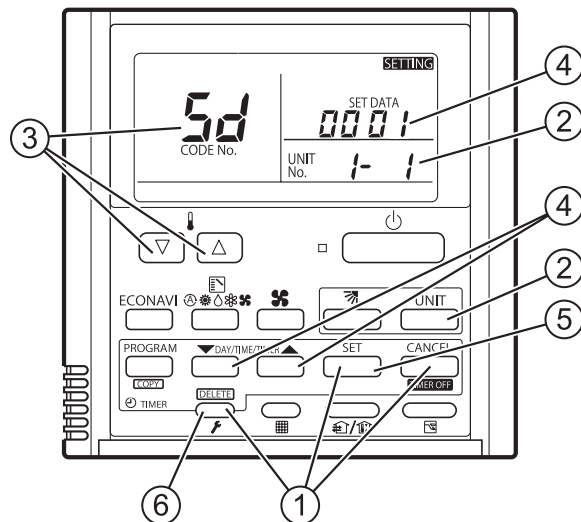
Exit detailed settings and restart?	
YES	NO

If you wish to change the selected indoor unit, follow the step ②.

<Procedure of CZ-RTC4>

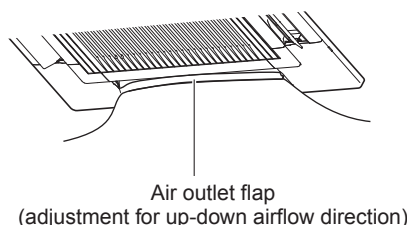
Stop the system before performing these steps.

- ① Press and hold the , and buttons simultaneously for 4 seconds or longer.
- ② If group control is in effect, press the button to set. At this time, the fan at the indoor unit begins and select the address (unit No.) of the indoor unit operating.
- ③ Designate the item code **5d** by adjusting the Temperature Setting / buttons.
- ④ Press the timer time buttons to select the desired setting data.
*For item codes and setting data, see the "Table for DC Fan Motor Tap Settings".
- ⑤ Press the button.
(The display stops blinking and remains lit, and setting is completed.)
If you wish to change the selected indoor unit, follow the step ②.
- ⑥ Press the button to return to normal remote controller display.



(4) Setting the Flap Separately

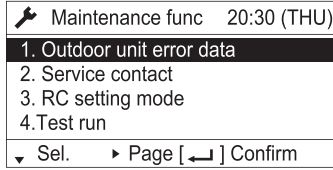
- 1) The 4-air outlet flap can be adjusted separately during operation. When not adjusted separately, all flaps operate in the same manner.



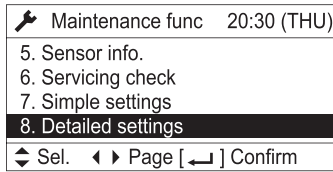
<Procedure of CZ-RTC5B>

Stop the system before performing these steps.

- ① Keep pressing the , and buttons simultaneously for 4 or more seconds. The "Maintenance func" screen appears on the LCD display.

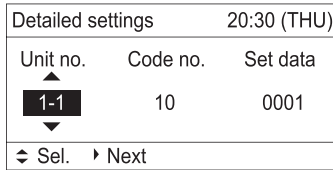


- ② Press the or button to see each menu. If you wish to see the next screen instantly, press the or button. Select "8. Detailed settings" on the LCD display and press the button.

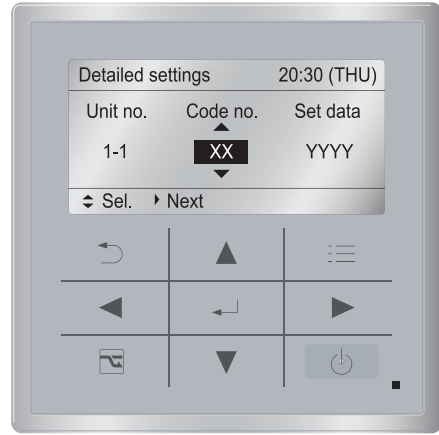
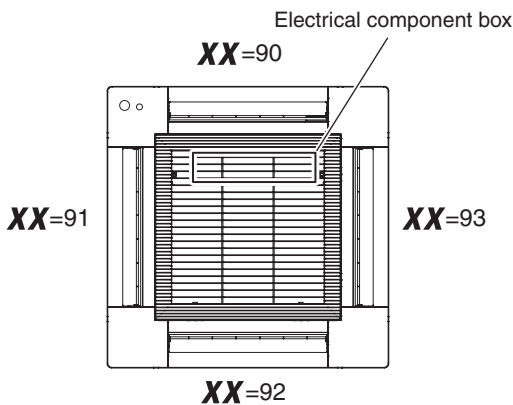


The "Detailed settings" screen appears on the LCD display.

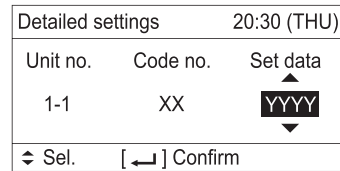
- ③ Select the "Unit no." by pressing the or button for changes.



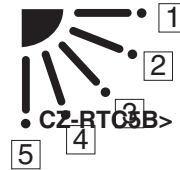
- ④ Select the "Code no." by pressing the or button. Change the "Code no." to "XX" by pressing the or button (or keeping it pressed).



- ⑤ Select the "Set data" by pressing the or button. Select one of the Setting Data "YYYY" by pressing the or button. Then press the button.



Flap position



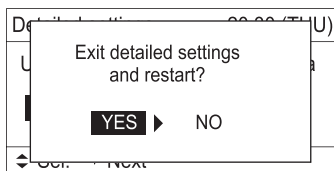
* Setting data "YYYY"

Setting data	Flap position during operation
0000	Without separate setting
0001	Swing
0002	Move to position 1 and stay
0003	Move to position 2 and stay
0004	Move to position 3 and stay
0005	Move to position 4 and stay
0006	Move to position 5 and stay

NOTE

The flap swings during the operation under "Setting the Flap Separately". At this time, the unselected flaps are moved to the position 1.

- ⑥ Press the button. The "Exit detailed settings and restart?" (Detailed setting-end) screen appears on the LCD display. Select "YES" and press the button.



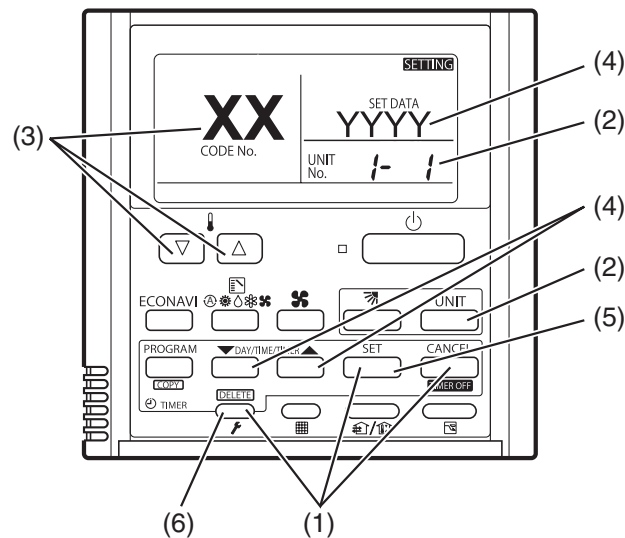
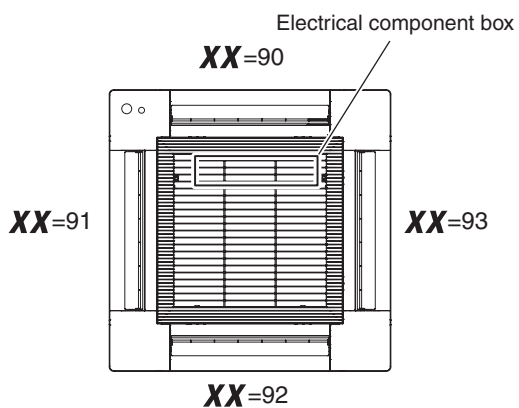
If you wish to change the selected indoor unit, follow the step (2).

- (5) Press the button.
(The display stops blinking and remains lit, and setting is completed.)
If you wish to change the selected indoor unit, follow the step (2).
- (6) Press the button to return to normal remote controller display.

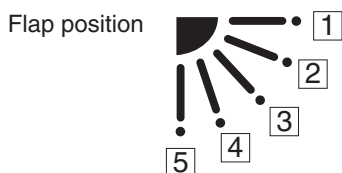
<Procedure of CZ-RTC4>

Stop the system before performing these steps.

- (1) Press and hold the , and buttons simultaneously for 4 seconds or longer.
- (2) If group control is in effect, press the button to set. At this time, the fan at the indoor unit begins and select the address (unit No.) of the indoor unit operating.
- (3) Designate the item code "XX" by adjusting the Temperature Setting buttons.



- (4) Press the timer time buttons to select the desired setting data.



* Setting data "YYYY"

Setting data	Flap position during operation
0000	Without separate setting
0001	Swing
0002	Move to position and stay
0003	Move to position and stay
0004	Move to position and stay
0005	Move to position and stay
0006	Move to position and stay




NOTE

The flap swings during the operation under "Setting the Flap Separately".
At this time, the unselected flaps are moved to the position .

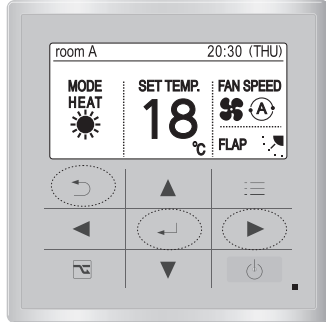
■ ECONAVI SYSTEM SETTING

Change the settings of main and sub indoor units to correspond to the ECONAVI system function.
For the benefit of using the ECONAVI function, the main indoor unit should be provided with the ECONAVI function.




1. Press three buttons.


Keep pressing the ,  and  buttons simultaneously for more than 4 seconds.

The "Maintenance func" menu appears on the screen.



2. Select "0. ECONAVI info." from the menu command.

By pressing the  /  buttons, select "0. ECONAVI info." and press the  button.

 Maintenance func	20:30 (THU)
0. ECONAVI info.	
1. Outdoor unit error data	
2. Service contact	
3. RC. setting mode	
◀ Sel. ▶ Page [↵] Confirm	

3. Select "System settings" from the menu command.

By pressing the  /  buttons, select "System settings" and press the  button.

ECONAVI info.	20:30 (THU)
Sensor unit info.	
System settings	
Status info.	
Error found	
◀ Sel. [↵] Check	

NOTE

- After operating Step 2, the following messages may occasionally appear on the screen.

Display message	Contents
Disabled in default mode.	After a while, select "0. ECONAVI info." again. If no status changes even after 10 minutes, make auto address setting and then select "0. ECONAVI info."

- After operating Step 3, the following messages may occasionally appear on the screen.

Display message	Contents
Setup is not required.	The main indoor unit has already been provided with the ECONAVI function. So, it works right out of the box.
Main indoor unit is not found.	The power of indoor unit may possibly shut down. Check the power supply of indoor unit.
Indoor unit with ECONAVI is not found.	Since all indoor units in the group control are not available for the ECONAVI function, the ECONAVI function cannot be used.

4. Start settings.


By pressing the  /  buttons, select "YES" and press the  button.

ECONAVI sys. set.	20:30 (THU)
Start setup?	
YES ▶ NO	
▶ Sel. [↵] Confirm	

5. When finished settings, the system restarts automatically.

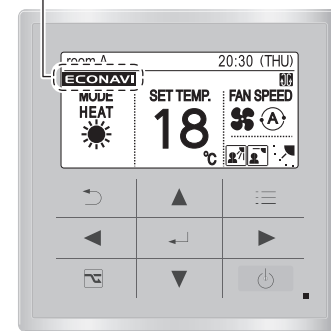
6. Check whether the ECONAVI function is set.

ECONAVI is displayed on the screen.

If the display is not operated, press the  button and set it in operating mode.

If operation is in fan mode, **ECONAVI** is not displayed. Set in any operating mode other than fan mode.

"**ECONAVI**" is displayed when setting the ECONAVI function.






■ ECONAVI TEST OPERATION

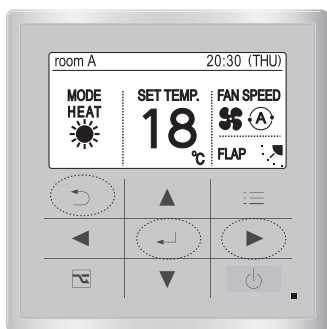
Preparation: Refer to the manuals of the indoor unit and turn on the main power switch in advance.

Human detection cannot be made for approx. 90 seconds when switched on the power because the human detection sensor is set in initial setup.

1. Press three buttons.



Keep pressing the ,  and  buttons simultaneously for more than 4 seconds.

The "Maintenance func" menu appears on the screen.







2. Select "0. ECONAVI info." from the menu command.

By pressing the  /  buttons, select "0. ECONAVI info." and press the  button.

 Maintenance func	20:30 (THU)
0. ECONAVI info.	
1. Outdoor unit error data	
2. Service contact	
3. RC. setting mode	
▼ Sel.	▶ Page [] Confirm

3. Select "Error found" from the menu command.

By pressing the  /  buttons, select "Error found" and press the  button.

ECONAVI info.	20:30 (THU)
Sensor unit info.	
System settings	
Status info.	
Error found	
▲ Sel.	[] Check

4. Check the sensor status shows "Normal".

(By pressing the  /  buttons, the status of each indoor unit can be scrolled on the screen.)

The sensor status of all indoor units are displayed.

- "Normal": The sensor on the panel for cassette (ECONAVI type) works normally.
- "Preparing": The sensor on the panel for cassette (ECONAVI type) is set in initial setup. Confirm that "Normal" appears within 90 seconds.
- "Unsupported": Indoor units not available for ECONAVI function.

Error found	20:30 (THU)
Unit no.	Status
1 - 1	Normal
1 - 2	Normal
Sensor 1	Not connected
▲ Scroll	

The test run procedure described above is over. If any display appears other than "Normal" or "Preparing" even though the ECONAVI panel is connected, follow the Step 5 below.

* "1-1", "1-2" mean indoor unit No. If the indoor unit is without ECONAVI panel, "Not connected" appears.

* "Sensor 1" means optional ECONAVI sensor (CZ-CENSC1). If not connected, "Not connected" appears besides "Sensor 1" on the screen.

5. If the sensor status shows other than "Normal", "Preparing",



If the sensor status shows "Error" or "Not connected" although the panel for cassette (ECONAVI type) is connected, the following symptom may have occurred. Specify the applicable indoor unit and check the sensor. "Error": The sensor may possibly be damaged.

"Not connected": The wiring between the indoor unit and sensor may possibly be disconnected.


* The specified indoor unit can be confirmed by the flap operation.

Confirmation method:

- ① Finish the maintenance function.

Press the  button to show the maintenance function display and then press the  button.

- ② Operate the flap.

By pressing the  button, select the applicable "Indoor Unit No." in the list of "2. FLAP" and then make flap setting. The indoor unit which responds to the flap setting becomes available.

When the indoor unit is specified, turn off the main power switch and disconnect the connector of sensor wiring from the PCB. Then reconnect it. Turn on the main power switch and repeat the Steps 1 to 4 described above. Confirm the display shows "Error found". If the display shows "Error" or "Not connected" on the screen again, it is necessary to replace the panel for cassette (ECONAVI type) with a new one.

EXTERNAL DEVICE INTERLOCK

Example of wiring:

This is an example of the combination systems which extract optional output signal by the service wire and relay (field supply). When actuating the external device interlock, use the thermostat signal.

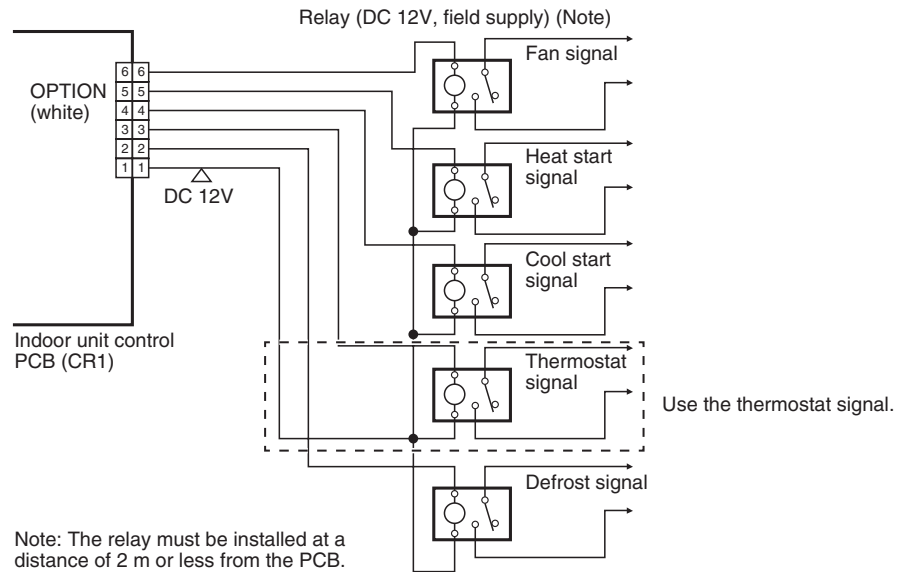
OPTION Connector (CN060) Output external signals



PAW-OCT: Panasonic has developed an optional accessory (consisting of plug + wires) called PAW-OCT to enable an easy connection to this OPTION Connector (CN060).

With the combination of the T10 and the OPTION Connector (CN060) an external control of the I_U is possible!

6P (WHITE): OUTPUTS EXTERNAL SIGNALS AS SHOWN IN THE FIGURE BELOW.



NOTE

- The external output signal from the air conditioner is supplied for the purpose of controlling the external devices. If the air conditioner does not operate, take measures that the movement of external connecting devices can transfer to the safety zone in advance.
- The external output signal from the air conditioner is turned off when the blackout occurs. If any special considerations are needed in case of blackout, provide an external circuit.

■ CHECKLIST AFTER INSTALLATION WORK

Work List	No.	Content	Check <input checked="" type="checkbox"/>	Possibility of Failure & Checkpoint	
Installation	1	Are the indoor units installed following the content on page 1-12-2-2-1 "SELECTING THE INSTALLATION SITE"?	<input type="checkbox"/>	There is a possibility of light injure or loss of property.	
Tubing & Wiring	2	In the case of multiple installation: Is there a wrong tubing connection with another system?	<input type="checkbox"/>	The unit is inoperated or the refrigerant flows into the inoperative unit and the leakage is expected. Check if there is a wrong tubing or wiring connection with another system.	
	3	In the case of multiple installation: Is there a wrong wiring connection with another system?	<input type="checkbox"/>		
	4	Is the earth leakage circuit breaker (all-pole switching function provided) installed?	<input type="checkbox"/>	Power failure or short circuit may cause electric shock or fire. Check installation work and ground wire work.	
	5	Is there any wrong installation of optional parts or wrong wiring?	<input type="checkbox"/>		
	6	Was the ground wire work performed?	<input type="checkbox"/>		
	7	Are there any wrong power supply wiring, wrong connection wire, wrong signal wire or loose screw?	<input type="checkbox"/>		
	8	Is the thickness of wire in accordance with rule?	<input type="checkbox"/>		
	9	Is the power-supply voltage equal to the nameplate of the unit?	<input type="checkbox"/>		
	10	Was the check of the airtight test, flared tube fitting and gas leakage on the welded portion performed?	<input type="checkbox"/>		If the gas leakage occurs, the unit quality not only becomes inferior but affects environment. Repair it as quickly as possible.
	Drain Check	11	Has the adhesive been applied to the drain connecting portion (resin portion) of the indoor unit?		<input type="checkbox"/>
12		Is there water leakage?	<input type="checkbox"/>	Since there is a possibility of water drain, repair the drain pipe if the drain failure or water drain occurs.	
13		Indoor unit drain pipe has a downward gradient (1/100 or more) by rule. Is the drain water flowing smoothly?	<input type="checkbox"/>		
Heat Insulation	14	Was the heat insulation work at a suitable location including the flared tube fitting (refrigerant tube & drain pipe) performed properly?	<input type="checkbox"/>	The quality of unit not only becomes inferior but there is a possibility of the water drain. So, perform the heat insulation work properly.	
Optional Parts	15	Was the short-circuit connector connected or the fan tap changed when installing the air-blocking material?	<input type="checkbox"/>	The discharge temperature decreases in cooling mode according to the reduction of air volume and there is a possibility of dew drops. Be sure to change settings.	
Test Run	16	Did the abnormal sound occur?	<input type="checkbox"/>	Check if there is a fan contact or distortion of the indoor unit.	
	17	Did the cool and warm airflow discharge from the indoor unit?	<input type="checkbox"/>	Check if the unit does not operate or there is a wrong tubing or wiring connection with another system.	

■ APPENDIX

Care and Cleaning



WARNING

- For safety, be sure to turn the air conditioner off and also to disconnect the power before cleaning.
- Do not pour water on the indoor unit to clean it. This will damage the internal components and cause an electric shock hazard.

Air intake and outlet side (Indoor unit)

Clean the air intake and outlet side of the indoor unit with a vacuum cleaner brush, or wipe them with a clean, soft cloth.

If these parts are stained, use a clean cloth moistened with water. When cleaning the air outlet side, be careful not to force the vanes out of place.



CAUTION

- Never use solvents or harsh chemicals when cleaning the indoor unit. Do not wipe plastic parts using very hot water.
- Some metal edges and the fins are sharp and may cause injury if handled improperly; be especially careful when you clean these parts.
- The internal coil and other components of outdoor unit must be cleaned regularly. Consult your dealer or service center.

Air filter

The air filter collects dust and other particles from the air and should be cleaned at regular intervals as indicated in the table below or when the filter indication (■) on the display of the remote controller (wired type) shows that the filter needs cleaning. If the filter gets blocked, the efficiency of the air conditioner drops greatly.

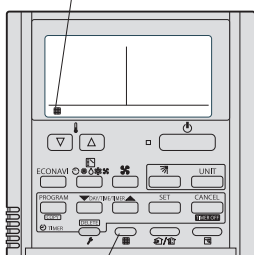
Type	U2
Period	6 months

● After Cleaning

1. After the air filter is cleaned, reinstall it in its original position.
Be sure to reinstall in reverse order.
2. [In the case of Timer Remote Controller]
Press the Filter reset button.
The ■ (Filter) indicator on the display goes out.
[In the case of High-spec Wired Remote Controller]
Refer to the Operating Instructions attached to the optional High-spec Wired Remote Controller.

Timer Remote Controller

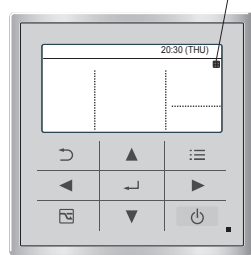
Filter indicator



Filter reset button

High-spec Wired Remote Controller

Filter indicator



NOTE

The frequency with which the filter should be cleaned depends on the environment in which the unit is used. Clean the filter frequently for best performance in the area of dusty or oil spots regardless of filter status.

<How to clean the filter>

1. Remove the air filter from the air-intake grille.
2. Use a vacuum cleaner to remove light dust. If there is sticky dust on the filter, wash the filter in lukewarm, soapy water, rinse it in clean water, and dry it.

<How to remove the filter>

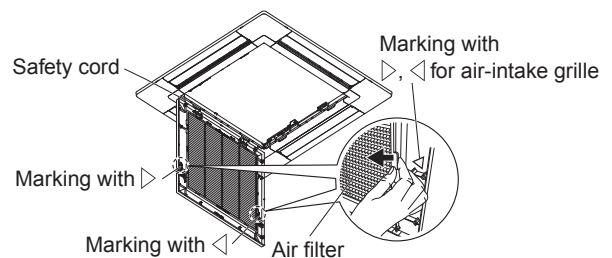
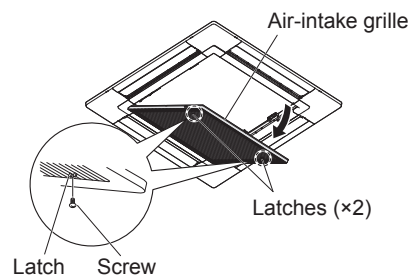
4-Way Cassette Type U2:

1. Use a screwdriver to remove the bolt screw on each side for the two latches. (Be sure to reattach the two bolt screws after cleaning.)
2. Slide the latches of the air-intake grille in the direction of the inside to open the grille.
3. The air-intake grille opens downward.



CAUTION

- When cleaning the air filter, never remove the safety chain. If it is necessary to remove it for servicing and maintenance inside, be sure to reinstall the safety chain securely (hook on the grille side) after the work.
 - When the filter has been removed, rotating parts (such as the fan), electrically charged areas, etc. will be exposed in the unit's opening. Bear in mind the dangers that these parts and areas pose, and proceed with the work carefully.
4. Push the side of the air filter marked with the indication arrow ▽ and pull it toward you. The air filter will be disengaged.



**CAUTION**

- **Certain metal edges and the condenser fins are sharp and may cause injury if handled improperly; special care should be taken when you clean these parts.**
- **Periodically check the outdoor unit to see if the air outlet or air intake is clogged with dirt or soot.**
- **The internal coil and other components must also be cleaned periodically. Consult your dealer or service center.**

Care: After a prolonged idle period

Check the indoor and outdoor unit air intakes and outlets for blockage; if there is a blockage, remove it.

Care: Before a prolonged idle period

- Operate the fan for half a day to dry out the inside.
- Disconnect the power supply and also turn off the circuit breaker.
- Clean the air filter and replace it in its original position.
- Outdoor unit internal components must be checked and cleaned periodically. Contact your local dealer for this service.

■ Troubleshooting

If your air conditioner does not work properly, first check the following points before requesting service. If it still does not work properly, contact your dealer or a service center.


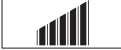
● Indoor unit

Symptom		Cause
Noise	Sound like streaming water during operation or after operation	<ul style="list-style-type: none"> ● Sound of refrigerant liquid flowing inside unit ● Sound of drainage water through drain pipe
	Cracking noise during operation or when operation stops.	Cracking sound due to temperature changes of parts
Odor	Discharged air is smelled during operation.	Indoor odor components, cigarette odor and cosmetic odor accumulated in the air conditioner and its air is discharged. Unit inside is dusty. Consult your dealer.
Dewdrop	Dewdrop gets accumulated near air discharge during operation	Indoor moisture is cooled by cool wind and accumulated by dewdrop.
Fog	Fog occurs during operation in cooling mode. (Places where large amounts of oil mist exist at restaurants.)	<ul style="list-style-type: none"> ● Cleaning is necessary because unit inside (heat exchanger) is dirty. Consult your dealer as technical engineering is required. ● During defrost operation
Fan is rotating for a while even though operation stops.		<ul style="list-style-type: none"> ● Fan rotating makes operation smoothly. ● Fan may sometimes rotates because of drying heat exchanger due to settings.
Wind-direction changes while operating. Wind-direction setting cannot be made. Wind-direction cannot be changed.		<ul style="list-style-type: none"> ● When air discharge temperature is low or during defrost operation, horizontal wind flow is made automatically. ● Flap position is occasionally set up individually.
When wind-direction is changed, flap operates several times and stops at designated position.		When wind-direction is changed, flap operates after searching for standard position.
Dust		Dust accumulation inside indoor unit is discharged.
Poor cooling or heating performance		<p>The indoor unit is initially designed to control the indoor temperature detected by the built-in room sensor inside the indoor unit.</p> <p>Due to indoor unit installation position, however, the built-in sensor may occasionally sense temperature improperly; for example, temperature difference between the ceiling and floor, lighting apparatus, electric fan, windows or waist-high partition walls, etc.</p> <p>In this case, the unit does not operate properly at the desired temperature.</p> <p>You may change the use of the temperature sensor inside the indoor unit to that of the remote controller.</p> <p>Then the desired room temperature can be controlled properly.</p> <p>For details, consult your dealer.</p>

● Check Before Requiring Services

Symptom	Cause	Remedy
Air conditioner does not run at all although power is turned on.	Power failure or after power failure	Press ON/OFF operation button on remote controller again.
	Operation button is turned off.	<ul style="list-style-type: none"> ● Switch on power if breaker is turned off. ● If breaker has been tripped, consult your dealer without turning it on.
	Fuse blow out.	If blown out, consult your dealer.
Poor cooling or heating performance	Air intake or air discharge port of indoor and outdoor units is clogged with dust or obstacles.	Remove dust or obstruction.
	Fan speed switch is set to "Low".*	Change to "Medium" or "High".*
	Improper temperature settings	Refer to "■ Tips for Energy Saving".
	Room is exposed to direct sunlight in cooling mode.	
	Doors and /or windows are open.	
	Air filter is clogged.	Refer to "Care and Cleaning" on page 1-12-2-2-29.
	Too much heat sources in room in cooling mode.	Use minimum heat sources and in a short time.
	Too many people in room in cooling mode.	Reduce temperature settings or change to "Medium" or "High".*

* Fan speed display on the remote controller

High :  (CZ-RTC4),  (CZ-RTC5A, CZ-RTC5B)

Medium :  (CZ-RTC4),  (CZ-RTC5A, CZ-RTC5B)

Low :  (CZ-RTC4),  (CZ-RTC5A, CZ-RTC5B)

If your air conditioner still does not work properly although you checked the points as described above, first stop the operation and turn off the power switch. Then contact your dealer and report the serial number and symptom. Never repair your air conditioner by yourself since it is very dangerous for you to do so.

■ Tips for Energy Saving

Avoid

- Do not block the air intake and outlet of the unit. If either is obstructed, the unit will not work well, and may be damaged.
- Do not let direct sunlight into the room. Use sunshades, blinds or curtains. If the walls and ceiling of the room are warmed by the sun, it will take longer to cool the room.

Do

- Always try to keep the air filter clean. (Refer to "Care and Cleaning" on page 1-12-2-2-29.) A clogged filter will impair the performance of the unit.
- To prevent conditioned air from escaping, keep windows, doors and any other openings closed.

NOTE

Should the power fail while the unit is running

If the power supply for this unit is temporarily cut off, the unit will automatically resume operation once power is restored using the same settings before the power was interrupted.

IMPORTANT INFORMATION REGARDING THE REFRIGERANT USED

NOTE

See "■ Outdoor Unit" under the Section 1-12. Installation Instructions.

■ SERVICING



CAUTION

- Any qualified person who is involved with working on or breaking into a refrigerant circuit should hold a current valid certificate from an industry-accredited assessment authority, which authorizes their competence to handle refrigerants safely in accordance with an industry recognised assessment specification.
- Servicing shall only be performed as recommended by the equipment manufacturer. Maintenance and repair requiring the assistance of other skilled personnel shall be carried out under the supervision of the person competent in the use of flammable refrigerants.
- Servicing shall be performed only as recommended by the manufacturer.
- Prior to beginning work on systems containing flammable refrigerants, safety checks are necessary to ensure that the risk of ignition is minimised. For repair to the refrigerating system, (2) to (6) shall be completed prior to conducting work on the system.
- (1) Work shall be undertaken under a controlled procedure so as to minimise the risk of a flammable gas or vapour being present while the work is being performed.
- (2) All maintenance staff and others working in the local area shall be instructed on the nature of work being carried out. Work in confined spaces shall be avoided. The area around the workspace shall be sectioned off. Ensure that the conditions within the area have been made safe by control of flammable material.
- (3) The area shall be checked with an appropriate refrigerant detector prior to and during work, to ensure the technician is aware of potentially toxic or flammable atmospheres. Ensure that the leak detection equipment being used is suitable for use with all applicable refrigerants, i.e. non-sparking, adequately sealed or intrinsically safe.
- (4) If any hot work is to be conducted on the refrigeration equipment or any associated parts, appropriate fire extinguishing equipment shall be available to hand. Have a dry powder or CO₂ fire extinguisher adjacent to the charging area.
- (5) No person carrying out work in relation to a refrigeration system which involves exposing any pipe work shall use any sources of ignition in such a manner that it may lead to the risk of fire or explosion. All possible ignition sources, including cigarette smoking, should be kept sufficiently far away from the site of installation, repairing, removing and disposal, during which refrigerant can possibly be released to the surrounding space. Prior to work taking place, the area around the equipment is to be surveyed to make sure that there are no flammable hazards or ignition risks. "No Smoking" signs shall be displayed.
- (6) Ensure that the area is in the open or that it is adequately ventilated before breaking into the system or conducting any hot work. A degree of ventilation shall continue during the period that the work is carried out. The ventilation should safely disperse any released refrigerant and preferably expel it externally into the atmosphere.
- (7) Where electrical components are being changed, they shall be fit for the purpose and to the correct specification. At all times the manufacturer's maintenance and service guidelines shall be followed. If in doubt, consult the manufacturer's technical department for assistance.
 - The charge size is in accordance with the room size within which the refrigerant containing parts are installed.
 - The ventilation machinery and outlets are operating adequately and are not obstructed.
 - Marking to the equipment continues to be visible and legible. Markings and signs that are illegible shall be corrected.
 - Refrigeration pipe or components are installed in a position where they are unlikely to be exposed to any substance which may corrode refrigerant containing components, unless the components are constructed of materials which are inherently resistant to being corroded or are suitably protected against being so corroded.
- (8) Repair and maintenance to electrical components shall include initial safety checks and component inspection procedures. If a fault exists that could compromise safety, then no electrical supply shall be connected to the circuit until it is satisfactorily dealt with. If the fault cannot be corrected immediately but it is necessary to continue operation, an adequate temporary solution shall be used. This shall be reported to the owner of the equipment so all parties are advised.

Initial safety checks shall include:

 - That capacitors are discharged. This shall be done in a safe manner to avoid possibility of sparking.
 - That no live electrical components and wiring are exposed while charging, recovering or purging the system.
 - That there is continuity of earth bonding.
- During repairs to sealed components, all electrical supplies shall be disconnected from the equipment being worked upon prior to any removal of sealed covers, etc.
- Particular attention shall be paid to the following to ensure that by working on electrical components, the casing is not altered in such a way that the level of protection is affected. This shall include damage to cables, excessive number of connections, terminals not made to original specification, damage to seals, incorrect fitting of glands, etc.
- Ensure that apparatus is mounted securely.
- Ensure that seals or sealing materials have not degraded such that they no longer serve the purpose of preventing the ingress of flammable atmospheres.
- Replacement parts shall be in accordance with the manufacturer's specifications.

NOTE:

The use of silicon sealant may inhibit the effectiveness of some types of leak detection equipment. Intrinsically safe components do not have to be isolated prior to working on them.

- Do not apply any permanent inductive or capacitance loads to the circuit without ensuring that this will not exceed the permissible voltage and current permitted for the equipment in use.
- Intrinsically safe components are the only types that can be worked on while live in the presence of a flammable atmosphere.
- The test apparatus shall be at the correct rating.
- Replace components only with parts specified by the manufacturer. Unspecified parts by manufacturer may result ignition of refrigerant in the atmosphere from a leak.

■ REMOVAL AND EVACUATION



CAUTION

- When breaking into the refrigerant circuit to make repairs – or for any other purpose – conventional procedures shall be used. However, it is important that best practice is followed since flammability is a consideration. The following procedure shall be adhered to:
 - Remove refrigerant.
 - Purge the circuit with inert gas.
 - Evacuate.
 - Purge again with inert gas.
 - Open the circuit by cutting or brazing.
- The refrigerant charge shall be recovered into the correct recovery cylinders.
- The system shall be “flushed” with Oxygen free nitrogen (OFN) to render the unit safe.
- This process may need to be repeated several times.
- Compressed air or oxygen shall not be used for this task.
- Flushing shall be achieved by breaking the vacuum in the system with Oxygen free nitrogen (OFN) and continuing to fill until the working pressure is achieved, then venting to atmosphere, and finally pulling down to a vacuum.
- This process shall be repeated until no refrigerant is within the system.
- When the final Oxygen free nitrogen (OFN) charge is used, the system shall be vented down to atmospheric pressure to enable work to take place.
- This operation is absolutely vital if brazing operations on the pipe work are to take place.
- Ensure that the outlet for the vacuum pump is not close to any ignition sources and there is ventilation available.

■ CHARGING PROCEDURES

NOTE

See “■ Outdoor Unit” under the Section 1-12. Installation Instructions.

■ DECOMMISSIONING



CAUTION

- Before carrying out this procedure, it is essential that the technician is completely familiar with the equipment and all its details.
- It is recommended good practice that all refrigerants are recovered safely.
- Prior to the task being carried out, an oil and refrigerant sample shall be taken in case analysis is required prior to re-use of reclaimed refrigerant.
- It is essential that electrical power is available before the task is commenced.
 - a) Become familiar with the equipment and its operation.
 - b) Isolate system electrically.
 - c) Before attempting the procedure ensure that:
 - Mechanical handling equipment is available, if required, for handling refrigerant cylinders.
 - All personal protective equipment is available and being used correctly.
 - The recovery process is supervised at all times by a competent person.
 - Recovery equipment and cylinders conform to the appropriate standards.
 - d) Pump down refrigerant system, if possible.
 - e) If a vacuum is not possible, make a manifold so that refrigerant can be removed from various parts of the system.
 - f) Make sure that cylinder is situated on the scales before recovery takes place.
 - g) Start the recovery machine and operate in accordance with manufacturer’s instructions.
 - h) Do not overfill cylinders. (No more than 80 % volume liquid charge).
 - i) Do not exceed the maximum working pressure of the cylinder, even temporarily.
 - j) When the cylinders have been filled correctly and the process completed, make sure that the cylinders and the equipment are removed from site promptly and all isolation valves on the equipment are closed off.
 - k) Recovered refrigerant shall not be charged into another refrigeration system unless it has been cleaned and checked.
- Electrostatic charge may accumulate and create a hazardous condition when charging or discharging the refrigerant. To avoid fire or explosion, dissipate static electricity during transfer by grounding and bonding containers and equipment before charging / discharging.

■ RECOVERY

NOTE

See “12. Recovery” on page 1-12-1-1-6.

Optional Parts

■ Air Intake Chamber

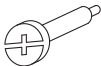


CZ-FDU3

Installation Instructions

Accessory parts

The accessory parts are required for the installation work so they should not be discarded until the work is completed.

- The following parts are provided inside the package so check that they are accounted for.

Part name	No. of parts	Part name	No. of parts	Part name	No. of parts
Screws (5 x 40)  (Used to secure this Air intake chamber)	4	Washers  (Used to secure this Air intake chamber)	4	Installation instructions 	1

Mounting procedure

Before proceeding with the mounting, remove the cushions which have been inserted into the air outlets (in 4 places).

<1> Mounting Air intake chamber (Fig. 1-12-2-2-1)

- Place the black sealant side of Air intake chamber toward the indoor unit.
(Air intake chamber can be mounted correctly in only one way so ensure that the shapes of the indoor unit and chamber are aligned properly.)
- Use the accessory screws (x4) to secure the indoor unit and Air intake chamber.

<2> Installing the indoor unit

- Install the indoor unit with Air intake chamber mounted on it to the ceiling.
(Now proceed with the installation in accordance with the installation instructions provided with the indoor unit.)

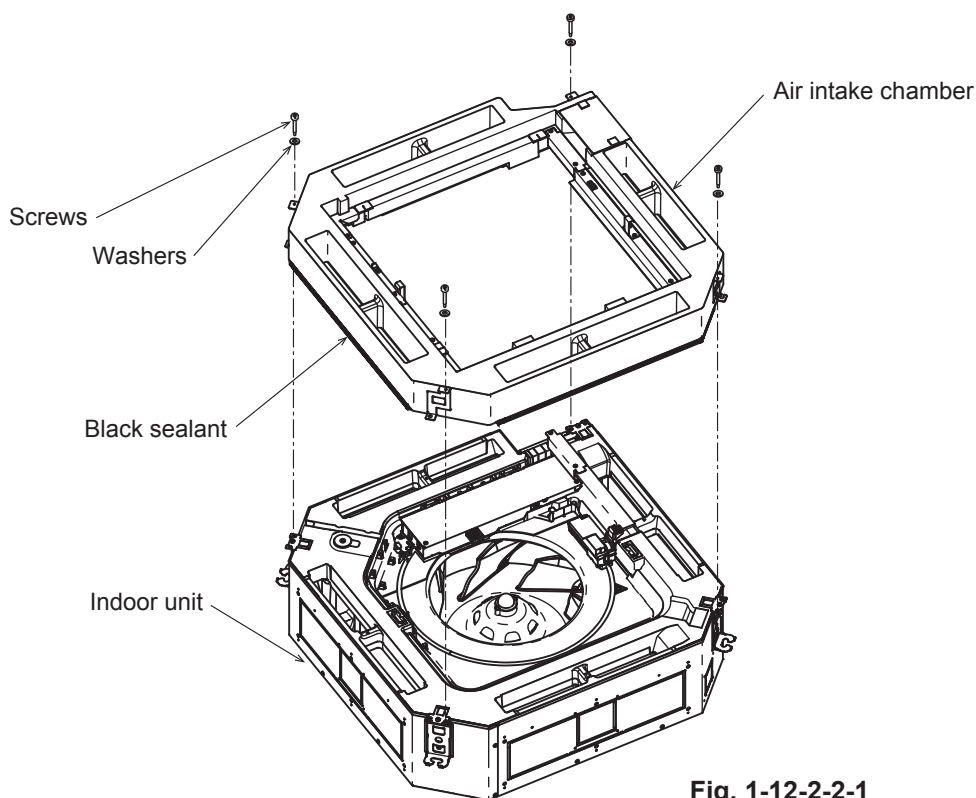


Fig. 1-12-2-2-1

<3> Mounting the ceiling panel (Fig. 1-12-2-2-2)

- Mount the ceiling panel to the indoor unit (with Air intake chamber).
(For details on how the ceiling panel is to be mounted, refer to the installation instructions which are provided with the ceiling panel.)

<4> Connecting the panel cables (Fig. 1-12-2-2-2)

- Remove the cover of Air intake chamber, and remove the cover of electrical component box.
- Cut the clamp used to bundle the ceiling panel cable, insert the 22P connector (white) of the cable into the through-hole in Air intake chamber, and connect it to the 22P connector inside the electrical component box.
- Return the cover of electrical component box and the cover of Air intake chamber to their original positions.

Mounting procedure (continued)

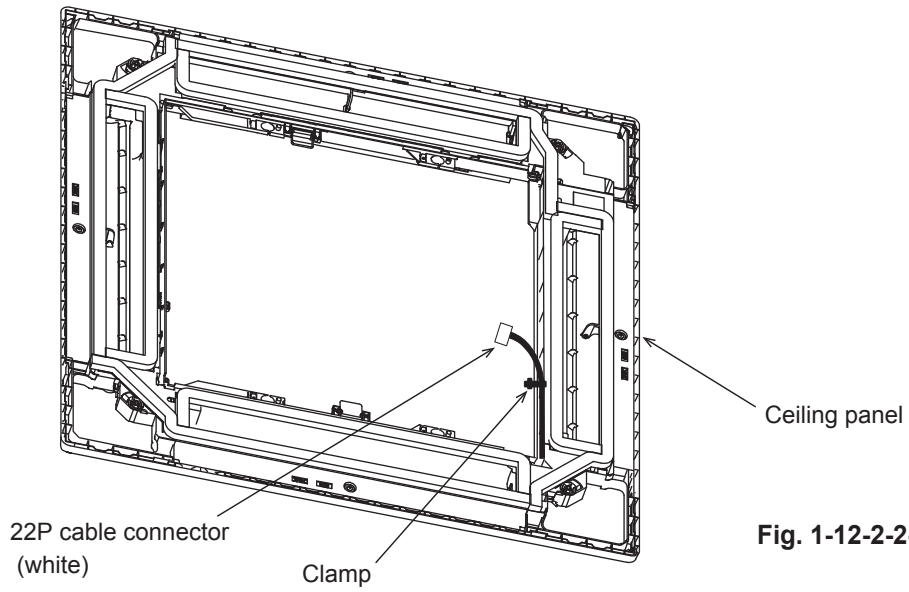
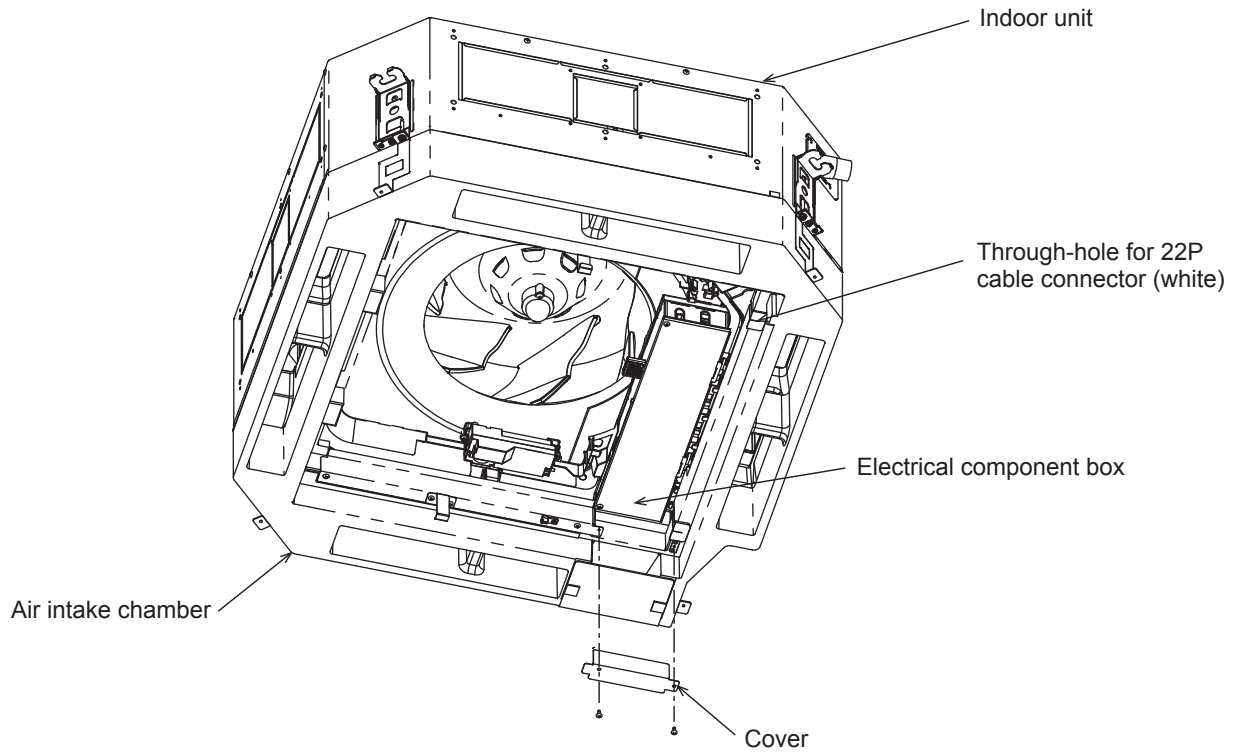


Fig. 1-12-2-2-2

Selecting the DC fan motor taps

It is necessary to set the fan speed in accordance with the intended application and the optional parts to be used if any such part is used. (Table 1-12-2-2-1)

If this speed is not changed, a reduction in the air flow may result, causing the air outlet temperature to drop and condensation to form during cooling.

There are two ways to set the fan speed: either (1) change the positions of the DIP switches on the indoor unit control PCB or (2) set the speed using the wired remote controller. Select one of these ways.

* Priority is given to setting the fan speed by changing the positions of the DIP switches.

Table 1-12-2-2-1 DC fan motor tap setting table

Setting No	Item code 5D/5d setting data	Intended application / name of optional parts	Setting No	Item code 5D/5d setting data	Intended application / name of optional parts
	0000	Standard (factory setting)	(1)	0001	Air-flow blocking kit(for 3-way air flow)
(1)	0001	High-ceiling setting 1 (with standard, ECONAVI panel)	(3)	0003	High-ceiling setting 2 (with standard, ECONAVI panel)
		Air-flow blocking kit (when a duct is connected.)	(6)	0006	Air-flow blocking kit (for 2-way air flow)

(1) When setting the fan speed by changing the positions of the DIP switches on the indoor unit control PCB

<Procedure> Be absolutely sure to turn off the power (earth-leakage circuit breaker).

<1> On Table 1-12-2-2-1, check out the "Setting No." that corresponds to the intended application and the optional parts to be used.

<2> Open the cover of the electrical component box, and check the indoor unit control PCB. (Fig.1-12-2-2-3)

<3> Select the Setting No. which was checked out on Table 1-12-2-2-1, and change the positions of the DIP switches on the indoor unit control PCB.

Setting No.	DIP switch
(1)	<p>DIP switch "ON" position</p> <p>"OFF" position</p>
(3)	<p>DIP switch "ON" position</p> <p>"OFF" position</p>
(6)	<p>DIP switch "ON" position</p> <p>"OFF" position</p>

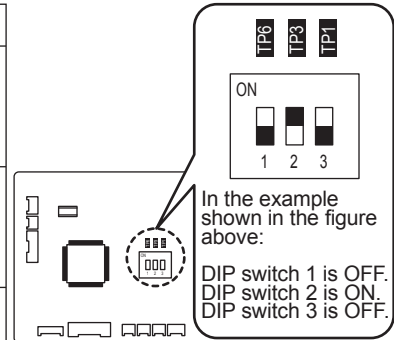


Fig. 1-12-2-2-3
Indoor unit control PCB

(2) When setting the fan speed using a wired remote controller (optional parts: CZ-RTC5B)

On Table 1-12-2-2-1, check out the "Item code 5D setting data" that corresponds to the intended application and the optional parts to be used.

<Procedure> Ensure that the unit has stopped operating before changing the fan speed.

<1> Hold down the + + buttons together for at least 4 seconds. The maintenance function screen is displayed.

<2> Use the / buttons to select the display and the / buttons to select the page.

Select "8. Detailed settings" and press the button. The [Detailed settings screen] appears.

Using the / buttons, select the unit No.

<3> Using the / buttons, select the item code.

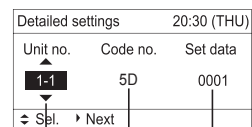
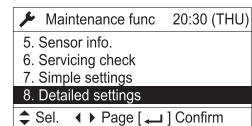
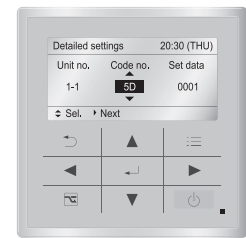
Using the / buttons, change the item code to "5D."

<4> Using the / buttons, select the setting data.

Using the / buttons, change the setting data to the value checked out on Table 1-12-2-2-1, and press the button.

<5> After selecting the unit No. using the / buttons, press the button. The [Detailed settings completion screen] appears.

Select "Yes", and press the button.



Unit No. Setting data
Item code

(3) When setting the fan speed using a wired remote controller (optional parts: CZ-RTC4)

On Table 1-12-2-2-1, check out the "Item code 5d setting data" that corresponds to the intended application and the optional parts to be used.

<Procedure> Ensure that the units have stopped operating before changing the fan speed.

<1> Hold down the + + buttons together for at least 4 seconds.

<2> Each time the button is pressed, the numbers of the indoor units under group control are displayed in sequence.

The fan motor of only the indoor unit that has been selected will run.

<3> Specify item code "5d" using the temperature setting / buttons.

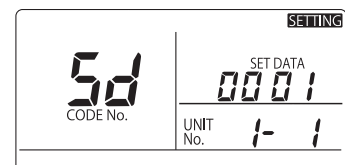
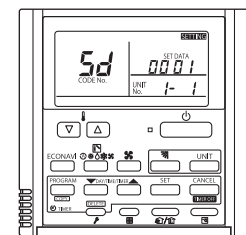
<4> Change the setting data using the hour buttons. The setting data details are as given on Table 1-12-2-2-1.

<5> Press the button. (OK if the display changes from flashing to lighted.)

<6> Press the button. The normal stop status is established.

Go to step <2> to change the selected indoor unit.

<7> Press the button. The normal stop status is established.



**■ Air-flow Blocking Kit
CZ-CFU3**

Installation Instructions

Accessory parts

The accessory parts are required for the installation work so they should not be discarded until the work is completed.

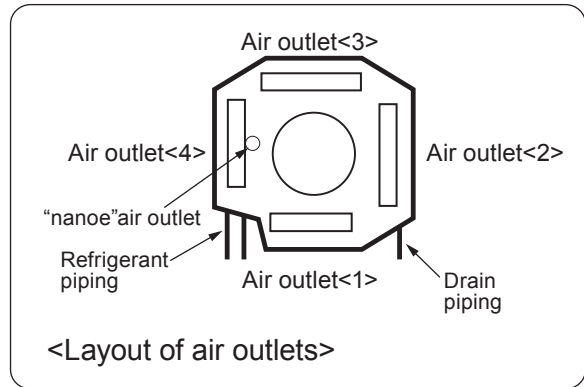
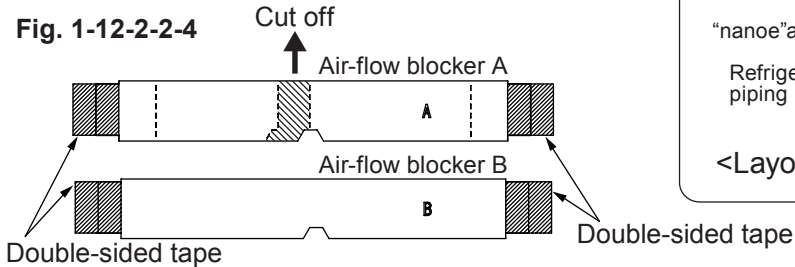
Part name	No. of parts	Part name	No. of parts	Part name	No. of parts
Air-flow blocker (470×65×T10) A:2 B:1	3	Sealer (570×90×T2)	2	Installation instructions	1

Mounting procedure

(1) Checking where the air-flow blocker is to be attached

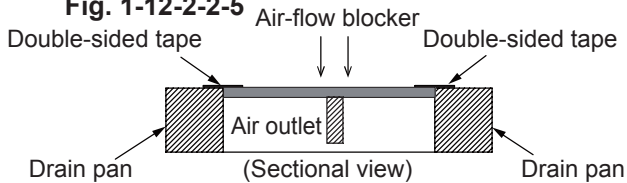
For Air outlet<1>
When Air-flow blocker A is to be attached, cut it in parallel with the slit. (Fig. 1-12-2-2-4)
For Air outlet<2>
Air-flow blocker B can be used as is.
For Air outlet<3>or<4>
Air-flow blocker A can be used as is.

Fig. 1-12-2-2-4



(2) Fit the air-flow blocker into place to match the shape of the air outlet, adhere the tape of the both side of air-flow blocker to the drain pan and adhere the sealer on top to block the passage of air. (Fig. 1-12-2-2-5) (Fig. 1-12-2-2-6)

Fig. 1-12-2-2-5



(3) Adhere the sealer to the drain pan with an overlap of 10 mm or more. (Condensation may form if it is adhered with no overlap.) (Fig. 1-12-2-2-7)

- *1 Ensure that the sealer does not come into contact with the corner metal fitting.
 - *2 Cut the sealer diagonally so that no contact is made with the wire.
- Fold the protruding parts of the sealer over the side panel, and adhere them into place.

Fig. 1-12-2-2-6

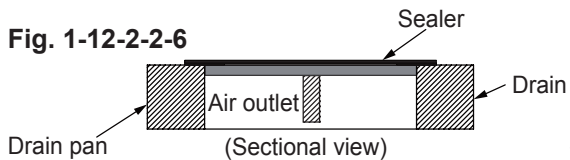
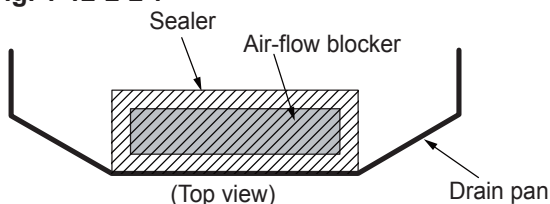
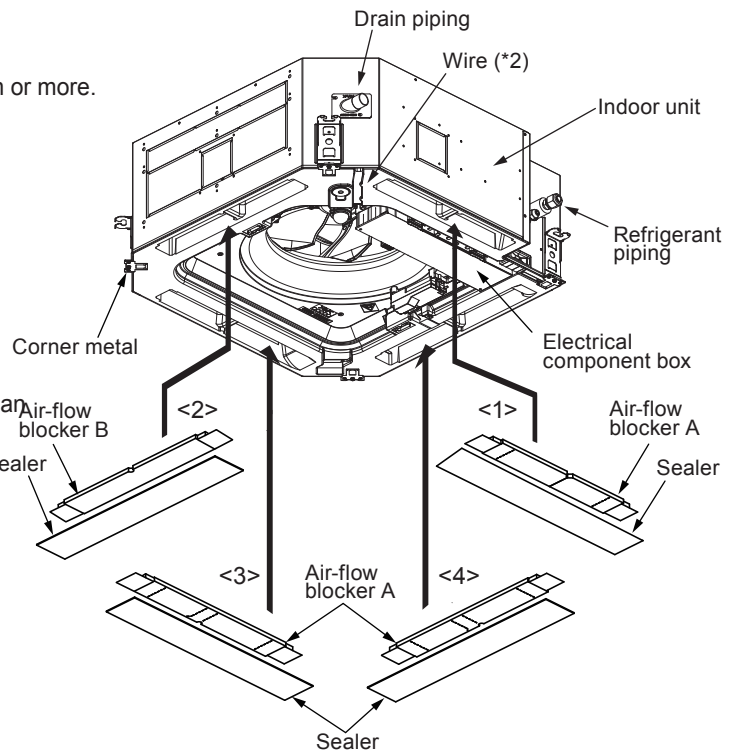


Fig. 1-12-2-2-7



Please affix in accordance with the end of the drain pan.



Air outlet blocking patterns

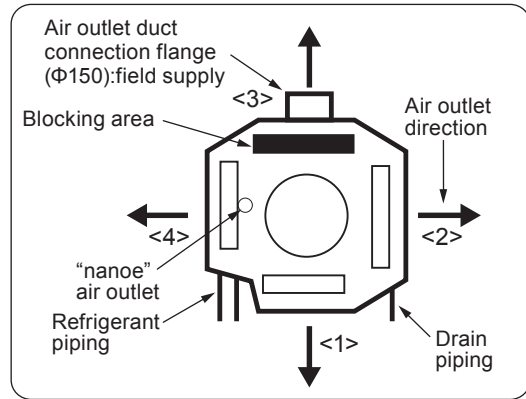
As seen from underneath the indoor unit

- When a 2- or 3-way air outlet configuration is used or when the air outlet duct connection flange (Φ150):field supply is connected, block the air outlets as per the air outlet blocking patterns illustrated below.

Also, refer to the table below, and decide on where the pipings are to be positioned.
(To better understand what the illustrations show, refer to the figure on the right.)

Note: Take care to prevent cold air leaks and deficient insulation while performing the air outlet duct connection flange (Φ150):field supply work in order to prevent condensation from forming.

- It should be borne in mind that any air outlet blocking pattern with the hatching mark will make it impossible for the "nanoe" nano-technology fine particle function to work.
- Under no circumstances must any air outlet blocking patterns not shown in the table below be used.



3-way air outlet One outlet can be blocked.				
2-way air outlet Two outlets can be blocked.				
Air outlet duct connection flange (Φ150):field supply connection 3-way air outlet One outlet can be blocked and connected to a duct.				
Air outlet duct connection flange (Φ150):field supply connection 2-way air outlet Two outlets can be blocked and connected to a duct. Note: The duct can be connected only in one of the locations shown.				

Changing the DC fan tap settings

While referring to "Selecting the DC fan motor taps," change the DC fan speed by using the wired remote controller or by setting the DIP switches on the indoor unit control PCB.

Selecting the DC fan motor taps

It is necessary to set the fan speed in accordance with the intended application and the optional parts to be used if any such part is used. (Table 1-12-2-2)

If this speed is not changed, a reduction in the air flow may result, causing the air outlet temperature to drop and condensation to form during cooling.

There are two ways to set the fan speed: either (1) change the positions of the DIP switches on the indoor unit control PCB or (2) set the speed using the wired remote controller. Select one of these ways.

* Priority is given to setting the fan speed by changing the positions of the DIP switches.

Table 1-12-2-2 DC fan motor tap setting table

Setting No	Item code 5D/5d setting data	Intended application / name of optional parts	Setting No	Item code 5D/5d setting data	Intended application / name of optional parts
	0000	Standard (factory setting)	(1)	0001	Air-flow blocking kit(for 3-way air flow)
(1)	0001	High-ceiling setting 1 (with standard, ECONAVI panel)	(3)	0003	High-ceiling setting 2 (with standard, ECONAVI panel)
		Air-flow blocking kit (when a duct is connected.)	(6)	0006	Air-flow blocking kit (for 2-way air flow)

(1) When setting the fan speed by changing the positions of the DIP switches on the indoor unit control PCB

<Procedure> Be absolutely sure to turn off the power (earth-leakage circuit breaker).

- <1> On Table 1-12-2-2, check out the "Setting No." that corresponds to the intended application and the optional parts to be used.
- <2> Open the cover of the electrical parts box, and check the indoor unit control PCB. (Fig. 1-12-2-2-8)
- <3> Select the Setting No. which was checked out on Table 1-12-2-2, and change the positions of the DIP switches on the indoor unit control PCB.

Setting No.	DIP switch
(1)	<p>DIP switch "ON" position</p> <p>"OFF" position</p>
(3)	<p>DIP switch "ON" position</p> <p>"OFF" position</p>
(6)	<p>DIP switch "ON" position</p> <p>"OFF" position</p>

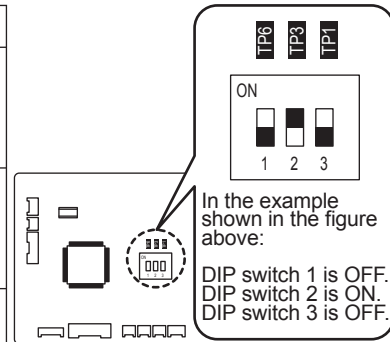


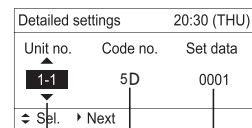
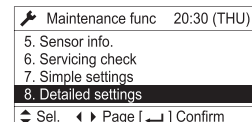
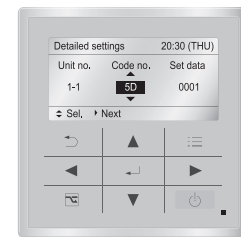
Fig. 1-12-2-8 Indoor unit control PCB

(2) When setting the fan speed using a wired remote controller (optional parts: CZ-RTC5B)

On Table 1-12-2-2, check out the "Item code 5D setting data" that corresponds to the intended application and the optional parts to be used.

<Procedure> Ensure that the unit has stopped operating before changing the fan speed.

- <1> Hold down the + + buttons together for at least 4 seconds. The maintenance function screen is displayed.
- <2> Use the / buttons to select the display and the / buttons to select the page. Select "8. Detailed settings" and press the button. The [Detailed settings screen] appears. Using the / buttons, select the unit No.
- <3> Using the / buttons, select the item code. Using the / buttons, change the item code to "5D."
- <4> Using the / buttons, select the setting data. Using the / buttons, change the setting data to the value checked out on Table 1-12-2-2, and press the button.
- <5> After selecting the unit No. using the / buttons, press the button. The [Detailed settings completion screen] appears. Select "Yes", and press the button.



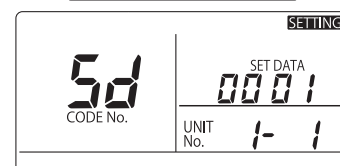
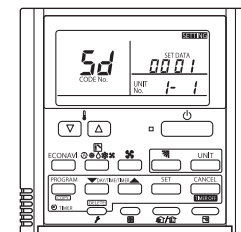
Unit No. Setting data
Item code

(3) When setting the fan speed using a wired remote controller (optional parts: CZ-RTC4)

On Table 1-12-2-2, check out the "Item code 5d setting data" that corresponds to the intended application and the optional parts to be used.

<Procedure> Ensure that the units have stopped operating before changing the fan speed.

- <1> Hold down the + + buttons together for at least 4 seconds.
- <2> Each time the button is pressed, the numbers of the indoor units under group control are displayed in sequence. The fan motor of only the indoor unit that has been selected will run.
- <3> Specify item code "5d" using the temperature setting / buttons.
- <4> Change the setting data using the hour buttons. The setting data details are as given on Table 1-12-2-2.
- <5> Press the button. (OK if the display changes from flashing to lighted.)
- <6> Press the button. The normal stop status is established. Go to step <2> to change the selected indoor unit.
- <7> Press the button. The normal stop status is established.



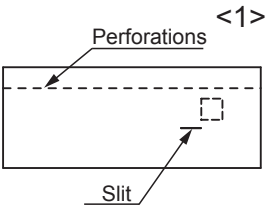
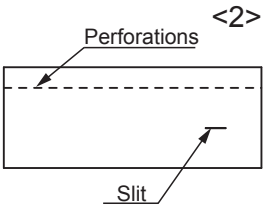
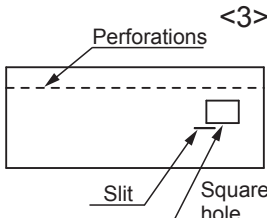
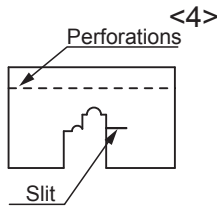
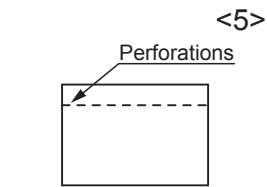
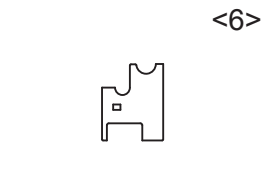
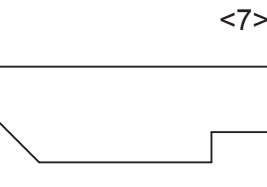
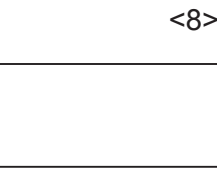
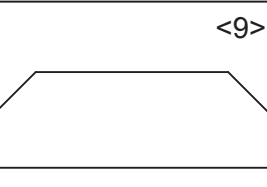
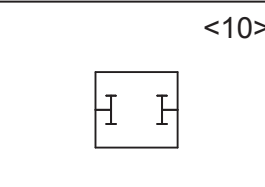
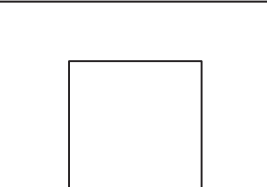
■ Thermal Insulation Kit

CZ-INSU3

Installation Instructions

Parts installed on the indoor unit

● Details of parts

Part name	Side panel insulator	Side panel insulator	Side panel insulator	Side panel insulator
Shape				
No. of parts	1	1	1	1
Part name	Side panel insulator	Side panel insulator	Ceiling insulator	Ceiling insulator
Shape				
No. of parts	1	1	1	1
Part name	Ceiling insulator	Hanger insulator	Installation instructions	
Shape				
No. of parts	1	4	1	

● Procedure for attaching the parts

* Indoor unit has two kinds of heights. (Large unit=319mm, Small unit=256mm)
 When attaching the side panel insulator to the small unit, attach it after cutting along its perforations of the parts<1> to <5>

1. Align the slits of the side panel insulators <1> to <4> with the hanger, and attach the parts to the side panels of the indoor unit. (Fig. 1-12-2-2-9)
2. Now attach the side panel insulator <5> to the side panel of the indoor unit. (Fig. 1-12-2-2-9)
3. Align the side panel insulator <6> with the piping cover, and attach the part. (Fig. 1-12-2-2-9)
4. Attach the ceiling insulators <7> to <9> in such a way that no gaps are left. (Fig. 1-12-2-2-10)

Do the following procedures after installing the indoor unit.

5. Attach the hanger insulators <10> to the hangers in the directions shown in the figure. (Fig. 1-12-2-2-11)
 * Keep hanger insulator<10> until installing the indoor unit.

Parts installed on the indoor unit (continued)

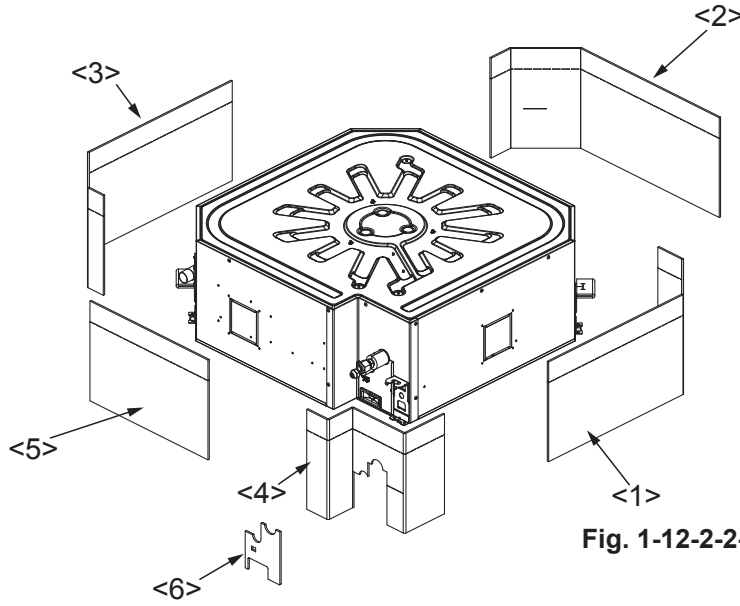


Fig. 1-12-2-2-9

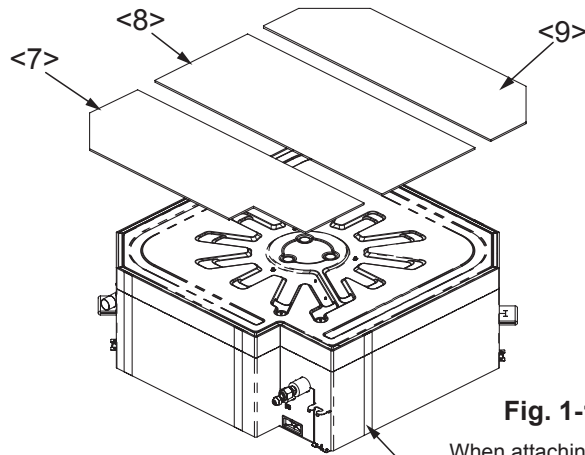


Fig. 1-12-2-2-10

When attaching the insulators, ensure that they overlap. (Side insulators <1> to <5>)

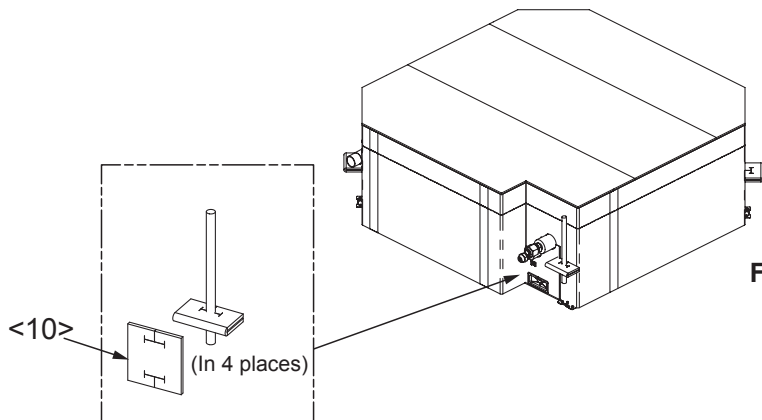


Fig. 1-12-2-2-11

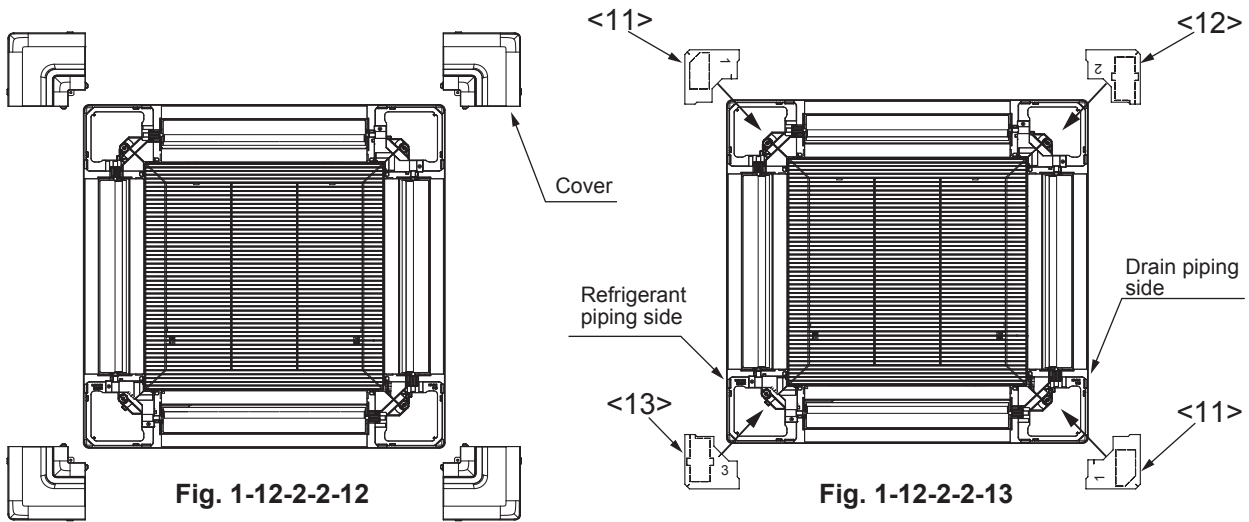
Parts mounted on ceiling panels

● Details of parts

Part name	Insulator	Insulator	Insulator	Insulator	Insulator	Insulator
Shape	<p><11></p>	<p><12></p>	<p><13></p>	<p><14></p>	<p><15></p>	<p><16></p>
No. of parts	2	1	1	2	1	1

● Procedure for attaching the parts

1. Remove the covers in the four corners. (Fig. 1-12-2-2-12)
2. Fit the ceiling panel to the indoor unit.
(For details on how the ceiling panel is to be fitted, refer to the installation instructions which are provided with the ceiling panel.)
3. Fit the insulators <11> to <13> onto the four corners of the ceiling panel exactly as shown in Fig. 1-12-2-2-13.
4. Fit the cover in place. The cover can fall off in this state so be absolutely sure to secure it in place using the fixing screws.



<When mounting the parts onto the receivers (Fig. 1-12-2-2-14)>

Cut out along the perforations the insulators <11>, <12> and/or <13> that fit the mounting location, mount them by matching them to the shape of each receiver, and attach the covers to the ceiling panel.

* Be absolutely sure to use the maximum dimensions of 910 mm x 910 mm for the extent of the ceiling opening so that the ceiling surface and insulators will not absorb any shocks.

(For details on how the ceiling panel is to be fitted, refer to the installation instructions which are provided with the ceiling panel.)

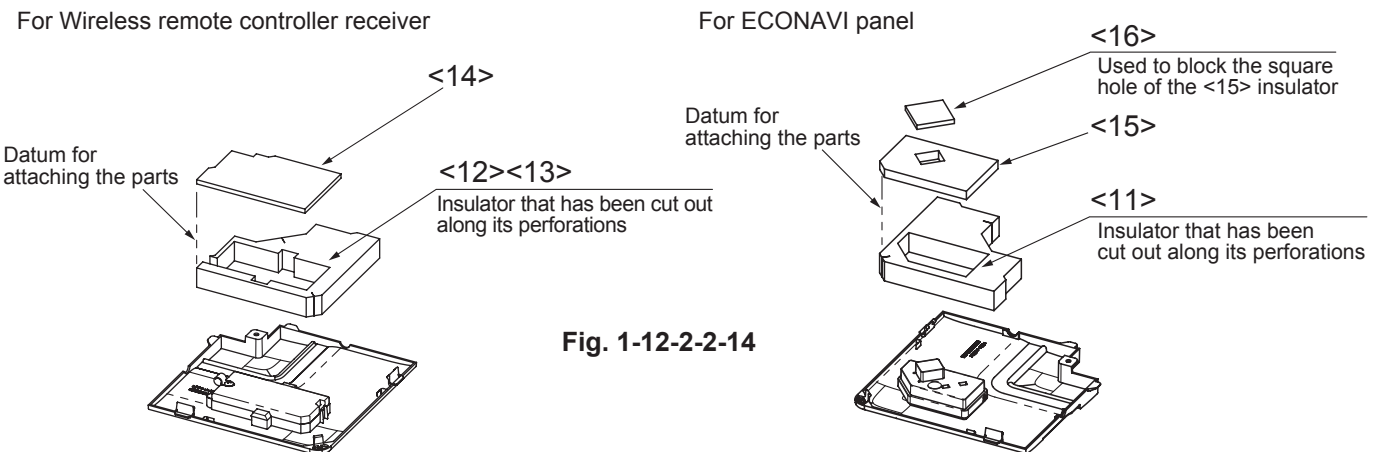


Fig. 1-12-2-2-14

1-13. Capacity Table

TC :Cooling Capacity

SHC :Sensible Heat Capacity

IPT :Cooling Power Consumption

unit : kW

High Static Pressure Ducted Type

1. Cooling capacity performance data

Model	Power Source	Ambient Return Air		Outdoor air intake temp(°C D.B.)														
				25°C			30°C			35°C			40°C			46°C		
		DB	WB	TC	SHC	IPT	TC	SHC	IPT	TC	SHC	IPT	TC	SHC	IPT	TC	SHC	IPT
S-200PE3E5B (U-200PZH2E8)	220V-230V-240V 50Hz 1phase (380V-400V-415V 50Hz 3phase)	23	16	21.1	16.6	6.11	20.8	14.0	6.80	19.3	13.4	6.66	17.4	12.5	6.32	16.2	11.9	5.85
			19	22.8	12.3	6.25	22.5	9.5	6.94	21.0	8.9	6.80	19.1	8.2	6.46	17.9	7.6	5.98
			22	24.5	7.8	6.39	24.2	5.0	7.07	22.7	4.5	6.94	20.8	3.9	6.60	19.5	3.5	6.12
		25	16	21.1	19.5	6.11	20.8	19.4	6.80	19.3	18.7	6.66	17.4	17.4	6.32	16.2	16.2	5.85
			19	22.8	15.0	6.25	22.5	14.8	6.94	21.0	14.3	6.80	19.1	13.5	6.46	17.9	13.0	5.98
			22	24.5	10.4	6.39	24.2	10.3	7.07	22.7	9.8	6.94	20.8	9.1	6.60	19.5	8.7	6.12
		27	16	21.1	21.1	6.11	20.8	20.8	6.80	19.3	19.3	6.66	17.4	17.4	6.32	16.2	16.2	5.85
			19	22.8	17.7	6.25	22.5	17.5	6.94	21.0	16.9	6.80	19.1	15.9	6.46	17.9	15.7	5.98
			22	24.5	13.1	6.39	24.2	13.0	7.07	22.7	12.4	6.94	20.8	11.5	6.60	19.5	11.3	6.12
		29	16	21.1	21.1	6.11	20.8	20.8	6.80	19.3	19.3	6.66	17.4	17.4	6.32	16.2	16.2	5.85
			19	22.8	20.3	6.25	22.5	20.2	6.94	21.0	19.6	6.80	19.1	18.9	6.46	17.9	17.9	5.98
			22	24.5	15.7	6.39	24.2	15.6	7.07	22.7	15.1	6.94	20.8	14.4	6.60	19.5	14.0	6.12
		32	16	21.1	21.1	6.11	20.8	20.8	6.80	19.3	19.3	6.66	17.4	17.4	6.32	16.2	16.2	5.85
			19	22.8	22.8	6.25	22.5	22.5	6.94	21.0	21.0	6.80	19.1	19.1	6.46	17.9	17.9	5.98
			22	24.5	19.7	6.39	24.2	19.6	7.07	22.7	18.8	6.94	20.8	18.4	6.60	19.5	17.9	6.12
S-250PE3E5B (U-250PZH2E8)	220V-230V-240V 50Hz 1phase (380V-400V-415V 50Hz 3phase)	23	16	27.2	20.7	8.27	26.7	17.4	9.20	24.8	16.2	9.02	22.4	15.4	8.56	20.8	14.7	7.91
			19	29.3	15.4	8.45	28.9	12.2	9.38	27.0	11.2	9.20	24.6	10.4	8.74	23.0	9.8	8.10
			22	31.5	10.2	8.64	31.1	6.7	9.57	29.2	6.4	9.38	26.7	5.4	8.92	25.1	4.8	8.28
		25	16	27.2	23.5	8.27	26.7	23.6	9.20	24.8	22.7	9.02	22.4	21.2	8.56	20.8	20.8	7.91
			19	29.3	18.2	8.45	28.9	18.3	9.38	27.0	17.3	9.20	24.6	16.5	8.74	23.0	15.9	8.10
			22	31.5	13.2	8.64	31.1	12.8	9.57	29.2	12.4	9.38	26.7	11.5	8.92	25.1	10.9	8.28
		27	16	27.2	26.6	8.27	26.7	26.4	9.20	24.8	24.8	9.02	22.4	22.4	8.56	20.8	20.8	7.91
			19	29.3	21.6	8.45	28.9	21.4	9.38	27.0	20.6	9.20	24.6	19.3	8.74	23.0	18.9	8.10
			22	31.5	16.2	8.64	31.1	16.1	9.57	29.2	15.5	9.38	26.7	14.5	8.92	25.1	13.9	8.28
		29	16	27.2	27.2	8.27	26.7	26.7	9.20	24.8	24.8	9.02	22.4	22.4	8.56	20.8	20.8	7.91
			19	29.3	24.4	8.45	28.9	24.4	9.38	27.0	23.4	9.20	24.6	22.6	8.74	23.0	22.0	8.10
			22	31.5	19.3	8.64	31.1	19.2	9.57	29.2	18.5	9.38	26.7	17.5	8.92	25.1	16.9	8.28
		32	16	27.2	27.2	8.27	26.7	26.7	9.20	24.8	24.8	9.02	22.4	22.4	8.56	20.8	20.8	7.91
			19	29.3	29.0	8.45	28.9	28.9	9.38	27.0	27.0	9.20	24.6	24.6	8.74	23.0	23.0	8.10
			22	31.5	23.6	8.64	31.1	23.4	9.57	29.2	23.0	9.38	26.7	21.8	8.92	25.1	21.5	8.28

2. Heating capacity performance data

TC :Heating Capacity

IPT :Heating Power Consumption

unit : kW

Model	Power Source	Ambient Return Air		Outdoor air intake temp(°C W.B.)									
				-21°C		-8°C		6°C		8°C		15°C	
		DB	WB	TC	IPT	TC	IPT	TC	IPT	TC	IPT	TC	IPT
S-200PE3E5B (U-200PZH2E8)	220V-230V-240V 50Hz 1phase (380V-400V-415V 50Hz 3phase)	16		16.0	6.37	21.9	6.89	26.3	7.51	21.7	5.06	26.5	5.12
		20		14.8	6.76	20.6	7.29	25.0	7.90	20.5	5.45	25.3	5.52
		24		13.5	7.16	19.4	7.68	23.8	8.30	19.2	5.85	24.0	5.91
S-250PE3E5B (U-250PZH2E8)	220V-230V-240V 50Hz 1phase (380V-400V-415V 50Hz 3phase)	16		18.6	7.66	25.4	8.29	30.5	9.03	25.2	6.08	30.8	6.16
		20		17.1	8.13	23.9	8.76	29.0	9.50	23.7	6.56	29.3	6.63
		24		15.7	8.61	22.5	9.24	27.6	9.98	22.3	7.03	27.9	7.11

TC :Cooling Capacity
 SHC :Sensible Heat Capacity
 IPT :Cooling Power Consumption
 unit : kW

4-Way Cassette Type

1. Cooling capacity performance data

Model	Power Source	Ambient Return Air		Outdoor air intake temp(°C D.B.)																
				25°C			30°C			35°C			40°C			46°C				
		DB	WB	TC	SHC	IPT	TC	SHC	IPT	TC	SHC	IPT	TC	SHC	IPT	TC	SHC	IPT		
S-100PU2E5Bx2 (U-200PZH2E8)	220V-230V-240V 50Hz 1phase (380V-400V-415V 50Hz 3phase)	23	16	22.5	18.5	6.38	22.2	15.5	7.10	20.6	14.8	6.96	18.6	13.9	6.60	17.2	13.3	6.11		
			19	24.3	13.9	6.52	24.0	10.9	7.24	22.4	10.1	7.10	20.4	9.5	6.75	19.0	9.0	6.25		
			22	26.1	9.2	6.67	25.8	6.3	7.38	24.2	5.8	7.24	22.2	5.1	6.89	20.8	4.7	6.39		
		25	16	22.5	21.3	6.38	22.2	21.1	7.10	20.6	20.4	6.96	18.6	18.6	6.60	17.2	17.2	6.11		
			19	24.3	16.6	6.52	24.0	16.5	7.24	22.4	15.6	7.10	20.4	15.0	6.75	19.0	14.5	6.25		
			22	26.1	11.9	6.67	25.8	11.8	7.38	24.2	11.2	7.24	22.2	10.5	6.89	20.8	10.1	6.39		
		27	16	22.5	22.5	6.38	22.2	22.2	7.10	20.6	20.6	6.96	18.6	18.6	6.60	17.2	17.2	6.11		
			19	24.3	19.4	6.52	24.0	19.3	7.24	22.4	18.6	7.10	20.4	17.8	6.75	19.0	17.1	6.25		
			22	26.1	14.7	6.67	25.8	14.6	7.38	24.2	14.0	7.24	22.2	13.3	6.89	20.8	12.8	6.39		
		29	16	22.5	22.5	6.38	22.2	22.2	7.10	20.6	20.6	6.96	18.6	18.6	6.60	17.2	17.2	6.11		
			19	24.3	22.2	6.52	24.0	22.0	7.24	22.4	21.1	7.10	20.4	20.4	6.75	19.0	19.0	6.25		
			22	26.1	17.4	6.67	25.8	17.3	7.38	24.2	16.7	7.24	22.2	16.0	6.89	20.8	15.6	6.39		
		32	16	22.5	22.5	6.38	22.2	22.2	7.10	20.6	20.6	6.96	18.6	18.6	6.60	17.2	17.2	6.11		
			19	24.3	24.3	6.52	24.0	24.0	7.24	22.4	22.4	7.10	20.4	20.4	6.75	19.0	19.0	6.25		
			22	26.1	21.6	6.67	25.8	21.4	7.38	24.2	20.9	7.24	22.2	20.2	6.89	20.8	19.4	6.39		
		S-71PU2E5Bx3 (U-200PZH2E8)	220V-230V-240V 50Hz 1phase (380V-400V-415V 50Hz 3phase)	23	16	22.5	17.8	6.38	22.2	15.1	7.10	20.6	14.4	6.96	18.6	13.4	6.60	17.2	12.7	6.11
					19	24.3	13.3	6.52	24.0	10.8	7.24	22.4	10.2	7.10	20.4	9.4	6.75	19.0	8.9	6.25
					22	26.1	9.2	6.67	25.8	6.5	7.38	24.2	5.8	7.24	22.2	5.3	6.89	20.8	4.8	6.39
25	16			22.5	20.4	6.38	22.2	20.3	7.10	20.6	19.5	6.96	18.6	18.6	6.60	17.2	17.3	6.11		
	19			24.3	16.1	6.52	24.0	15.9	7.24	22.4	15.3	7.10	20.4	14.5	6.75	19.0	13.7	6.25		
	22			26.1	11.7	6.67	25.8	11.6	7.38	24.2	10.8	7.24	22.2	10.3	6.89	20.8	9.9	6.39		
27	16			22.5	22.6	6.38	22.2	22.3	7.10	20.6	20.7	6.96	18.6	18.7	6.60	17.2	17.3	6.11		
	19			24.3	18.4	6.52	24.0	18.5	7.24	22.4	17.6	7.10	20.4	17.0	6.75	19.0	16.5	6.25		
	22			26.1	14.3	6.67	25.8	14.1	7.38	24.2	13.6	7.24	22.2	12.9	6.89	20.8	12.4	6.39		
29	16			22.5	22.6	6.38	22.2	22.3	7.10	20.6	20.7	6.96	18.6	18.7	6.60	17.2	17.3	6.11		
	19			24.3	21.2	6.52	24.0	21.0	7.24	22.4	20.4	7.10	20.4	19.6	6.75	19.0	18.8	6.25		
	22			26.1	16.8	6.67	25.8	16.6	7.38	24.2	15.9	7.24	22.2	15.3	6.89	20.8	14.9	6.39		
32	16			22.5	22.7	6.38	22.2	22.3	7.10	20.6	20.7	6.96	18.6	18.7	6.60	17.2	17.3	6.11		
	19			24.3	24.5	6.52	24.0	24.1	7.24	22.4	22.5	7.10	20.4	20.5	6.75	19.0	19.1	6.25		
	22			26.1	20.6	6.67	25.8	20.4	7.38	24.2	19.8	7.24	22.2	19.1	6.89	20.8	18.7	6.39		
S-50PU2E5Bx4 U-200PZH2E8	220V-230V-240V 50Hz 1phase (380V-400V-415V 50Hz 3phase)			23	16	22.5	17.8	6.38	22.2	15.1	7.10	20.6	14.4	6.96	18.6	13.4	6.60	17.2	12.9	6.11
					19	24.3	13.3	6.52	24.0	10.8	7.24	22.4	10.2	7.10	20.4	9.4	6.75	19.0	8.9	6.25
					22	26.1	9.2	6.67	25.8	6.5	7.38	24.2	5.8	7.24	22.2	5.3	6.89	20.8	4.8	6.39
		25	16	22.5	20.4	6.38	22.2	20.3	7.10	20.6	19.5	6.96	18.6	18.6	6.60	17.2	17.2	6.11		
			19	24.3	16.1	6.52	24.0	15.9	7.24	22.4	15.3	7.10	20.4	14.5	6.75	19.0	13.7	6.25		
			22	26.1	11.7	6.67	25.8	11.6	7.38	24.2	10.8	7.24	22.2	10.3	6.89	20.8	9.9	6.39		
		27	16	22.5	22.5	6.38	22.2	22.2	7.10	20.6	20.6	6.96	18.6	18.6	6.60	17.2	17.2	6.11		
			19	24.3	18.4	6.52	24.0	18.5	7.24	22.4	17.6	7.10	20.4	17.0	6.75	19.0	16.5	6.25		
			22	26.1	14.3	6.67	25.8	14.1	7.38	24.2	13.6	7.24	22.2	12.9	6.89	20.8	12.4	6.39		
		29	16	22.5	22.5	6.38	22.2	22.2	7.10	20.6	20.6	6.96	18.6	18.6	6.60	17.2	17.2	6.11		
			19	24.3	21.2	6.52	24.0	21.0	7.24	22.4	20.4	7.10	20.4	19.6	6.75	19.0	18.8	6.25		
			22	26.1	16.8	6.67	25.8	16.6	7.38	24.2	15.9	7.24	22.2	15.3	6.89	20.8	14.9	6.39		
		32	16	22.5	22.5	6.38	22.2	22.2	7.10	20.6	20.6	6.96	18.6	18.6	6.60	17.2	17.2	6.11		
			19	24.3	24.3	6.52	24.0	24.0	7.24	22.4	22.4	7.10	20.4	20.4	6.75	19.0	19.0	6.25		
			22	26.1	20.6	6.67	25.8	20.4	7.38	24.2	19.8	7.24	22.2	19.1	6.89	20.8	18.7	6.39		
		S-125PU2E5Bx2 U-250PZH2E8	220V-230V-240V 50Hz 1phase (380V-400V-415V 50Hz 3phase)	23	16	28.2	21.4	8.74	27.7	18.0	9.72	25.8	17.4	9.53	23.2	16.2	9.04	21.6	15.4	8.36
					19	30.4	16.2	8.93	30.0	13.4	9.91	28.0	12.6	9.72	25.5	11.6	9.23	23.8	10.9	8.55
					22	32.6	11.6	9.13	32.2	8.6	10.11	30.2	7.9	9.91	27.7	6.7	9.43	26.0	6.3	8.75
25	16			28.2	24.0	8.74	27.7	23.8	9.72	25.8	22.9	9.53	23.2	22.0	9.04	21.6	20.9	8.36		
	19			30.4	19.3	8.93	30.0	18.9	9.91	28.0	18.3	9.72	25.5	17.3	9.23	23.8	16.6	8.55		
	22			32.6	14.2	9.13	32.2	14.3	10.11	30.2	13.6	9.91	27.7	12.3	9.43	26.0	12.0	8.75		
27	16			28.2	27.2	8.74	27.7	26.9	9.72	25.8	25.9	9.53	23.2	23.4	9.04	21.6	21.6	8.36		
	19			30.4	22.3	8.93	30.0	22.0	9.91	28.0	20.9	9.72	25.5	19.9	9.23	23.8	19.4	8.55		
	22			32.6	17.3	9.13	32.2	16.9	10.11	30.2	16.1	9.91	27.7	15.4	9.43	26.0	14.8	8.75		
29	16			28.2	28.3	8.74	27.7	27.8	9.72	25.8	25.9	9.53	23.2	23.3	9.04	21.6	21.7	8.36		
	19			30.4	25.1	8.93	30.0	24.9	9.91	28.0	24.0	9.72	25.5	23.0	9.23	23.8	22.3	8.55		
	22			32.6	19.9	9.13	32.2	20.0	10.11	30.2	19.2	9.91	27.7	18.0	9.43	26.0	17.6	8.75		
32	16			28.2	28.3	8.74	27.7	27.8	9.72	25.8	25.9	9.53	23.2	23.3	9.04	21.6	21.7	8.36		
	19			30.4	29.1	8.93	30.0	29.0	9.91	28.0	28.1	9.72	25.5	25.6	9.23	23.8	23.9	8.55		
	22			32.6	24.5	9.13	32.2	24.2	10.11	30.2	23.5	9.91	27.7	22.5	9.43	26.0	21.9	8.75		
S-60PU2E5Bx4 U-250PZH2E8	220V-230V-240V 50Hz 1phase (380V-400V-415V 50Hz 3phase)			23	16	28.2	22.4	8.74	27.7	19.0	9.72	25.8	18.0	9.53	23.2	16.9	9.04	21.6	16.2	8.36
					19	30.4	17.0	8.93	30.0	13.5	9.91	28.0	12.7	9.72	25.5	11.7	9.23	23.8	11.1	8.55
					22	32.6	11.5	9.13	32.2	8.1	10.11	30.2	7.4	9.91	27.7	6.6	9.43	26.0	6.0	8.75
		25	16	28.2	25.7	8.74	27.7	25.5	9.72	25.8	24.6	9.53	23.2	23.2	9.04	21.6	21.6	8.36		
			19	30.4	20.2	8.93	30.0	20.0	9.91	28.0	19.2	9.72	25.5	18.2	9.23	23.8	17.5	8.55		
			22	32.6	14.7	9.13	32.2	14.5	10.11	30.2	13.8	9.91	27.7	13.0	9.43	26.0	12.4	8.75		
		27	16	28.2	28.2	8.74	27.7	27.7	9.72	25.8	25.8	9.53	23.2	23.2	9.04	21.6	21.6	8.36		
			19	30.4	23.4	8.93	30.0	23.2	9.91	28.0	22.5	9.72	25.5	21.5	9.23	23.8	2			

2. Heating capacity performance data

TC :Heating Capacity

IPT :Heating Power Consumption

unit : kW

Model	Power Source	Ambient Return Air DB	Outdoor air intake temp(°C W.B.)									
			-21°C		-8°C		6°C		8°C		15°C	
			TC	IPT	TC	IPT	TC	IPT	TC	IPT	TC	IPT
S-100PU2E5B×2 (U-200PZH2E8)	220V-230V-240V 50Hz 1phase (380V-400V-415V 50Hz 3phase)	16	16.0	6.37	21.9	6.89	26.3	7.51	21.7	5.06	26.5	5.12
		20	14.8	6.76	20.6	7.29	25.0	7.90	20.5	5.45	25.3	5.52
		24	13.5	7.16	19.4	7.68	23.8	8.30	19.2	5.85	24.0	5.91
S-71PU2E5B×3 (U-200PZH2E8)	220V-230V-240V 50Hz 1phase (380V-400V-415V 50Hz 3phase)	16	16.0	6.37	21.9	6.89	26.3	7.51	21.7	5.06	26.5	5.12
		20	14.8	6.76	20.6	7.29	25.0	7.90	20.5	5.45	25.3	5.52
		24	13.5	7.16	19.4	7.68	23.8	8.30	19.2	5.85	24.0	5.91
S-50PU2E5B×4 (U-200PZH2E8)	220V-230V-240V 50Hz 1phase (380V-400V-415V 50Hz 3phase)	16	16.0	6.37	21.9	6.89	26.3	7.51	21.7	5.06	26.5	5.12
		20	14.8	6.76	20.6	7.29	25.0	7.90	20.5	5.45	25.3	5.52
		24	13.5	7.16	19.4	7.68	23.8	8.30	19.2	5.85	24.0	5.91
S-125PU2E5B×2 (U-250PZH2E8)	220V-230V-240V 50Hz 1phase (380V-400V-415V 50Hz 3phase)	16	20.2	8.14	27.5	8.81	33.1	9.60	27.4	6.47	33.4	6.55
		20	18.6	8.65	26.0	9.32	31.5	10.1	25.8	6.97	31.9	7.05
		24	17.0	9.15	24.4	9.82	29.9	10.6	24.2	7.48	30.3	7.56
S-60PU2E5B×4 (U-250PZH2E8)	220V-230V-240V 50Hz 1phase (380V-400V-415V 50Hz 3phase)	16	20.2	8.14	27.5	8.81	33.1	9.60	27.4	6.47	33.4	6.55
		20	18.6	8.65	26.0	9.32	31.5	10.1	25.8	6.97	31.9	7.05
		24	17.0	9.15	24.4	9.82	29.9	10.6	24.2	7.48	30.3	7.56

Information requirements for air-to-air air conditioners

Model(s): Outdoor Unit U-200PZH2E8
Indoor Unit S-200PE3E5B

Outdoor side heat exchanger of air conditioner:
Indoor side heat exchanger of air conditioner:
Type: compressor driven vapour compression or sorption process
if applicable: driver of compressor: [electric motor or fuel driven,
gaseous or liquid fuel, internal or external combustion engine]

air
air
vapour compression
electric motor

Item	Symbol	Value	Unit	Item	Symbol	Value	Unit
Rated cooling capacity	$P_{rated,c}$	19.5	kW	Seasonal space cooling energy efficiency	$\eta_{p,c}$	207.0	%
Refrigeration load	$P_{design,r}$	19.5	kW	Declared energy efficiency ratio or gas utilization efficiency / auxiliary energy factor for part load at given outdoor temperatures Tj and indoor 27°/19°C (dry/wet bulb) Tj			
Declared cooling capacity for part load at given outdoor temperatures Tj and indoor 27°/19°C (dry/wet bulb)							
Tj = +35 °C		19.5	kW	Tj = +35 °C	EER _o or GUE _{o,brn} / AEF _{o,brn}	3.2	%
Tj = +30 °C		14.3	kW	Tj = +30 °C		4.5	%
Tj = +25 °C	P_{dc}	9.2	kW	Tj = +25 °C		6.4	%
Tj = +20 °C		6.4	kW	Tj = +20 °C		7.4	%
Degradation co-efficient for air conditioners**	C_{dc}	0.25	-				
Power consumption in modes other than 'active mode'							
Off mode	P_{off}	0.021	kW	Crankcase heater mode	P_{ck}	0.009	kW
Thermostat-off mode	P_{to}	0.103	kW	Standby mode	P_{sb}	0.021	kW
Other items							
Capacity control		variable		For air-to-air air conditioner: air flow rate, outdoor		9840	m³/h
Sound power level, outdoor	L_{wa}	77.0	dB				
Sound power level, indoor	L_{wa}	78.0	dB	if engine driven: Emissions of nitrogen oxides	NO_{x}^{***}	-	mg/kWh fuel input GCV
				GWP of the refrigerant		675	kg CO ₂ eq (100 years)
Contact details	Panasonic Testing Centre, Panasonic Marketing Europe GmbH Winsbeigring 15, 22525 Hamburg, Germany						
** If C_{dc} is not determined by measurement then the default degradation coefficient air conditioners shall be 0.25. *** from 26 September 2018. Where information relates to multi-split air conditioners, the test result and performance data may be obtained on the basis of the performance of the outdoor unit, with a combination of indoor unit(s) recommended by the manufacturer or importer. **** Refer to Information requirements for UnitIt							

Information requirements for heat pumps

Model(s): Outdoor Unit U-200PZH2E8
Indoor Unit S-200PE3E5B

Outdoor side heat exchanger of heat pump:
Indoor side heat exchanger of heat pump:
Indication if the heater is equipped with a supplementary heater:
if applicable: driver of compressor: [electric motor or fuel driven,
gaseous or liquid fuel, internal or external combustion engine]

Parameters shall be declared for the average heating season, parameters for the warmer and colder heating seasons are optional.

air
air
no
electric motor

Item	Symbol	Value	Unit	Item	Symbol	Value	Unit
Rated heating capacity	$P_{rated,h}$	22.4	kW	Seasonal space heating energy efficiency	$\eta_{p,h}$	141.3	%
Refrigeration load	$P_{design,h}$	17.0	kW	Declared coefficient of performance or gas utilization efficiency / auxiliary energy factor for part load at given outdoor temperatures Tj			
Declared heating capacity for part load at indoor temperature 20 °C and outdoor temperature Tj							
Tj = -7 °C		15.0	kW	Tj = -7 °C		2.6	%
Tj = +2 °C		9.7	kW	Tj = +2 °C		3.4	%
Tj = +7 °C		5.9	kW	Tj = +7 °C		4.7	%
Tj = +12 °C		6.4	kW	Tj = +12 °C		5.8	%
T_{bw} = bivalent temperature	P_{bh}	17.0	kW	T_{bw} = bivalent temperature	COP _o of GUE _{o,brn} / AEF _{o,brn}	2.4	%
T_{col} = operation limit		13.6	kW	T_{col} = operation limit		2.0	%
For air-to-water heat pumps: Tj = -15 °C (if T_{col} < -20 °C)		-	kW	For water-to-air heat pumps: Tj = -15 °C (if T_{col} < -20 °C)		-	%
Bivalent temperature	T_{bv}	-10	°C	For water-to-air heat pumps: Operation limit temperature	T_{col}	-20	°C
Degradation co-efficient heat pumps**	C_{dh}	0.25	-				
Power consumption in modes other than 'active mode'							
Off mode	P_{off}	0.021	kW	Supplementary heater back-up heating capacity *	eibu	0.0	kW
Thermostat-off mode	P_{to}	0.150	kW	Type of energy input			
Crankcase heater mode	P_{ck}	0.009	kW	Standby mode	P_{sb}	0.021	kW
Other items							
Capacity control		variable		For air-to-air heat pumps: air flow rate, outdoor		9840	m³/h
Sound power level, outdoor	L_{wa}	79.0	dB	For water-/brine-to-air heat pumps: Rated brine or water flow rate, outdoor side heat exchanger		-	m³/h
Sound power level, indoor	L_{wa}	78.0	dB	Emissions of nitrogen oxides (if applicable)	NO_{x}^{***}	-	mg/kWh fuel input GCV
				GWP of the refrigerant		675	kg CO ₂ eq (100 years)
Contact details	Panasonic Testing Centre, Panasonic Marketing Europe GmbH Winsbeigring 15, 22525 Hamburg, Germany						
** If C_{dh} is not determined by measurement then the default degradation coefficient of heat pumps shall be 0.25. *** from 26 September 2018. Where information relates to multi-split heat pumps, the test result and performance data may be obtained on the basis of the performance of the outdoor unit, with a combination of indoor unit(s) recommended by the manufacturer or importer. **** Refer to Information requirements for UnitIt							

Information requirements for air-to-air air conditioners

Model(s):		Outdoor Unit Indoor Unit		U-250PZH2E8 S-250PE3E5B	
Outdoor side heat exchanger of air conditioner:		air			
Indoor side heat exchanger of air conditioner:		air			
Type: compressor driven vapour compression or sorption process		vapour compression			
if applicable: driver of compressor: [electric motor or fuel driven, gaseous or liquid fuel, internal or external combustion engine]		electric motor			

Item	Symbol	Value	Unit	Item	Symbol	Value	Unit
Rated cooling capacity	$P_{f,elec}$	23.2	kW	Seasonal space cooling energy efficiency	$\eta_{p,c}$	190.6	%
Refrigeration load	$P_{design,c}$	23.2	kW	Declared energy efficiency ratio or gas utilization efficiency / auxiliary energy factor for part load at given outdoor temperatures Tj and indoor 27°/19°C (dry/wet bulb) Tj			
Tj = +35 °C		23.2	kW	Tj = +35 °C		3.1	%
Tj = +30 °C		17.1	kW	Tj = +30 °C	EER _s or GUE _{h,bln} / AEF _{h,bln}	4.3	%
Tj = +25 °C	P _{dc}	11.0	kW	Tj = +25 °C		5.8	%
Tj = +20 °C		6.9	kW	Tj = +20 °C		6.4	%
Degradation co-efficient for air conditioners**	C _{dc}	0.25	-				
Declared cooling capacity for part load at given outdoor temperatures Tj and indoor 27°/19°C (dry/wet bulb)							
Power consumption in modes other than 'active mode'							
Off mode	P _{off}	0.028	kW	Crankcase heater mode	P _{ck}	0.010	kW
Thermostat-off mode	P _{to}	0.130	kW	Standby mode	P _{sb}	0.028	kW
Other items							
Capacity control		variable		For air-to-air air conditioner: air flow rate, outdoor		9600	m³/h
Sound power level, outdoor	L _{wa}	78.0	dB				
Sound power level, indoor	L _{wa}	79.0	dB	if engine driven: Emissions of nitrogen oxides	NO _x **	-	mg/KWh fuel input GCV
				GWP of the refrigerant		675	kg CO ₂ eq (100 years)
Contact details		Panasonic Testing Centre, Panasonic Marketing Europe GmbH Winsbergring 15, 22525 Hamburg, Germany					
** If C _{dc} is not determined by measurement then the default degradation coefficient air conditioners shall be 0.25.							
*** from 26 September 2018.							
Where information relates to multi-split air conditioners, the test result and performance data may be obtained on the basis of the performance of the outdoor unit, with a combination of indoor unit(s) recommended by the manufacturer or importer.							
**** Refer to information requirements for UnitList							

Information requirements for heat pumps

Model(s):		Outdoor Unit Indoor Unit		U-250PZH2E8 S-250PE3E5B	
Outdoor side heat exchanger of heat pump:		air			
Indoor side heat exchanger of heat pump:		air			
Indication if the heater is equipped with a supplementary heater: if applicable: driver of compressor: [electric motor or fuel driven, gaseous or liquid fuel, internal or external combustion engine]		no		electric motor	
Parameters shall be declared for the average heating season, parameters for the warmer and colder heating seasons are optional.					

Item	Symbol	Value	Unit	Item	Symbol	Value	Unit
Rated heating capacity	$P_{rated,h}$	28.0	kW	Seasonal space heating energy efficiency	$\eta_{h,h}$	142.7	%
Refrigeration load	$P_{design,h}$	20.0	kW	Declared coefficient of performance or gas utilization efficiency / auxiliary energy factor for part load at given outdoor temperatures Tj			
Declared heating capacity for part load at indoor temperature 20 °C and outdoor temperature Tj							
Tj = -7 °C		17.7	kW	Tj = -7 °C		2.5	%
Tj = +2 °C		10.8	kW	Tj = +2 °C		3.4	%
Tj = +7 °C		6.9	kW	Tj = +7 °C		5.2	%
Tj = +12 °C		6.5	kW	Tj = +12 °C		5.2	%
T _{hw} = bivalent temperature	P _{ah}	20.0	kW	T _{hw} = bivalent temperature	COP _s or GUE _{h,bln} / AEF _{h,bln}	2.3	%
T _{ol} = operation limit		15.7	kW	T _{ol} = operation limit		1.8	%
For air-to-water heat pumps: Tj = -15 °C (if T _{ol} < -20 °C)		-	kW	For water-to-air heat pumps: Tj = -15 °C (if T _{ol} < -20 °C)		-	%
Bivalent temperature	T _{bw}	-10	°C	For water-to-air heat pumps: Operation limit temperature	T _{ol}	-20	°C
Degradation co-efficient heat pumps**	C _{ah}	0.25	-				
Power consumption in modes other than 'active mode'							
Off mode	P _{off}	0.028	kW	Supplementary heater			
Thermostat-off mode	P _{to}	0.186	kW	back-up heating capacity *	e _{ibu}	0.0	kW
Crankcase heater mode	P _{ck}	0.010	kW	Type of energy input			
Other items							
Capacity control		variable		For air-to-air heat pumps: air flow rate, outdoor		9600	m³/h
Sound power level, outdoor	L _{wa}	82.0	dB	For water-/brine-to-air heat pumps: Rated brine or water flow rate, outdoor side heat exchanger		-	m³/h
Sound power level, indoor	L _{wa}	79.0	dB	Emissions of nitrogen oxides (if applicable)	NO _x **	-	mg/KWh fuel input GCV
				GWP of the refrigerant		675	kg CO ₂ eq (100 years)
Contact details		Panasonic Testing Centre, Panasonic Marketing Europe GmbH Winsbergring 15, 22525 Hamburg, Germany					
** If C _{ah} is not determined by measurement then the default degradation coefficient of heat pumps shall be 0.25.							
*** from 26 September 2018.							
Where information relates to multi-split heat pumps, the test result and performance data may be obtained on the basis of the performance of the outdoor unit, with a combination of indoor unit(s) recommended by the manufacturer or importer.							
**** Refer to information requirements for UnitList							

Information requirements for air-to-air air conditioners

Model(s):	Outdoor Unit Indoor Unit	U-200PZH2E8 S-100PU2E5Bx2
Outdoor side heat exchanger of air conditioner:	air	
Indoor side heat exchanger of air conditioner:	air	
Type: compressor driven vapour compression or sorption process	vapour compression	
if applicable: driver of compressor: [electric motor or fuel driven, gaseous or liquid fuel, internal or external combustion engine]	electric motor	

Item	Symbol	Value	Unit	Item	Symbol	Value	Unit
Rated cooling capacity	P _{rated,c}	20.0	kW	Seasonal space cooling energy efficiency	η _{p,c}	326.2	%
Refrigeration load	P _{design,r,c}	20.0	kW	Declared energy efficiency ratio or gas utilization efficiency / auxiliary energy factor for part load at given outdoor temperatures T _j			
Declared cooling capacity for part load at given outdoor temperatures T _j and indoor 27°/19°C (dry/wet bulb)							
T _j = + 35 °C		20.0	kW	T _j = + 35 °C		3.5	%
T _j = + 30 °C		14.7	kW	T _j = + 30 °C	EER _o or GUE _{o,bin} / AEF _{o,bin}	5.6	%
T _j = + 25 °C	P _{dc}	9.5	kW	T _j = + 25 °C		10.3	%
T _j = + 20 °C		6.9	kW	T _j = + 20 °C		19.1	%
Degradation co- efficient for air conditioners**	C _{dc}	0.25	-				
Power consumption in modes other than 'active mode'							
Off mode	P _{OFF}	0.020	kW	Crankcase heater mode	P _{CH}	0.010	kW
Thermostat-off mode	P _{TO}	0.020	kW	Standby mode	P _{SB}	0.020	kW
Other items							
Capacity control		variable		For air-to-air air conditioner: air flow rate, outdoor		9840	m ³ /h
Sound power level, outdoor	L _{WA}	77.0	dB				
Sound power level, indoor	L _{WA}	60.0	dB	if engine driven: Emissions of nitrogen oxides	NO _x ***	-	mg/kWh fuel input GCV
				GWP of the refrigerant		675	kg CO ₂ eq (100 years)
Contact details	Panasonic Testing Centre, Germany			Panasonic Marketing Europe GmbH Winsbergiring 15, 22525 Hamburg, Germany			

** If C_{dc} is not determined by measurement then the default degradation coefficient air conditioners shall be 0.25.
 *** from 26 September 2018.
 Where information relates to multi-split air conditioners, the test result and performance data may be obtained on the basis of the performance of the outdoor unit, with a combination of indoor unit(s) recommended by the manufacturer or importer.
 **** Refer to information requirements for UnitList

Information requirements for heat pumps

Model(s):	Outdoor Unit Indoor Unit	U-200PZH2E8 S-100PU2E5Bx2
Outdoor side heat exchanger of heat pump:	air	
Indoor side heat exchanger of heat pump:	air	
Indication if the heater is equipped with a supplementary heater: if applicable: driver of compressor: [electric motor or fuel driven, gaseous or liquid fuel, internal or external combustion engine]	no	
Parameters shall be declared for the average heating season, parameters for the warmer and colder heating seasons are optional.	electric motor	

Item	Symbol	Value	Unit	Item	Symbol	Value	Unit
Rated heating capacity	P _{rated,h}	22.4	kW	Seasonal space heating energy efficiency	η _{p,h}	182.3	%
Refrigeration load	P _{design,r,h}	18.0	kW	Declared coefficient of performance or gas utilization efficiency / auxiliary energy factor for part load at given outdoor temperatures T _j			
Declared heating capacity for part load at indoor temperature 20 °C and outdoor temperature T _j							
T _j = - 7 °C		15.9	kW	T _j = - 7 °C		2.8	%
T _j = + 2 °C		9.7	kW	T _j = + 2 °C		4.1	%
T _j = + 7 °C		6.3	kW	T _j = + 7 °C		7.4	%
T _j = + 12 °C		6.0	kW	T _j = + 12 °C		9.6	%
T _{hw} = bivalent temperature	P _{th}	18.0	kW	T _{hw} = bivalent temperature	GUE _{o,bin} / AEF _{o,bin}	2.6	%
T _{co} = operation limit		12.3	kW	T _{co} = operation limit		2.1	%
For air-to-water heat pumps: T _j = - 15 °C (if T _{co} < - 20 °C)		-	kW	For water-to-air heat pumps: T _j = - 15 °C (if T _{co} < - 20 °C)		-	%
Bivalent temperature	T _{bw}	-10	°C	For water-to-air heat pumps: Operation limit temperature	T _{co}	-20	°C
Degradation co- efficient heat pumps**	C _{dh}	0.25	-				
Power consumption in modes other than 'active mode'							
Off mode	P _{OFF}	0.020	kW	Supplementary heater back-up heating capacity *	elbu	0.0	kW
Thermostat-off mode	P _{TO}	0.020	kW	Type of energy input			
Crankcase heater mode	P _{CH}	0.010	kW	Standby mode	P _{SB}	0.020	kW
Other items							
Capacity control		variable		For air-to-air heat pumps: air flow rate, outdoor		9840	m ³ /h
Sound power level, outdoor	L _{WA}	79.0	dB	For water-/brine-to-air heat pumps: Rated brine or water flow rate, outdoor side heat exchanger		-	m ³ /h
Sound power level, indoor	L _{WA}	60.0	dB	Emissions of nitrogen oxides (if applicable)	NO _x ***	-	mg/kWh fuel input GCV
				GWP of the refrigerant		675	kg CO ₂ eq (100 years)
Contact details	Panasonic Testing Centre, Germany			Panasonic Marketing Europe GmbH Winsbergiring 15, 22525 Hamburg, Germany			

** If C_{dh} is not determined by measurement then the default degradation coefficient of heat pumps shall be 0.25.
 *** from 26 September 2018.
 Where information relates to multi-split heat pumps, the test result and performance data may be obtained on the basis of the performance of the outdoor unit, with a combination of indoor unit(s) recommended by the manufacturer or importer.
 **** Refer to information requirements for UnitList

Information requirements for air-to-air air conditioners

Model(s):	Outdoor Unit Indoor Unit	U-200PZH2E8 S-71PU2E5Bx3
Outdoor side heat exchanger of air conditioner:	air	
Indoor side heat exchanger of air conditioner:	air	
Type: compressor driven vapour compression or sorption process	vapour compression	
if applicable: driver of compressor: [electric motor or fuel driven, gaseous or liquid fuel, internal or external combustion engine]	electric motor	

Information requirements for heat pumps

Model(s):	Outdoor Unit Indoor Unit	U-200PZH2E8 S-71PU2E5Bx3
Outdoor side heat exchanger of heat pump:	air	
Indoor side heat exchanger of heat pump:	air	
Indication if the heater is equipped with a supplementary heater:	no	
if applicable: driver of compressor: [electric motor or fuel driven, gaseous or liquid fuel, internal or external combustion engine]	electric motor	
Parameters shall be declared for the average heating season, parameters for the warmer and colder heating seasons are optional.		

Item	Symbol	Value	Unit	Item	Symbol	Value	Unit
Rated cooling capacity	$P_{rated,c}$	20.0	kW	Seasonal space cooling energy efficiency	$\eta_{p,c}$	326.2	%
Refrigeration load	$P_{design,c}$	20.0	kW	Declared energy efficiency ratio or gas utilization efficiency / auxiliary energy factor for part load at given outdoor temperatures			
Declared cooling capacity for part load at given outdoor temperatures T_{jand} indoor $27^{\circ}/19^{\circ}\text{C}$ (dry/wet bulb)							
$T_j = +35^{\circ}\text{C}$		20.0	kW	$T_j = +35^{\circ}\text{C}$		3.5	%
$T_j = +30^{\circ}\text{C}$		14.7	kW	$T_j = +30^{\circ}\text{C}$	EER _o or GUE _{o,bin} / AEF _{o,bin}	5.6	%
$T_j = +25^{\circ}\text{C}$	P_{dc}	9.5	kW	$T_j = +25^{\circ}\text{C}$		10.3	%
$T_j = +20^{\circ}\text{C}$		6.9	kW	$T_j = +20^{\circ}\text{C}$		19.1	%
Degradation co-efficient for air conditioners**	C_{dc}	0.25	-	Declared heating capacity for part load at indoor temperature 20 °C and outdoor temperature T_j			
Declared heating capacity for part load at indoor temperature 20 °C and outdoor temperature T_j							
$T_j = -7^{\circ}\text{C}$		15.9	kW	$T_j = -7^{\circ}\text{C}$		2.8	%
$T_j = +2^{\circ}\text{C}$		9.7	kW	$T_j = +2^{\circ}\text{C}$		4.1	%
$T_j = +7^{\circ}\text{C}$		6.3	kW	$T_j = +7^{\circ}\text{C}$		7.4	%
$T_j = +12^{\circ}\text{C}$		6.0	kW	$T_j = +12^{\circ}\text{C}$		9.6	%
$T_{bw} = \text{bivalent temperature}$	P_{bh}	18.0	kW	$T_{bw} = \text{bivalent temperature}$	COP _o of GUE _{o,bin} / AEF _{o,bin}	2.6	%
$T_{co} = \text{operation limit}$		12.3	kW	$T_{co} = \text{operation limit}$		2.1	%
For air-to-water heat pumps: $T_j = -15^{\circ}\text{C}$ (if $T_{co} < -20^{\circ}\text{C}$)		-	kW	For water-to-air heat pumps: $T_j = -15^{\circ}\text{C}$ (if $T_{co} < -20^{\circ}\text{C}$)		-	%
Bivalent temperature	T_{biv}	-10	°C	For water-to-air heat pumps: Operation limit temperature	T_{co}	-20	°C
Degradation co-efficient heat pumps**	C_{dh}	0.25	-	Power consumption in modes other than 'active mode'			
Power consumption in modes other than 'active mode'							
Off mode	P_{off}	0.020	kW	Crankcase heater mode	P_{ck}	0.010	kW
Thermostat-off mode	P_{to}	0.020	kW	Standby mode	P_{sb}	0.020	kW
Other items							
Capacity control		variable		For air-to-air air conditioner: air flow rate, outdoor		9840	m ³ /h
Sound power level, outdoor	L_{WA}	77.0	dB				
Sound power level, indoor	L_{WA}	52.0	dB	if engine driven: Emissions of nitrogen oxides	NO_x^{***}	-	mg/kWh fuel input GCV
				GWP of the refrigerant		675	kg CO ₂ eq (100 years)
Contact details	Panasonic Testing Centre, Germany			Panasonic Marketing Europe GmbH Winsbergiring 15, 22525 Hamburg, Germany			

Item	Symbol	Value	Unit	Item	Symbol	Value	Unit
Rated heating capacity	$P_{rated,h}$	22.4	kW	Seasonal space heating energy efficiency	$\eta_{p,h}$	182.3	%
Refrigeration load	$P_{design,h}$	18.0	kW	Declared coefficient of performance or gas utilization efficiency / auxiliary energy factor for part load at given outdoor temperatures			
Declared heating capacity for part load at indoor temperature 20 °C and outdoor temperature T_j							
$T_j = -7^{\circ}\text{C}$		15.9	kW	$T_j = -7^{\circ}\text{C}$		2.8	%
$T_j = +2^{\circ}\text{C}$		9.7	kW	$T_j = +2^{\circ}\text{C}$		4.1	%
$T_j = +7^{\circ}\text{C}$		6.3	kW	$T_j = +7^{\circ}\text{C}$		7.4	%
$T_j = +12^{\circ}\text{C}$		6.0	kW	$T_j = +12^{\circ}\text{C}$		9.6	%
$T_{bw} = \text{bivalent temperature}$	P_{bh}	18.0	kW	$T_{bw} = \text{bivalent temperature}$	COP _o of GUE _{o,bin} / AEF _{o,bin}	2.6	%
$T_{co} = \text{operation limit}$		12.3	kW	$T_{co} = \text{operation limit}$		2.1	%
For air-to-water heat pumps: $T_j = -15^{\circ}\text{C}$ (if $T_{co} < -20^{\circ}\text{C}$)		-	kW	For water-to-air heat pumps: $T_j = -15^{\circ}\text{C}$ (if $T_{co} < -20^{\circ}\text{C}$)		-	%
Bivalent temperature	T_{biv}	-10	°C	For water-to-air heat pumps: Operation limit temperature	T_{co}	-20	°C
Degradation co-efficient heat pumps**	C_{dh}	0.25	-	Power consumption in modes other than 'active mode'			
Power consumption in modes other than 'active mode'							
Off mode	P_{off}	0.020	kW	back-up heating capacity*	e_{bu}	0.0	kW
Thermostat-off mode	P_{to}	0.020	kW	Type of energy input			
Crankcase heater mode	P_{ck}	0.010	kW	Standby mode	P_{sb}	0.020	kW
Other items							
Capacity control		variable		For air-to-air heat pumps: air flow rate, outdoor		9840	m ³ /h
Sound power level, outdoor	L_{WA}	79.0	dB	For water-/brine-to-air heat pumps: Rated brine or water flow rate, outdoor side heat exchanger		-	m ³ /h
Sound power level, indoor	L_{WA}	52.0	dB	Emissions of nitrogen oxides (if applicable)	NO_x^{***}	-	mg/kWh fuel input GCV
				GWP of the refrigerant		675	kg CO ₂ eq (100 years)
Contact details	Panasonic Testing Centre, Germany			Panasonic Marketing Europe GmbH Winsbergiring 15, 22525 Hamburg, Germany			

** If C_{dc} is not determined by measurement then the default degradation coefficient of air conditioners shall be 0.25.
 *** from 26 September 2018.
 Where information relates to multi-split air conditioners, the test result and performance data may be obtained on the basis of the performance of the outdoor unit, with a combination of indoor unit(s) recommended by the manufacturer or importer.
 **** Refer to information requirements for UnitList

Information requirements for air-to-air air conditioners

Model(s): Outdoor Unit Indoor Unit
 U-200PZH2E8 S-50PU2E5Bx4

Outdoor side heat exchanger of air conditioner:
 Indoor side heat exchanger of air conditioner:
 Type: compressor driven vapour compression or sorption process
 if applicable: driver of compressor: [electric motor or fuel driven, gaseous or liquid fuel, internal or external combustion engine]

air
 air
 vapour compression
 electric motor

Information requirements for heat pumps

Model(s): Outdoor Unit Indoor Unit
 U-200PZH2E8 S-50PU2E5Bx4

Outdoor side heat exchanger of heat pump:
 Indoor side heat exchanger of heat pump:
 Indication if the heater is equipped with a supplementary heater:
 if applicable: driver of compressor: [electric motor or fuel driven, gaseous or liquid fuel, internal or external combustion engine]

air
 air
 no
 electric motor

Parameters shall be declared for the average heating season, parameters for the warmer and colder heating seasons are optional.

Item	Symbol	Value	Unit	Item	Symbol	Value	Unit
Rated cooling capacity	P _{rated,c}	20.0	kW	Seasonal space cooling energy efficiency	η _{p,c}	326.2	%
Refrigeration load	P _{design,c}	20.0	kW	Declared energy efficiency ratio or gas utilization efficiency / auxiliary energy factor for part load at given outdoor temperatures T _J			
Declared cooling capacity for part load at given outdoor temperatures T _J and indoor 27°/19°C (dry/wet bulb)							
T _J = + 35 °C		20.0	kW	T _J = + 35 °C		3.5	%
T _J = + 30 °C		14.7	kW	T _J = + 30 °C	EER _o or GUE _{o,bin} / AEF _{o,bin}	5.6	%
T _J = + 25 °C	P _{dc}	9.5	kW	T _J = + 25 °C		10.3	%
T _J = + 20 °C		6.9	kW	T _J = + 20 °C		19.1	%
Degradation co-efficient for air conditioners**	C _{dc}	0.25	-				
For air-to-water heat pumps: T _J = - 15 °C (if T _{o,c} < - 20 °C)							
Power consumption in modes other than 'active mode'							
Off mode	P _{OFF}	0.020	kW	Crankcase heater mode	P _{CH}	0.010	kW
Thermostat-off mode	P _{TO}	0.020	kW	Standby mode	P _{SB}	0.020	kW
Other items							
Capacity control		variable		For air-to-air air conditioner: air flow rate, outdoor		9840	m³/h
Sound power level, outdoor	L _{WA}	77.0	dB				
Sound power level, indoor	L _{WA}	47.0	dB	if engine driven: Emissions of nitrogen oxides	NO _x ***	-	mg/kWh fuel input GCV
				GWP of the refrigerant		675	kg CO ₂ eq (100 years)
Contact details				Panasonic Testing Centre, Panasonic Marketing Europe GmbH Winsbergiring 15, 22525 Hamburg, Germany			

** If C_{dc} is not determined by measurement then the default degradation coefficient air conditioners shall be 0.25.
 *** from 26 September 2018.
 Where information relates to multi-split air conditioners, the test result and performance data may be obtained on the basis of the performance of the outdoor unit, with a combination of indoor unit(s) recommended by the manufacturer or importer.
 **** Refer to information requirements for UnitList

Item	Symbol	Value	Unit	Item	Symbol	Value	Unit
Rated heating capacity	P _{rated,h}	22.4	kW	Seasonal space heating energy efficiency	η _{p,h}	182.3	%
Refrigeration load	P _{design,h}	18.0	kW	Declared coefficient of performance or gas utilization efficiency / auxiliary energy factor for part load at given outdoor temperatures T _J			
Declared heating capacity for part load at indoor temperature 20 °C and outdoor temperature T _J							
T _J = - 7 °C		15.9	kW	T _J = - 7 °C		2.8	%
T _J = + 2 °C		9.7	kW	T _J = + 2 °C		4.1	%
T _J = + 7 °C		6.3	kW	T _J = + 7 °C		7.4	%
T _J = + 12 °C		6.0	kW	T _J = + 12 °C		9.6	%
T _{hw} = bivalent temperature	P _{th}	18.0	kW	T _{hw} = bivalent temperature	GUE _{o,bin} / AEF _{o,bin}	2.6	%
T _{o,c} = operation limit		12.3	kW	T _{o,c} = operation limit		2.1	%
For water-to-air heat pumps: T _J = - 15 °C (if T _{o,c} < - 20 °C)							
Bivalent temperature	T _{hw}	-10	°C	For water-to-air heat pumps: Operation limit temperature	T _{o,c}	-20	°C
Degradation co-efficient heat pumps**	C _{dh}	0.25	-				
Power consumption in modes other than 'active mode'							
Off mode	P _{OFF}	0.020	kW	Supplementary heater back-up heating capacity *	elbu	0.0	kW
Thermostat-off mode	P _{TO}	0.020	kW	Type of energy input			
Crankcase heater mode	P _{CH}	0.010	kW	Standby mode	P _{SB}	0.020	kW
Other items							
Capacity control		variable		For air-to-air heat pumps: air flow rate, outdoor		9840	m³/h
Sound power level, outdoor	L _{WA}	79.0	dB	For water-/brine-to-air heat pumps: Rated brine or water flow rate, outdoor side heat exchanger		-	m³/h
Sound power level, indoor	L _{WA}	47.0	dB	Emissions of nitrogen oxides (if applicable)	NO _x ***	-	mg/kWh fuel input GCV
				GWP of the refrigerant		675	kg CO ₂ eq (100 years)
Contact details				Panasonic Testing Centre, Panasonic Marketing Europe GmbH Winsbergiring 15, 22525 Hamburg, Germany			

** If C_{dh} is not determined by measurement then the default degradation coefficient of heat pumps shall be 0.25.
 *** from 26 September 2018.
 Where information relates to multi-split heat pumps, the test result and performance data may be obtained on the basis of the performance of the outdoor unit, with a combination of indoor unit(s) recommended by the manufacturer or importer.
 **** Refer to information requirements for UnitList

Information requirements for air-to-air air conditioners

Model(s):	Outdoor Unit Indoor Unit	U-250PZH2E8 S-125PU2E5Bx2
Outdoor side heat exchanger of air conditioner:	air	
Indoor side heat exchanger of air conditioner:	air	
Type: compressor driven vapour compression or sorption process	vapour compression	
if applicable: driver of compressor: [electric motor or fuel driven, gaseous or liquid fuel, internal or external combustion engine]	electric motor	

Information requirements for heat pumps

Model(s):	Outdoor Unit Indoor Unit	U-250PZH2E8 S-125PU2E5Bx2
Outdoor side heat exchanger of heat pump:	air	
Indoor side heat exchanger of heat pump:	air	
Indication if the heater is equipped with a supplementary heater:	no	
if applicable: driver of compressor: [electric motor or fuel driven, gaseous or liquid fuel, internal or external combustion engine]	electric motor	
Parameters shall be declared for the average heating season, parameters for the warmer and colder heating seasons are optional.		

Item	Symbol	Value	Unit	Item	Symbol	Value	Unit
Rated cooling capacity	$P_{rated,c}$	25.0	kW	Seasonal space cooling energy efficiency	$\eta_{p,c}$	296.2	%
Refrigeration load	$P_{design,c}$	25.0	kW	Declared energy efficiency ratio or gas utilization efficiency / auxiliary energy factor for part load at given outdoor temperatures			
Declared cooling capacity for part load at given outdoor temperatures T_{jand} indoor $27^{\circ}C$ (dry/wet bulb) T_j							
$T_j = +35^{\circ}C$		25.0	kW	$T_j = +35^{\circ}C$		3.1	%
$T_j = +30^{\circ}C$		18.4	kW	$T_j = +30^{\circ}C$	EER _o or GUE _{o,bin} / AEF _{o,bin}	4.9	%
$T_j = +25^{\circ}C$	P_{dc}	11.9	kW	$T_j = +25^{\circ}C$		8.6	%
$T_j = +20^{\circ}C$		7.0	kW	$T_j = +20^{\circ}C$		20.8	%
Degradation co-efficient for air conditioners**	C_{dc}	0.25	-				
Power consumption in modes other than 'active mode'							
Off mode	P_{OFF}	0.020	kW	Crankcase heater mode	P_{CH}	0.010	kW
Thermostat-off mode	P_{TO}	0.020	kW	Standby mode	P_{SB}	0.020	kW
Other items							
Capacity control		variable		For air-to-air air conditioner: air flow rate, outdoor		9600	m ³ /h
Sound power level, outdoor	L_{WA}	78.0	dB				
Sound power level, indoor	L_{WA}	61.0	dB	if engine driven: Emissions of nitrogen oxides	NO_x^{***}	-	mg/kWh fuel input GCV
				GWP of the refrigerant		675	kg CO ₂ eq (100 years)
Contact details	Panasonic Testing Centre, Germany			Panasonic Marketing Europe GmbH Winsbergiring 15, 22525 Hamburg, Germany			

Item	Symbol	Value	Unit	Item	Symbol	Value	Unit
Rated heating capacity	$P_{rated,h}$	28.0	kW	Seasonal space heating energy efficiency	$\eta_{p,h}$	174.1	%
Refrigeration load	$P_{design,h}$	20.0	kW	Declared coefficient of performance or gas utilization efficiency / auxiliary energy factor for part load at given outdoor temperatures			
Declared heating capacity for part load at indoor temperature 20 °C and outdoor temperature T_j							
$T_j = -7^{\circ}C$		17.6	kW	$T_j = -7^{\circ}C$		2.7	%
$T_j = +2^{\circ}C$		10.9	kW	$T_j = +2^{\circ}C$		3.9	%
$T_j = +7^{\circ}C$		7.0	kW	$T_j = +7^{\circ}C$		7.1	%
$T_j = +12^{\circ}C$		6.1	kW	$T_j = +12^{\circ}C$		9.4	%
T_{bw} = bivalent temperature	P_{bh}	20.0	kW	T_{bw} = bivalent temperature	GUE _{o,bin} / AEF _{o,bin}	2.2	%
T_{co} = operation limit		14.5	kW	T_{co} = operation limit		1.9	%
For air-to-water heat pumps: $T_j = -15^{\circ}C$ (if $T_{co} < -20^{\circ}C$)		-	kW	For water-to-air heat pumps: $T_j = -15^{\circ}C$ (if $T_{co} < -20^{\circ}C$)		-	%
Bivalent temperature	T_{bw}	-10	°C	For water-to-air heat pumps: Operation limit temperature	T_{co}	-20	°C
Degradation co-efficient heat pumps**	C_{dh}	0.25	-				
Power consumption in modes other than 'active mode'							
Off mode	P_{OFF}	0.020	kW	Supplementary heater back-up heating capacity *	elbu	0.0	kW
Thermostat-off mode	P_{TO}	0.020	kW	Type of energy input			
Crankcase heater mode	P_{CH}	0.010	kW	Standby mode	P_{SB}	0.020	kW
Other items							
Capacity control		variable		For air-to-air heat pumps: air flow rate, outdoor		9600	m ³ /h
Sound power level, outdoor	L_{WA}	82.0	dB	For water-/brine-to-air heat pumps: Rated brine or water flow rate, outdoor side heat exchanger		-	m ³ /h
Sound power level, indoor	L_{WA}	61.0	dB	Emissions of nitrogen oxides (if applicable)	NO_x^{***}	-	mg/kWh fuel input GCV
				GWP of the refrigerant		675	kg CO ₂ eq (100 years)
Contact details	Panasonic Testing Centre, Germany			Panasonic Marketing Europe GmbH Winsbergiring 15, 22525 Hamburg, Germany			

** If C_{dc} is not determined by measurement then the default degradation coefficient of air conditioners shall be 0.25.
 *** from 26 September 2018.
 Where information relates to multi-split air conditioners, the test result and performance data may be obtained on the basis of the performance of the outdoor unit, with a combination of indoor unit(s) recommended by the manufacturer or importer.
 **** Refer to information requirements for UnitList

Information requirements for air-to-air air conditioners

Model(s): Outdoor Unit U-250PZH2E8
Indoor Unit S-60PU2E5Bx4

Outdoor side heat exchanger of air conditioner: air
Indoor side heat exchanger of air conditioner: air
Type: compressor driven vapour compression or sorption process vapour compression
if applicable: driver of compressor: electric motor or fuel driven, gaseous or liquid fuel, internal or external combustion engine] electric motor

Item	Symbol	Value	Unit	Item	Symbol	Value	Unit
Rated cooling capacity	P _{rated,c}	25.0	kW	Seasonal space cooling energy efficiency	η _{p,c}	296.2	%
Refrigeration load	P _{design,r,c}	25.0	kW	Declared energy efficiency ratio or gas utilization efficiency / auxiliary energy factor for part load at given outdoor temperatures T _J			
Declared cooling capacity for part load at given outdoor temperatures T _J and indoor 27°/19°C (dry/wet bulb)							
T _J = + 35 °C		25.0	kW	T _J = + 35 °C		3.1	%
T _J = + 30 °C		18.4	kW	T _J = + 30 °C	EER _o or GUE _{o,bln} / AEF _{o,bln}	4.9	%
T _J = + 25 °C	P _{dc}	11.9	kW	T _J = + 25 °C		8.6	%
T _J = + 20 °C		7.0	kW	T _J = + 20 °C		20.8	%
Degradation co-efficient for air conditioners**	C _{dc}	0.25	-				
Power consumption in modes other than 'active mode'							
Off mode	P _{OFF}	0.020	kW	Crankcase heater mode	P _{CH}	0.010	kW
Thermostat-off mode	P _{TO}	0.020	kW	Standby mode	P _{SB}	0.020	kW
Other items							
Capacity control		variable		For air-to-air air conditioner: air flow rate, outdoor		9600	m³/h
Sound power level, outdoor	L _{WA}	78.0	dB				
Sound power level, indoor	L _{WA}	51.0	dB	if engine driven: Emissions of nitrogen oxides	NO _x ***	-	mg/kWh fuel input GCV
				GWP of the refrigerant		675	kg CO ₂ eq (100 years)
Contact details	Panasonic Testing Centre, Germany			Panasonic Marketing Europe GmbH Winsbergiring 15, 22525 Hamburg, Germany			

** If C_{dc} is not determined by measurement then the default degradation coefficient air conditioners shall be 0.25.
*** from 26 September 2018.
Where information relates to multi-split air conditioners, the test result and performance data may be obtained on the basis of the performance of the outdoor unit, with a combination of indoor unit(s) recommended by the manufacturer or importer.
**** Refer to information requirements for UnitList

Information requirements for heat pumps

Model(s): Outdoor Unit U-250PZH2E8
Indoor Unit S-60PU2E5Bx4

Outdoor side heat exchanger of heat pump: air
Indoor side heat exchanger of heat pump: air
Indication if the heater is equipped with a supplementary heater: no
if applicable: driver of compressor: electric motor or fuel driven, gaseous or liquid fuel, internal or external combustion engine] electric motor

Parameters shall be declared for the average heating season, parameters for the warmer and colder heating seasons are optional.

Item	Symbol	Value	Unit	Item	Symbol	Value	Unit
Rated heating capacity	P _{rated,h}	28.0	kW	Seasonal space heating energy efficiency	η _{p,h}	174.1	%
Refrigeration load	P _{design,r,h}	20.0	kW	Declared coefficient of performance or gas utilization efficiency / auxiliary energy factor for part load at given outdoor temperatures T _J			
Declared heating capacity for part load at indoor temperature 20 °C and outdoor temperature T _J							
T _J = - 7 °C		17.6	kW	T _J = - 7 °C		2.7	%
T _J = + 2 °C		10.9	kW	T _J = + 2 °C		3.9	%
T _J = + 7 °C		7.0	kW	T _J = + 7 °C		7.1	%
T _J = + 12 °C		6.1	kW	T _J = + 12 °C		9.4	%
T _{bw} = bivalent temperature	P _{bh}	20.0	kW	T _{bw} = bivalent temperature	GUE _{o,bln} / AEF _{o,bln}	2.2	%
T _{co} = operation limit		14.5	kW	T _{co} = operation limit		1.9	%
For air-to-water heat pumps: T _J = - 15 °C (if T _{co} < - 20 °C)		-	kW	For water-to-air heat pumps: T _J = - 15 °C (if T _{co} < - 20 °C)		-	%
Bivalent temperature	T _{bw}	-10	°C	For water-to-air heat pumps: Operation limit temperature	T _{co}	-20	°C
Degradation co-efficient heat pumps**	C _{dh}	0.25	-				
Power consumption in modes other than 'active mode'							
Off mode	P _{OFF}	0.020	kW	Supplementary heater back-up heating capacity *	elbu	0.0	kW
Thermostat-off mode	P _{TO}	0.020	kW	Type of energy input			
Crankcase heater mode	P _{CH}	0.010	kW	Standby mode	P _{SB}	0.020	kW
Other items							
Capacity control		variable		For air-to-air heat pumps: air flow rate, outdoor		9600	m³/h
Sound power level, outdoor	L _{WA}	82.0	dB	For water-/brine-to-air heat pumps: Rated brine or water flow rate, outdoor side heat exchanger		-	m³/h
Sound power level, indoor	L _{WA}	51.0	dB	Emissions of nitrogen oxides (if applicable)	NO _x ***	-	mg/kWh fuel input GCV
				GWP of the refrigerant		675	kg CO ₂ eq (100 years)
Contact details	Panasonic Testing Centre, Germany			Panasonic Marketing Europe GmbH Winsbergiring 15, 22525 Hamburg, Germany			

** If C_{dh} is not determined by measurement then the default degradation coefficient of heat pumps shall be 0.25.
*** from 26 September 2018.
Where information relates to multi-split heat pumps, the test result and performance data may be obtained on the basis of the performance of the outdoor unit, with a combination of indoor unit(s) recommended by the manufacturer or importer.
**** Refer to information requirements for UnitList

– MEMO –

2. TEST RUN

2-1. Preparing for Test Run	2-2
2-2. Precautions	2-3
■ Indoor Units	
2-3. Caution	2-4
2-4. Test Run Procedure	2-4
2-5. Items to Check Before the Test Run	2-5
2-6. Test Run Using the Remote Controller	2-5
2-7. Contents of Remote Controller Switch Alarm Display	2-6
2-8. System Control	2-8
■ Outdoor Units	
2-9. Test Run Procedure	2-14
2-10. CHECKS AFTER INSTALLATION HAVE COMPLETED	2-14
2-11. REGARDING DELIVERY TO THE CUSTOMER	2-14
2-12. Caution for Pump Down	2-15

2-1. Preparing for Test Run

• Before attempting to start the air conditioner, check the following:

- (1) All loose matter is removed from the cabinet especially steel filings, bits of wire, and clips.
- (2) The control wiring is correctly connected and all electrical connections are tight.
- (3) The protective spacers for the compressor used for transportation have been removed. If not, remove them now.
- (4) The transportation pads for the indoor fan have been removed. If not, remove them now.
- (5) The power has been supplied to the unit for at least 12 hours before starting the compressor. The bottom of the compressor should be warm to the touch and the crankcase heater around the feet of the compressor should be hot to the touch. (Fig. 2-1)
- (6) Both the gas and liquid tube service valves are open. If not, open them now. (Fig. 2-2)
- (7) Request that the customer be present for the test run. Explain the contents of the instruction manual, and then have the customer actually operate the system.
- (8) Be sure to give the instruction manual and warranty certificate to the customer.
- (9) When replacing the control PCB, be sure to make all the same settings on the new PCB as were in use before replacement. The existing EEPROM is not changed, and is connected to the new control PCB.

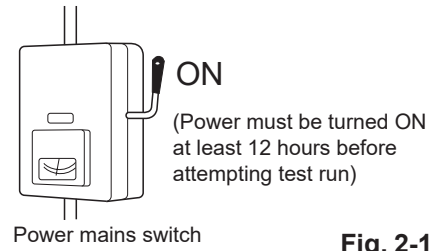


Fig. 2-1

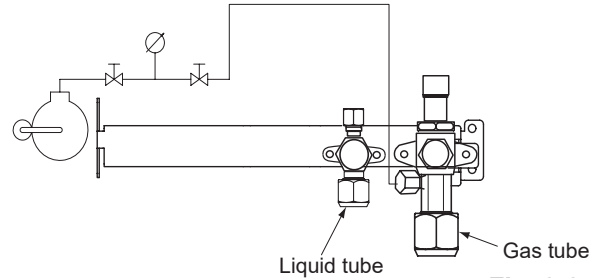


Fig. 2-2

Check Before Test Run

	Content check
Power supply cable Indoor/outdoor connection wire Earth wire	<ul style="list-style-type: none"> ● Is the wire set up and connected as described in the instructions? Check for any phase sequence. ● Are the wire connection's screws loose? ● Is the open and close device / leakage breaker installed? ● Is the power supply cable's thickness and length appropriately measured as described in the instructions? ● Is it earthed (grounded)? ● Check that the insulation resistant value is more than 1MΩ. Use the 500 V mega-testers to measure the insulation. Do not use the mega-tester for any other circuit except for voltage of 220-230-240V~ or 380-400-415V 3N~. ● Are the wire connections for the indoor/outdoor units connected as described in the instructions? Are there any looped wires? ● Was the "N-phase" surely connected when connecting the power supply wire on the three-phase model? If N-phase is not connected, only the fan may repeat turning ON/OFF without the compressor operating. In that case, check if there is any problem with N-phase connection.
Refrigerant tube	<ul style="list-style-type: none"> ● Is the tubing installed as described in the instructions? ● Are the tubes sizes appropriate? ● Does the tube's length adhere to the specifications? ● Is the branch tube slant being appropriately done as described in the instructions? ● Was vacuum removal sufficiently carried out? ● Was the leak tightness test carried out with nitrogen gas? Use the testing pressure of 4.15 MPa. ● Is the tubing insulation material appropriately installed? (Insulation material is necessary for both gas and liquid tubing.) ● Is the 3-way valve for the liquid tube and gas tube open?

- Always be sure to use a properly insulated tool to operate the short-circuit pin on the circuit board. (Do not use your finger.)
- Never switch the power supply ON until the installation has completed.
- Supply electrical current through all indoor units and check the voltage.
- Supply electrical current through all the outdoor units and check each inter-phase voltage.
- Before the test run, ensure to check that the 3-way valve is open. Operating while the valve is closed causes the compressor to fail.

2-2. Precautions

- Request that the customer be present when the test run is performed.
At this time, explain the operation manual and have the customer perform the actual steps.

OUTDOOR UNIT MAIN PCB (CR)

- Be sure to pass the manuals and warranty certificate to the customer.
- Check that the 220 – 240 VAC power is not connected to the inter-unit control wiring connector terminal.
- * If 220 – 240 VAC is accidentally applied, the indoor or outdoor unit control PCB fuse will blow in order to protect the PCB.

Correct the wiring connections, then disconnect the 2P connectors that are connected to the PCB, and replace them with 2P connectors.
If operation is still not possible after changing the brown connectors, try cutting the varistor.
(Be sure to turn the power OFF before performing this work.)

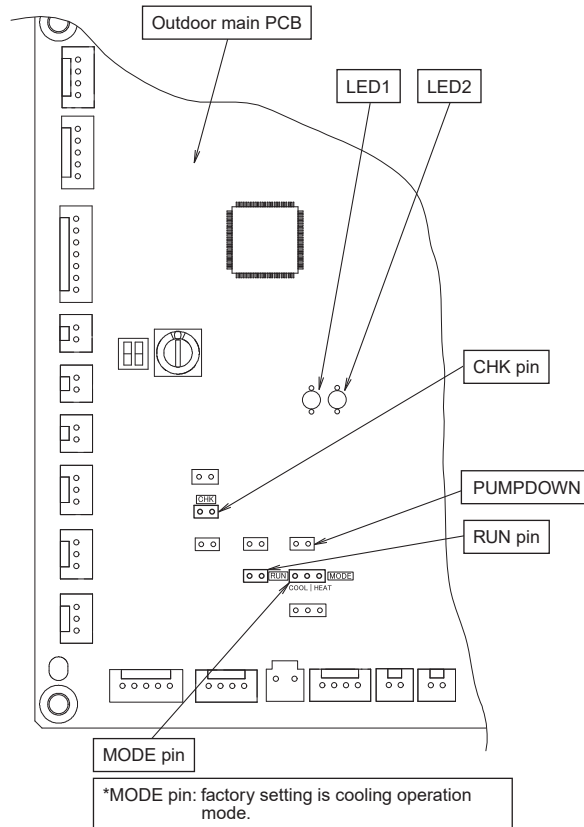


Fig. 2-3

INDOOR UNIT MAIN PCB (CR)

- Check that the 220 –240 VAC power is not connected to the inter-unit control wiring connector terminal.
- * If 220 –240 VAC is accidentally applied, the indoor unit control PCB fuse will blow in order to protect the PCB. In this case, make the wiring correctly. Then disconnect the 2P connectors (OC) that are connected to the indoor unit PCB, and replace them with 2P connectors (EMG).
- If operation is still not possible after changing the brown connectors, cut the jumper on the indoor unit PCB.
(Be sure to turn the power OFF before performing this work.)

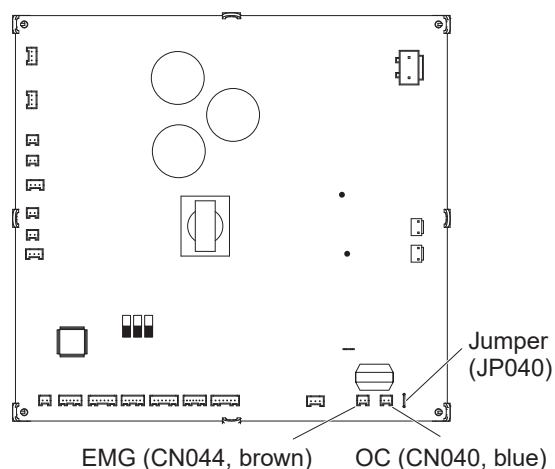


Fig. 2-4

■ Indoor Units

2-3. Caution

- The indoor and outdoor unit control PCB utilizes a semiconductor memory element (EEPROM). The settings required for operation were made at the time of shipment. Only the correct combinations of indoor and outdoor units can be used.
- This test run section describes primarily the procedure when using the wired remote controller.

2-4. Test Run Procedure

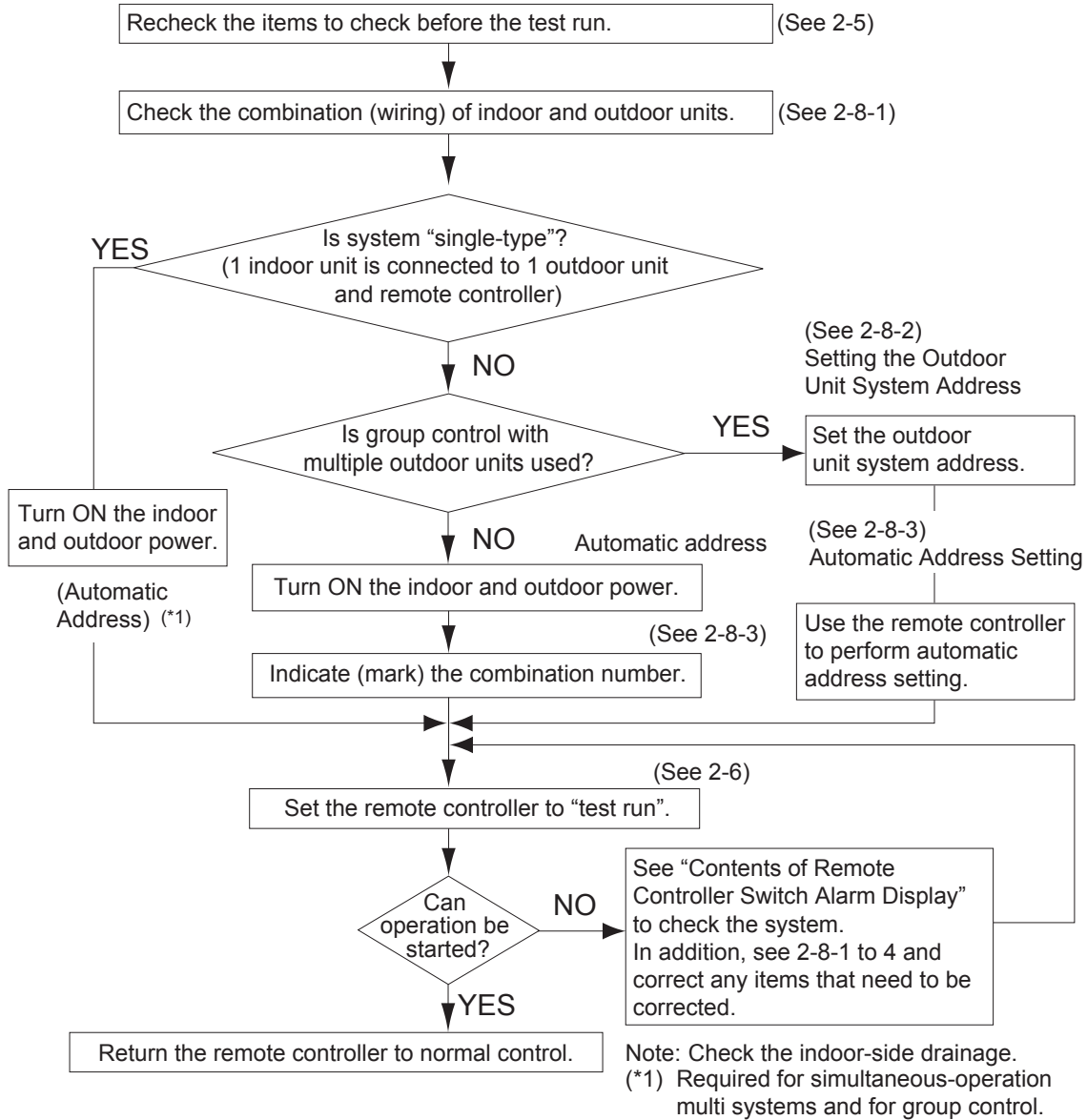





Fig. 2-5

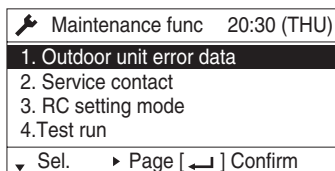
2-5. Items to Check Before the Test Run

- (1) Turn the remote power switch ON at least 12 hours in advance in order to energize the crankcase heater.
- (2) Fully open the closed valves on the liquid-tube and gas-tube sides.



2-6. Test Run Using the Remote Controller


CZ-RTC5B (High-spec wired remote controller)

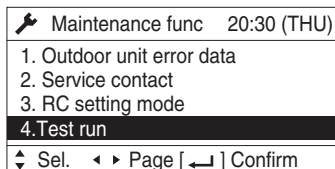
- (1) Keep pressing the , , and  buttons simultaneously for 4 or more seconds.
The "Maintenance func" screen appears on the LCD display.






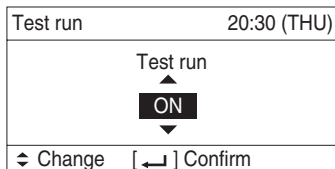
- (2) Press the  or  button to see each menu.

If you wish to see the next screen instantly, press the  or  button.


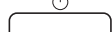
Select "4. Test run" on the LCD display and press the  button.



Change the display from OFF to ON by pressing the  or  button. Then press the  button.



CZ-RTC4 (Timer remote controller)


- (1) Press the remote controller  button for 4 seconds or longer.
Then press the  button.

- "TEST" appears on the LCD display while the test run is in progress.
- The temperature cannot be adjusted when in Test Run mode.
(This mode places a heavy load on the machines. Therefore use it only when performing the test run.)

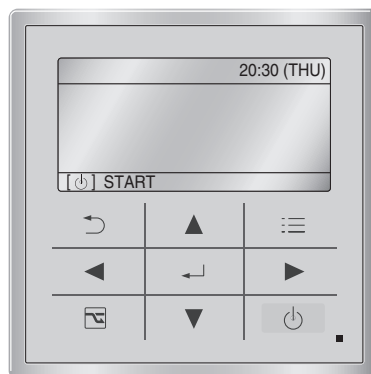
- (2) The test run can be performed using the HEAT, COOL, or FAN operation modes.

NOTE


The outdoor units will not operate for approximately 3 minutes after the power is turned ON and after operation is stopped.

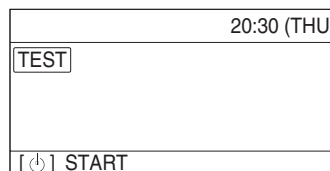
- (3) If correct operation is not possible, a code is displayed on the remote controller LCD display.
(See the section "7. Self-Diagnostic Function Table and Contents of Alarm Display" and correct the problem.)
- (4) After the test run is completed, press the  button again.
Check that "TEST" disappears from the LCD display.
(To prevent continuous test runs, this remote controller includes a timer function that cancels the test run after 60 minutes.)


* If the test run is performed using the wired remote controller, operation is possible even if the cassette-type ceiling panel has not been installed. ("P09" display does not occur.)

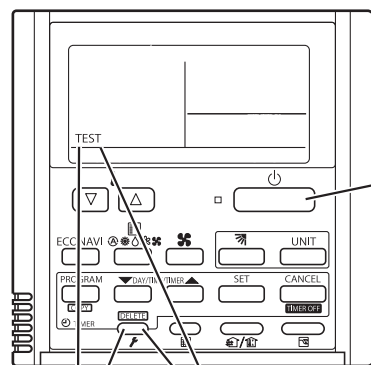
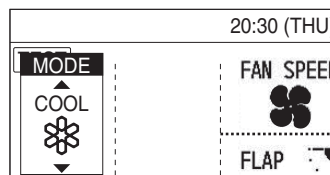


CZ-RTC5B

- (3) Press the  button. "TEST" will be displayed on the LCD display.



- (4) Press the  button. Test run will be started.
Test run setting mode screen appears on the LCD display.



CZ-RTC4

2-7. Contents of Remote Controller Switch Alarm Display

ON: ○ Blinking: ☀ OFF: ●

Possible cause of malfunction		Wired remote control display	Wireless remote controller receiver display		
			Operation	Timer	Standby
Serial communication errors Missetting	Failure in receiving serial signal from remote controller's indoor unit	Faulty remote controller Disconnection/Contact failure of remote controller wiring CHK(check) pins on the indoor unit control PCB are short circuited			
	Settings of system address, indoor unit address and group control are not made	In the case of non-group control: • Power supply OFF of outdoor unit • Disconnection / Contact failure of inter-unit wiring In the case of group control: Automatic address operation was not carried out.	E01	Operating lamp blinking ☀ ● ●	
	Setting failure of nonvolatile memory IC	Faulty setting of EEPROM on indoor unit			
	Failure in indoor unit serial signal from remote controller	Faulty remote controller Wrong wiring of remote controller	E02		
	Error in indoor unit receiving signal from remote controller (central)		E03		
	Failure in indoor unit receiving serial signal from outdoor unit	Disconnection / Contact failure of inter-unit wiring • Faulty indoor unit control PCB • Faulty outdoor unit control PCB • Communication circuit fuse on indoor unit control PCB opened	E04	Standby lamp blinking ● ● ☀	
		• Fuse on outdoor unit control PCB opened Since failure of an outdoor fan motor is considered as a cause, both outdoor unit control PCB and outdoor unit fan motor are exchanged simultaneously.			
	Failure in outdoor unit receiving serial signal from indoor unit	• Disconnection / Contact failure of inter-unit wiring • Disconnection of inter-unit wiring • Communication circuit fuse on indoor unit control PCB opened	E06	● ● ☀	
		Indoor unit control PCB address setting error			
	Duplication of indoor unit address	Duplication of indoor unit address setting	E08		
	Duplication of main remote controller setting	Error because of more than one remote controller setting to main	E09		
	Improper setting	Automatic address setting start is prohibited	E12	Operating lamp blinking ☀ ● ●	
		Duplication of main unit in group control	E14	☀ ● ●	
	Communication error between main and sub indoor units	• Disconnection of wiring between main unit and additional units • Contact failure of wiring • Faulty indoor unit control PCB (Main or Addition)	E18	☀ ● ●	
	Automatic address settings failure	Automatic Address Alarm The total capacity of indoor units is too low	E15		
		Automatic Address Alarm The total capacity of indoor units is too high	E16	Standby lamp blinking ● ● ☀	
		Automatic Address Alarm No indoor unit connected	E20	● ● ☀	
	Outdoor unit Communication error		E24		
	Outdoor unit Communication error		E29		
	Indoor & outdoor unit type miss-matched	Setting error, indoor/outdoor unit type/model miss-matched	L02		
Duplication of group control's main indoor unit	Duplication of main indoor unit address in group control	L03	Operating and standby lamps blinking simultaneously ☀ ● ☀		
Group control wiring is connected to individual control indoor unit	Group control wiring is connected to individual control indoor unit	L07	☀ ● ☀		
Indoor unit address is not set		L08	☀ ● ☀		
Indoor unit capacity is not set		L09			
Duplication of outdoor unit address		L04			
Outdoor unit capacity is not set or setting error		L10	Operating and standby lamps blinking simultaneously ☀ ● ☀		
Indoor unit type setting error Type of indoor/outdoor units is different		L13	☀ ○ ☀		
4-way valve locked trouble / operation failure		L18	☀ ○ ☀		

Continued

ON: ○ Blinking: ☀ OFF: ●

Possible cause of malfunction		Wired remote control display	Wireless remote controller receiver display				
			Operation	Timer	Standby		
Activation of protective device	Faulty wiring connections of (ceiling) indoor unit panel	P09	☀	○	○		
	Indoor unit fan motor trouble	Indoor unit fan motor locked	P01	○	○	○	
		Indoor unit fan motor layer short		○	○	○	
		Contact failure in thermostat protector circuit		○	○	○	
	Activation of float switch wiring	Faulty drain pump	P10	○	○	○	
		Drainage failure		○	○	○	
		Contact failure of float switch wiring		○	○	○	
	Faulty drain pump	Faulty drain pump	P11	○	○	○	
		Drain pump locked		○	○	○	
	WHE water freezing alarm	WHE water freezing error		●	☀	☀	
	Indoor unit fan motor trouble	Indoor unit fan motor locked	P12	○	○	○	
		Faulty wiring connections of indoor unit fan motor		○	○	○	
	Valve error	Valve error	P13	○	○	○	
		Refrigerant circuit error		○	○	○	
		Wrong installation for refrigerant piping and wiring		○	○	○	
	O ₂ sensor error	O ₂ sensor detected	P14	○	○	○	
	Activation of protective device	Discharge temperature protective alarm	Compressor discharge temperature trouble	P03	○	○	○
		Activation of high pressure switch	Compressor discharge pressure trouble	P04	○	○	○
		Power supply failure	Open phase detected	P05	○	○	○
			AC power supply trouble		○	○	○
Insufficient gas		Insufficient gas level detected	P15	○	○	○	
Compressor overcurrent trouble			P16	☀	●	☀	
Fan motor locked/reversed airflow detected		Outdoor unit fan motor trouble	P22	○	○	○	
		Outdoor unit fan trouble		○	○	○	
WHE water pump interlock OFF alarm		WHE pump interlock error	P23	○	○	○	
Inverter compressor trouble			P29	○	○	○	
Group control trouble	Indoor unit in group control trouble	P31	○	○	○		
Activation of current control compressor's protective device	Primary (input) overcurrent detected	H01	○	○	○		
PAM trouble (overcurrent/over-voltage), Activation of compressor's protective device	PAM trouble	H02	○	○	○		
	Primary current control, Activation of compressor's protective device	Primary current CT sensor failure	H03	○	○	○	
	HIC trouble	HIC trouble DC voltage not detected	H31	○	○	○	
Thermistor fault	Indoor unit thermistor open/short	Indoor heat exchanger temperature sensor (E1) trouble	F01	○	○	○	
		Indoor heat exchanger temperature sensor (E2) trouble	F02	○	○	○	
		Indoor air temperature sensor (TA) trouble	F10	☀	☀	●	
	Outdoor unit thermistor open/short	Compressor discharge temperature sensor (TD) trouble	F04	○	○	○	
		Outdoor heat exchanger temperature sensor (C1) trouble	F06	○	○	○	
		Outdoor heat exchanger temperature sensor (C2) trouble	F07	○	○	○	
		Outdoor air temperature sensor (TO) trouble	F08	☀	☀	○	
Compressor suction temperature sensor (TS) trouble	F12	○	○	○			
Nonvolatile memory failure	Indoor unit EEPROM trouble	F29	☀	☀	●		
	Outdoor unit EEPROM trouble	F31	☀	☀	○		

2-8. System Control

System control refers to the link wiring connection for control of simultaneous-operation multi systems, group control, and main-sub remote controller control.

2-8-1. Basic wiring diagram

- Be careful to avoid miswiring when connecting the wires. (Miswiring will damage the units.)

(for 3-phase Outdoor unit)

Type E3 (Example of SINGLE type)

Type U2 (Example of TWIN type)

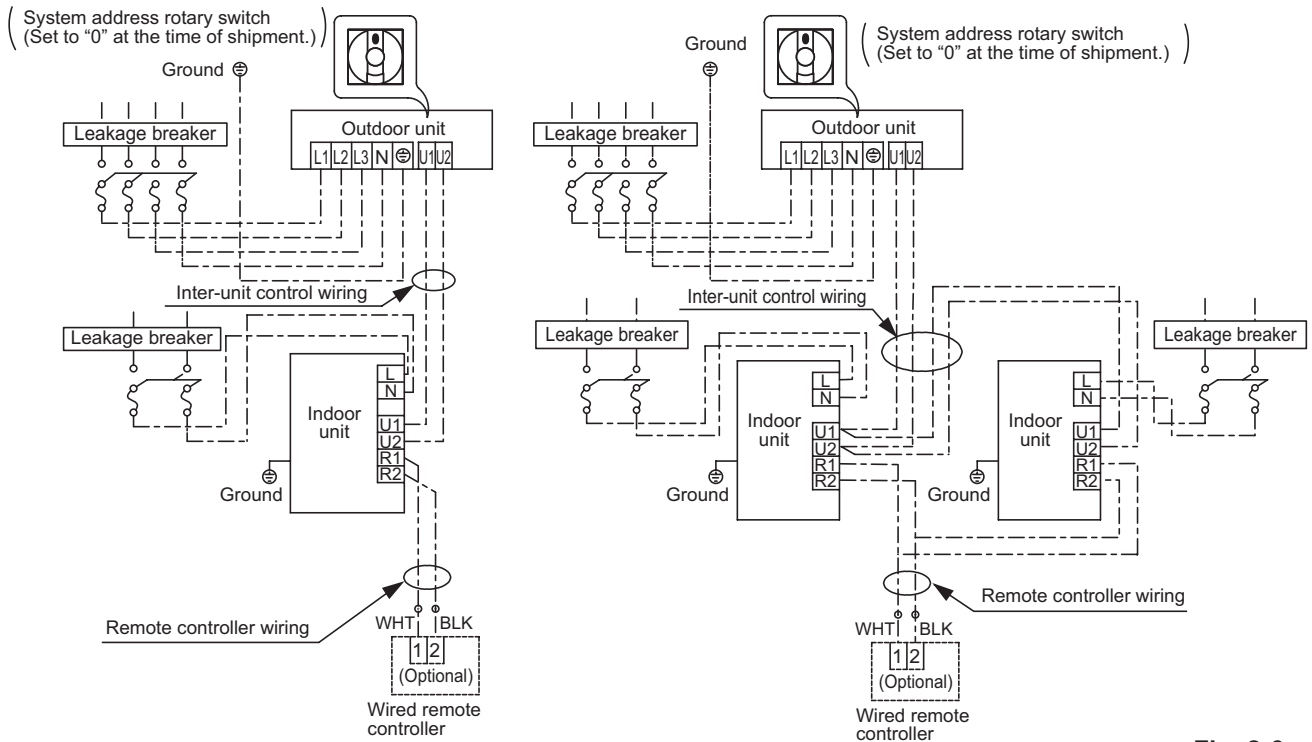


Fig. 2-6

(Wiring procedure)

- (1) Connect the remote controller to the indoor unit remote controller wiring terminal plate (R1, R2). (Remote controller wiring)
- (2) Connect the indoor units (U1, U2) and the outdoor units (U1, U2). Connect the other outdoor units and indoor units (with different refrigerant systems) in the same way. (Inter-unit control wiring)
Connect the remote controller communication wiring to the indoor units (R1, R2) for each refrigerant system. (Remote controller wiring)
- (3) Connect the remote controller communication wiring (2 wires) from the remote controller wiring terminal plate (R1, R2) on the indoor unit (unit where the remote controller is connected) to the remote controller terminal plates (R1, R2) on the other indoor units. (Remote controller communication wiring)
- (4) Turn ON both the indoor and outdoor unit power and perform automatic address setting from the remote controller. (For the automatic address setting procedure, see 2-8-3.)

NOTE

- * Be sure to use the indoor unit temperature sensor (body sensor) when using this control. (Status at shipment.)

2-8-2. Setting the Outdoor unit system addresses

For basic wiring diagram (Set the system address: 1)

Outdoor unit control PCB

System address rotary switch
(Set to "0" at time of shipment)

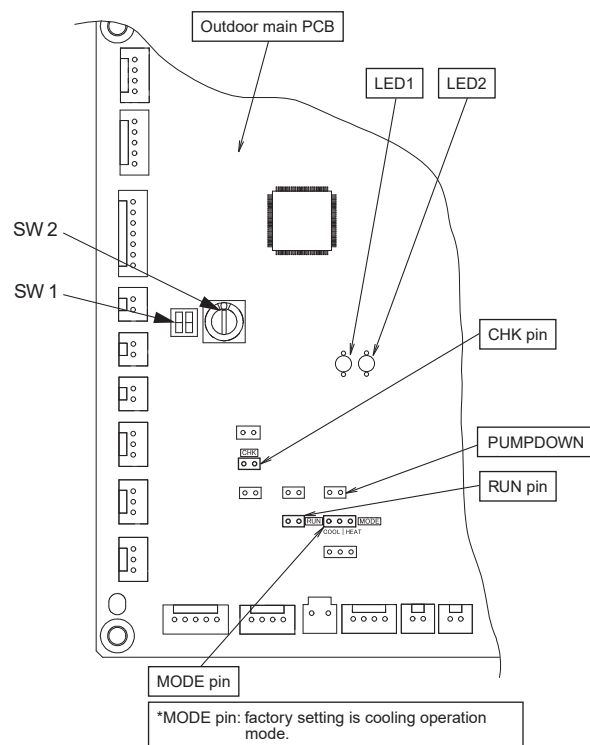
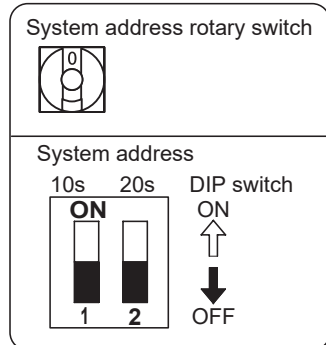


Fig. 2-7

System address No.	System address 10s digit (2P DIP switch)	System address 1s place (Rotary switch)
0 Automatic address (Setting at shipment = "0")	Both OFF 	"0" setting
1 (If outdoor unit is No. 1)	Both OFF 	"1" setting

2-8-3. Automatic address setting using the remote controller

Auto Address Setting from the High-spec Wired Remote Controller (CZ-RTC5B)

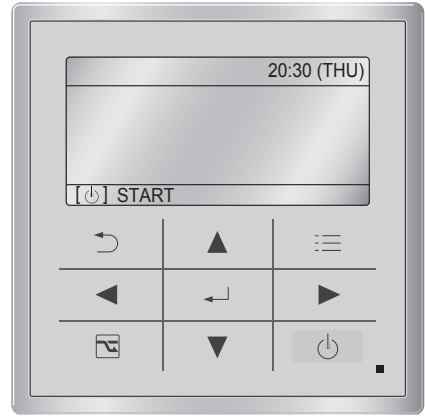
- Keep pressing the , and buttons simultaneously for 4 or more seconds.
The "Maintenance func" screen appears on the LCD display.
- Press the or button to see each menu.
If you wish to see the next screen instantly, press the or button.
Select "9. Auto address" on the LCD display and press the button.

Maintenance func	20:30 (THU)
9. Auto address	
10. Set elec. consumption	
11. Set touch key	
12. Check touch key	
Sel. Page Confirm	

- The "Auto address" screen appears on the LCD display.
Change the "Code no." to "A1" by pressing the or button.

Auto address	20:30 (THU)
Code no.	O/D unit no.
A1	1
Sel. Next	

- Select the "O/D unit no." by pressing the or button.
Select one of the "O/D unit no." for auto address by pressing the or button.
Approximately about 10 minutes are required.
When auto address setting is completed, the units return to normal stopped status.



CZ-RTC5B

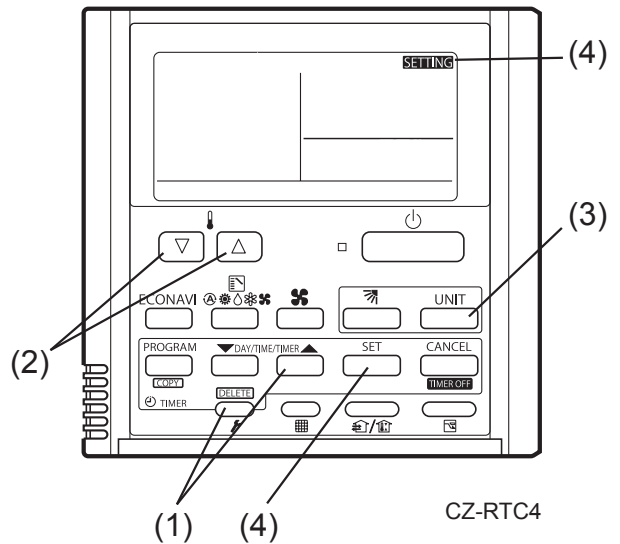
Auto Address Setting* from the Remote Controller (CZ-RTC4)

* Auto address setting in Cooling mode cannot be done from the remote controller.

NOTE

- Selecting each refrigerant system individually for auto address setting
- Auto address setting for each system
: Item code "A1"

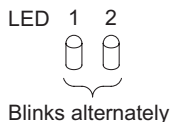
- Press the remote controller timer time button and button at the same time.
(Press and hold for 4 seconds or longer.)
- Next, press either the temperature setting / button. (Check that the item code is "A1".)
- Use either the button to set the system No. to perform auto address setting.
- Then press the button.
(Auto address setting for one refrigerant system begins.) (When auto address setting for one system is completed, the system returns to normal stopped status.)
<Approximately 4 – 5 minutes is required.>
(During auto address setting, "SETTING" is displayed on the remote controller.
This message disappears when auto address setting is completed.)
- Repeat the same steps to perform auto address setting for each successive system.



CZ-RTC4

Display During Auto Address Setting

- On the surface of outdoor unit control P.C. board



- * Do not short circuit the A.ADD pin again during auto address setting. LEDs 1 and 2 go out and address setting is interrupted.
- * When auto address setting is normally completed, both LEDs 1 and 2 go out. In other cases, correct settings referring to the following table and perform auto address setting again.

- Contents of LEDs 1 and 2 on outdoor unit control P.C. board

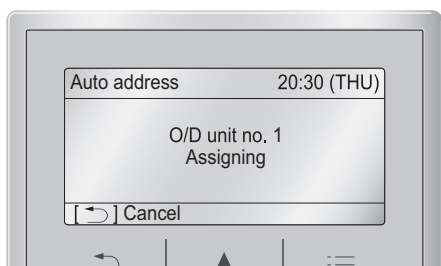
- ☀ : Illuminating
- ★ : Blinking
- : Go out

LED 1	LED 2	Contents of display															
☀	☀	After turned ON power (not during auto address setting), it is entirely impossible to communicate with the indoor unit in the system.															
●	☀	After turned ON power (not during auto address setting), although the indoor units more than 1 unit in the system are recognized, there are inconsistencies between the number of indoor units and setting number of indoor units.															
★	★	Under auto address setting															
Alternately																	
●	●		Auto address setting completed														
★	★	There are inconsistencies between the number of indoor units and setting number of indoor units. (at the time of auto address setting)															
Simultaneously																	
★	★	Alarm display After LED1 blinks M times, LED2 blinks N times. This will be repeated.															
Alternating																	
			<table border="1"> <thead> <tr> <th></th> <th>Number of blinks</th> <th>Type of alarm</th> </tr> </thead> <tbody> <tr> <td rowspan="5">M</td> <td>2</td> <td>Alarm P</td> </tr> <tr> <td>3</td> <td>Alarm H</td> </tr> <tr> <td>4</td> <td>Alarm E</td> </tr> <tr> <td>5</td> <td>Alarm F</td> </tr> <tr> <td>6</td> <td>Alarm L</td> </tr> </tbody> </table>		Number of blinks	Type of alarm	M	2	Alarm P	3	Alarm H	4	Alarm E	5	Alarm F	6	Alarm L
	Number of blinks		Type of alarm														
M	2		Alarm P														
	3	Alarm H															
	4	Alarm E															
	5	Alarm F															
	6	Alarm L															
		N = number of alarm No.															
		For example: After LED1 blinks twice, LED2 blinks 16 times. This will be repeated. The alarm shows "P16".															

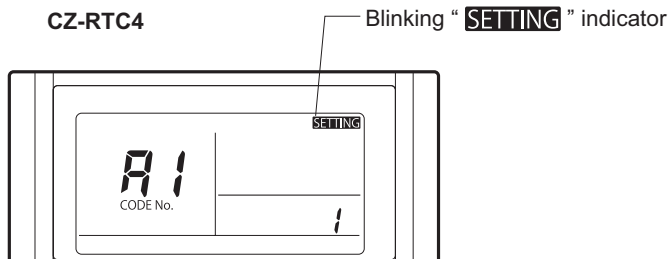
(★ : Blink) Connect the outdoor unit maintenance remote controller to the RC plug (3P, BLU) on outdoor main unit control P.C. board and make confirmation.

- Display of remote controller

CZ-RTC5B



CZ-RTC4



Request concerning recording the indoor/outdoor unit combination numbers.

After auto address setting has been completed, be sure to record them for future reference.

List the outdoor main unit system address and the addresses of the indoor units in that system in an easily visible location (next to the nameplate), using a permanent marking pen or similar means that cannot be abraded easily.

Example: (Outdoor) 1 - (Indoor) 1-1, 1-2, 1-3... (Outdoor) 2 - (Indoor) 2-1, 2-2, 2-3...

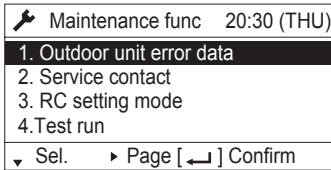
These numbers are necessary for later maintenance. Please be sure to indicate them.

Checking the indoor unit addresses

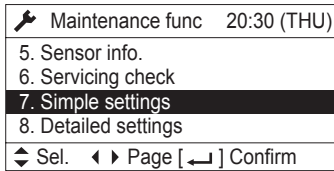
Use the remote controller to check the indoor unit address.

CZ-RTC5B (High-spec wired remote controller)

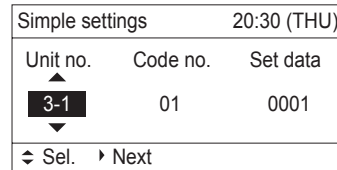
- (1) Keep pressing the , and buttons simultaneously for 4 or more seconds.
The "Maintenance func" screen appears on the LCD display.



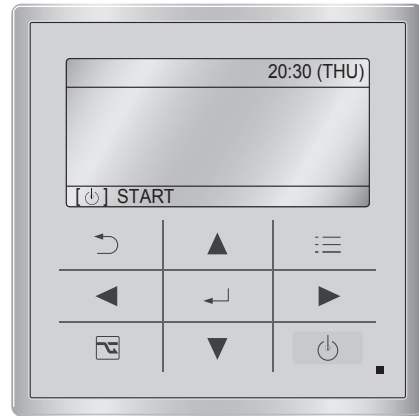
- (2) Press the or button to see each menu.
If you wish to see the next screen instantly, press the or button.
Select "7. Simple settings" on the LCD display and press the button.



- (3) The "Simple settings" screen appears on the LCD display.
Select the "Unit no." by pressing the or button for changes.



The indoor unit fan operates only at the selected indoor unit.

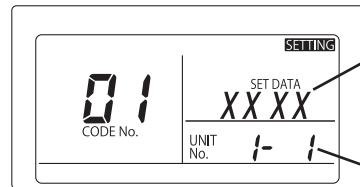


CZ-RTC5B

CZ-RTC4 (Timer remote controller)

<If 1 indoor unit is connected to 1 remote controller>

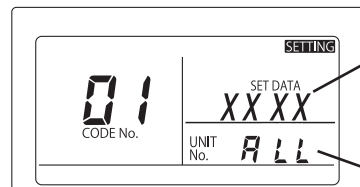
- (1) Press and hold the button and button for 4 seconds or longer (simple settings mode).
- (2) The address is displayed for the indoor unit that is connected to the remote controller.
(Only the address of the indoor unit that is connected to the remote controller can be checked.)
- (3) Press the button again to return to normal remote controller mode.



Number changes to indicate which indoor unit is currently selected.
Indoor unit address

<If multiple indoor units are connected to 1 remote controller (group control)>

- (1) Press and hold the button and button for 4 seconds or longer (simple settings mode).
- (2) "ALL" is displayed on the remote controller.
- (3) Next, press the button.
- (4) The address is displayed for 1 of the indoor units which is connected to the remote controller. Check that the fan of that indoor unit starts and that air is discharged.
- (5) Press the button again and check the address of each indoor unit in sequence.
- (6) Press the button again to return to normal remote controller mode.

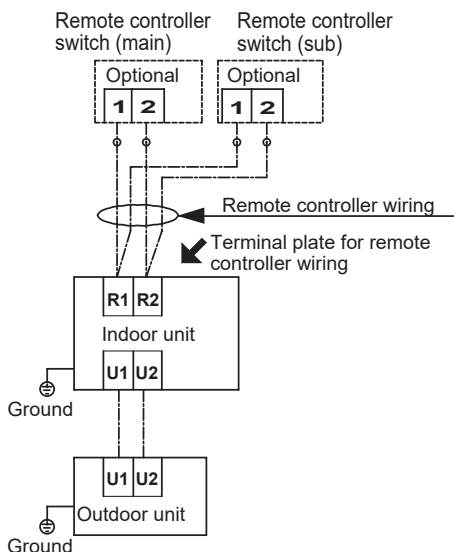


Number changes to indicate which indoor unit is currently selected.
Indoor unit address

2-8-4. Main-sub remote controller control

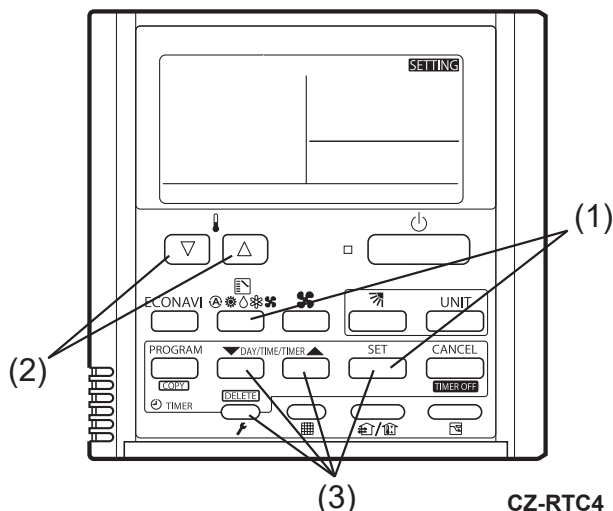
Control using 2 remote controller switches Main-sub remote controller control refers to the use of 2 remote controllers to control 1 or multiple indoor units. (A maximum of 2 remote controllers can be connected.)

● Connecting 2 remote controllers to control 1 Indoor unit



● Remote controller setting mode (CZ-RTC4)

- (1) Press and hold the 2 buttons for several seconds simultaneously.
- (2) Select the Code no.
- (3) Select the Set data. → .
The indicator illuminates after blinking. Press .



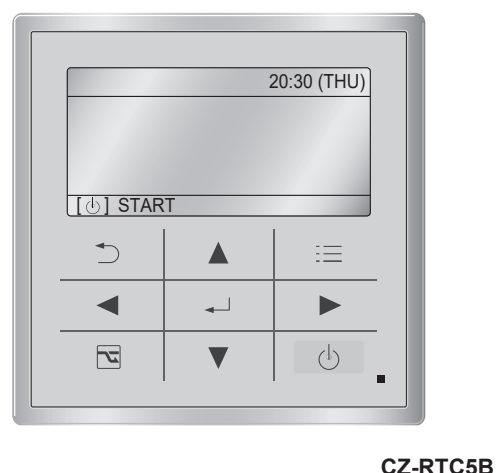
Code no.	Item	Set data	
		0000	0001
01	Main/Sub	Sub	Main

● Remote controller setting mode (CZ-RTC5B)

- (1) Press and hold the , , and buttons for 4 seconds or more simultaneously.
- (2) Select the item to set. → .

Maintenance func	20:30 (THU)
1. Outdoor unit error data	
2. Service contact	
3. RC setting mode	
4. Test run	
Sel. ◀ Page [↔] Confirm	
- (3) Set. (Select the Code no. and Set data.)
 → → .
 (Repeat)

RC setting mode	20:30 (THU)
Code no.	Set data
01	0001
Sel. ▶ Next	
- (4) Press .
 ●After Selecting [YES], the unit restarts.

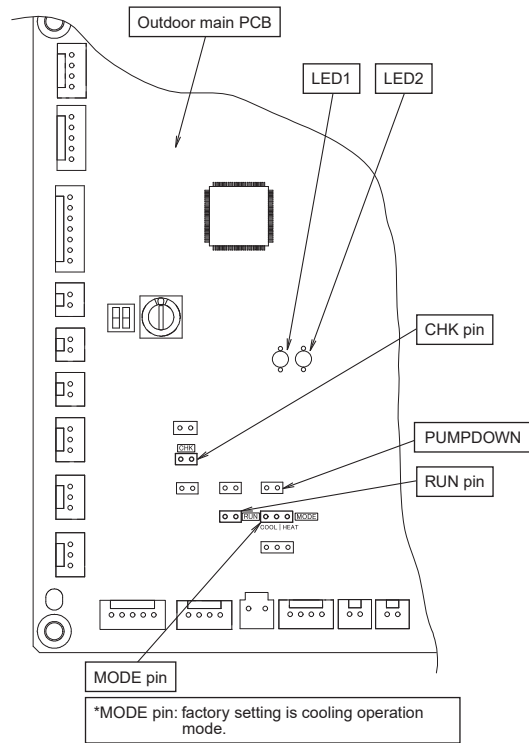


Code no.	Item	Set data	
		0000	0001
01	Main/Sub	Sub	Main

■ Outdoor Units

2-9. Test Run Procedure

- If there are duplicated system addresses, or if the settings for the Nos. of the indoor units are not consistent, an alarm will occur and the system will not start.
- Switch the power supply ON both indoor and outdoor unit.
- Short-circuit CHK pin on the outdoor main PCB. Do not remove CHK pin until test run is completed. Removing CHK pin stops test run.
- Short-circuit RUN pin on the outdoor main PCB for one second or longer. Factory setting is cooling operation mode and cooling operation test run starts. If heating operation starts, short-circuit both right side and centre of the MODE pin (centre and COOL) continuously.
- Ensure to conduct a test run. In addition, be sure to run the cooling operation test run for at least 20 minutes before starting the heating operation test run.
- To conduct heating operation test run, short-circuit left side and centre of the MODE pin (centre and HEAT) continuously.
- Removing CHK pin's and MODE pin's short-circuit stops test run.
- For the test run using remote controller, please see installation instructions included with the remote controller.

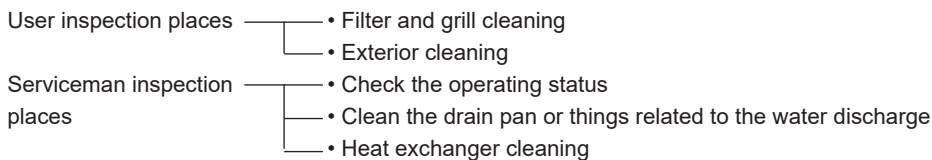


2-10. CHECKS AFTER INSTALLATION HAVE COMPLETED

- Check the following items after completing installation.
 - Is there a short circuit with the intake air flow?
 - Is the insulation secure? (Refrigerant tubing)
 - Are there any errors with the wiring?
 - Are the terminal screws loose? Tightening torque (Unit: N•m {kgf•cm})
M4...1.57~1.96{16~20}, M5...1.96~2.45{20~25}
 - Is the drain water flowing smoothly?
 - Is the insulation material properly installed?
 - Is the earth wire securely connected?
 - Is the front panel and the indoor unit air conditioner firmly fixed and was the installation completed without any leakage from the refrigerant?
 - Are the indoor and outdoor units secured firmly installed with bolts at secured locations?

2-11. REGARDING DELIVERY TO THE CUSTOMER

- Request the customer to review the operating instructions and explain the operating method for the product.
- In addition, it is also recommended that regular inspection checks are agreed upon for maintenance.



2-12. Caution for Pump Down

Pump down means refrigerant gas in the system is returned to the outdoor unit. Pump down is used when the unit is to be moved, or before servicing the refrigerant circuit.

How to perform Pump-Down (Refrigerant recovery) properly

- (1) Stop operation of the unit (cooling, heating etc.).
 - (2) Connect the pressure gauge to the service port of the gas tubing valve.
 - (3) Short-circuit the "PUMPDOWN" pin on an outdoor unit control PCB (CR) for more than 1 second to release.
 - Pump-Down begins and the unit starts operating.
 - During Pump-Down, LED1 blinks and LED2 is lit on an outdoor unit control PCB (CR).
 - "CHK" blinks on the remote controller.
 - (4) Fully close the liquid tubing valve 2-3 minutes later.

The Pump-Down will begin.
 - (5) When the pressure gauge drops to 0.1-0.2MPa, close the gas tubing valve tightly and short-circuit the "PUMPDOWN" pin for more than 1 second to release. That is the end of Pump-Down.
 - When running for more than 10 minutes, it stops even if the Pump-Down is not completed. Check the blocked state of the liquid tubing valve.
 - It also stops when the "PUMPDOWN" pin is short-circuited during the operation.
- * For compressor protection, do not operate to the point where the unit wiring side reaches negative pressure.

Note : In the case that inter-unit wiring is 30m or longer, you cannot pump-down.
(It may trigger the operation of the overload protection device.)
In this case, perform pump-down with pump-down device.

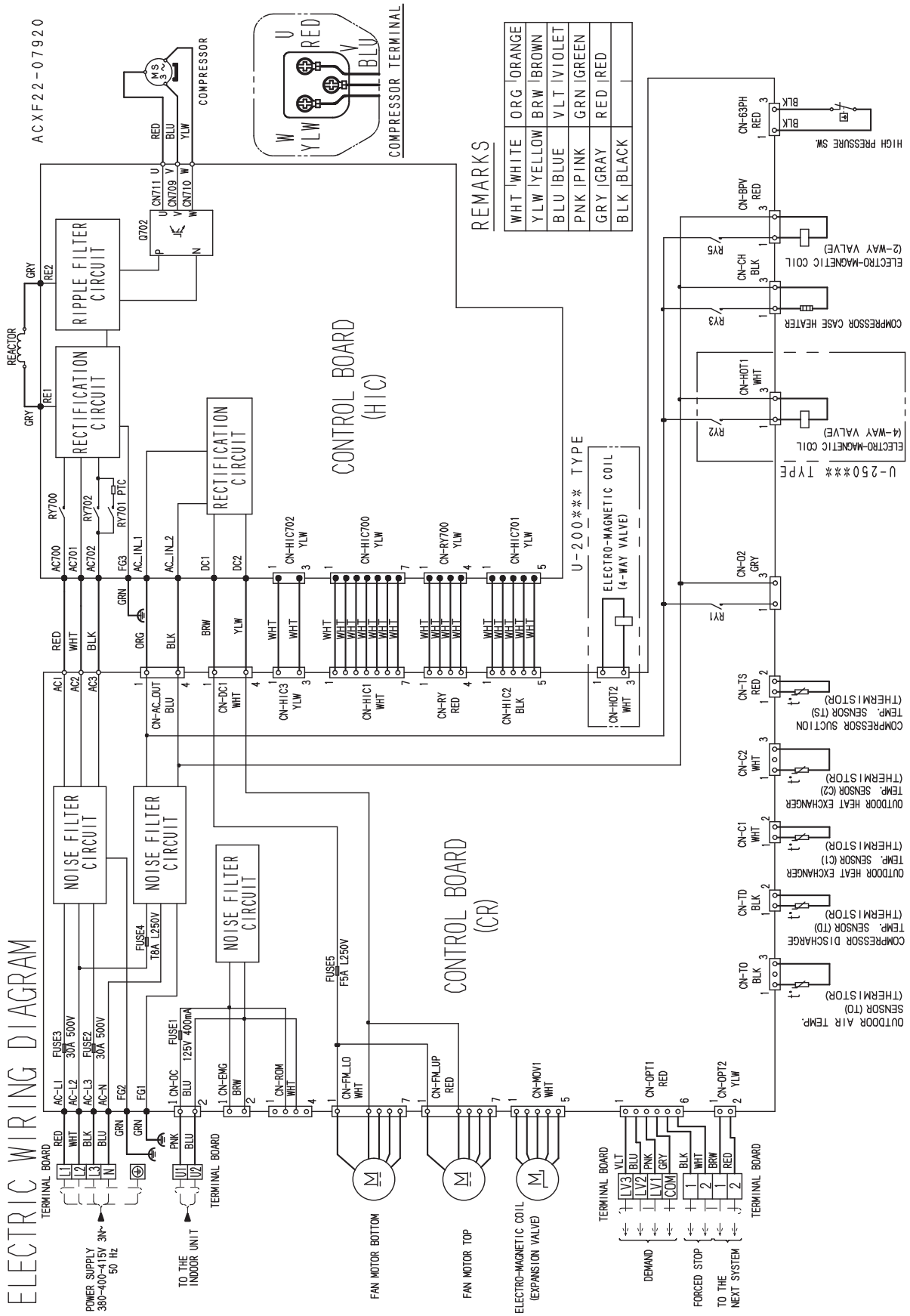
– MEMO –

3. ELECTRICAL DATA

3-1. Outdoor Units (Electric Wiring Diagram)	3-2
3-2. Indoor Units (Electric Wiring Diagram)	3-3
High Static Pressure Ducted Type	3-3
4-Way Cassette Type	3-5

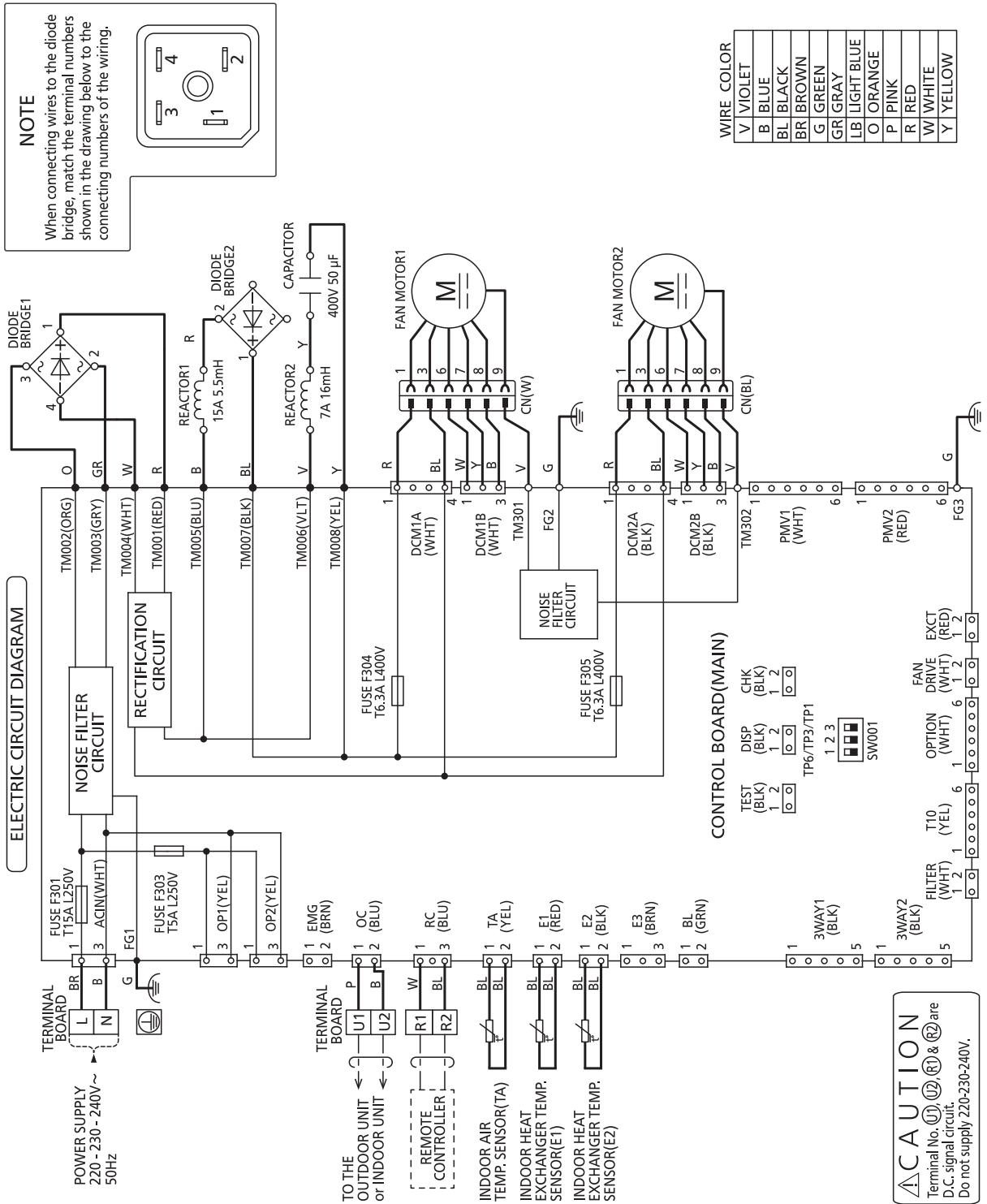
3-1. Outdoor Units

Electric Wiring Diagram U-200PZH2E8 / U-250PZH2E8



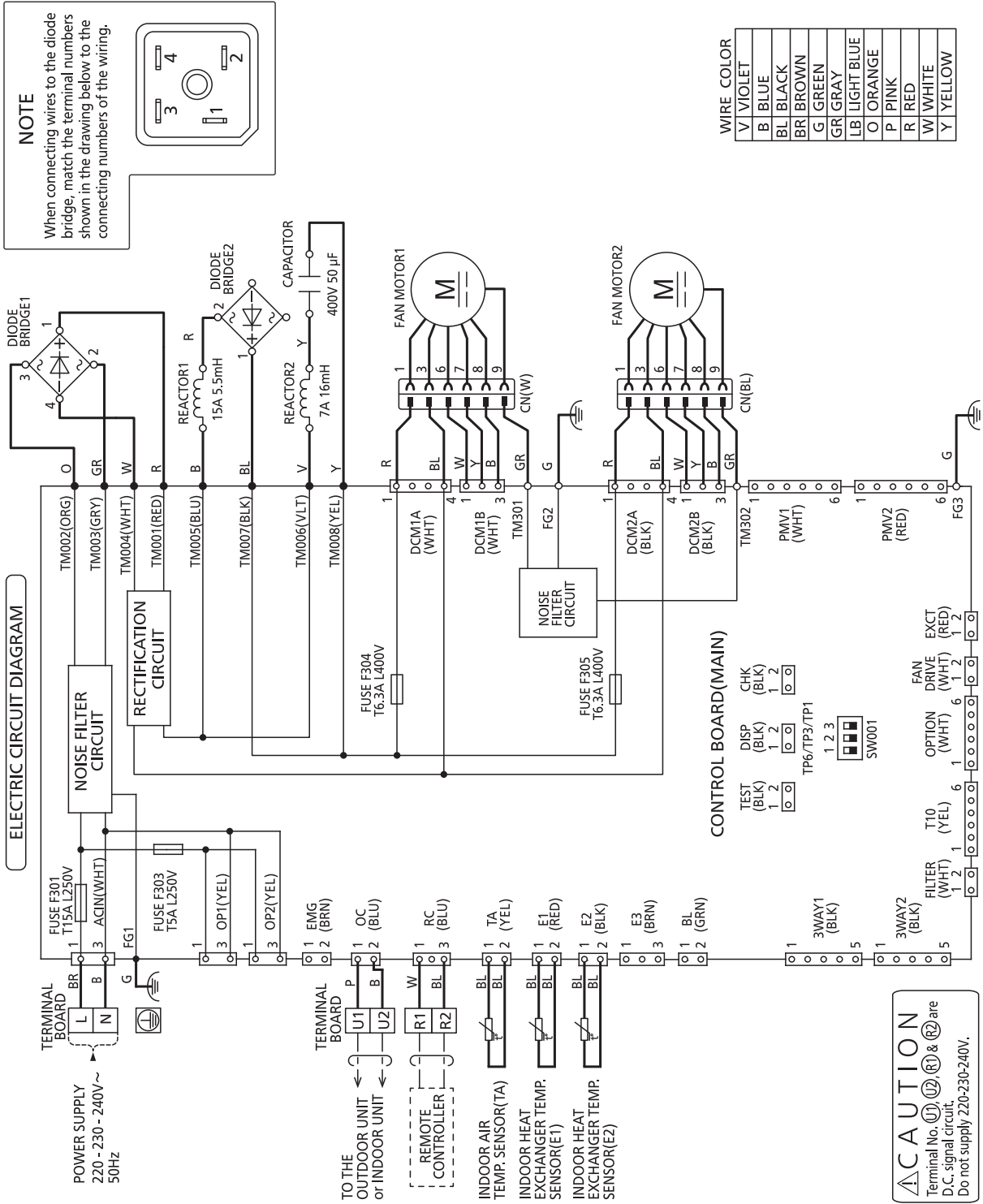
3-2. Indoor Units

High Static Pressure Ducted Type S-200PE3E5B Electric Wiring Diagram



ACXF20-10460/AA

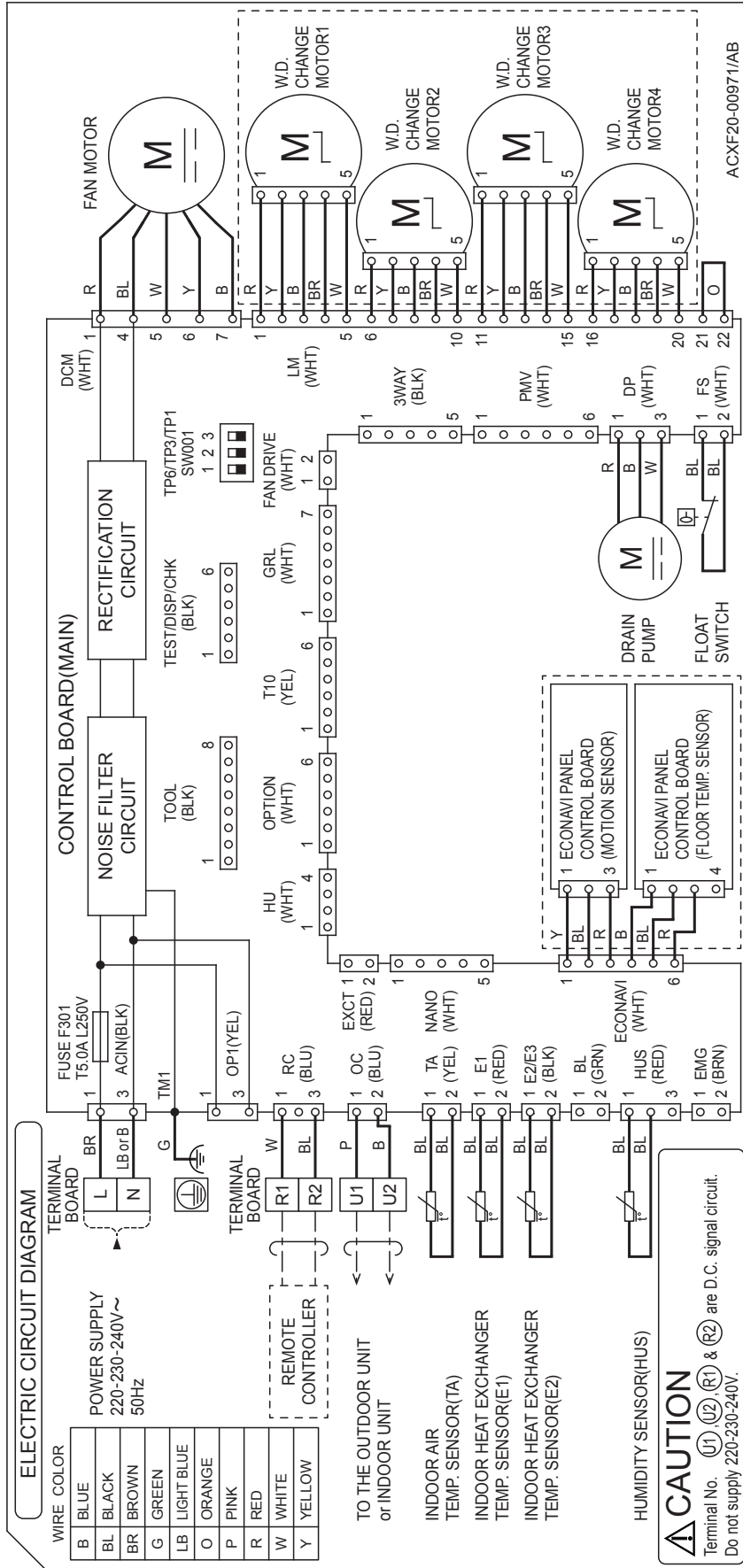
High Static Pressure Ducted Type S-250PE3E5B Electric Wiring Diagram



ACXF20-10470/AA

■ 4-Way Cassette Type S-50PU2E5B, S-60PU2E5B, S-71PU2E5B, S-100PU2E5B, S-125PU2E5B

Electric Wiring Diagram



– MEMO –

4. PROCESS AND FUNCTIONS

4-1. Control Functions.....	4 - 2
4-2. Outdoor Unit Control PCB (ACXA73-3030*, ACXA73-3028*)	4 - 9
4-3. Outdoor Unit HIC Board (ACXA73-3104*).....	4-15
4-4. Indoor Unit Control PCB Switches and Functions.....	4-16

4-1. Control Functions

1. Indoor Air Temperature Control

The thermostat is switched on and off in accordance with ΔT shown below.

$\Delta T = (\text{Indoor air temperature}) - (\text{Temperature set with the remote controller})$	
In the body thermostat mode (setting at factory shipment)	Indoor air temperature = (Body sensor) - (Shift temperature *)
In the remote controller thermostat mode	Indoor air temperature = (Remote controller sensor)

* Shift Temperature

Only valid during heating operation. Set at 0 °C during cooling operation.

The settings at factory shipment during heating operation are as follows:

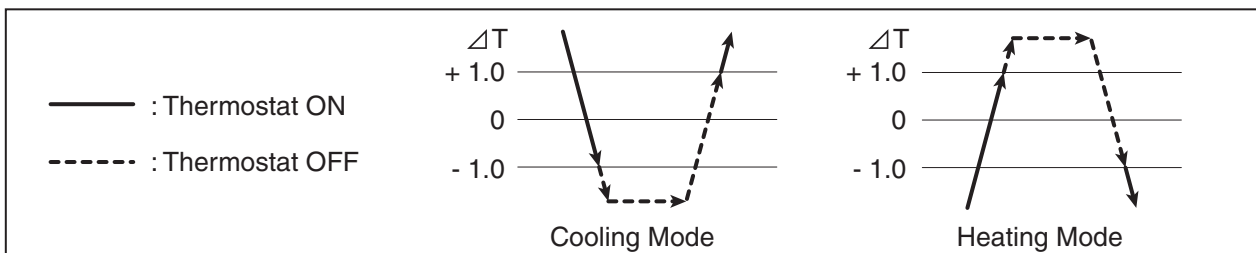
Wall-Mounted type : 2°C

Floor Standing type : 0°C

All other types (4-Way types, Concealed types, etc.) : 4°C

This function acts as the coefficient for adjusting differences in temperature caused by the height of the living space from the floor to the ceiling (the temperature at ceiling height is higher) during heating operation.

The setting can be modified between 0°C and 6°C with mode [06] (Simple Settings Function) on the remote controller.



- (1) Once the thermostat has been switched on, it cannot be switched off again by indoor air temperature control for a period of 10 minutes.
- (2) Once the thermostat has been switched off, it cannot be switched on again for a period of 3 minutes.
- (3) When in the test run operation mode, the thermostat will not be switched off by indoor air temperature control and the operation will continue.

2. Compressor Frequency Control

The frequency of the compressor's inverter is limited by either of the following controls depending on whether the cooling or heating mode is in operation.

Cooling Mode :

- Indoor air temperature control
- Maximum and minimum frequency control
- Current control
- Cooling high-load prevention control
- Cooling freeze prevention control
- Discharge temperature control

Heating Mode :

- Indoor air temperature control
- Maximum and minimum frequency control
- Current control
- Heating high-load prevention control
- Discharge temperature control

1) Indoor Air Temperature Control

By the control method, not only the thermostat is switched on and off, as explained section “1. Indoor Air Temperature Control”, but also the frequency of the compressor's inverter is controlled in accordance with ΔT and fluctuations in indoor air temperature. Inverter frequency is controlled as follows:

When ΔT is high (not yet reached the temperature set with the remote controller).	Controlled so that the inverter frequency is increased.
When ΔT is low (approximately +1.0 or less in the cooling mode or approximately -1.0 or more in the heating mode).	Controlled so that the inverter frequency is decreased or kept.

2) Maximum and Minimum Frequency Control

The compressor's inverter frequency is controlled in accordance with the model and operation mode. The maximum and minimum frequencies for each model are shown in the table below.

* There are cases in which frequency is limited with other control functions depending on operational conditions, so operations are not always carried out in accordance with the maximum frequencies listed below.

· Maximum and Minimum Frequency

		U-200PZH2E8	U-250PZH2E8
Maximum Frequency (Hz)	Cooling	70	90
	Heating	95	110
Minimum Frequency (Hz)	Cooling	13	13
	Heating	15	15

* There is a case in which the frequency set at maximum and minimum may sometimes decrease in accordance with ambient temperature and indoor loads.

3) Current Control

The inverter frequency is controlled so that the current value for the inverter compressor is less than the figure listed in the table below in order to prevent abnormal increases in the inverter circuit located within the outdoor unit's electrical box.

Current control with primary current : The limited values are modified in accordance with ambient temperature.

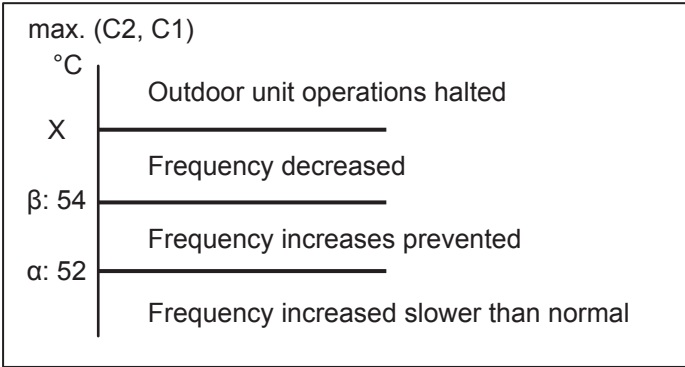
		U-200PZH2E8	U-250PZH2E8
Is (A)	Cooling	12.5	15.5
	Heating	13.5	18.5

4) Condensation Temperature Control (cooling)

This system control is performed to limit the inverter frequency in order to restrict high pressure's abnormal increase and high-load operating prevention in the cooling mode.

In accordance with the temperature of the outdoor heat exchanger temperature sensors (C1, C2), such controls are performed as to halting the operations of the indoor unit, decreasing the inverter frequency and restricting its increase, etc.

- (a) The threshold value is decreased in accordance with the compressor frequency or indoor load (differences of temperature).
- (b) When "X" values are lowered, the results basically become $\beta=X-2$, $\alpha=X-3$.



Outdoor EEPROM : Amendment of X values can be made due to 4B.

EEPROM setting in outdoor unit
CODE: 4B

Setting No.	-2	-1	0	1 *
X (°C)	52	56.5	58.5	60

* Setting at factory shipment

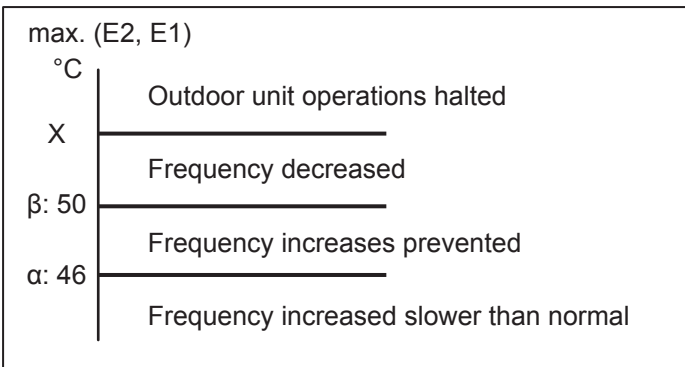
4

5) Condensation Temperature Control (heating)

This system control is performed to limit the inverter frequency in order to restrict high pressure's abnormal increase and high-load operating prevention in the heating mode.

In accordance with the temperature of the indoor heat exchanger temperatures sensor (E1, E2), such controls are performed as to halting the operations of the indoor unit, decreasing the inverter frequency and restricting its increase, etc.

- (a) The threshold value is decreased in accordance with the compressor frequency or indoor load (differences of temperature).
- (b) When "X" values are lowered, the results basically become $\beta=X-2$, $\alpha=X-3$.



Outdoor EEPROM : Amendment of X values can be made due to 4B.

EEPROM setting in outdoor unit
CODE: 4B

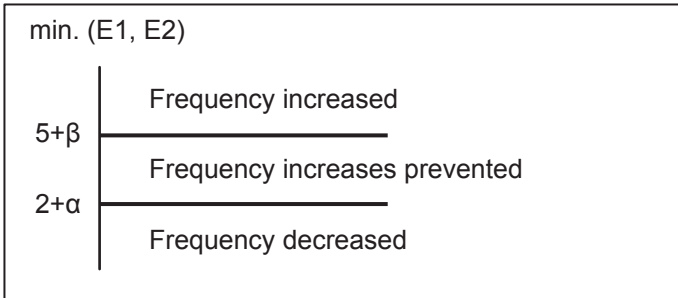
Setting No.	-2	-1	0	1 *
X (°C)	52	56.5	58.5	60

* Setting at factory shipment

6) Cooling Freeze Prevention Control

The following control is performed during cooling operations (including dry mode operation), in accordance with whichever of the indoor heat exchanger temperatures (E1 or E2) is lower. (See the chart below.)

- (a) Frequency will not be decreased less than 6 minutes after thermostat ON.
- (b) The threshold value is increased in accordance with the indoor load (differences of temperature).



Outdoor EEPROM : Amendment of α and β values can be made due to 3F or 40.

EEPROM setting in outdoor unit

CODE: 3F (for α setting)

Setting No.	-15	0 *	9
α	-15		0		9

CODE: 40 (for β setting)

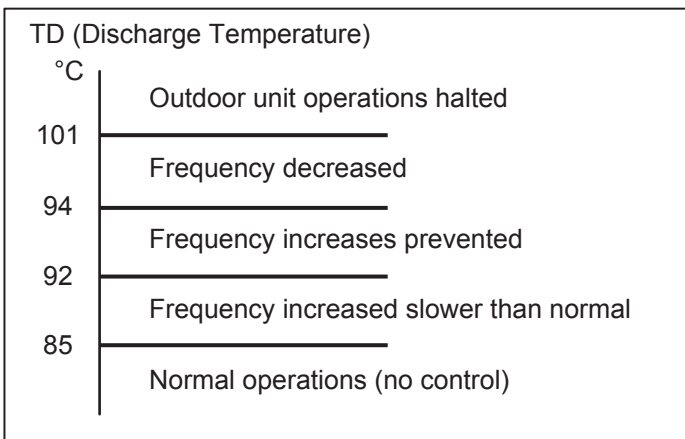
Setting No.	-15	0 *	9
β	-15		0		9

* Setting at factory shipment

7) Discharge Temperature Control

The following control is performed to prevent the discharge temperature from rising abnormally in order to protect the inverter compressor.

In accordance with the temperature of the discharge sensor TD, such controls are performed as to limiting the increase of inverter frequency, decreasing it or halting operation of the compressor.



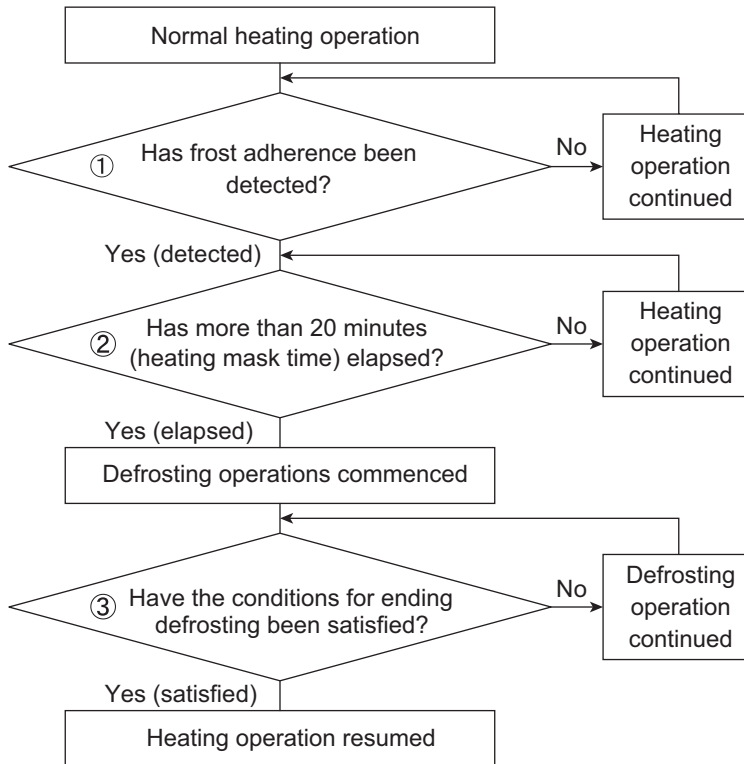
* If the discharge temperature exceeds 101°C, operations of the compressor are halted and restarted after 3 minutes.

If this start/stop activity is repeated 4 times, the alarm "P03" (abnormal discharge temperature) occurs.

8) Defrosting Control

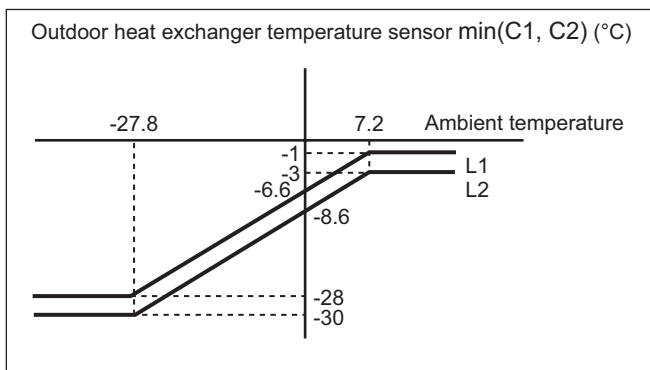
This control function removes frost that has adhered to the outdoor heat exchanger during the heating operation. The control is performed to prevent the deterioration of the heating capabilities attributed to the adherence of frost, and to prevent the crack or crush of pipes attributed to the accretion of ice. The following control is performed in accordance with the ambient temperature and the outdoor heat exchanger temperature sensor (C1).

Overall Flow Chart of Defrosting Control



① Frost adherence detection

- If the following conditions are satisfied during heating operations, it is regarded as “frost adherence is detected”.
- Frost adherence detection is performed in accordance with the ambient temperature (TO) and the outdoor heat exchanger temperature sensor min(C1, C2).
- Frost adherence detection conditions
 - (a) Following satisfied condition is detected for accumulation of 60 minutes.
Outdoor heat exchanger temperature sensor $\min(C1, C2) \leq L1$
 - (b) Following satisfied condition is detected for consecutive 1 minutes or more, 2 times.
Outdoor heat exchanger temperature sensor $\min(C1, C2) \leq L2$



- (c) Following satisfied condition is detected for accumulation of over 80 minutes.
Outdoor heat exchanger temperature sensor $\min(C1, C2) < -3 \text{ }^\circ\text{C}$

② Heating Mask Time

This refers to the shortest time that heating operations must be performed without defrosting operations being executed. The mask time for this model is 20 minutes.

- * Defrosting operations will not be commenced until the defrosting mask time has elapsed, even if frost adherence has been detected.

③ Ending Defrosting

Defrosting operations are ended when the following conditions are satisfied.

- Ending defrosting conditions
 - (a) When the temperature of the outdoor heat exchanger temperature sensor (C1) is 10°C or higher.
 - (b) When the temperature of the outdoor heat exchanger temperature sensor (C1) is 6°C or higher for consecutive 60 seconds.
 - (c) When a maximum of 15 minutes defrosting time has elapsed.

9) Outdoor Unit Fan Control

The appropriate rotations per minute for the outdoor unit fan are determined in accordance with the ambient temperature and the frequency of the compressor inverter.

The outdoor unit fan step is controlled between a range of W0 (Step 1) and WF (Step 16).

10) Outdoor Unit's Electrical Expansion Valve Control

The electrical expansion valve controls the amount of refrigerant that is allowed to flow in accordance with the operation status.

The valve is adjusted in accordance with the discharge temperature (TD), the outdoor heat exchanger temperature sensor (C1), the suction temperature sensor (TS), and the indoor unit's heat exchanger temperature sensors (E1 and E2).

(1) Cooling Mode

Controlled so that the suction temperature (TS) - indoor heat exchanger temperature minimum (E1 and E2) is between 0 degree and 2 degrees under normal conditions.

There are cases where the aperture opens wider than normal operation if the discharge temperature increases.

(2) Heating Mode

Controlled so that the suction temperature (TS) - outdoor heat exchanger temperature (C1) is between 0 degree and 2 degrees under normal conditions.

There are cases where the aperture opens wider than normal operation if the discharge temperature increases.

11) Demand Control

There is a demand terminal as normal equipment in the outdoor unit.

Demand control can be selected as the following table.

Input current should be DC24V, 10mA

Connecting wiring must be used "shield wiring".

Short-circuit			Control (range of operations)
LV3-COM	LV2-COM	LV1-COM	
0	0	0	No restricted
0	0	1	Rated current restricted to A% (A% = 75% at factory shipment)
0	1	0	Rated current restricted to B% (B% = 50% at factory shipment)
1	0	0	Control OFF

* The operational current is restricted to either A% or B% as a general indicator during demand input.

- A% and B% can be amended in calibrations of 5% between 70% and 100% with the outdoor unit's maintenance remote controller.

For details on how to amend the parameters, see the chapter on the outdoor maintenance remote controller, (refer to the section "6-6. Settings Modes : Setting the Outdoor Unit EEPROM").

- A% value amendments: Parameters are amended with item code "1A" (demand 1).
- B% value amendments: Parameters are amended with item code "1B" (demand 2).

12) Silent mode

It is available to select one of 3 levels of silent mode as listed in the table below.

Outdoor maintenance remote controller: Item code "05" (1: Silent level 1, 2: Silent level 2, 3: Silent level 3)

Attention: Due to decrease of operating noise level, the air conditioner's capacity can be reduced.

Silent mode is ineffective during the test run operation.

Model		U-200PZH2E8	U-250PZH2E8
Operating mode		dB(A)	dB(A)
Cooling	Rated value	59	59
	Silent level 1	57	57
	Silent level 2	55	55
	Silent level 3	53	53
Heating	Rated value	61	63
	Silent level 1	59	61
	Silent level 2	57	59
	Silent level 3	55	57

There are two types of conditions when entering into a silent mode.

(1) From external input: When short-circuiting the silent pin of the outdoor unit control PCB

(2) From software input: The automatic silent-mode operation can be available in the following procedure.

(However, use the Schedule Timer to set the present time and check for the Schedule Timer from the outdoor unit.)

Set up silent mode by using the outdoor maintenance remote controller. (For operating procedure, see the Section "6. OUTDOOR UNIT MAINTENANCE REMOTE CONTROLLER".)

① Silent mode setting: Select the Item code "12" by the maintenance remote controller.

② Parameter: 0 = Normal [No silent mode] (Setting at shipment)

: 1 = Silent mode [Restrict the outdoor unit fan and compressor.]

: 2 = Capacity first rather than silent mode *1 [Stop restricting silent mode in the following condition.]

: 3 = Silent mode timer

: 4 = Timer capacity first rather than silent mode *1

• Capacity first rather than silent mode (*1)

Condition: If the temperature difference of 2 degrees or more comparing to the set temperature continues for 30 minutes, stop silent-mode operation and return to normal operation. [Capacity first]

Cancellation: When the temperature difference comparing to the set temperature becomes within 1 degree, the unit will return to silent mode.

• The outdoor unit checks the Schedule Timer every 1 minute.

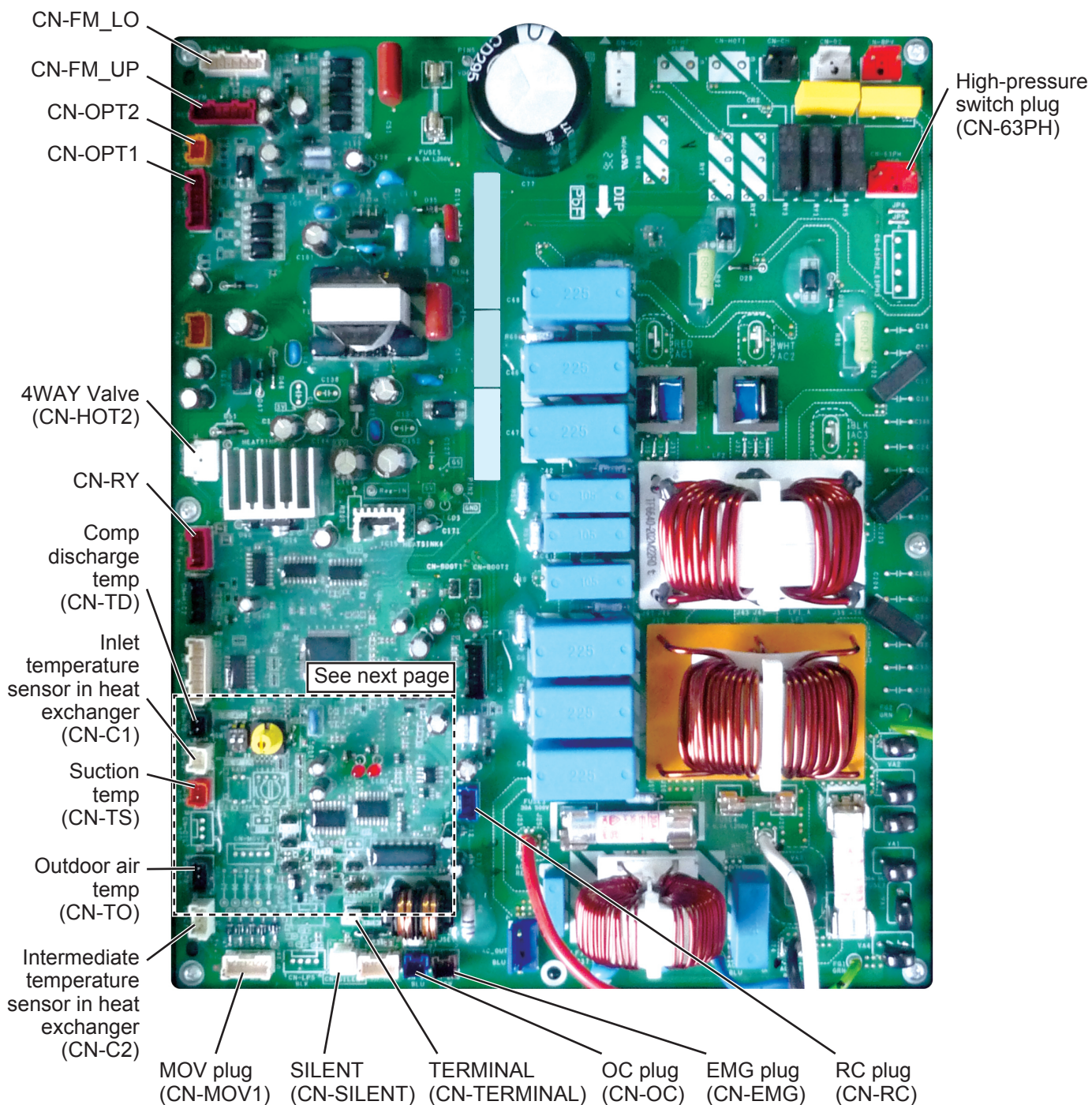
[Set the address of the Schedule Timer to "1". (Turn the Setting switch S41 #5-7 to Off.)]

• If the communication with the silent-mode cancellation Schedule Timer is interrupted for 30 minutes, silent-mode is canceled.

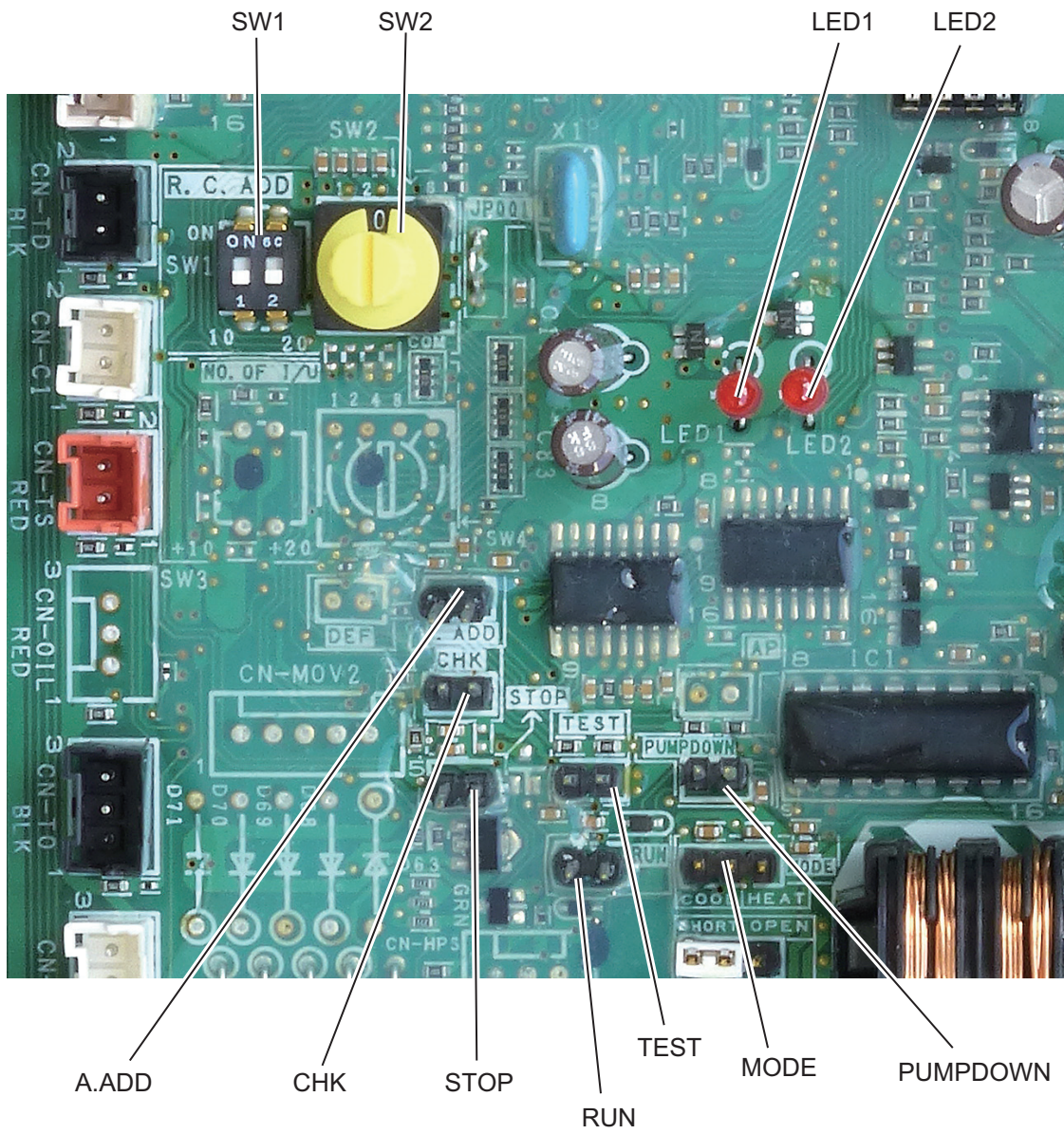
③ Start time setting: (Setting time at shipment 22:00) → Time: Item code 13/minute: Item code 14

④ Stop time setting: (Setting time at shipment 08:00) → Time: Item code 15/minute: Item code 16

4-2. Outdoor Unit Control PCB U-200PZH2E8 (ACXA73-3030*)

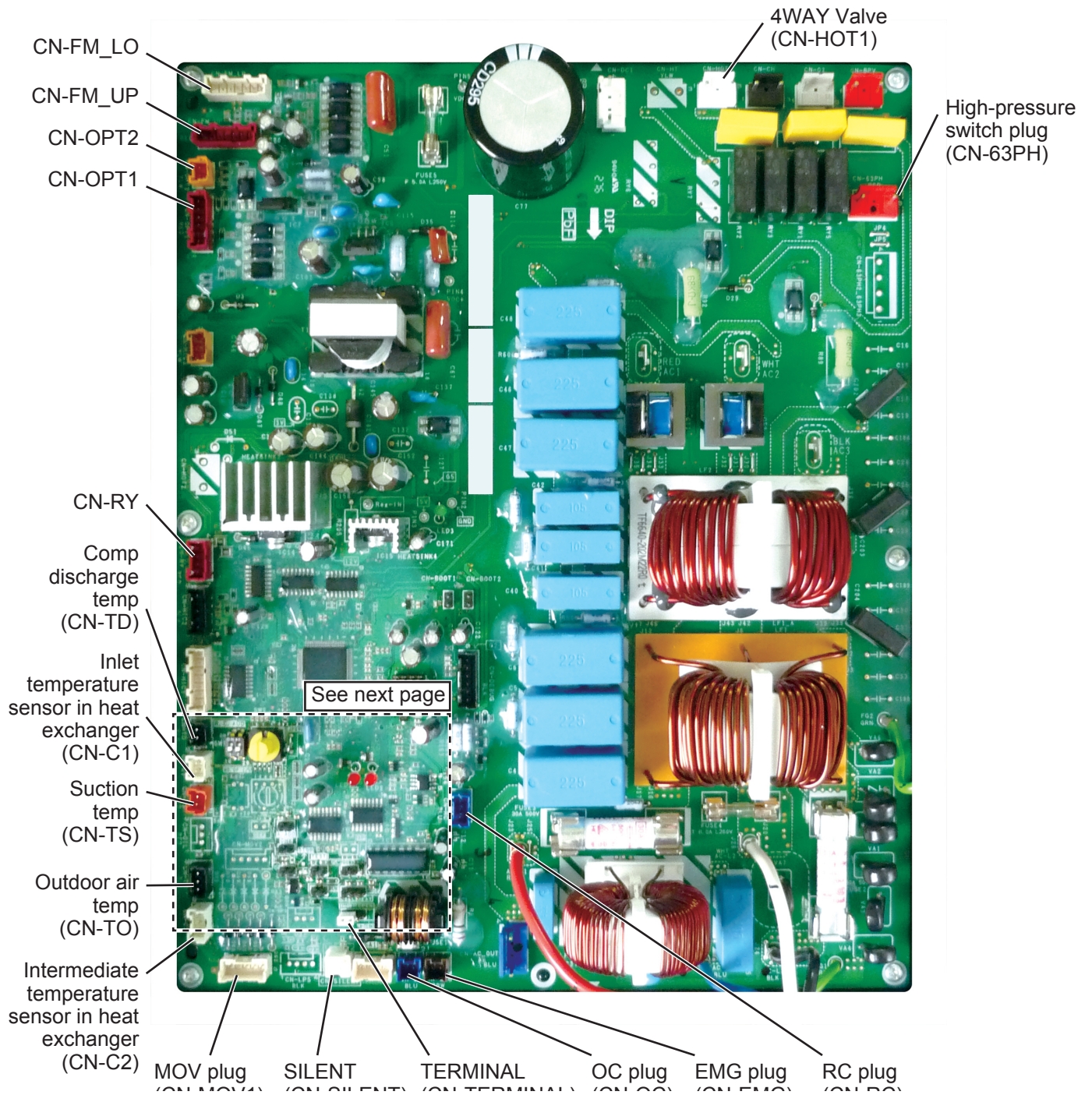


U-200PZH2E8 (ACXA73-3030*)

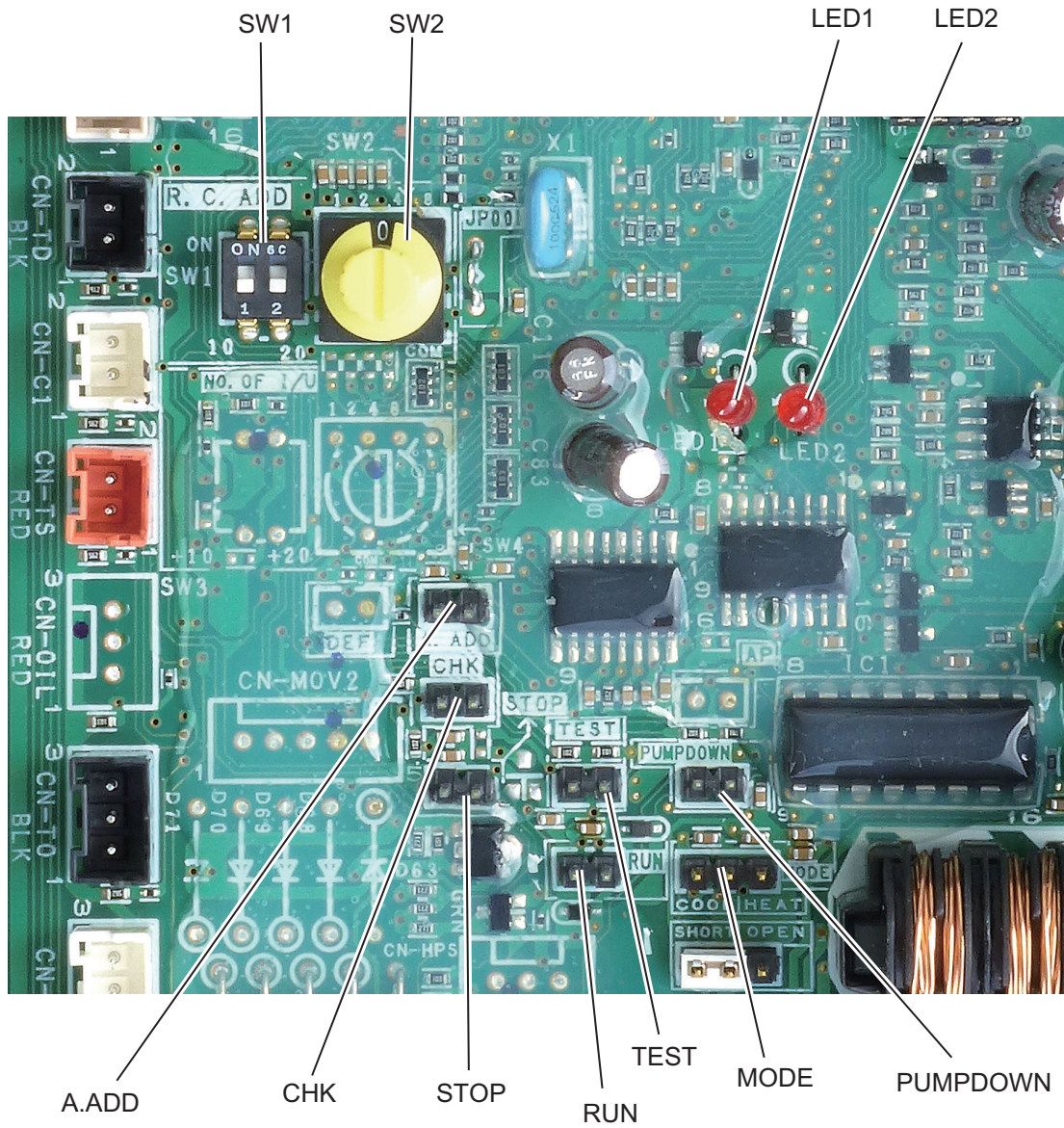


4

U-250PZH2E8 (ACXA73-3028*)



U-250PZH2E8 (ACXA73-3028*)



4

Outdoor Unit Control PCB (ACXA73-3030*, ACXA73-3028*)

Explanation of Functions

A. ADD pin	(2P, Black)	<p>Auto address setting pin</p> <ul style="list-style-type: none"> • Short-circuit this pin for 1 second or longer to automatically set the addresses at the indoor units that are connected to that outdoor unit and are within the same system. • The system address is "0" at the time of shipment. Auto address setting is necessary even for communications lines in a single system where the inter-unit control wiring does not cross to any other systems. • While auto address setting is in progress, the 2 LEDs (LED1, 2: Red) on the outdoor unit control PCB blink alternately. (Short-circuiting this pin while auto address setting is in progress will stop the auto address setting operation.)
SW2 Rotary switch	(10 positions, Yellow)	<p>Outdoor system address setting switch</p> <ul style="list-style-type: none"> • The setting is "0" at the time of shipment. It is not necessary to change the setting if wiring is connected only to an outdoor unit and indoor units in a single system and the inter-unit control wiring does not cross multiple systems. • If wiring links the inter-unit control wiring for multiple systems to the same communications lines, then a different address must be set for each refrigerant tubing system. • If wiring links multiple systems, a maximum of 30 systems (up to 64 indoor units) can be connected. This setting can be set up to "39," however control will be for 30 systems even if the setting is set to higher than 30. An alarm will be displayed if system addresses are duplicated. (For details, see Table 4-1.)
SW1 DIP switch	(2P, Black)	<p>Switches for setting system address 10s digit and 20s digit</p> <ul style="list-style-type: none"> • If 10 systems or more are set, the setting is made by a combination of this DIP switch and SW2. • If 10 - 19 systems are set, set switch 1 (10s digit) to ON. • If 20 - 29 systems are set, set switch 2 (20s digit) to ON, and set switch 1 (10s digit) to OFF. • If 30 systems are set, set both switch 1 (10s digit) and switch 2 (20s digit) to ON. (For details, see Table 4-1.)
PUMP DOWN	(2P, Black)	<p>Refrigerant recovery Pin</p> <ul style="list-style-type: none"> • Short circuit this pin to perform refrigerant recovery control using cooling operation. The indoor unit fan will operate at HIGH and 60Hz for a maximum of 10 minutes. When refrigerant recovery is completed, close the valves and open circuit this pin to stop the operation.
LED 1 LED 2	(D302) (D303)	<p>LED (red × 2)</p> <ul style="list-style-type: none"> • LED 1 and 2 blink alternately while automatic address setting is in progress. • Display the alarm contents for alarms that are detected by the outdoor unit.
RUN	(2P, Black)	<p>Start pin</p> <ul style="list-style-type: none"> • Short-circuit this pin and apply a pulse signal to start all indoor units in that refrigerant system.
Stop	(2P, Black)	<p>Stop pin</p> <ul style="list-style-type: none"> • Short-circuit this pin and apply a pulse signal to stop all indoor units in that refrigerant system.
Mode change	(3P, Black)	<p>Indoor unit Heating/Cooling mode change pin</p> <ul style="list-style-type: none"> • Short-circuiting this pin during ordinary operation changes the mode from Cooling to Heating (if the current mode is Cooling) or from Heating to Cooling (if the current mode is Heating).
Test	(2P, Black)	<ul style="list-style-type: none"> • This pin is used to test the PCB at the factory. • When the power is turned ON after this pin has been short-circuited, all output signals will be output in sequence. (Sequential output does not occur if this pin is short-circuited when the power is already ON.) Releasing this pin returns the unit to normal control.
CHK	(2P, Black)	<ul style="list-style-type: none"> • Short-circuit during the test run operation. • Open the circuit after the test run.

Table 4-1. Method of System Address Setting

[SW2 (rotary, yellow), SW1 (2P DIP switch, black)]

	Outdoor system address No.	SW2 setting (system address switch)	SW1 setting	
			1P (10s-digit place)	2P (20s-digit place)
1 system only	1	0	OFF	OFF
Central control	1	1	OFF	OFF
	2	2	OFF	OFF
	3	3	OFF	OFF
	4	4	OFF	OFF
	5	5	OFF	OFF
	6	6	OFF	OFF
	7	7	OFF	OFF
	8	8	OFF	OFF
	9	9	OFF	OFF
	10	0	ON	OFF
	11	1	ON	OFF
	12	2	ON	OFF
	13	3	ON	OFF
	14	4	ON	OFF
	15	5	ON	OFF
	16	6	ON	OFF
	17	7	ON	OFF
	18	8	ON	OFF
	19	9	ON	OFF
	20	0	OFF	ON
	21	1	OFF	ON
	22	2	OFF	ON
	23	3	OFF	ON
	24	4	OFF	ON
	25	5	OFF	ON
	26	6	OFF	ON
	27	7	OFF	ON
	28	8	OFF	ON
	29	9	OFF	ON
	30	0	ON	ON

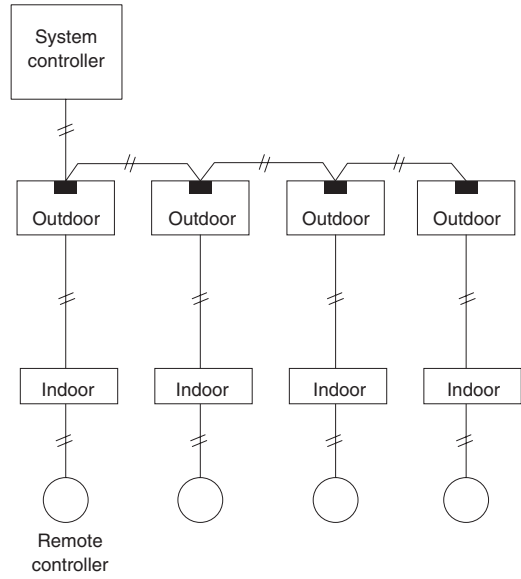
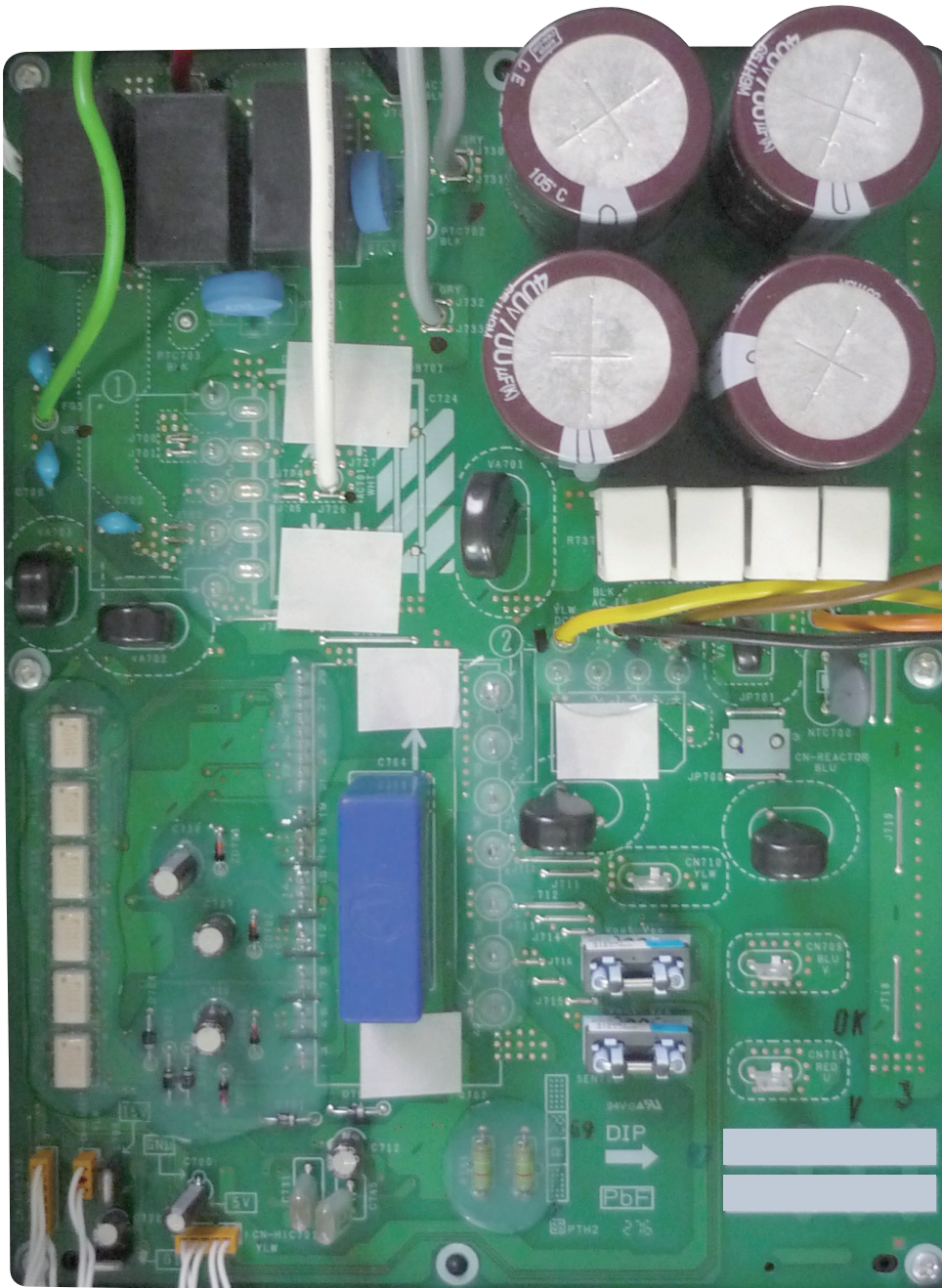


Fig. 1

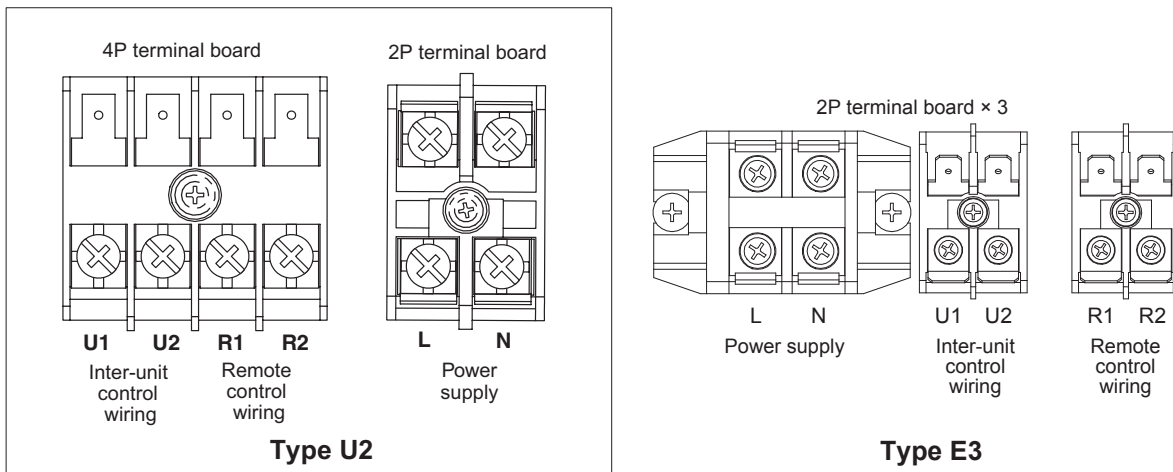
4-3. Outdoor Unit HIC Board
U-200PZH2E8, U-250PZH2E8 (ACXA73-3104*)



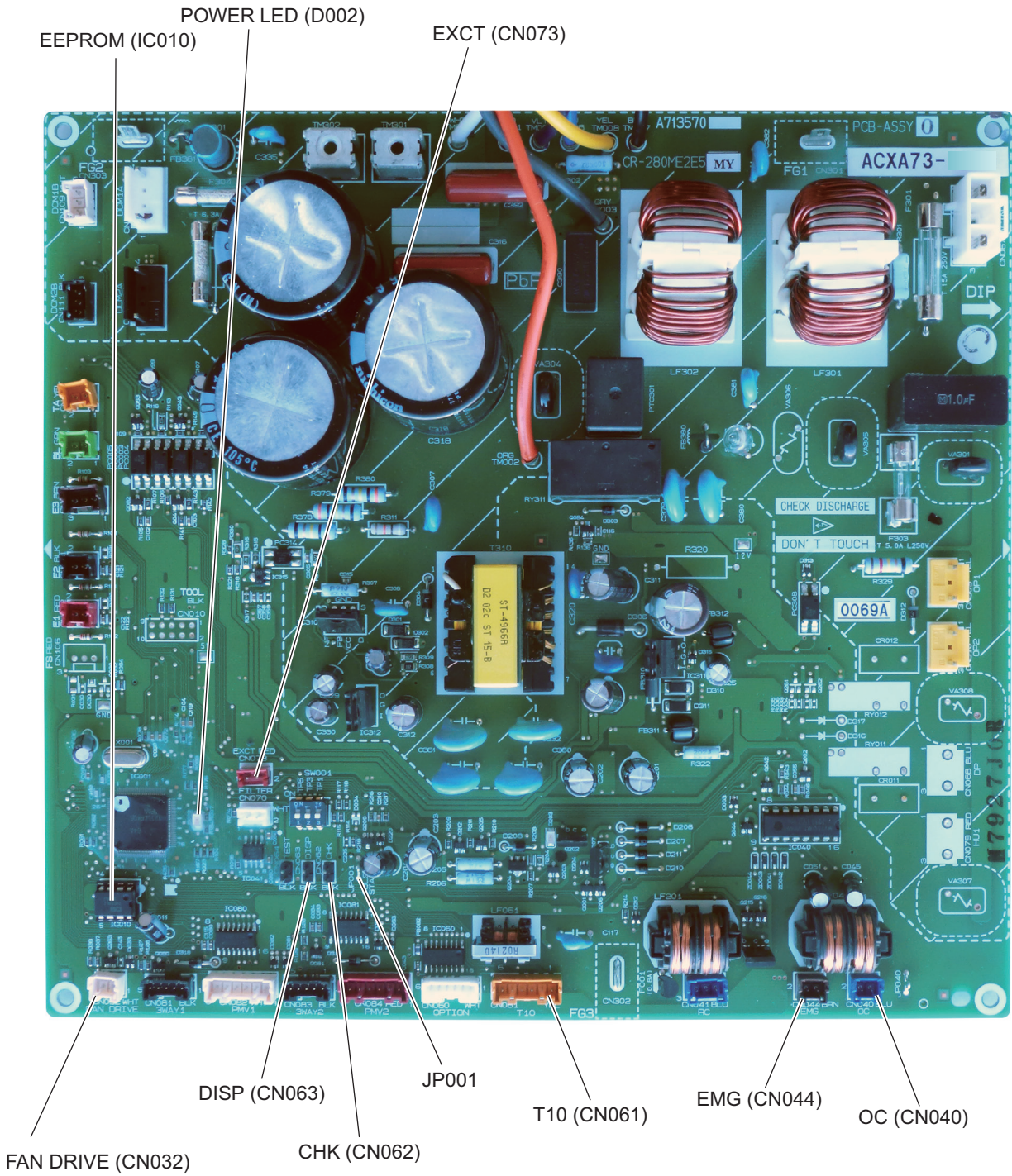
4-4. Indoor Unit Control PCB Switches and Functions

[Indoor unit control PCB]

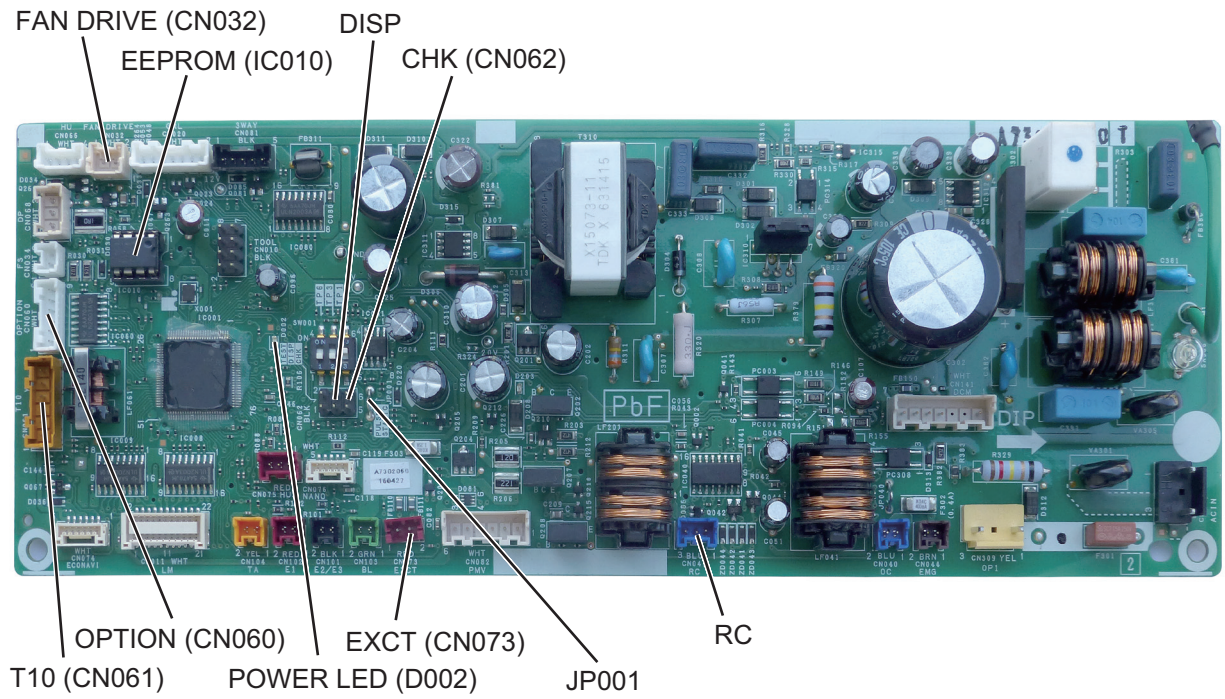
- T10 (CN061):** **6P plug (YEL)** / Used for remote control operation. (Refer to the Remote Control Section.)
 Control items: (1) Start/stop input (2) Remote controller prohibit input
 (3) Start signal output (4) Alarm signal output
- EXCT (CN073):** **2P plug (RED)** / Can be used for demand control. When input is present, forces the unit to operate with the thermostat OFF.
- DISP (CN063):** **2P plug (BLK)** / Short-circuiting this plug allows operation to be controlled by the remote controller even when an outdoor unit is not connected. (In this case, alarm "E04," which indicates trouble in the serial communication between the indoor and outdoor unit, does not occur.)
- CHK (CN062):** **2P plug (BLK)** / Test pin. Short-circuiting this pin allows the indoor FM (H fan speed), drain pump, flap motor (F1 position), and electronic expansion valve full-open position to be checked.
 However this function turns OFF if the indoor unit protection mechanism is activated. The components will operate even if the remote controller and outdoor unit are not connected, however the remote control cannot be used for control even if it is connected. This plug can be used for short-term tests.
- JP1 (JP001):** **Jumper wire** / Allows selection of the T10 terminal start/stop signal. (Refer to the Remote Control Section.)
 Setting at time of shipment: Pulse signal
 Jumper wire cut: Static signal (continuous signal)
- Fan drive (CN032):** **2P plug (WHT)** / This terminal sends the signal to the ventilation fan when a commercially available ventilation fan is operated by the FAN button on the wired remote controller. (Refer to the Remote Control Section.)
 Use a ventilation fan which can accept the no-voltage contact A signal as the external input signal.
- Power LED:** **LED (RED)** / Illuminates when the power is ON. Flashes when there is trouble with the EEPROM (IC10, IC010: nonvolatile memory).
- EEPROM (IC010):** **Nonvolatile memory** / Used to store model information and other data. When replacing the PCB, remove the EEPROM from the old PCB and install it onto the new PCB. If there is IC trouble, replace with a new IC (provided with the servicing PCB), and set the necessary information using the wired remote controller. (For the setting procedure, refer to the servicing technical materials.)



■ Indoor Unit Control PCB (ACXA73-3081*) : S-200PE3E5B, S-250PE3E5B



■ Indoor Unit Control PCB (ACXA73-2553*) : S-50PU2E5B, S-60PU2E5B, S-71PU2E5B, S-100PU2E5B, S-125PU2E5B



5. TROUBLE DIAGNOSIS

5-1.	Contents of Remote Controller Switch Alarm Display	5-2
5-2.	Outdoor Unit Control Panel LED Display	5-4
5-3.	PAC System Alarm Codes	5-5
5-4.	Inspection of Parts (Outdoor Unit)	5-32
5-5.	Symptom: Thermostat in OFF continues or cycles OFF & ON too frequently	5-33
5-6.	Table of Thermistor Characteristics	5-34
5-7.	How to Remove the Compressor	5-35
5-8.	How to Remove the Electrical Component Box	5-36
5-9.	Symptom: Thermostat in OFF continues or cycles OFF & ON too frequently	5-37

5-1. Contents of Remote Controller Switch Alarm Display

ON: ○ Blinking: ☀ OFF: ●

Possible cause of malfunction		Wired remote control display	Wireless remote controller receiver display		
			Operation	Timer	Standby
Serial communication errors Missetting	Failure in receiving serial signal from remote controller's indoor unit	Faulty remote controller Disconnection/Contact failure of remote controller wiring CHK(check) pins on the indoor unit control PCB are short circuited			
	Settings of system address, indoor unit address and group control are not made	In the case of non-group control: • Power supply OFF of outdoor unit • Disconnection / Contact failure of inter-unit wiring In the case of group control: Automatic address operation was not carried out.	E01	Operating lamp blinking ☀ ● ●	
	Setting failure of nonvolatile memory IC	Faulty setting of EEPROM on indoor unit			
	Failure in indoor unit serial signal from remote controller	Faulty remote controller Wrong wiring of remote controller	E02		
	Error in indoor unit receiving signal from remote controller (central)		E03		
	Failure in indoor unit receiving serial signal from outdoor unit	Disconnection / Contact failure of inter-unit wiring • Faulty indoor unit control PCB • Faulty outdoor unit control PCB • Communication circuit fuse on indoor unit control PCB opened	E04	Standby lamp blinking ● ● ☀	
		• Fuse on outdoor unit control PCB opened Since failure of an outdoor fan motor is considered as a cause, both outdoor unit control PCB and outdoor unit fan motor are exchanged simultaneously.			
	Failure in outdoor unit receiving serial signal from indoor unit	• Disconnection / Contact failure of inter-unit wiring • Disconnection of inter-unit wiring • Communication circuit fuse on indoor unit control PCB opened	E06	● ● ☀	
		Indoor unit control PCB address setting error			
	Duplication of indoor unit address	Duplication of indoor unit address setting	E08		
	Duplication of main remote controller setting	Error because of more than one remote controller setting to main	E09		
	Improper setting	Automatic address setting start is prohibited	E12	Operating lamp blinking ☀ ● ●	
		Duplication of main unit in group control	E14	☀ ● ●	
	Communication error between main and sub indoor units	• Disconnection of wiring between main unit and additional units • Contact failure of wiring • Faulty indoor unit control PCB (Main or Addition)	E18	☀ ● ●	
	Automatic address settings failure	Automatic Address Alarm The total capacity of indoor units is too low	E15		
		Automatic Address Alarm The total capacity of indoor units is too high	E16	Standby lamp blinking ● ● ☀	
		Automatic Address Alarm No indoor unit connected	E20	● ● ☀	
	Outdoor unit Communication error		E24		
	Outdoor unit Communication error		E29		
	Indoor & outdoor unit type miss-matched	Setting error, indoor/outdoor unit type/model miss-matched	L02		
Duplication of group control's main indoor unit	Duplication of main indoor unit address in group control	L03	Operating and standby lamps blinking simultaneously ☀ ● ☀		
Group control wiring is connected to individual control indoor unit	Group control wiring is connected to individual control indoor unit	L07	☀ ● ☀		
Indoor unit address is not set		L08	☀ ● ☀		
Indoor unit capacity is not set		L09			
Duplication of outdoor unit address		L04			
Outdoor unit capacity is not set or setting error		L10	Operating and standby lamps blinking simultaneously ☀ ○ ☀		
Indoor unit type setting error Type of indoor/outdoor units is different		L13	☀ ○ ☀		
4-way valve locked trouble / operation failure		L18	☀ ○ ☀		

Continued

ON: ○ Blinking: ☀ OFF: ●

Possible cause of malfunction		Wired remote control display	Wireless remote controller receiver display				
			Operation	Timer	Standby		
Activation of protective device	Faulty wiring connections of (ceiling) indoor unit panel	P09	☀	○	○		
	Indoor unit fan motor trouble	Indoor unit fan motor locked	P01	○	○	○	
		Indoor unit fan motor layer short		○	○	○	
		Contact failure in thermostat protector circuit		○	○	○	
	Activation of float switch wiring	Faulty drain pump	P10	○	○	○	
		Drainage failure		○	○	○	
		Contact failure of float switch wiring		○	○	○	
	Faulty drain pump	Faulty drain pump	P11	○	○	○	
		Drain pump locked		○	○	○	
	WHE water freezing alarm	WHE water freezing error		●	☀	☀	
	Indoor unit fan motor trouble	Indoor unit fan motor locked	P12	○	○	○	
		Faulty wiring connections of indoor unit fan motor		○	○	○	
	Valve error	Valve error	P13	○	○	○	
		Refrigerant circuit error		○	○	○	
	Wrong installation for refrigerant piping and wiring			○	○	○	
				○	○	○	
	O ₂ sensor error	O ₂ sensor detected	P14	○	○	○	
	Activation of protective device	Discharge temperature protective alarm	Compressor discharge temperature trouble	P03	○	○	○
		Activation of high pressure switch	Compressor discharge pressure trouble	P04	○	○	○
		Power supply failure	Open phase detected	P05	○	○	○
AC power supply trouble			○		○	○	
Insufficient gas		Insufficient gas level detected	P15	○	○	○	
Compressor overcurrent trouble			P16	☀	●	☀	
Fan motor locked/reversed airflow detected		Outdoor unit fan motor trouble	P22	○	○	○	
		Outdoor unit fan trouble		○	○	○	
WHE water pump interlock OFF alarm		WHE pump interlock error	P23	○	○	○	
Inverter compressor trouble			P29	○	○	○	
Group control trouble		Indoor unit in group control trouble	P31	○	○	○	
Activation of current control compressor's protective device		Primary (input) overcurrent detected	H01	○	○	○	
PAM trouble (overcurrent/over-voltage), Activation of compressor's protective device		PAM trouble	H02	○	○	○	
		Primary current control, Activation of compressor's protective device	Primary current CT sensor failure	H03	○	○	○
HIC trouble	HIC trouble DC voltage not detected	H31	○	○	○		
Thermistor fault	Indoor unit thermistor open/short	Indoor heat exchanger temperature sensor (E1) trouble	F01	○	○	○	
		Indoor heat exchanger temperature sensor (E2) trouble	F02	○	○	○	
		Indoor air temperature sensor (TA) trouble	F10	☀	☀	●	
	Outdoor unit thermistor open/short	Compressor discharge temperature sensor (TD) trouble	F04	○	○	○	
		Outdoor heat exchanger temperature sensor (C1) trouble	F06	○	○	○	
		Outdoor heat exchanger temperature sensor (C2) trouble	F07	○	○	○	
		Outdoor air temperature sensor (TO) trouble	F08	☀	☀	○	
Compressor suction temperature sensor (TS) trouble	F12	○	○	○			
Nonvolatile memory failure	Indoor unit EEPROM trouble	F29	☀	☀	●		
	Outdoor unit EEPROM trouble	F31	☀	☀	○		

5-2. Outdoor Unit Control Panel LED Display

(○ : ON ☀ : Blinking ● : OFF)

LED1	LED2	Display meaning
○	○	After the power is turned ON (and automatic address setting is not in progress), no communication with the indoor units in that system is possible.
(Both ON)		
●	○	After power is turned ON (and automatic address setting is not in progress), 1 or more indoor units are confirmed in that system; however, the number of indoor units does not match the number that was set.
(OFF)	(ON)	
●	●	Automatic address setting was completed successfully. (After the power is turned ON, the number of detected indoor units connected to that system matches the number that was set, and regular communications are occurring.)
(Both OFF)		
☀	☀	Automatic address setting is in progress.
(Blinking alternately)		
☀	☀	Alarm display LED 1 blinks M times, then LED 2 blinks N times. The cycle then repeats. M = 2: P alarm 3: H alarm 4: E alarm 5: F alarm 6: L alarm N = Alarm No. Example: LED 1 blinks 2 times, then LED 2 blinks 16 times. The cycle then repeats. Alarm is "P16."
(Blinking alternately)		
☀	○	PUMP DOWN is in progress.
LED 1 : Blinking LED 2 : ON		
☀ (0.8 / 0.3) *	●	P04 (High pressure trouble) Pre-trip display
LED 1 : Blinking LED 2 : OFF		
☀ (0.5 / 0.5)	●	Other Pre-trip display
LED 1 : Blinking LED 2 : OFF		

* Blinking (0.8 / 0.3) indicates that the lamp illuminates for 0.8 seconds, and then is OFF 0.3 seconds.

5-3. PAC System Alarm Codes

Alarms for outdoor units

Alarm Code	Alarm Meaning
E01	Remote Controller Reception Error
E02	Remote Controller Transmission Error
E03	Error in Indoor Unit Receiving Signal from Remote Controller (central)
E04	Error in Indoor Unit Receiving Signal from the Outdoor Unit
E05	Error in Indoor Unit Transmitting Signal to the Outdoor Unit
E06	Outdoor Unit Failed to Receive Serial Communication Signals from Indoor Unit
E08	Duplicate Indoor Unit Address Settings Error
E09	More Than One Remote Controller Set to Main Error
E12	Automatic Address Setting Start is Prohibited while Auto-address Setting in Progress.
E14	Main Unit duplication in Simultaneous-operation Multi Control (detected outdoor unit)
E15	Automatic Address Alarm (The total capacity of indoor units is too low.)
E16	Automatic Address Alarm (The total capacity of indoor units is too high or the total number of indoor units is too many.)
E18	Faulty Communication in Group Control Wiring
E20	Connection Problem of Indoor/Outdoor Units.
F04	Compressor Discharge Temperature Sensor (TD) Trouble
F06	Inlet Temperature Sensor (C1) in Heat Exchanger Trouble
F07	Intermediate Temperature Sensor (C2) in Heat Exchanger Trouble
F08	Outdoor Air Temperature Sensor (TO) Trouble
F12	Compressor Inlet Suction Temperature Sensor (TS) Trouble
F31	Outdoor Unit Nonvolatile Memory (EEPROM) Trouble
H01	Primary (input) Overcurrent Detected
H02	PAM Trouble
H03	Primary Current CT Sensor (current sensor) Failure
H31	HIC Trouble
L04	Outdoor Unit Address Duplication
L10	Outdoor Unit Capacity not Set or Invalid
L13	Indoor Unit Type Setting Error
L18	4-way Valve Operation Failure
P03	Compressor Discharge Temperature Trouble
P04	High Pressure Trouble
P05	AC Power Supply Trouble
P13	Alarm Valve Open
P14	O ₂ Sensor Detect
P15	Insufficient Gas Level Detected
P16	Compressor Overcurrent Trouble
P22	Outdoor Unit Fan Motor Trouble
P29	Lack of INV compressor wiring, INV compressor actuation failure (including locked), DCCT failure
P31	Group Control Error

Symptoms and Parts to Inspect

Remote controller alarm display	Alarm contents	Judgement conditions	Eliminating condition of alarm	Judgement and correction
P03	Abnormal discharge temperature error • Discharge temp. detected at or above the specified value	Stops when temp. exceeds 101 °C. Alarm output on 5 pre-trips	Recovery at restart	1. Check refrigerant cycle (gas leak). 2. Trouble with electronic expansion valve 3. Check discharge temperature sensor (TD).
P05	CT disconnected or AC power supply error DC voltage charge failure	The current value transmitted from the microcomputer on the outdoor unit control substrate is low. When no AC power input for more than 30 seconds to 5 minutes : Single alarm	Recovery at restart	1. Check outdoor unit control PCB. 2. Lack of reactor wire 3. Check power frequency.
P15	Insufficient gas level detected.	• Discharge temperature is 95 °C or higher. • Electronic expansion valve is at Step 480. When the above has continued for 1 minute. Indoor air sucking due to body thermostat max (E1 or E2) - TA ≤ 4 °C • Secondary current ≤ Current value of gas shortage determination	Recovery at restart	1. Check refrigerant cycle (gas leak). 2. Trouble with electronic expansion valve 3. Check outdoor unit valve opening.
L18	4-way valve operation failure • Judged after heating operating for 5 minutes consecutively.	The indoor unit heat exchanger temperature drops even though the compressor is switched on during the heating mode: To +20 °C ≤ C1 Pre-trip 1 time	Recovery at restart	1. Check 4-way valve. 2. Check 4-way valve wiring. 3. Check outdoor unit control PCB.
P04	High-pressure protection error	High pressure switched ON → OFF (Alarm is output when switch opened.) Pre-trip 4 times.	Recovery at restart	Overload operation of refrigerant cycle
P22	Outdoor unit fan motor trouble • Inverter protection circuit was activated, or lock was detected at outdoor unit fan motor.	Inverter stops after alarm is detected. Pre-trip 10 times	Recovery at restart	1. Position detection trouble. 2. Outdoor unit fan motor over-current Protection circuit is activated. • Check outdoor unit control PCB. • Refer to outdoor unit fan judgement methods.
P29	Lack of INV compressor wiring, INV compressor actuation failure, DCCT failure	Inverter stops after alarm is detected. Alarm is output when inverter stops (pre-trip) consecutively 10 times.	Recovery at restart	1. Stops immediately even when operations restarted. • Layer short on the compressor 2. Check HIC circuit. • Wiring trouble
H31	HIC trouble	Pre-trip consecutively 10 times	Temperature dropped	Heat sink and PCB (HIC) • Contact trouble

Check Prior to Auto Address Setting

* If an outdoor unit displays an alarm, conduct this process after diagnosing the problem.

1 Auto Address	1-1	Is the power of the indoor unit(s) and outdoor unit(s) on?	Yes	2-1
			No	Power on
2 Indoor/ outdoor control line	2-1	Has the wiring of the indoor/outdoor control line been completed? Is it all connected?	Yes	2-2
			No	Connect the wiring
	2-2	Has high voltage (over AC200V) been applied to the control line circuit? Has the fuse on the control PC board blown? (Check each board of the indoor unit(s) and outdoor unit(s).)	Yes	2-3
			No	3-1
2-3	The power line and indoor/outdoor control line are miswired. Turn off the power, check & correct the miswiring and then make connections of the indoor/outdoor control lines to the emergency side of all the control PC boards and controllers.			
3 Installation or setting related	3-1	Be sure that the indoor and outdoor units are connected with correct combination written in catalog.	Yes	3-2
			No	Correct the connection
	3-2	Is the indoor/outdoor control line connected to more than one outdoor unit? (Network wired?)	Yes	3-3
			No	3-6
	3-3	Is the Terminal resistor select switch (CN-TERMINAL) on the outdoor control PC board set to just one unit?	Yes	3-4
			No	Correct the setting
	3-4	Are other outdoor units using a duplicate setting?	Yes	3-5
			No	3-6
3-5	When units are networked, first set the system address for each outdoor unit in the order 1-2-3 and then run auto address setting.			
3-6	Run the auto address setting.			

E04 Error in Indoor Unit Receiving Signal from the Outdoor unit

1. Error Detection Method

When there is no communication within a 3-minute period from the outdoor unit. Or, judged an error when no reply comes from the outdoor unit.

- The outdoor unit is not turned on.
- When the network of indoor/outdoor operation line was wired, the (SHORT) setting of the terminal resistor switch on the outdoor control PC board was set on multiple units (four or more).
- When the power was turned on after auto address setting was completed, the number of indoor units had been changed.
- Forgot to turn on the indoor unit.
- The CHK pin and/or TEST pin on the indoor unit's control PC board are shorted.
- Forgot to install the nonvolatile memory (EEPROM) when replacing the indoor unit control PC board.
- Mistakenly set the indoor unit address to Not Set in the remote control's detailed settings mode.
- When indoor unit addresses are duplicated.
- There is a short, open, wrong contact or grounding of the indoor/outdoor operation line.
- There is an error in the receiving circuit on the signal output PC board (optional control PC board).
- Malfunctions of the outdoor unit
- High voltage was applied (over AC200V) in the indoor/outdoor operations line circuit.
- The thermistor inside the indoor unit is grounded.

2. Error Diagnosis

1 Power Source	1-1	Is/was the power to the outdoor unit cut off?	Yes	After turning the power on, wait three minutes
			No	1-2
	1-2	Is the indoor unit powered off?	Yes	Power on
			No	2-1
2 Indoor/outdoor control line	2-1	Is the indoor/outdoor operation line shorted, opened, grounded or has a wrong contact?	Yes	Correct the wiring
			No	2-2
	2-2	When the network of indoor/outdoor operation line was wired, was the (SHORT) setting of the terminal resistor switch (CN-TERMINAL) on the outdoor control PC board set on multiple units (four or more)?	Yes	Normally the (SHORT) setting is just one unit.
			No	2-3
2-3	Was a high voltage (over AC200V) applied in the indoor/outdoor operations line circuit?	Yes	3-2	
		No	3-1	
3 No. of Indoor Units	3-1	Was the number of indoor units increased or decreased after auto address setting was complete?	Yes	3-2
			No	3-3
	3-2	Conduct checks prior to auto address setting.		
	3-3	Check the indoor unit addresses from the remote control's detailed settings mode. Is it Not Set (99), or is the indoor unit's address duplicated?	Yes	3-2
			No	4-1
4 Indoor unit control PC board	4-1	Are the CHK pin and/or TEST pin on the indoor unit control PC board short-circuited?	Yes	Remove the short
			No	4-2
	4-2	Is the wireless remote controller connected to on the indoor unit's control PC board?	Yes	4-3
			No	4-5
	4-3	Disconnect the connector mentioned above on the control PC board of the indoor unit control PC board, and see whether the E04 goes off after several minutes. (When doing so, if two remote controllers are being used and the wireless remote controller is the main remote controller, set the other remote controller as the main.)	Yes	4-4
			No	4-5
	4-4	Replace wireless remote control parts including wiring.		
4-5	Is the LED on the indoor unit control PC board blinking?	Yes	4-6	
		No	4-7	
4-6	The nonvolatile memory (EEPROM) on the indoor unit's control PC board is either not installed, improperly installed or the nonvolatile memory is faulty. Correct this or after replacing the nonvolatile memory, write model data to it in the remote control detailed settings mode.			
4-7	Are all the remote controllers of the other indoor units connected to that outdoor unit displaying E04?	Yes	Replace the outdoor unit control board	
		No	Replace the indoor unit control board	

E06 Outdoor Unit Failed to Receive Serial Communication Signals from Indoor Unit

(When indoor unit(s) are connected)

1. Error Detection Method

It is judged an error when there is no transmission (reply) from the indoor unit to the outdoor unit for a period of three minutes.

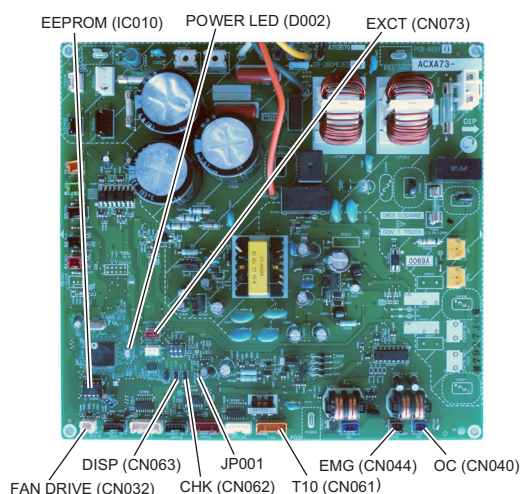
- The indoor unit is not turned on.
- The DISP pin of the indoor unit is shorted.
- There is a short, open, wrong contact or grounding of the indoor/outdoor operation line.
- The signal output control PC board (optional control PC board) inside the indoor unit has failed.
- The thermistor inside the indoor unit is grounded.

2. Error Diagnosis

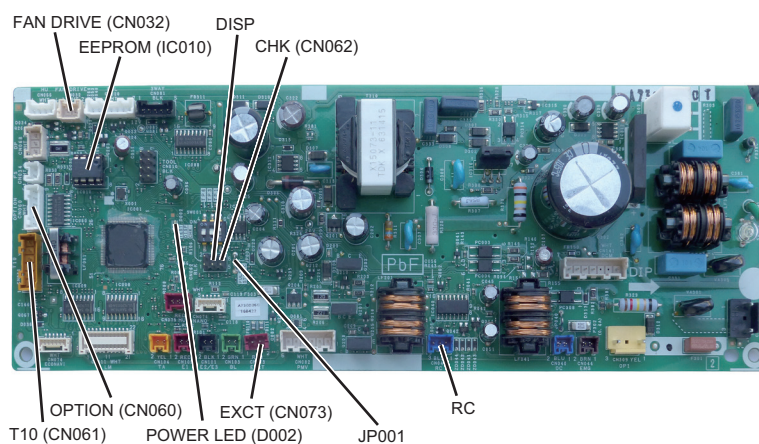
1 Indoor unit power	1-1	Is the indoor unit powered off?	Yes	Power on
			No	2-1
2 Indoor/outdoor operation line	2-1	Is the indoor/outdoor operation line shorted, opened, grounded or has a wrong contact?	Yes	Correct the wiring
			No	3-1
3 Indoor units control PC board	3-1	Are the DISP pin and CHK pin on the indoor unit control PC board short-circuited?	Yes	Remove the short
			No	3-2
	3-2	Is the wireless remote controller connected to on the indoor unit's control PC board?	Yes	3-3
			No	3-5
	3-3	Disconnect the connector mentioned above on the control PC board of the indoor unit control PC board, and see whether the E06 goes off after several minutes. (When doing so, if two remote controllers are being used and the wireless remote controller is the main remote controller, set the other remote controller as the main.)	Yes	3-4
			No	3-5
3-4	Replace wireless remote control parts including wiring.			
3-5	Indoor unit control PC board failure → Replace board.			

- For information on the procedures for replacing the indoor unit's control board, refer to the manual that is packaged with the indoor unit control PCB.

Indoor Unit Control PCB (ACXA73-3081*) : S-200PE3E5B, S-250PE3E5B



Indoor Unit Control PCB (ACXA73-2553*) : S-50PU2E5B, S-60PU2E5B, S-71PU2E5B, S-100PU2E5B, S-125PU2E5B



E15 Automatic Address Alarm (The total capacity of indoor units is too low.)

1. Error Detection Method

Connecting indoor unit

It is judged an error the total capacity of indoor units replied by communication is lower than that of outdoor unit.

- The total capacity of indoor units is lower than that of outdoor unit.
- Some indoor unit(s) are connected but power is not turned on.
- The CHK pin (CN062/CN071) and/or TEST pin (CN064) of the indoor unit is shorted when its power is turned on.
- High voltage was applied (over AC200V) in the indoor/outdoor operations line circuit.

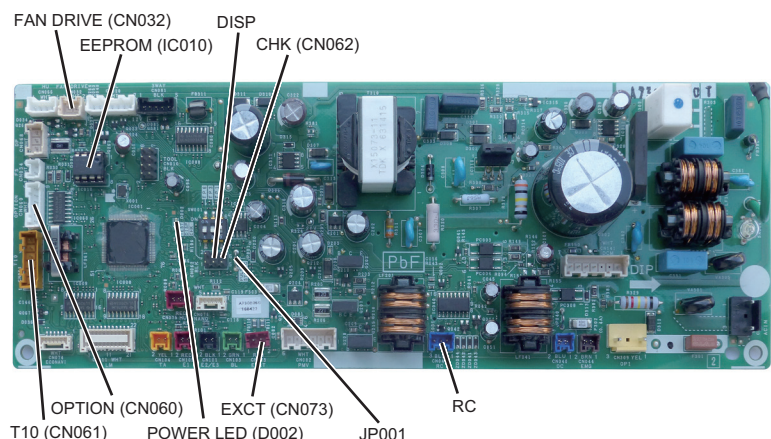
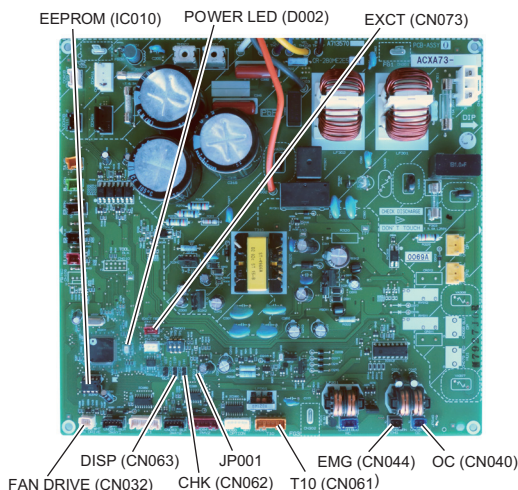
2. Error Diagnosis

1 Power Source	1-1	Is the indoor unit powered off?	Yes	Power on
			No	2-1
2 Indoor/outdoor control line	2-1	Is the indoor/outdoor control line opened or shorted?	Yes	Correct the wiring
			No	2-2
	2-2	Was a high voltage (over AC200V) applied in the indoor/outdoor operations line circuit?	Yes	3-2
			No	3-1
3 No. of Indoor Units	3-1	Was the number of indoor units changed after auto address setting finished?	Yes	3-2
	3-2	Conduct checks prior to auto address setting.	No	4-1
4 Indoor unit control PC board	4-1	Are the CHK pin and TEST pin on the indoor unit control board short-circuited?	Yes	Remove the short
			No	4-2
	4-2	Is the wireless remote controller connected to on the indoor unit's control PC board?	Yes	4-3
			No	4-5
	4-3	Disconnect the connector mentioned above on the control PC board of the indoor unit control PC board and see whether the E15 goes off after several minutes. (When doing so, if two remote controllers are being used and the wireless remote controller is the main remote controller, set the other remote controller as the main.)	Yes	4-4
			No	4-5
4-4	Replace wireless remote control parts including wiring.			
4-5	Is the LED blinking on the indoor unit's control PC board?	Yes	4-6	
		No	5-1	
4-6	The nonvolatile memory (EEPROM) on the indoor unit's control board is either not installed, improperly installed or the nonvolatile memory is faulty. Correct this or after replacing the nonvolatile memory, write model data to it in the remote control detailed settings mode.			
5 Outdoor unit control PC board	5-1	Check all items under the section "Check Prior to Auto Address Setting".		

- For information on the procedures for replacing the nonvolatile memory (EEPROM) of the indoor unit, refer to the manual that is packaged with the indoor unit service board.
- For information on the remote control's detailed settings, refer to the Reference Materials.

Indoor Unit Control PCB (ACXA73-3081*) : S-200PE3E5B, S-250PE3E5B

Indoor Unit Control PCB (ACXA73-2553*) : S-50PU2E5B, S-60PU2E5B, S-71PU2E5B, S-100PU2E5B, S-125PU2E5B



E16 Automatic Address Alarm (The total capacity of indoor units is too high.)

1. Error Detection Method

It is judged an error the total capacity of indoor units is too high or the total number of indoor units is too many.

- The total capacity of indoor units is too high.
- The total number of indoor units is too many.

2. Error Diagnosis

1 Auto Address	1-1	Check all items under the section "Check Prior to Auto Address Setting".
----------------	-----	--

F04 Compressor Discharge Temperature Sensor (TD) Trouble

1. Error Detection Method

It is judged an error based on the criteria listed below.

- Open circuit or Short circuit

2. Error Diagnosis

1 Sensor	1-1	Sensor connector is connected to PC board properly.	Yes	1-2
			No	Reconnect and check
	1-2	Sensor is correctly installed at holder side.	Yes	Replace sensor
			No	Correct and see what happens. 1-3
	1-3	Abnormal temperature exists even after replacing sensor.	Yes	2-1
			No	See what happens.
2 PC board	2-1	Resistance between connector pins on PC board is less than 1 k ohm	Yes	Replace PC board
			No	2-2
	2-2	Abnormal temperature exists even after replacing PC board.	Yes	3-1
			No	See what happens.
3 Operating status	3-1	Peripheral temperature of outdoor unit is over 46°C.	Yes	Correct
			No	3-2
	3-2	Tends to have insufficient refrigerant charge in the system.	Yes	Adjust the amount of refrigerant
			No	3-3
	3-3	Check noise.		

F06 Inlet Temperature Sensor (C1) in Heat Exchanger Trouble

1. Error Detection Method

- In case of open or short

2. Error Diagnosis

1 Sensor Trouble	1-1	Is the connector properly connected to PCB?	Yes	1-2
			No	Reconnect & check
	1-2	Is the resistor between the sockets infinity or 0 ohm?	Yes	Replace sensor.
			No	2-1
2 Control PCB Failure	2-1	Outdoor unit control PCB failure Replace PCB with a new one.		

F07 Intermediate Temperature Sensor (C2) in Heat Exchanger Trouble

1. Error Detection Method

It is judged an error when open circuit or short circuit.

2. Error Diagnosis

1 Sensor	1-1	Sensor connector is connected to PC board properly.	Yes	1-2
			No	Reconnect and check
	1-2	Resistance between sockets is infinity or 0 ohm.	Yes	Replace sensor
			No	2-1
2 PC board	2-1	Replace PC board because of outdoor control PC board failure.		

F08 Outdoor Air Temperature Sensor (TO) Trouble

1. Error Detection Method

It is judged an error when open circuit or short circuit.

2. Error Diagnosis

1 Sensor	1-1	Sensor connector is connected to PC board properly.	Yes	1-2
			No	Reconnect and check
	1-2	Resistance between sockets is infinity or 0 ohm.	Yes	Replace sensor
			No	2-1
2 PC board	2-1	Replace PC board because of outdoor control PC board failure.		

F12 Compressor inlet Suction Temperature Sensor (TS) Trouble

1. Error Detection Method

It is judged an error when open circuit or short circuit.

2. Error Diagnosis

1 Sensor	1-1	Sensor connector is connected to PC board properly.	Yes	1-2
			No	Reconnect and check
	1-2	Resistance between sockets is infinity or 0 ohm.	Yes	Replace sensor
			No	2-1
2 Outdoor control PC board	2-1	Replace PC board because of outdoor control PC board failure.		

F31 Outdoor Unit Nonvolatile Memory (EEPROM) Trouble

1. Error Detection Method

It is judged an error based on the criteria listed below.

- When power initially turned ON for the first time, nonvolatile memory (EEPROM) is not installed.
- Read values after writing onto nonvolatile memory (EEPROM) is inconsistent.

2. Error Diagnosis

1 PC board	1-1	Does EEPROM exist on the control PC board?	Yes	1-2
			No	Install EEPROM
	1-2	Is EEPROM installed properly? (Check: Bent IC pin or incorrect installation, etc.)	Yes	1-3
			No	Correct
	1-3	Incorrect EEPROM Replace with correct EEPROM.		

H01 Primary (input) Overcurrent Detected

1. Error Detection Method

- Primary current effective value detected overcurrent (trip current value).

Trip current value HP = horse power

3-phase model	8 HP	10 HP
Heating	16.5A	21.5A
Cooling	15.5A	18.5A

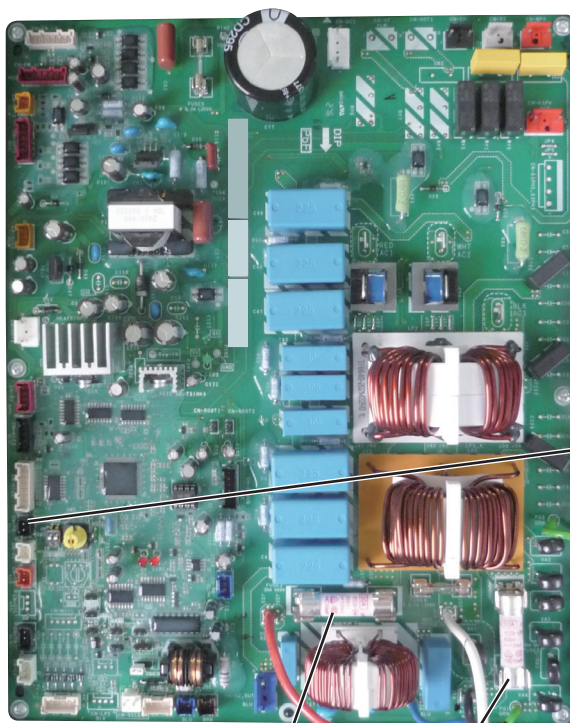
2. Error Diagnosis

1 Power supply*	1-1	Not satisfied with $\pm 10\%$ rated supply voltage	Yes	Check power supply
			No	1-2
	1-2	Extreme voltage fluctuations	Yes	Check power supply
			No	1-3
	1-3	Extreme distortion of voltage waveform	Yes	Check power supply
			No	1-4
	1-4	Instantaneous blackout may sometimes occur.	Yes	Check power supply
			No	2-1
2 PC board wiring	2-1	Has FUSE2 / FUSE3 blown? Check the electrical conduction with tester.	Yes	2-3
			No	2-2
	2-2	Loose electrical wire connection	Yes	Correct wiring
			No	2-3
	2-3	Replace CR board.		

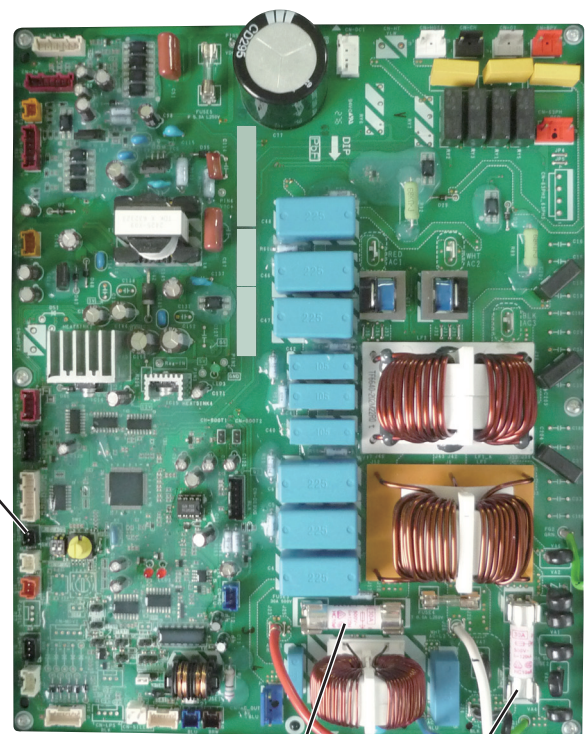
* Check not only in the outdoor unit stop mode but in the drive mode.

ACXA73-3030* (U-200PZH2E8)
(for 3-phase outdoor Unit PCB)

ACXA73-3028* (U-250PZH2E8)
(for 3-phase outdoor Unit PCB)



FUSE3 FUSE2



FUSE3 FUSE2

CN-TD

H03 Primary Current CT Sensor (current sensor) Failure

1. Error Detection Method

It is judged an error based on the criteria listed below.

- If 18A or greater is detected when the compressor is stopped (alarm triggered even if the connector is unplugged).
- If no current is detected even though a compressor is running.

2. Error Diagnosis

1 Check the control PC board	1-1	Turn the power on again and run the outdoor unit. Is alarm occurred after operation?	Yes	Replace CR board.
			No	See what happens.

H05 Sensor Failure, Compressor Discharge Temperature Sensor (TD) Disconnected

1. Error Detection Method

- (In case of outdoor temperature over 5°C) For 10 minutes since started, variation of discharge temperature is always detected within 2°C comparing with the temperature just before starting.
- (In case of outdoor temperature less than 5°C) For 30 minutes since started, variation of discharge temperature is always detected within 2°C comparing with the temperature just before starting.

1 Sensor Trouble	1-1	Is the sensor properly installed at the holder side?	Yes	1-2
	1-2		No	Reinstall correctly.
		Replace the sensor with a new one.		

H31 HIC Trouble

1. Error Detection Method

It is judged an error if the computer detects an error signal from the HIC.

An error signal is issued by the HIC if abnormal heat occurs inside the HIC or if there is an overcurrent.

However, it is judged an error in the same way if the signal line from the HIC is not connected properly or opened.

- HIC overcurrent due to HIC fault
- HIC abnormal heat caused by defective HIC or HIC radiation error
- Signal line is not connected properly or opened between the HIC and the outdoor CR board.

2. Error Diagnosis

1 Wiring between HIC & outdoor control PC board	1-1	The wiring (power cord and signal line) between the HIC and the outdoor CR board is connected properly.	Yes	1-2
			No	Correct wiring (connector)
	1-2	Everything is normal in the wiring (power cord & signal line) between the HIC and the outdoor CR board. Check the wiring one by one with a tester if there is opened and grounding.	Yes	3-1 : Single-phase model 2-1 : 3-phase model
			No	Replace wiring
2 Check the outdoor unit CR PC board	2-1	The connector CN-RY on the CR PC board is connected properly (locked). (3-phase only)	Yes	3-1
			No	Correct wiring (connector)
3 HIC poor radiation	3-1	The heat dissipating surface on the back of the HIC is in good contact with the heat sink (heat dissipating fins) of the electrical box. Check for looseness in the fastening screws and the condition of the heat-conducting putty.	Yes	3-2
			No	Tighten screw(s), add putty
	3-2	A good flow of cooling air passes through the heat sink (heat dissipating fins) of the electrical box. Check for debris blocking the fins.	Yes	4-1
			No	Remove foreign matter
4 HIC overcurrent	4-1	The results of the pass/fail tests for the following HIC board IPM show it to be outside the range of the resistance of a conforming part.	Yes	Replace the HIC PC board
			No	4-2
	4-2	The inverter compressor was stopped/started more than 10 times and it triggered H31 at a high rate. If alarm code P16 occurs at times, refer to the alarm code P16.	Yes	Replace the HIC PC board
			No	Refer to alarm code P16

• HIC board IPM Pass/Fail Tests

- Measure with an analog tester. (Set to the k ohm range)
- Measure the board by itself. (Remove wires connected from other parts.)
- Measure using IPM terminals.

★ Conforming part resistance value (measure with an analog tester)

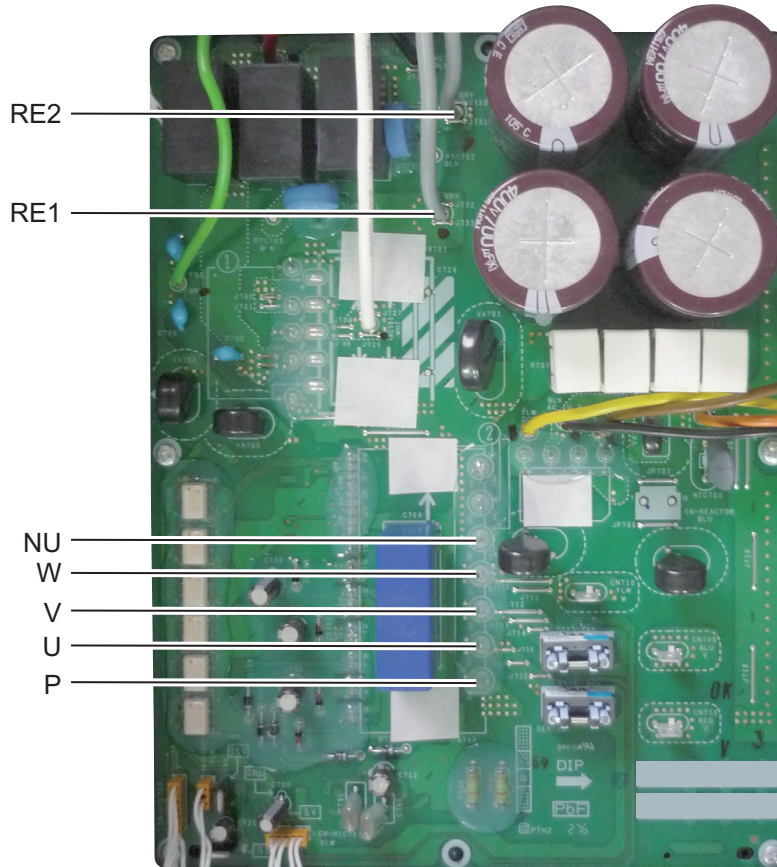
Tester terminals								
+	P				NU			
-	U	V	W	NU	U	V	W	P
Resistance value (ohm)	1 k to 5 k	1 k to 5 k	1 k to 5 k	5 k to 10 k	100 k to ∞	100 k to ∞	100 k to ∞	100 k to ∞
Tester terminals								
-	P				NU			
+	U	V	W		U	V	W	
Resistance value (ohm)	100 k to ∞	100 k to ∞	100 k to ∞		1 k to 5 k	1 k to 5 k	1 k to 5 k	

- Excepting the parts of "100 k to ∞", it is acceptable if a small resistance value appears as a reference value unless the value is "0 = short-circuit".

Tester terminals								
+	HIC+				HIC-			
-	U	V	W	HIC-	U	V	W	HIC+
Resistance value (ohm)	1 k to 10 k	1 k to 10 k	1 k to 10 k	5 k to 20 k	20 k to ∞	20 k to ∞	20 k to ∞	20 k to ∞
Tester terminals								
-	HIC+				HIC-			
+	U	V	W		U	V	W	
Resistance value (ohm)	20 k to ∞	20 k to ∞	20 k to ∞		1 k to 10 k	1 k to 10 k	1 k to 10 k	

- Excepting the parts of “ 20 k to ∞ ”, it is acceptable if a small resistance value appears as a reference value unless the value is “0 = short-circuit”.

■ Outdoor Unit Control HIC PCB
ACXA73-3104* : (U-200PZH2E8, U-250PZH2E8)
(3-phase outdoor unit HIC PC board)



L04 Outdoor Unit Address Duplication

1. Error Detection Method

It is judged an error when the identical self-address communication on the indoor and outdoor wirings is received over 5 times within 3 minutes.

2. Error Diagnosis

1 System address	1-1	Are other outdoor units using a duplicate setting?	Yes	2-1
			No	2-2
2 Installation or setting related	2-1	When units are networked, first set the system address for each outdoor unit in the order 1-2-3 and then run auto address setting.		
	2-2	Run the auto address setting.		

L10 Outdoor Unit Capacity not Set or Invalid

1. Error Detection Method

It is judged an error when outdoor unit capacity not yet setup or systematically unauthorized setting.

2. Error Diagnosis

1 Check the control PC board	1-1	Was EEPROM replaced when PC board was replaced?	Yes	2-1
			No	Replace EEPROM
2 Installation or setting related	2-1	Set an applicable capacity value on the item code 81 display of maintenance remote controller.		

- Check : Connect the outdoor maintenance remote controller and check whether item code 81 outdoor capacity value shows "0" or unauthorized capacity is set on the detailed settings mode display of the outdoor EEPROM. If the capacity value of the item code 81 with the outdoor maintenance remote controller is incorrect, recorrect and set it again.

* After setting the capacity value, be sure to reset the power supply switches of both indoor and outdoor units.

L13 Indoor Unit Type Setting Error

1. Error Detection method

- Discordance model(s) between outdoor and indoor units are detected.

1 Discordance Unit	1-1	Are models for outdoor and indoor units matched respectively? (Ex: Are multiple indoor units connected to commercial outdoor units?)	Yes	2-1
			No	Replace indoor units.
2 Installation Failure	2-1	Check the indoor unit's motor valve with the remote control detailed settings mode (2C code) and commercial indoor unit is set to "2" and multiple indoor unit is "0".	Yes	3-1
			No	Change installation.
3 Operating Wires for Indoor & Outdoor Units	3-1	Check whether or not indoor and outdoor unit operating wires are short circuit, disconnection, loose connection or earth fault.		

L18 4-way Valve Operation Failure

1. Error Detection Method

It is judged an error when during heating operation (Comp. ON), the highest detected temperature at an outdoor unit heat exchanger (C1) was 20°C or more above the outdoor air temperature (Air Temp.) continuously for 5 minutes or longer.

2. Error Diagnosis

1 PC board wiring	1-1	Is the connector wired from the 4-way valve plugged in the CN-HOT1 or CN-HOT2 connector on the HIC PC board properly?	Yes	1-2
			No	Correct connector
	1-2	Has the 4-way valve wiring become opened?	Yes	Correct wiring
			No	1-3
	1-3	Is the wire from the coil for controlling the 4-way valve firmly connected to the 4-way valve?	Yes	2-1
			No	Correct connector
2 4-way valve	2-1	During heating mode (Comp. ON), insert and remove the connector wired from the 4-way valve into or from CN-HOT1 or CN-HOT2 connector on the HIC PC board. At the same time, does the ON & OFF sounds occur from the 4-way valve?	Yes	2-2
			No	Replace HIC PC board
	2-2	During heating mode (Comp. ON), does the alarm code L18 reproduce for 5 minutes or longer after insertion and removal of CN-HOT1 or CN-HOT2 connector wired from the 4-way valve connector on the HIC PC board?	Yes	2-3
			No	See what happens
2-3	The parts inside the 4-way valve might have fixed at the cooling side. Replace the 4-way valve			

P03 Compressor Discharge Temperature Trouble

1. Error Detection Method

- When the discharge temperature is over 106°C.

2. Error Diagnosis

1 Adjustment to refrigerant charge	1-1	Not additional refrigerant charged	Yes	Additional refrigerant charge
			No	2-2
	1-2	Tends to have insufficient refrigerant charge in the system.	Yes	Adjust the refrigerant amount
			No	Replace CR board
2 Blockage in refrigerant circuit	2-1	Service valve inside the outdoor unit closed	Yes	Open service valve
			No	2-2
	2-2	Are the tubes clogged?	Yes	Avoid clogging
			No	2-3
	2-3	Is the outdoor unit's electronic control valve operating correctly? (Check for debris clogging the electronic control valve, a problem with the electrical coil and/or the control PC board.)	Yes	2-4
			No	Replace the electronic control valve
2-4	Is it observable difference in status of the dew or frost between the strainer's primary and secondary sides?	Yes	Replace the strainer	
		No	Replace CR board	

P04 High Pressure Trouble

1. Error Detection Method

It is judged an error if the internal circuit of the high pressure switch is dead.
The electronic circuitry of the high pressure switch is cut off if the pressure at the pressure sensor port of the high pressure switch reaches 3.80 MPa. Once it is cut off, it remains cut off until the pressure drops to 3.15 MPa.

- The high pressure switch is malfunctioning.
- Service valve inside the outdoor unit closed
- There is a short air circuit through the outdoor unit's heat exchanger. (when cooling)
- The outdoor unit's fan is broken. (when cooling)
- The outdoor unit's heat exchanger is clogged. (when cooling)
- There is a short air circuit at the indoor unit. (when heating)
- The filter of the indoor unit is clogged. (when heating)
- The fan of the indoor unit is broken or the fan motor is malfunctioning. (when heating)
- The refrigerant circuit is closed and the high pressure is increasing abnormally high. (solenoid valve or expansion valve not activated, a stuck check valve, etc.)
- Refrigerant overcharged.
- Nitrogen or air contaminated in the refrigerant system

2. Error Diagnosis

1 High pressure switch	1-1	The socket of the high pressure switch is securely inserted in the PC board. The wiring is not opened.	Yes	1-2
			No	Correct connection and/or wiring
	1-2	Even if parts near the high pressure switch are shaken quite a lot, the high pressure cutoff will be activated. Even if the covering is in good condition, in several cases vibration has caused wiring inside to open.	Yes	Replace the high pressure switch (wiring)
			No	2-1
2 Service valve	2-1	Service valve inside the outdoor unit closed	Yes	Open the service valve
			No	2-2
	2-2	There is an extreme difference in temperature in/out of the service valve.	Yes	2-3
			No	3-1
	2-3	Check the flare connection, someone may have forgotten to remove the bonnet. If there is a problem within the service valve, replace the valve.		
3 Problem around the heat exchanger	3-1	While cooling is operating an alarm is occurred.	Yes	3-2
			No	3-5
	3-2	The intake temperature (ambient temperature) of the outdoor unit's heat exchanger is above 46°C.	Yes	Prevent air short circuit
			No	3-3
	3-3	The outdoor unit's heat exchanger is clogged.	Yes	Clean the heat exchanger
			No	3-4
	3-4	Check whether the outdoor unit fan is normal or if the sockets are firmly pressed onto the plugs on the outdoor PC board, as well as if any wiring is opened. Are these checking finished without fail?	Yes	4-1
			No	Replace the outdoor unit fan. Correct connection and/or wiring
3-5	While heating is operating an alarm is occurred.	Yes	3-6	
		No	4-1	

3 Problem around the heat exchanger	3-6	The intake temperature (ambient temperature) of the indoor unit is above 36°C.	Yes	Prevent air short circuit
			No	3-7
	3-7	The filter of the indoor unit is clogged.	Yes	Clean the filter
			No	3-8
	3-8	The fan of the indoor unit is broken or the fan motor is faulty.	Yes	Replace the indoor fan (motor)
			No	4-1
4 Blockage in the refrigerant circuit	4-1	Is the outdoor unit's electronic control valve operating correctly? (Check for debris clogging the electronic control valve, a problem with the electrical coil and/or the control PC board.)	Yes	4-3
			No	Repair the electronic control valve of the outdoor unit
	4-2	The indoor unit's expansion valve is operating correctly. (check for debris clogging the valve, a problem with the electrical coil and/or the control PC board)	Yes	4-3
			No	Repair the expansion valve of the indoor unit
	4-3	If an alarm is occurred with the high pressure below 3.80 MPa, with the pressure measured as displayed by the manifold gauge, check the check valve in the compressor discharge line. Are these checking finished without fail?	Yes	4-4
			No	Replace the check valve in the compressor discharge line
	4-4	The electronic control valve is faulty. In systems where the solenoid valve kits and the ice thermal storage tank are connected, check these solenoid valves.	Yes	Replace the electronic control valve and/or solenoid valve.
			No	5-1
5 Overcharging	5-1	Error occurs when the system is operating in cooling mode.	Yes	5-3
			No	5-2
	5-2	Error occurs when the system is operating in heating mode.	Yes	5-4
			No	5-5
	5-3	An alarm is occurred with the high pressure at 3.80 MPa, with the pressure measured either as displayed by the monitoring software or with a manifold gauge, at which time the temperature of liquid in the outdoor unit's heat exchanger is detected to be at the temperature of the outside air.	Yes	5-5
			No	Contact the service representative
	5-4	An alarm is occurred with the high pressure at 3.80 MPa, with the pressure measured either as displayed by the monitoring software or with a manifold gauge, at which time the temperature of liquid in the indoor heat exchanger is detected to be at room temperature (intake temperature).	Yes	5-5
			No	Contact the service representative
5-5	The system may be overcharged. Check how much refrigerant was added during installation. When a system is inspected for airtightness, it is seldom that enough nitrogen has been expelled, so some remains in the circuit. In this case, it is necessary to collect the refrigerant and then recharge the system.			

P05 AC Power Supply Trouble

1. Error Detection Method

- Instantaneous blackout
- Zero-cross (waveform input of power supply) error
- DC voltage charge failure

2. Error Diagnosis

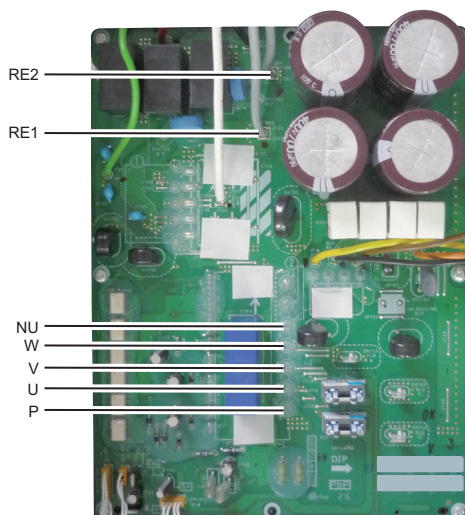
Note : The work involved in diagnosing each of the items is extremely dangerous, so turn the power off at the breaker before performing the tests.

1 Check the power supply & the wiring	1-1	Is the voltage on each of the terminal boards within $\pm 10\%$ of the rated voltage?	Yes	1-4 : Single-phase model 1-2 : 3-phase model
			No	Check for open circuit and the voltage at the breaker. if a problem is found, fix it and check again.
	1-2	Power wiring N-phase is connected.	Yes	Correct wiring
			No	1-3
1-3	Power wiring L2 and N are reverse connected. (3-phase only)	Yes	Correct wiring	
		No	1-4	
1-4	Turn the power back on and check again. Is the alarm triggered again?	Yes	3-1 : Single-phase model 2-1 : 3-phase model	
		No	4-1	
2 Check the outdoor unit CR PC board	2-1	The connector CN-RY on the outdoor CR PC board is connected properly (locked). (3-phase only)	Yes	3-1
			No	Correct wiring (connector)
3 Check the outdoor unit HIC PC board	3-1	Are the wires (RE1, RE2) from the reactor firmly installed?	Yes	3-2
			No	Correct wiring
	3-2	Turn the power back on and check again. Is the alarm triggered again?	Yes	Replace the outdoor unit HIC PC board.
			No	4-1
4 Final check	4-1	There may be a instantaneous blackout failure. If there is nothing abnormal, see what happens.		

■ Outdoor Unit Control HIC PCB

ACXA73-3104* : (U-200PZH2E8, U-250PZH2E8)

(3-phase outdoor unit HIC PC board)



P13 Alarm Valve Open

1. Error Detection Method

Detection is performed only in the test run. When once detected or the test run finished without any error, the second detection will not be done.

In case of forgetting to open a valve, P04 (high-pressure switch operational alarm) is occasionally preceded due to the following conditions.

- The status of small temperature change of the operating indoor unit continues for the first 7 minutes since the cooling test run has started.

2. Error Diagnosis

1 Service valve	1-1	Service valve inside the outdoor unit closed	Yes	Open the service valve
			No	2-1
2 Adjustment to refrigerant change	2-1	Not additional refrigerant charged	Yes	Additional refrigerant charge
			No	3-1
3 Blockage in refrigerant circuit	3-1	Are the tubes clogged?	Yes	Avoid clogging
			No	3-2
	3-2	Is the outdoor unit's electronic control valve operating correctly? (Check for debris clogging the electronic control valve, a problem with the electrical coil and/or the control PC board.)	Yes	3-3
			No	Replace the electronic control valve
3-3	As the second detection is not done, restart and see what happens if there is no error.			

P14 O₂ Sensor Detect

1. Error Detection Method

- It is judged an error whenever the outdoor unit receives the signal "O₂ Alarm Occurred" from the indoor unit.
- With the indoor unit's EEPROM setting (item code 0B) set to 0001, the EXCT input was shorted.

2. Error Diagnosis

1 System configuration	1-1	Is an O ₂ sensor being used?	Yes	3-1
			No	2-1
2 Indoor unit's EEPROM setting	2-1	Is the indoor EEPROM setting, item code 0B, on the indoor unit's control PC board set to 0001?	Yes	After correcting the setting, 3-1
			No	4-1
3 Indoor EXCT wiring	3-1	Is the indoor EXCT socket (wire) shorted?	Yes	Correct wiring
			No	4-1
4 Indoor unit's control PC board	4-1	Is the alarm triggered if the indoor EXCT socket (wire) is disconnected, and the power is reset?	Yes	4-3
			No	4-2
	4-2	Since there is no error, see what happens.		
4-3	Indoor unit control PC board error → replace PC board.			

P15 Insufficient Gas Level Detected

1. Abnormal Detection Method

Alarm occurs in the following cases:

- Compressor's current value shows lower than a certain value.
- Compressor's discharge temperature exceeds 95°C.
- Electronic expansion valve is fully opened.
- The difference between indoor unit heat exchanger temperature and intake temperature is less than 4K.

2. Error Diagnosis

1 Adjustment of refrigerant amount	1-1	Insufficient gas level (Check whether or not pressure level is normal.)	Yes	Recharge with additional refrigerant.
			No	1-2
1 Adjustment of refrigerant amount	1-2	Check leakage of refrigeration (leak test)	Yes	Replace leaking part with a new one.
			No	See what happens.

P16 Compressor Overcurrent Trouble

1. Meaning of Alarm

- Secondary current effective value detected the overcurrent (trip current value).
3-phase model (8, 10HP) : Trip current = 25.0 A
- Secondary current instantly detected overcurrent (trip current value).
3-phase model (8, 10HP) : Trip current = 38.0 A_{peak}

2. Check of content

0 Multiple factors	0-1	Replaced the compressor (added oil, if it was necessary) but it occurred again immediately.	Yes	7-1
			No	-
	0-2	Replaced the board, but it occurred again immediately.	Yes	Replace compressor along with adding oil, then recheck from 1-1
			No	-
1 Power Source	1-1	Power cord connections are loose.	Yes	Correct the wiring
			No	1-2
	1-2	Rated power voltage is not within $\pm 10\%$.	Yes	Test the power supply
			No	1-3
	1-3	Extreme fluctuations in voltage.	Yes	Test the power supply
			No	1-4
	1-4	An open phase state is observed.	Yes	Test the power supply
			No	2-1
2 Board wiring	2-1	Disconnected parts, miswiring and/or poor connections (loose) are observed in the connections on the CR board and/or in the connections of components that are connected by wiring from the CR board.	Yes	Correct
			No	2-2
	2-2	Disconnected parts, miswiring and/or poor connections (loose) are observed in the connections of outdoor board(s) that are connected by wiring from the CR board.	Yes	Correct
			No	2-3
	2-3	Disconnected parts, miswiring and/or poor connections (loose) are observed in the connections of outdoor board(s) that are connected by wiring from the HIC board.	Yes	Correct
			No	2-4
	2-4	Disconnected parts, miswiring and/or poor connections (loose) are observed in the connections of HIC boards connected by wiring from the CR board.	Yes	Correct
			No	2-5
	2-5	Disconnected parts, miswiring and/or poor connections (loose) are observed in the connections of HIC board(s) that are connected by wiring from the outdoor board.	Yes	Correct
			No	2-6
	2-6	Disconnected parts, miswiring and/or poor connections (loose) are observed in the connections of HIC board(s) that are connected by wiring to a compressor.	Yes	Correct
			No	3-1
3 Compressor wiring	3-1	Disconnections and/or miswiring are observed in the connecting location of the compressor terminals.	Yes	Correct
			No	3-2
	3-2	Conditions such as burned terminal covers and/or discolored terminals are observed in the connecting location of the compressor terminals.	Yes	Eliminate looseness by changing the terminals, or crimping the terminals again.
			No	4-1

4 Check the situation	4-1	Outdoor air intake temperature is high.	Yes	Take measures
			No	4-2
	4-2	May be caused by poor outdoor unit air flow (dirty or clogged heat exchanger, blocked discharge port, etc.)	Yes	Correct
			No	4-3
	4-3	Air short circuit has occurred. This is a phenomenon when discharged air (exhaust heat) from the outdoor unit is drawn back into the suction vent.	Yes	Prevent air short circuit
			No	4-4
	4-4	Indoor air intake temperature is high.	Yes	Take measures
			No	4-5
	4-5	The filter of the indoor unit is clogged.	Yes	Clean the filter
			No	4-6
	4-6	Air short circuit has occurred. This is a phenomenon when discharged air (exhaust heat) from the indoor unit is drawn back into the suction vent.	Yes	Prevent air short circuit
			No	5-1
5 Check operation	5-1	Possible to operate.	Yes	5-2
			No	6-1
	5-2	Operating pressure is affected by pressure overload.	Yes	5-3
			No	5-4
	5-3	Tends to have an overcharge of refrigerant in the system.	Yes	Adjust the amount of refrigerant
			No	5-4
	5-4	Tends to operate for a long time turning gas back into liquid.	Yes	Check the operation of functional parts
			No	5-5
	5-5	Tends to have insufficient refrigerant charge in the system.	Yes	Adjust the amount of refrigerant
			No	5-6
	5-6	Even though the high pressure saturation temperature is 43°C or less, the secondary current of the inverter is high. (The frequency (Hz) ends up dropping due to the current.)	Yes	Replace the compressor
			No	See what happens.
6 Check history	6-1	Dividing the outdoor EEPROM INV operation time by the number of times oil was supplied to the system yields 3 hours or less.	Yes	6-2
			No	6-2
	6-2	There is a history of H31 in the pre-trip counter of the outdoor EEPROM alarm history.	Yes	Replace the compressor and add oil. However if 6-1 was "no," it is not necessary to add oil.
			No	7-1
7 Check the HIC boards	7-1	The results of HIC board IPM Pass/Fail Tests show the outside the range of the resistance of a conforming part listed in the next page.	Yes	Replace HIC board
			No	8-1
8 Check the compressor	8-1	The compressor is causing a failure in the insulation.	Yes	Replace the compressor
			No	8-2
	8-2	The winding resistance of the compressor is abnormal. Standard winding resistance HP: horse power 3-phase model (8HP, 10HP) U-V : 0.735 ohm U-W : 0.715 ohm V-W : 0.715 ohm	Yes	Replace the compressor
			No	9-1

9 Check the HIC PC boards	9-1	Replace the HIC PC board and operate the unit. (Apply putty and screws must not be loose) Does it operate normally?	Yes	See what happens.
			No	10-1
10 Check the outdoor unit main PC board	10-1	Replace the control PC board and operate the unit.	See what happens.	

- (Check content of 7) The test check of the HIC board is only a check on the output level, so the input stage may not be working.
- With the filter board broken, alarm P16 may not be triggered.

• **HIC board IPM Pass/Fail Tests**

- Measure with an analog tester. (Set to the k ohm range.)
- Measure the board by itself. (Remove wires connected from other parts.)
- Measure using IPM terminals.

★ **Conforming part resistance value (measure with an analog tester)**

Tester terminals								
+	P				NU			
-	U	V	W	NU	U	V	W	P
Resistance value (ohm)	1 k to 5 k	1 k to 5 k	1 k to 5 k	5 k to 10 k	100 k to ∞	100 k to ∞	100 k to ∞	100 k to ∞

Tester terminals								
-	P				NU			
+	U	V	W		U	V	W	
Resistance value (ohm)	100 k to ∞	100 k to ∞	100 k to ∞		1 k to 5 k	1 k to 5 k	1 k to 5 k	

- Excepting the parts of “100 k to ∞”, it is acceptable if a small resistance value appears as a reference value unless the value is “0 = short-circuit”.

Tester terminals								
+	HIC+				HIC-			
-	U	V	W	HIC-	U	V	W	HIC+
Resistance value (ohm)	1 k to 10 k	1 k to 10 k	1 k to 10 k	5 k to 20 k	20 k to ∞	20 k to ∞	20 k to ∞	20 k to ∞

Tester terminals								
-	HIC+				HIC-			
+	U	V	W		U	V	W	
Resistance value (ohm)	20 k to ∞	20 k to ∞	20 k to ∞		1 k to 10 k	1 k to 10 k	1 k to 10 k	

- Excepting the parts of “20 k to ∞”, it is acceptable if a small resistance value appears as a reference value unless the value is “0 = short-circuit”.

P22 Outdoor Unit Fan Motor Trouble

1. Error Detection Method

- It is judged an error when the outdoor fan motor's rotating signal cannot be detected normally.

2. Error Diagnosis

1 Wiring	1-1	Are the connectors "CN-FM_UP" and "CN-FM_LO" firmly connected to the outdoor control PC board (lock engaged)?	Yes	2-1
			No	Correct the connector connections
2 Outdoor fan motor	2-1	Disconnect the connectors "CN-FM_UP" and "CN-FM_LO" from the outdoor control PC board and rotate the outdoor fan by hand; does it rotate freely? (Check the outdoor fan motor lock)	Yes	3-1
			No	Replace the outdoor fan motor
3 Outdoor control PC board	3-1	Turn the power on and run the unit again; is P22 triggered again? Or can you see or hear anything that is obviously wrong in its rotation?	Yes	3-2
			No	3-3
	3-2	Replace the outdoor control PC board. (If it fails to operate normally even after replacing the outdoor control PC board, replace the outdoor fan motor.)		
	3-3	If there is nothing particularly out of the ordinary, see what happens.		

P29 Lack of INV compressor wiring, INV compressor actuation failure (including locked), DCCT failure

1. Error Detection Method

- Abnormal current is detected at DCCT before start-up.
- Start-up failed during overcurrent and/or step-out detected.
- Open-wire of compressor and/or backspin detected.
- Secondary current is not detected during INV compressor is running.

2. Error Diagnosis

1 Wiring	1-1	Disconnected parts, miswiring and/or poor connections (loose) are observed in the connections of HIC PC board(s) that are connected by wiring to a compressor. *1	Yes	Correct wiring connections
			No	1-2
	1-2	Disconnected parts, miswiring and/or poor connections (loose) are observed in the connections of outdoor board(s) that are connected by wiring from the HIC PC board. *1	Yes	Correct wiring connections
			No	2-1
2 Compressor wiring	2-1	Disconnections and/or miswiring is observed in the connections of the compressor terminals. *1	Yes	Correct
			No	2-2
	2-2	Conditions such as burned terminal covers and/or discolored terminals are observed at the connectors of the compressor terminals. *1	Yes	Eliminate looseness by changing the terminals, or crimping the terminals again.
			No	3-1
3 Check the HIC PC boards	3-1	The results of the pass/fail tests for the following HIC PC board IPM show it to be outside the range of the resistance of a conforming part.	Yes	Replace the HIC board
			No	3-2
	3-2	Replace the HIC PC board and operate the unit. (Apply putty and screws must not be loose) Does it operate normally?	Yes	See what happens.
			No	4-1
4 Check the outdoor control PC board	4-1	Replace the control PC board and operate the unit.	See what happens.	

*1 Checking for looseness of compressor terminals by wiggling them has the adverse effect of loosening them, so do not do it. Evaluate them by discoloration of wire insulation near the terminal.

• HIC board IPM Pass/Fail Tests

- Measure with an analog tester. (Set to the k ohm range)
- Measure the board by itself. (Remove wires connected from other parts.)
- Measure using IPM terminals.

★ Conforming part resistance value (measure with an analog tester)

Tester terminals	P				NU			
+	U	V	W	NU	U	V	W	P
Resistance value (ohm)	1 k to 5 k	1 k to 5 k	1 k to 5 k	5 k to 10 k	100 k to ∞	100 k to ∞	100 k to ∞	100 k to ∞

Tester terminals	P				NU			
-	U	V	W		U	V	W	
Resistance value (ohm)	100 k to ∞	100 k to ∞	100 k to ∞		1 k to 5 k	1 k to 5 k	1 k to 5 k	

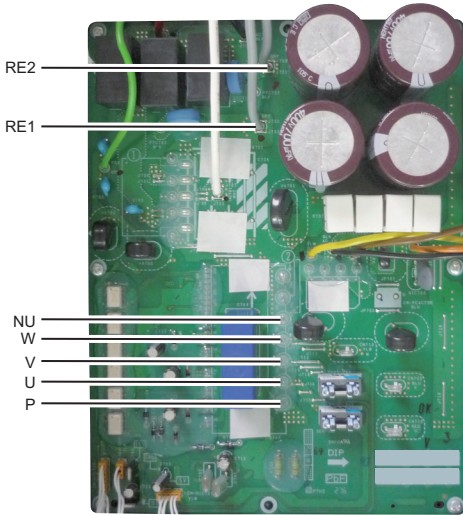
- Excepting the parts of "100 k to ∞", it is acceptable if a small resistance value appears as a reference value unless the value is "0 = short-circuit".

Tester terminals	HIC+				HIC-			
-	U	V	W	HIC-	U	V	W	HIC+
Resistance value (ohm)	1 k to 10 k	1 k to 10 k	1 k to 10 k	5 k to 20 k	20 k to ∞	20 k to ∞	20 k to ∞	20 k to ∞

Tester terminals	HIC+				HIC-			
+	U	V	W		U	V	W	
Resistance value (ohm)	20 k to ∞	20 k to ∞	20 k to ∞		1 k to 10 k	1 k to 10 k	1 k to 10 k	

- Excepting the parts of "20 k to ∞", it is acceptable if a small resistance value appears as a reference value unless the value is "0 = short-circuit".

■ Outdoor Unit Control HIC PCB
ACXA73-3104* : (U-200PZH2E8, U-250PZH2E8)
(3-phase outdoor unit HIC PC board)



P31 Group Control Error

1. Error Detection Method

- Other indoor unit alarms within the group.

1 Other indoor unit	1-1	Survey the indoor unit that alarms other than "P31" in the indoor unit group and specify the causes of failure.
---------------------	-----	---

5-4. Inspection of Parts (Outdoor Unit)

(1) Electronic control valve (MOV1)

- MOV1: Measure the voltage between plug pin 5 and pins 1 through 4 at the CN-MOV1 connector (5P, white) on the outdoor unit control PCB. (Because of the pulse output, a simplified measurement method is used. Set the tester to the 12 V range; if the value displayed is approximately 4 V, then the voltage is normal.)
If the voltage is normal, measure the resistance between connector pin 5 and pins 1 through 4.
Resistance between pin 5 and pins 1 through 4 should be approximately 46 ohm for all. (If the result is 0 ohm or, ∞ then replace the coil.)

(2) Outdoor Unit Fan Motor

Model No.	Part No. (Panasonic)	Part No.
U-200PZH2E8, U-250PZH2E8	L6CBYYYYL0296	NFD-81FW-D8120-6
	L6CBYYYYL0297	NFD-81FW-D8120-7

(3) Coil Resistance of Compressor

Model No.	Part No. (Panasonic)	Part No.	Inverter compressor (at 20°C)		
			U - V	V - W	U - W
U-200PZH2E8	ACXB09-07100	9VD550XAA21	0.735	0.715	0.715
U-250PZH2E8	ACXB09-07100	9VD550XAA21	0.735	0.715	0.715

5-5. Symptom: Thermostat in OFF continues or cycles OFF & ON too frequently

1. How to detect abnormality

- Abnormality does not occur. Protective function can be checked when the outdoor maintenance remote controller is connected.

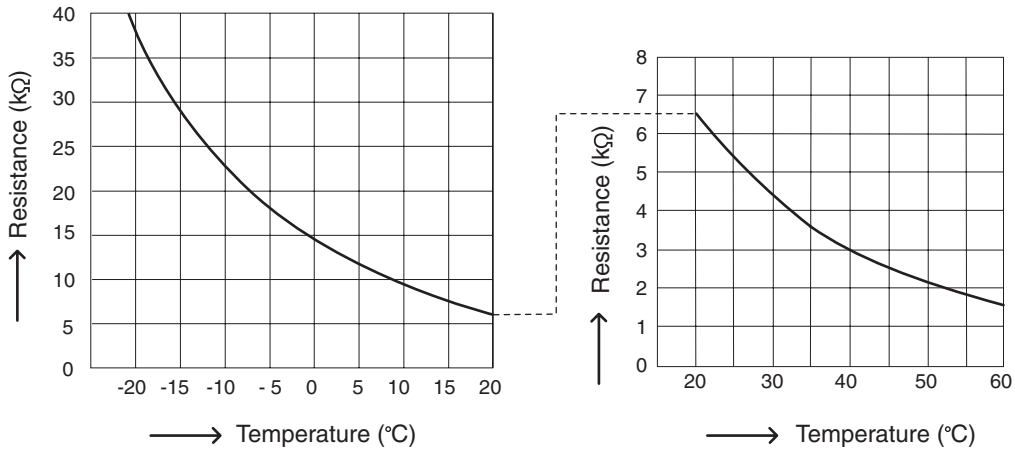
2. Error Diagnosis

1 Indoor control PC board	1-1	Setting temperature reaches the level set ON thermostat. Setting temperature is too low in heating mode and too high in cooling and dry mode.	Yes	Adjust setting temperature
			No	1-2
	1-2	Check if the sensors are connected correctly. Are all connection made properly? Room temp. (TA) in yellow, heat exchanger (E1) in red, heat exchanger (E2) in black.	Yes	Connect correctly
			No	1-3
	1-3	DISP (display mode) is applied.	Yes	Turn OFF(OPEN)
			No	1-4
	1-4	With a thermostat OFF in heating mode, wind speed (item code 05) is out of range 0 - 6. (Use Simple Setting Function on standard timer remote controller.)	Yes	Choose one of 0 to 6
			No	1-5
	1-5	DEMAND is applied.	Yes	Turn OFF(OPEN)
			No	2-1
2 Outdoor control PC board	2-1	Outdoor unit and protective function of a system are operating. (Connect outdoor maintenance remote controller to RC socket on outdoor unit main control PC board and check alarm messages.)	Yes	See operational status
			No	2-2
	2-2	Discharge temperature is over 80°C in stop mode and does not decrease. (Connect outdoor maintenance remote controller to RC socket on outdoor unit main control PC board and check alarm messages.)	Yes	Replace discharge temperature sensor
			No	2-3
	2-3	Demand value always stays low. (The value is lower than 70. Excluding -1 (unlimited))(Connect outdoor maintenance remote controller to RC socket on outdoor unit main control PC board and check alarm messages.)	Yes	Increase values (over 70)
			No	2-4
2-4	DEMAND is applied.	Yes	Turn OFF(OPEN)	
		No	3-1	
3 Control equipment	3-1	Demand setting is made by control units (P-AIMS, Seri-Para I/O unit for outdoor unit, Seri-Para I/O each indoor unit.)	Yes	Turn OFF
			No	4-1
4 System	4-1	When operating in cooling (including auto cooling & heating) and dry mode, lowest temp. of indoor E1 and E2 sensor is less than 2°C (under anti-freeze control).	Yes	Wait until more than 2°C reaches
			No	4-2
	4-2	During defrosting operation	Yes	Wait for a few minutes to 10 minutes or so
			No	4-3
	4-3	Outdoor unit PC board failure → Replacement		

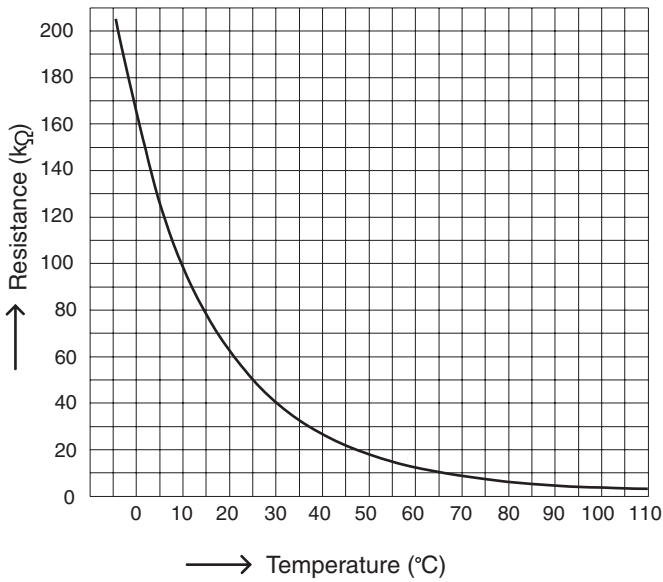
- According to a type of model, the indoor sensors will not be supplied in some cases.
- According to a type of model, the outdoor DEMAND will not be supplied in some cases.
- When LINE Checker is used, the temperature sensors can be observed (display, record) simultaneously.
- According to some areas, some of the models are unreleased.

5-6. Table of Thermistor Characteristics

- (1) Outdoor Air Temp. (TO) Sensor,
- Intake Temp. (TS) Sensor,
- Heat Exchanger Temp. (C1) Sensor,
- Heat Exchanger Temp. (C2) Sensor



- (2) Discharge Temp. (TD) Sensor



5-7. How to Remove the Compressor

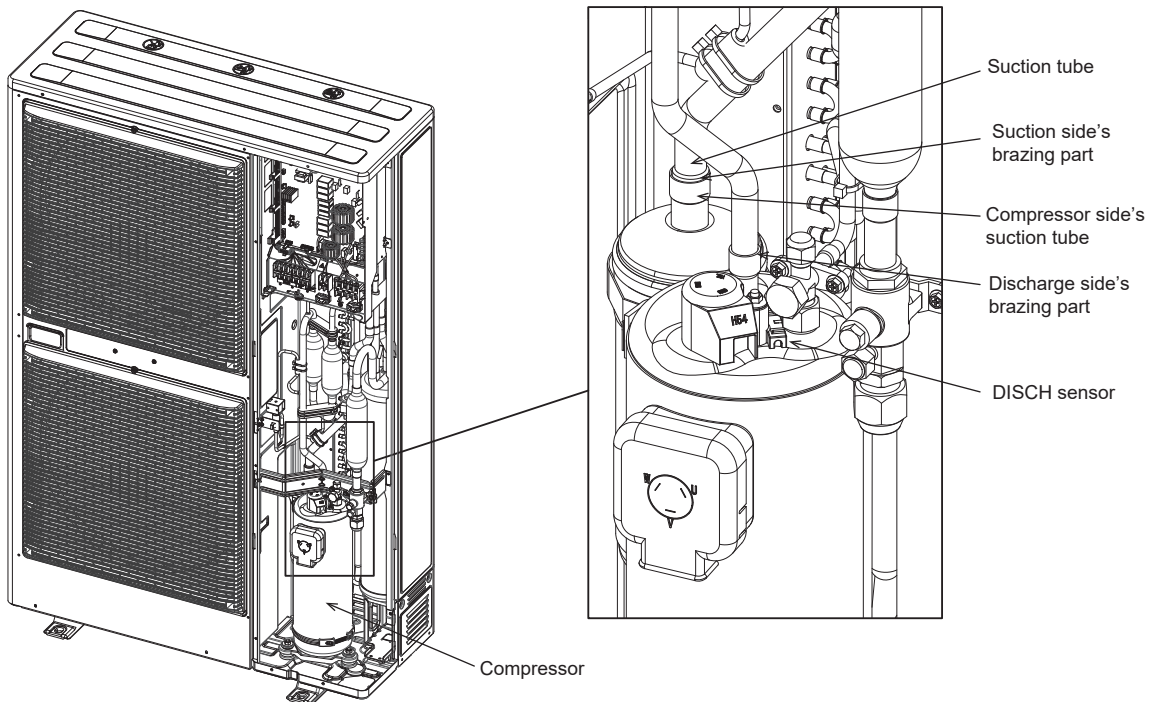
Pay careful attention to prevent water or foreign objects from entering into the refrigerant tubing when removing or installing the compressor.

Removing

1. After collecting the refrigerant in the system, replace nitrogen gas from the service port of the gas tubing valve.
2. Remove the sound absorbing material protecting the compressor.
3. Remove the cap of the compressor's terminal and then remove the power source terminal and TD sensor.
4. Remove the crank case heater.
5. Remove the bolts (×3) and then remove the washer and rubber spacer.
6. Cut off the compressor side's suction tube because the suction tube is solid and unmovable. See the diagram below.
7. Remove the discharge side's brazing part (×1). See the diagram below.

NOTE: Protect the sensor part, sheet metal, rubber, lead wire and clumper.

8. Pull the compressor toward you.
9. Remove the suction side's brazing part (×1) of the cut-off compressor side's suction tube connected to the suction tube.



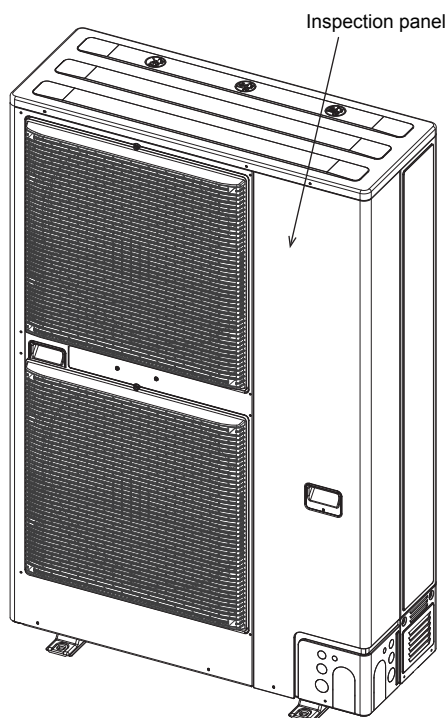
5-8. How to Remove the Electrical Component Box

Removing

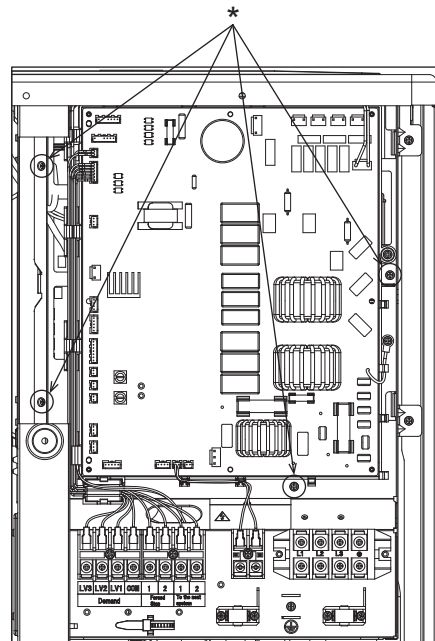
1. Remove the front panel and inspection panel from the outdoor unit.
2. Remove all local wires connected to the electrical component box.
3. Remove the wires (temperature sensor, coils of every sort of valve, pressure switch, fan motor and wires for connecting compressor) connected to the electrical component box in the unit.
4. Remove the fixture screws (×4) as shown in the diagram and remove the electrical component box.

NOTE:

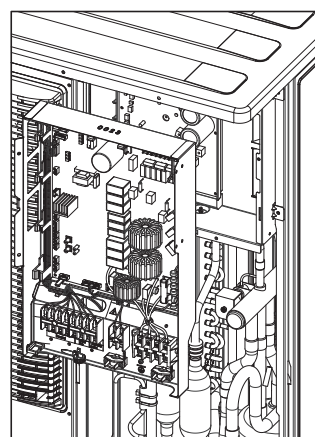
Be sure to remove the upper left side screw marked by * in the diagram because that screw cannot be seen from the front side.



Outdoor unit before removal of front panel



Fixture screws (×4) for electrical component box



Electrical component box after removal

5-9. Symptom: Thermostat in OFF continues or cycles OFF & ON too frequently

1. How to detect abnormality

- Abnormality does not occur. Protective function can be checked when the outdoor maintenance remote controller is connected.

2. Error Diagnosis

1 Indoor control PC board	1-1	Setting temperature reaches the level set ON thermostat. Setting temperature is too low in heating mode and too high in cooling and dry mode.	Yes	Adjust setting temperature
			No	1-2
	1-2	Check if the sensors are connected correctly. Are all connection made properly? Room temp. (TA) in yellow, heat exchanger (E1) in red, heat exchanger (E2) in black.	Yes	Connect correctly
			No	1-3
	1-3	DISP (display mode) is applied.	Yes	Turn OFF(OPEN)
			No	1-4
1-4	With a thermostat OFF in heating mode, wind speed (item code 05) is out of range 0 - 6. (Use Simple Setting Function on standard timer remote controller.)	Yes	Choose one of 0 to 6	
		No	1-5	
1-5	EXCT(demand control) is applied.	Yes	Turn OFF(OPEN)	
		No	2-1	
2 Outdoor control PC board	2-1	Outdoor unit and protective function of a system are operating. (Connect outdoor maintenance remote controller to RC socket on outdoor unit main control PC board and check alarm messages.)	Yes	See operational status
			No	2-2
	2-2	Discharge temperature is over 80°C in stop mode and does not decrease. (Connect outdoor maintenance remote controller to RC socket on outdoor unit main control PC board and check alarm messages.)	Yes	Replace discharge temperature sensor
			No	2-3
2-3	Demand value always stays low. (The value is lower than 70. Excluding -1 (unlimited))(Connect outdoor maintenance remote controller to RC socket on outdoor unit main control PC board and check alarm messages.)	Yes	Increase values (over 70)	
		No	2-4	
2-4	DEMAND or EXCT(demand control) is applied.	Yes	Turn OFF(OPEN)	
		No	3-1	
3 Control equipment	3-1	Demand setting is made by control units (P-AIMS, Seri-Para I/O unit for outdoor unit, Seri-Para I/O each indoor unit.)	Yes	Turn OFF
			No	4-1
4 System	4-1	When operating in cooling (including auto cooling & heating) and dry mode, lowest temp. of indoor E1 and E2 sensor is less than 2°C (under anti-freeze control).	Yes	Wait until more than 2°C reaches
			No	4-2
	4-2	During defrosting operation	Yes	Wait for a few minutes to 10 minutes or so
			No	4-3
	4-3	Outdoor unit PC board failure → Replacement		

- According to the type of models, the indoor sensors will not be supplied in some cases.
- According to the type of models, the outdoor DEMAND or EXCT will not be supplied in some cases.
- When LINE Checker is used, the temperature sensors can be observed (display, record) simultaneously.
- According to some areas, some of the models are unreleased.

– MEMO –

6. OUTDOOR UNIT MAINTENANCE REMOTE CONTROLLER

In the case of CZ-RTC4

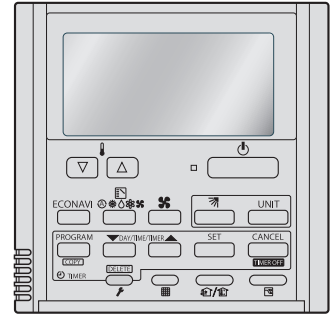
6-1. Overview	6-2
6-2. Functions.....	6-2
6-3. Normal Display Operations and Functions	6-3
6-4. Monitoring Operations: Display of Indoor Unit and Outdoor Unit Sensor Temperatures	6-8
6-5. Monitoring the Outdoor Unit Alarm History: Display of Outdoor Unit Alarm History	6-10
6-6. Settings Modes: Setting the Outdoor Unit EEPROM.....	6-11

6-1. Overview

What is the outdoor unit maintenance remote controller?

Beginning with the DC-INV series of outdoor units, nonvolatile memory (EEPROM) is used in the outdoor unit PCB. In this way, the setting switches that were located on earlier PCBs have been converted to EEPROM data. This remote controller is an outdoor unit maintenance tool that is used to make and change the EEPROM settings.

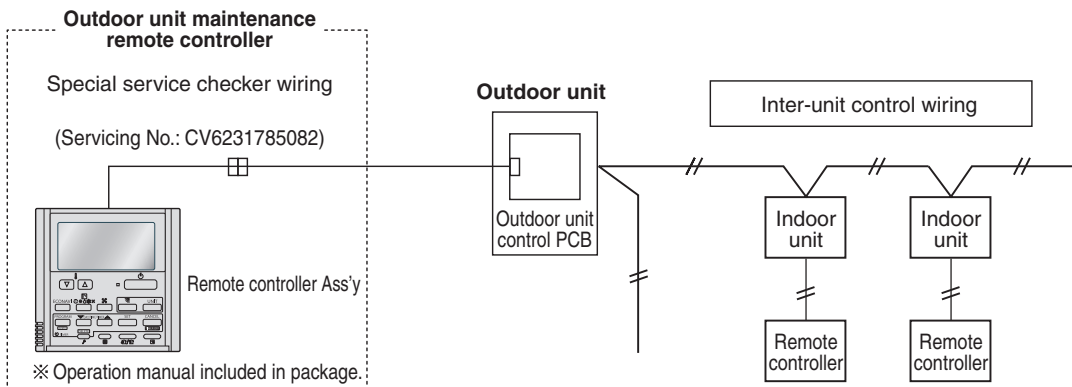
This remote controller can be used for checking the outdoor unit EEPROM settings and contents, and also can be used to monitor the outdoor unit alarm history and indoor/outdoor unit temperatures, and to check the status of the indoor unit connections (No. of units, operating status, etc.).



CZ-RTC4

Note: Because this tool does not function as a remote controller, it is used only during test runs and servicing.

System diagram



- * The special service checker wiring is required in order to connect the outdoor unit maintenance remote controller to the outdoor unit PCB.
- * Even when the outdoor unit maintenance remote controller is connected, a separate remote controller or other control device must be connected to the indoor unit.

6-2. Functions

■ Normal display functions

(1) Functions: Button operations can be used to perform the following functions.

- Start/stop of all indoor units
- Switching between cooling and heating
- Test run of all indoor units
- High-speed operation of indoor units (Do not use with actual units. This may damage the devices.)

(2) Display: The following can be displayed.

- Alarm details display
- No. of indoor/outdoor units
- Unit Nos. of connected indoor/outdoor units
- Indoor/outdoor unit operating status (blinks when an alarm occurs)
- Indoor unit thermostat ON
- Individual display of outdoor unit alarms
- Outdoor unit compressor total operating time
- Outdoor unit total power ON time
- Outdoor unit microcomputer version
- Other

■ Temperature monitor

- Displays the indoor/outdoor unit sensor temperatures.

■ Outdoor unit alarm history monitor

- Displays the outdoor unit alarm history.

■ Setting modes

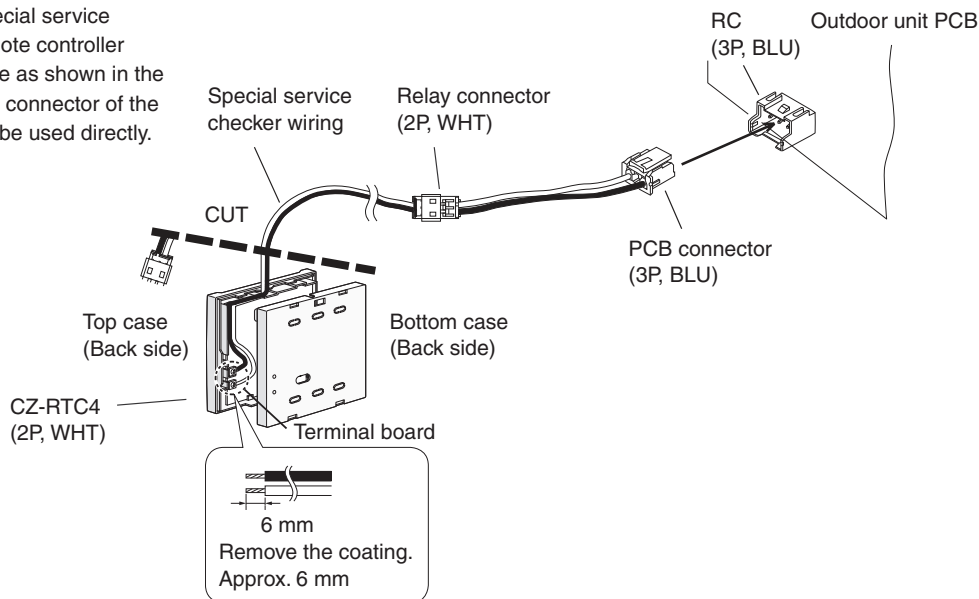
- Setting mode 1 and setting mode 2 are used to make the outdoor EEPROM setting.

6-3. Normal Display Operations and Functions

■ Normal display functions

- Connect the special service checker wiring to the outdoor unit PCB. The connection is shown in the figure below.


When connecting the special service checker wiring to the remote controller CZ-RTC4, cut out the wire as shown in the figure below because the connector of the remote controller cannot be used directly.



- * It is not necessary to disconnect the communications line in the inter-unit control wiring if it has already been connected at this time.
- * Setting modes 1 and 2 can be used even when the outdoor unit is independent (when 1 maintenance remote controller is connected to 1 outdoor unit and automatic address setting for the indoor units has not been completed).
- * Displays the overall system status for that refrigerant system.
- * “SETTING” is displayed until auto address setting is completed.

● **All units start/stop (Fig. 6-1)**

<Operation>

The  (Start/Stop operation) button can be used to start and stop all the indoor units.


- The LED illuminates if any indoor units is operating.
- The LED blinks if an alarm at any of the operating indoor units occurs.

● **Cooling/heating change (Fig. 6-1)**

NOTE

Cooling and heating mode changes are only available when all indoor units are stopped.


<Operation>

The  (Mode) button can be used to change between heating and cooling operation.

- The display indicates the operating mode of the indoor unit with the lowest unit No.

● **All units test run (Fig. 6-2)**

<Operation>

The  (Check) button can be used to start and stop a test run for all indoor units.

- Press and hold for 4 seconds to turn ON. During the test run “TEST” is displayed.
- The status of test runs performed from the indoor unit remote controller is not displayed on the outdoor unit maintenance remote controller.

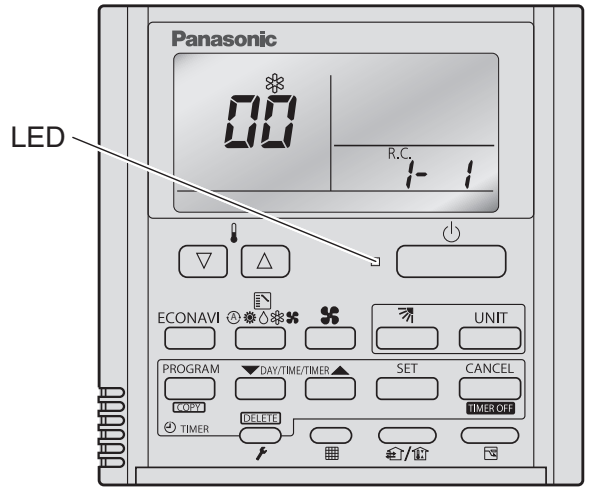


Fig. 6-1

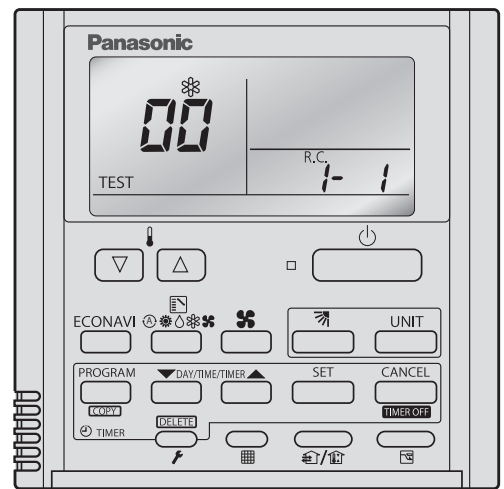




Fig. 6-2

● **Double-speed (Fig. 6-3)**

- Do not use for actual operation. (Doing so may damage the devices.)

<Operation>

The timer button  can be used to change between double-speed and normal operation.

- During double-speed operation, the Sleeping Mode  mark is displayed.

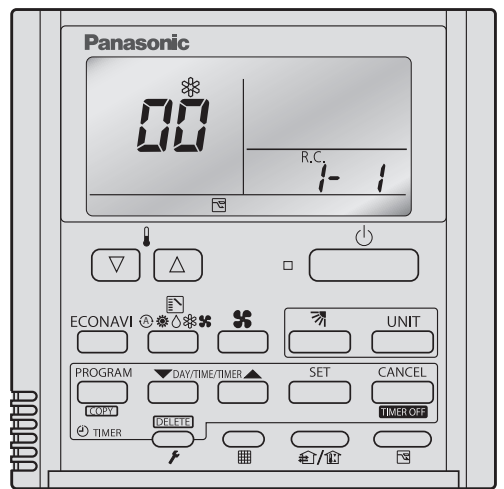


Fig. 6-3

■ Display (functions)

- Use the temperature setting Δ and ∇ buttons to change the item code.

(1) Item code	(2) Item	Remarks
00	Outdoor unit alarm	Alarm code display
01	No. of connected indoor units	Quantity
02	Unit Nos. of connected indoor unit	7-segment display
03	Operating status of indoor unit	7-segment display
04	Thermostat ON status of indoor unit	7-segment display
05	No. of connected outdoor units	1 – 4
06	Unit Nos. of connected outdoor units	7-segment display
07	Operating status of outdoor unit compressor	7-segment display
08		
09		
10	Compressor 1 operating time	0 – 99999999 hours
11		
13		
14		
16	Outdoor unit power ON time	0 – 99999999 hours
17	Compressor 1 operation count	0 – 65535 times
18		
F0	Alarm history 1 (most recent)	Display only. Alarm code and unit No. of unit where alarm occurred are displayed alternately. 0 = CCU 1 – 4 = Outdoor unit
F1	Alarm history 2	
F2	Alarm history 3	
F3	Alarm history 4	
F4	Alarm history 5	
F5	Alarm history 6	
F6	Alarm history 7	
F7	Alarm history 8 (oldest)	
FE	Firmware version	Display the version No. × 100.
FF	Program version	Display the version No. × 100.

(1) and (2) correspond to Fig. 6-4 on the next page.

(3) XX-YY R.C.

Displays the outdoor unit sub-bus address which is currently selected.

XX = Outdoor system address on main bus line (1 – 30)

YY = Outdoor unit sub-bus address (1 – 8)

“1” appears when there is only 1 outdoor unit.

Locations where (1), (2), and (3) are displayed as shown in Fig. 6-4.

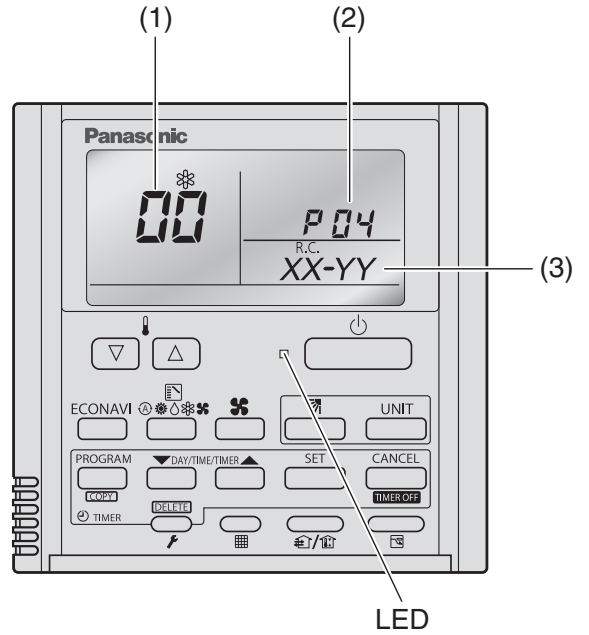
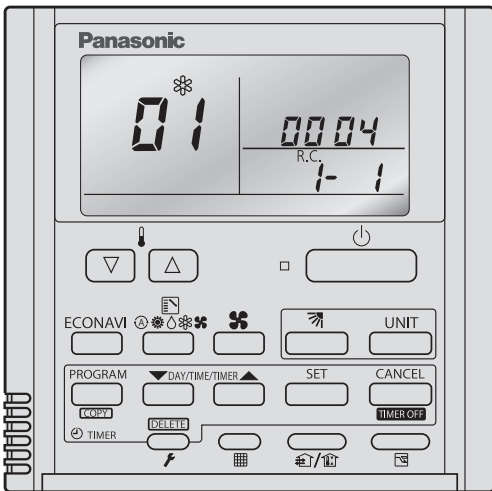


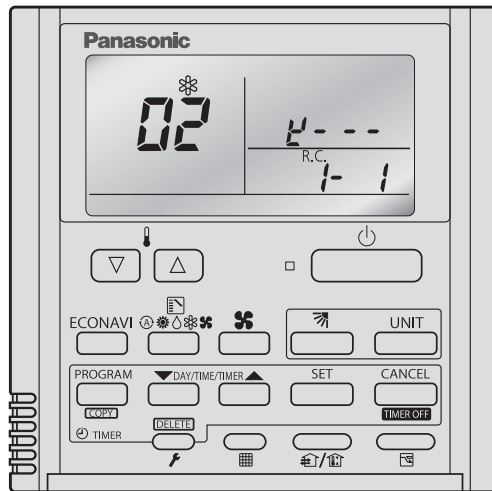
Fig. 6-4

<Sample displays>



01: <No. of connected indoor units>
4 units connected

Fig. 6-5



02: <Unit Nos. 1, 2, 3, and 4 are connected>

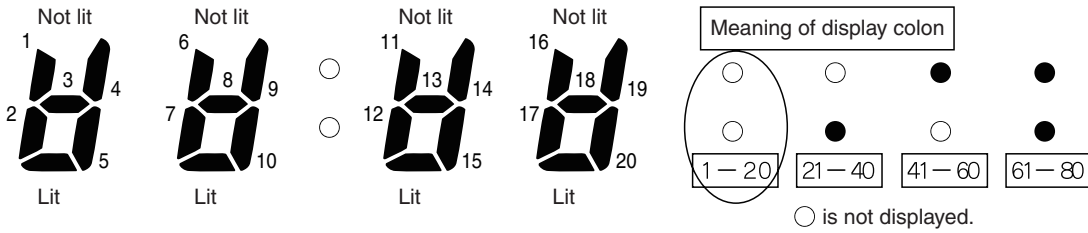
Fig. 6-6

6

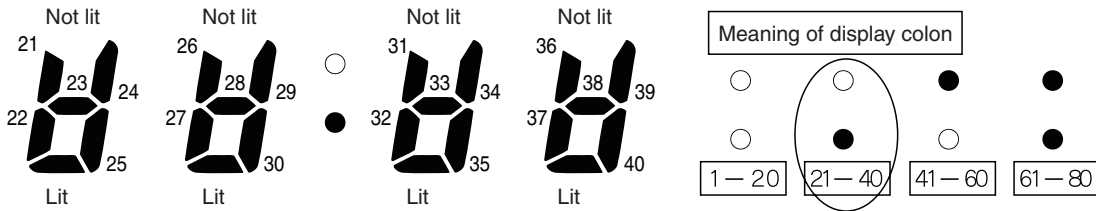
■ 7-segment, 4-digit display for remote controller timer display

The connected unit Nos. are displayed as shown below, using the 7-segment 4-digit (00:00) display and the colon.

● Display for unit Nos. 1 – 20

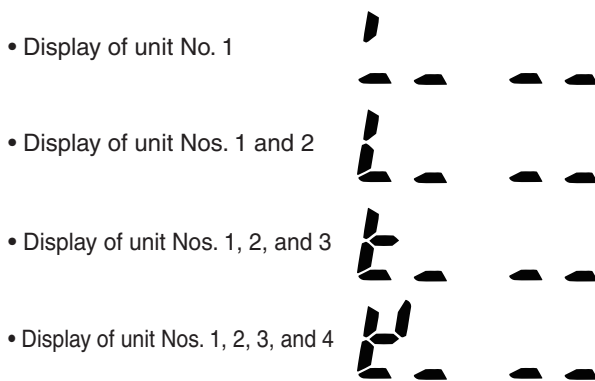


● Display for unit Nos. 21 – 40



● The meaning of the colon display changes in the same way, allowing unit Nos. up to 80 to be displayed.

● Sample displays of the unit Nos. of connected indoor units

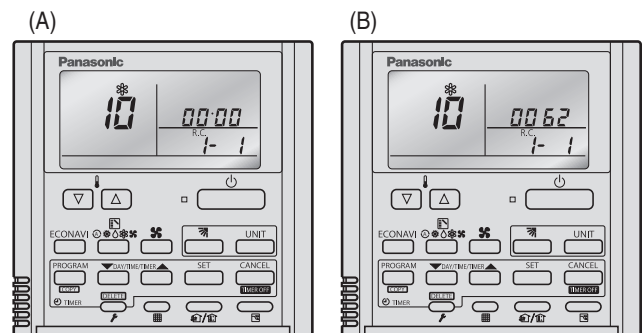


NOTE

The change of the colon display (between unit Nos. 1-20 to unit Nos. 21-40) occurs automatically every 10 seconds. (However the display does not change if there are no higher-number units connected.) To change the display to the higher-number units before 10 seconds have passed, press the (Flap) button.

■ The total compressor operating time is displayed (in 1-hour units) using 8 digits.

- When the first 4 digits are displayed, the top dot of the colon is illuminated. (Figure (A))
- When the last 4 digits are displayed, the colon dot is OFF. (Figure (B))
- The display of the first 4 digits and last 4 digits changes automatically after 10 seconds. The display can also be changed by pressing the (Flap) button.





10: <Compressor's total operating time>
(A) and (B) are displayed alternately.
(The example here (0000, 0062) indicates 62 hours.)

NOTE

With the outdoor unit maintenance remote controller (when connected to the outdoor unit), the unit remote controller check functions will not operate.


6-4. Monitoring Operations: Display of Indoor Unit and Outdoor Unit Sensor Temperatures



<Operating procedure>

- (1) Press and hold the  (Check) button and  buttons simultaneously for 4 seconds or longer to engage temperature monitor mode.


During temperature monitoring,  is illuminated.

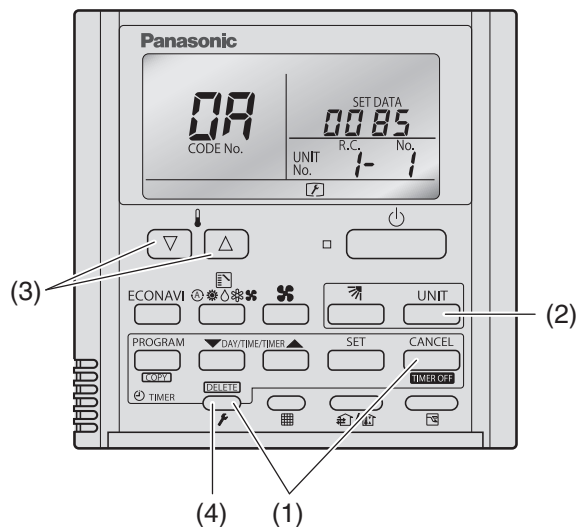
(The display and operations are the same as for monitor mode using the indoor unit remote controller.)

- (2) Press the  button and select the indoor unit to monitor.

- (3) Press the temperature setting  and  buttons and select the item code of the temperature to monitor.

The unit No. of the selected indoor unit, and the temperature data, are displayed.

- (4) To end monitoring, press the  (Check) button. The display returns to the normal display.



NOTE The display does not blink.

■ Display of unit No. 1 (main unit)

	Item code	Meaning of Code
Indoor unit data	02	Indoor unit intake temp.
	03	Indoor unit heat exchanger temp. (E1)
	04	Indoor unit heat exchanger temp. (E2)
	05	–
	06	–
	07	–
	08	–
	09	–
	Outdoor unit data	0A
0b		–
0C		–
0d		Intake temp. (TS)
0E		Outdoor unit heat exchanger temp. (C1)
0F		Outdoor unit heat exchanger temp. (C2)
10		–
11		Outdoor air temp. (TO)
12		–
13		Current value (CTL2)
14		Current value (CTL1)
15		Outdoor MV value (MOV1)
16		–
19		Frequency



* Depending on the model, some items may not be displayed.

6-5. Monitoring the Outdoor Unit Alarm History: Display of Outdoor Unit Alarm History

* Displays outdoor unit alarms only. Does not display indoor unit alarms.




* Check the indoor unit alarm histories separately using the indoor unit remote controllers or other control device.

<Operating procedure>

- (1) Press and hold the  (Check) button and  button simultaneously for 4 seconds or longer to engage outdoor unit alarm history mode.

During temperature monitoring,  illuminates.

The display and operations are the same as for the alarm history monitor performed from the indoor unit remote controller. However the "UNIT No." display shows the outdoor unit address.

- (2) Press the  button and select the outdoor unit for which to monitor the alarm history.
- (3) Press the temperature setting  and  buttons and select the item code for the alarm history.

The select outdoor unit address, the item code, and the alarm history (alarm data) are displayed.

The outdoor unit address is displayed as R.C. XX-YY.



System XX = Outdoor unit system address

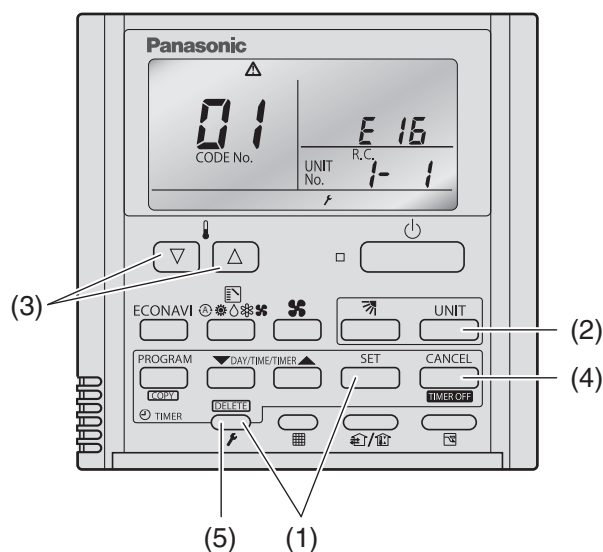
R.C. XX = Outdoor unit system address

YY = Outdoor unit sub-bus address

Item codes 01-08 are displayed. 01 indicates the most recent alarm.

The alarm history displays the alarm code. (If no alarm are present, then -- -- is displayed.)







- (4) To clear the alarm history, press the  button. (The outdoor unit alarm history will be cleared.)
- (5) To exit, press the  (Check) button. The display returns to the normal display.




6-6. Settings Modes: Setting the Outdoor Unit EEPROM

● Setting mode 1

<Operating procedure>

- (1) Press and hold the  (Check) button and  (Ventilation) button simultaneously for 4 seconds or longer.
- (2) Press the temperature setting  and  buttons to change the item code. The item codes and setting data are shown on the next page.
- (3) Press the timer time  and  buttons to change the setting data.


To confirm the changed setting data, press the  button.

(At this time, “SETTING” display stops blinking and remains lit.)

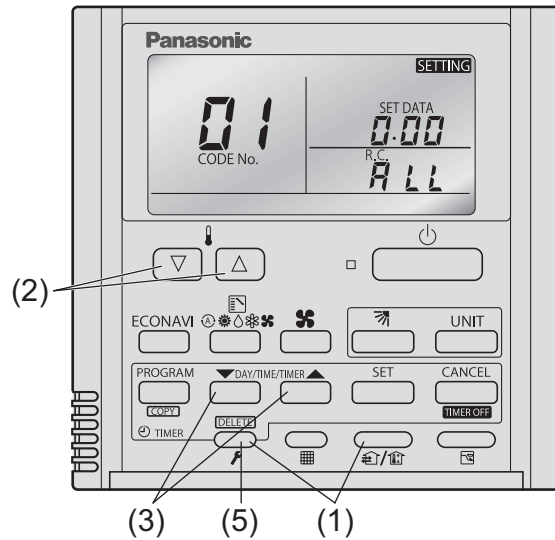
- (4) During this mode, “SETTING” is displayed, blinking. The outdoor unit address display section displays “ALL,” the item code and number (DN value in the table), and the setting data (6 digits).

(The setting data is displayed in 6 digits. The display changes between the first 3 digits (Fig. (C)). and the last 3 digits (Fig. (D)).

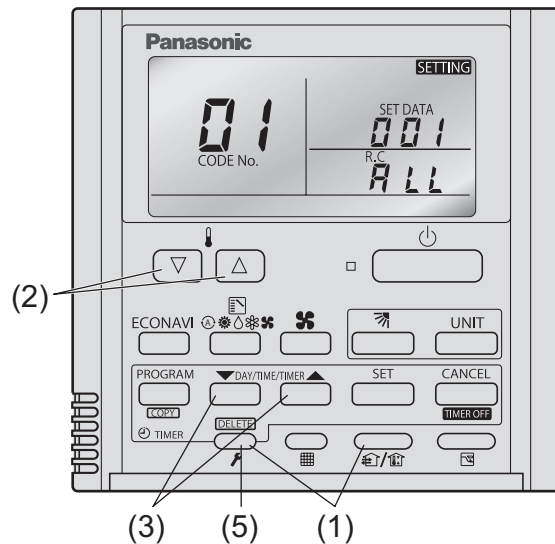
(When the first 3 digits are displayed, the bottom dot of the colon is illuminated.)

- (5) To exit the setting mode, press the  (Check) button.

(C) Display of first 3 digits



(D) Display of last 3 digits



(C) and (D) are displayed alternately.
(Example shows display of 000 001.)

Never use the DN code unlisted in the following table.

(P) : Factory preset mode

DN	Item	Setting No.	
05	Outdoor fan silent mode	1=Silent mode 1 (P) 2=Silent mode 2,,,,,	3=Silent mode 3
07	Capacity matching ignored	0=Invalid (P)	1=Valid
0C	Indoor unit drain pump forced operation	0=Invalid 1=stop for 2 hours and drive for 20 minutes constantly 2=stop for 20 minutes and drive for 20 minutes constantly 3=Drive constantly 4-6=delay drive when thermostat OFF 7=delay drive when thermostat OFF (P)	
0D	Measures against smell when indoor unit cooling thermostat OFF	0=Invalid (P) 1=Measures against smell	
1A	Demand 1 current (%)	0=0% 45=45%,,,,, 130=130%	40=40% 75=75% (P) ,,,,, -1=No control
1B	Demand 2 current (%)	0=0% 45=45%,,,,, 130=130%	40=40% 50=50% (P) ,,,,, -1=No control
1D	Current control level	0=40% 1=45%,,,,, 12=100%,,,,, 16=120%,,,,, 18=130%,,,,, 19=-1(Invalid)(P)	
2B	DP operation time for slime measures	20=20 minutes 40=40 minutes 60=60 minutes	30=30 minutes (P) 50=50 minutes
80	Refrigerant Type	410=R410A(P), 22=R22, 407=R407C, 32=R32	
81	Outdoor unit capacity (Setting when the data is not stored in the EEPROM. Do not change under normal conditions.)	0=Invalid	224 (Type 200) 280 (Type 250)

7. REMOTE CONTROLLER FUNCTIONS SECTION










7-1.	Simple Settings Function.....	7-2
7-2.	List of Simple Setting Items.....	7-4
7-3.	Detailed Settings Function.....	7-5
7-4.	List of Detailed Setting Items.....	7-7
7-5.	Simple Setting Items.....	7-11
7-6.	Detailed Setting Items	7-13
7-7.	Remote Controller Servicing Functions	7-17
7-8.	Test Run Function.....	7-19

7-1. Simple Settings Function

- This allows the filter lifetime, operating mode priority change, central control address, and other settings to be made for an individual or group-control indoor unit to which the remote controller used for simple settings is connected.

When simple settings mode is engaged, operation stops at the individual or group-control indoor unit to which the remote controller for simple settings is connected.

<Procedure of CZ-RTC4>

- Press and hold the  and  buttons simultaneously for 4 seconds or longer.
- "**SETTING**", unit No. "**1-1**" (or "**ALL**" in the case of group control), item code "**01**", and settings data "**00XX**" are displayed blinking on the remote controller LCD display (Fig. 7-1). At this time, the indoor unit fan (or all indoor unit fans in the case of group control) begins operating.
- If group control is in effect, press the  button and select the address (unit No.) of the indoor unit to set. At this time, the fan at the indoor unit begins operating.
 - * If unit No. "**ALL**" is displayed, the same setting will be made for all indoor units.
- Press the temperature setting  /  buttons to select the item code to change.
- Press the timer time  /  buttons to select the desired setting data.
 - *For item codes and setting data, refer to the following page.
- Press the  button. (The display stops blinking and remains lit, and setting is completed.)
- Press the  button to return to normal remote controller display.

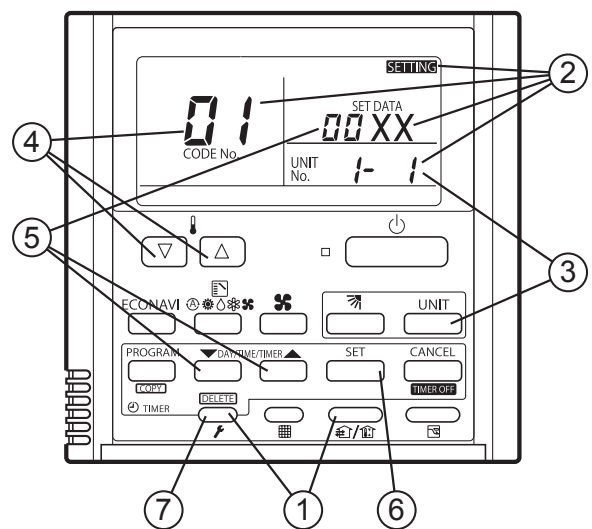


Fig. 7-1

<Procedure of CZ-RTC5B>

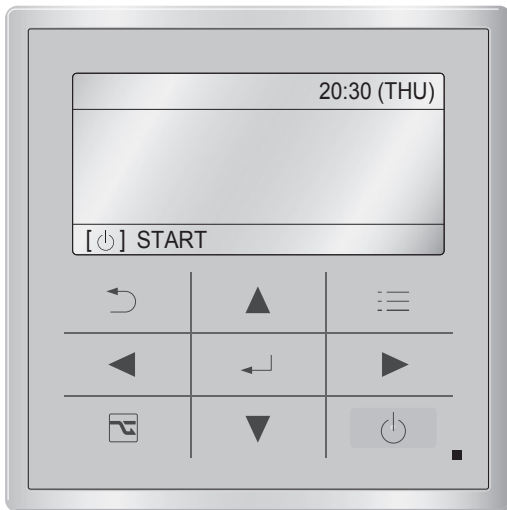



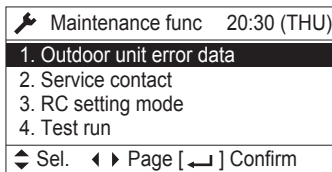





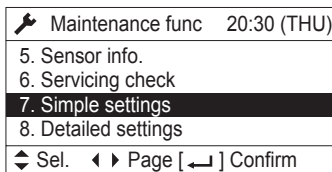


Fig. 7-2



- ① Keep pressing the ,  and  buttons simultaneously for 4 or more seconds. The "Maintenance func" screen appears on the LCD display.

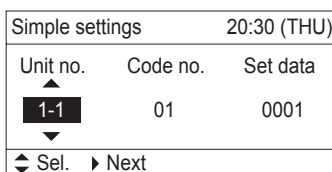






- ② Press the  or  button to see each menu. If you wish to see the next screen instantly, press the  or  button. Select "7. Simple settings" on the LCD display and press the  button.

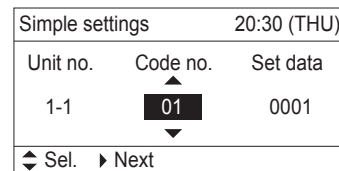







The "Simple settings" screen appears on the LCD display.

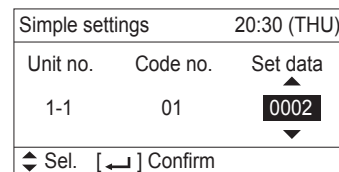
Select the "Unit no." by pressing the  or  button for changes.







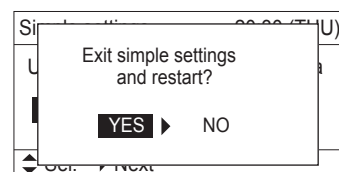
- ③ Select the "Code no." by pressing the  or  button. Change the "Code no." by pressing the  or  button.



- ④ Select the "Set data" by pressing the  or  button. Select one of the "Set data" by pressing the  or  button. Then press the  button.



- ⑤ Select the "Unit no." by pressing the  or  button and press the  button. The "Exit simple settings and restart?" (Simple setting-end) screen appears on the LCD display. Select "YES" and press the  button.



7-2. List of Simple Setting Items

Item code	Item	Setting data		
		No.	Description	
01	Filter sign ON time (filter life time)	0000	Not displayed	
		0001	150 hours	
		0002	2,500 hours	
		0003	5,000 hours	
		0004	10,000 hours	
		0005	Use the filter clogging sensor.	
02	Degree of filter fouling	0000	Standard (setting at time of shipping)	
		0001	Highly fouled (Filter sign ON time is reduced to one-half the set time.)	
03	Central control address	0001	Central control address 1	
		0002	Central control address 2	
		0003	Central control address 3	
		}	}	
		0064	Central control address 64	
		0099	No central control address set (setting at time of shipping)	
04	Operating mode priority change	0000	Normal (setting at time of shipping)	
		0001	Priority	
05	Fan speed when heating thermostat is OFF		Compressor ON	Compressor OFF
		0000	Lo 1 min., LL 3 min.	LL
		0001	Lo	LL
		0002	LL	LL
		0004	Lo 1 min., LL 3 min.	Lo
		0005	Lo	Lo
		0006	LL	Lo
06	Heating intake temperature shift	0000	No shift	
		0001	Shifts intake temperature 1 °C down.	
		0002	Shifts intake temperature 2 °C down.	
		0003	Shifts intake temperature 3 °C down.	
		0004	Shifts intake temperature 4 °C down.	
		0005	Shifts intake temperature 5 °C down.	
		0006	Shifts intake temperature 6 °C down.	
07	Electric heater installation	0000	No heater	
		0001	Heater installed	
08	Humidifying when heater thermostat is OFF	0000	No (setting at time of shipping)	
		0001	Yes	
0d	Permit/prohibit automatic heating/cooling	0000	Permit	
		0001	Prohibit	
0F	Cool-only	0000	Normal	
		0001	Cool only (Set "1" for item code OD.)	

NOTE









- In order to avoid water leakage and damage to the fan, do not set for humidifying when the thermostat is OFF unless a vaporizing humidifier is used.
- Consider the device purpose and type when changing the settings. Incorrect settings may result in malfunction.
- Do not change any setting data that does not appear in this list.

7-3. Detailed Settings Function



- This allows the system address, indoor unit address, and other settings to be made for the individual or group-control indoor unit to which the remote controller used for detailed settings is connected.

When detailed settings mode is engaged, operation stops at the individual or group-control indoor unit where the remote controller used for detailed settings is connected. Simple settings items can also be set at this time.

<Procedure of CZ-RTC4>

- Press and hold the ,  and  buttons simultaneously for 4 seconds or longer.
- "SETTING", unit No. "1-1" (or "ALL" in the case of group control), item code "10", and settings data "00XX" are displayed blinking on the remote controller LCD display (Fig. 7-3). At this time, the indoor unit fan (or all indoor unit fans in the case of group control) begins operating.
- If group control is in effect, press the  button and select the address (unit No.) of the indoor unit to set. At this time, the fan at the indoor unit begins operating.
- Press the temperature setting  /  buttons to select the item code to change.
- Press the timer time  /  buttons to select the desired setting data.

*For item codes and setting data, refer to the following page.

- Press the  button. (The display stops blinking and remains lit, and setting is completed.)
- Press the  button to return to normal remote controller display.

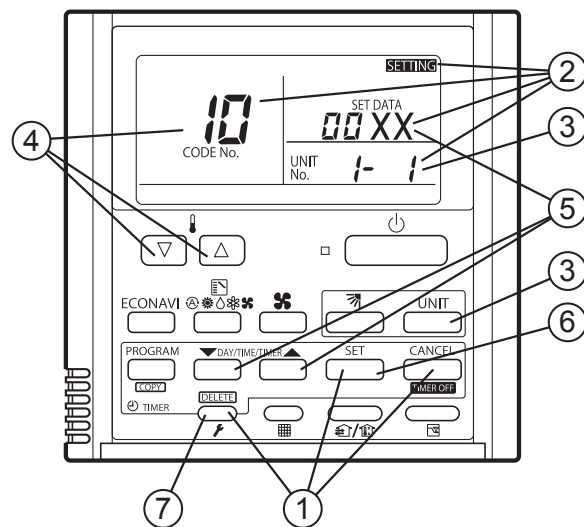


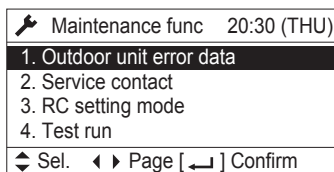
Fig. 7-3

<Procedure of CZ-RTC5B>

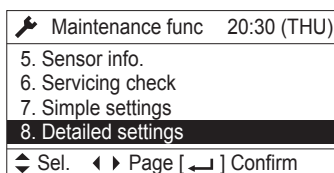


Fig. 7-4

- ① Keep pressing the , and buttons simultaneously for 4 or more seconds. The “Maintenance func” screen appears on the LCD display.

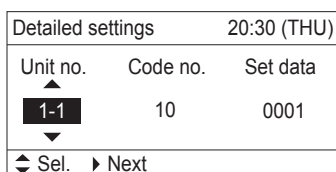


- ② Press the or button to see each menu. If you wish to see the next screen instantly, press the or button. Select “8. Detailed settings” on the LCD display and press the button.

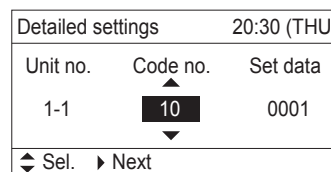


The “Detailed settings” screen appears on the LCD display.

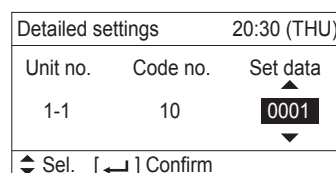
Select the “Unit no.” by pressing the or button for changes.



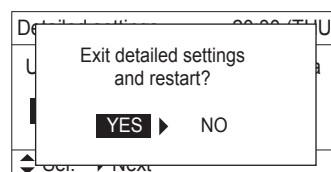
- ③ Select the “Code no.” by pressing the or button. Change the “Code no.” by pressing the or button (or keeping it pressed).



- ④ Select the “Set data” by pressing the or button. Select one of the “Set data” by pressing the or button. Then press the button.



- ⑤ Select the “Unit no.” by pressing the or button and press the button. The “Exit detailed settings and restart?” (Detailed setting-end) screen appears on the LCD display. Select “YES” and press the button.



7-4. List of Detailed Setting Items

Item code	Item	Setting data					
		No.	Description	No.	Description	No.	Description
10	Type	0000	_____	0001	4-Way Cassette (U2)	0002	_____
		0003	_____	0005	_____	0006	High Static Pressure Ducted (E3)
		0007	_____	0008	_____	0010	_____
		0011	_____		_____		_____
11	Indoor unit capacity	0001	_____	0003	_____	0005	_____
		0007	_____	0009	56 (Type 50)	0011	71 (Type 60)
		0012	80 (Type 71)	0015	112 (Type 100)	0017	140 (Type 125)
		0020	_____	0021	224 (Type 200)	0023	280 (Type 250)
12	System address	0001	Unit No. 1				
		0002	Unit No. 2				
		0003	Unit No. 3				
		}	}				
		0030	Unit No. 30				
		0099	Not set				
13	Indoor unit address	0001	Unit No. 1				
		0002	Unit No. 2				
		0003	Unit No. 3				
		}	}				
		0064	Unit No. 64				
		0099	Not set				
14	Group control address	0000	Individual (1:1 = Indoor unit with no group wiring)				
		0001	Main unit (One of the group-control indoor units)				
		0002	Sub unit (All group-control indoor units except for main unit)				
		0099	Not set				
17	Cooling intake temperature shift	-010	Shifts intake temperature 10°C down.				
		-009	Shifts intake temperature 9°C down.				
		}	}				
		-001	Shifts intake temperature 1°C down.				
		0000	No intake temperature shift				
		0001	Shifts intake temperature 1°C up.				
		}	}				
		0009	Shifts intake temperature 9°C up.				
0010	Shifts intake temperature 10°C up.						
18	Automatic stop time after operation start * Can be set in 5-minute units.	0000	Function disabled				
		0001	Stops automatically 5 minutes after operation starts.				
		0002	Stops automatically 10 minutes after operation starts.				
		}	}				
		0123	Stops automatically 615 minutes after operation starts.				
		0124	Stops automatically 620 minutes after operation starts.				
		0125	Stops automatically 625 minutes after operation starts.				

Item code	Item	Setting data		
		No.	Description	
1b (1B)	Forced thermostat ON	0000	5 minutes	
		0001	4 minutes	
1c	Cooling discharge temperature shift	-010	-10°C	
		-009	-9°C	
		-008	-8°C	
		}	}	
		0010	10°C	
1d	Heating discharge temperature shift	-010	-10°C	
		-009	-9°C	
		-008	-8°C	
		}	}	
		0010	10°C	
1e	Temperature shift for cooling/heating change in auto heat/cool mode	0001	± 1°C	
		0002	± 2°C	
		0003	± 3°C	
		}	}	
		0007	± 7°C	
1f (Upper limit) 20 (Lower limit)	Change to remote control temperature setting range	Cooling	0018	18°C (Lower limit at shipment)
			0019	19°C
			}	}
			0029	29°C
			0030	30°C (Upper limit at shipment)
21 (Upper limit) 22 (Lower limit)		Heating	0016	16°C (Lower limit at shipment)
			0017	17°C
			}	}
			0029	29°C
			0030	30°C (Upper limit at shipment)
23 (Upper limit) 24 (Lower limit)		Drying	0018	18°C (Lower limit at shipment)
			0019	19°C
			}	}
			0029	29°C
			0030	30°C (Upper limit at shipment)
25 (Upper limit) 26 (Lower limit)		Auto heat/cool	0017	17°C (Lower limit at shipment)
			0018	18°C
			}	}
			0026	26°C
			0027	27°C (Upper limit at shipment)
29		Humidifier operation	0000	Normal
			0001	Ignore heat exchanger temperature conditions.
2A		Filter (CN70) input switching	0000	Filter input (differential pressure switch input)
			0001	Alarm input (for trouble input about air cleaner or similar device)
			0002	Humidifier input (Operates linked with drain pump when humidifier is ON.)
2c	Indoor unit electronic control valve	0000	None	
		0002	Present (Setting at shipment)	
2E	T10 terminal switching	0000	Normal (Used as optional relay PCB or JEMA standard HA terminal.)	
		0001	Used for OFF reminder	
		0002	Fire prevention input	

Item code	Item	Setting data	
		No.	Description
2F	Automatic drain pump operation	0000	No forced operation
		0001	Forced operation for 1 minute
		}	}
		0060	Continuous operation
31	Ventilation fan operation	0000	None
		0001	Ventilation fan operated by remote controller.
32	Wired remote controller sensor	0000	Not used. (Body sensor is used.)
		0001	Remote controller sensor is used.
34	"Operation change control in progress" display	0000	Normal (displayed)
		0001	Not displayed
35	OFF reminder function for when weekly timer is used	0000	None
		0001	Only stop time setting is enabled.
3C	Heat exchanger temperature for cold air discharge (Heat exchanger control point for control to prevent cold air)	0013	Control temperature 13°C
		0014	Control temperature 14°C
		}	}
		0025	Control temperature 25°C
		0026	Control temperature 26°C
3d	Fan output switching	0000	Output linked with fan. (ON when indoor unit fan is operating.)
		0001	Fan mode operation output
3E	Drain pump delayed stop time	0000	No delayed stop
		0001	1 min. delayed stop
		0002	2 min. delayed stop
		}	}
		0058	58 min. delayed stop
		0059	59 min. delayed stop
		0060	60 min. delayed stop
45	Flap operation mode	0000	Standard setting
		0001	Draft reduction mode (Flap lower-limit position is shifted upwards.)
46	Flap swing mode	0000	Smudging reduction mode (Flap swing upper-limit position is shifted downwards.)
		0001	Normal mode
		0002	Draft reduction mode (Flap swing lower-limit position is shifted upwards.)

(Continued)

Item code	Item	Setting data		
		No.	Description	
5d	Fan tap setting (External static pressure of the rated air flow volume)	0001	75Pa (Setting at shipment)	Type E3
		0002	Type 200: 120Pa, Type 250: 130Pa	
		0003	Type 200: 180Pa, Type 250: 200Pa	
	Fan tap setting (Fan tap change in order to prevent drop in air discharge caused by filter installation)	Purpose		Type U2
		0000	Standard (Setting at shipment)	
		0001	High ceiling setting 1 (with standard, ECONAVI panel)	
Air-flow blocking kit (when a duct is connected.) Air-flow blocking kit (for 3-way air flow)				
0003	High ceiling setting 2 (with standard, ECONAVI panel)			
0006	Air-flow blocking kit (for 2-way air flow)			
5F	Repeat timer switching	0000	Function disabled	
		0001	Function enabled	
60	Timer function change prohibit	0000	Function disabled	
		0001	Function enabled	
62	Smudging control	0000	No smudging control	

NOTE

- Consider the device purpose and type when changing the settings. Incorrect settings may result in malfunction.
- Do not change any setting data that does not appear in this list.

7-5. Simple Setting Items

Item code	Item	Description
01	Filter sign ON time setting (filter lifetime)	Changes the indoor unit filter lifetime when a high-performance filter or other optional product is installed.
02	Degree of filter fouling	Reduces the filter sign ON time to 1/2 of the standard time (setting at the time of shipping) for cases when filter fouling is more severe than normal.

Filter sign ON times for each model

Model data	Model	Filter sign ON time			
		Standard		Long-life	
		Standard	High fouling	Standard	High fouling
0001	4-Way Cassette (U2)	x	x	2500	1250
0006	High Static Pressure Ducted (E3)	x	x	x	x

NOTE

- x indicates that there is no corresponding filter.
- High fouling: Set when **0001** is selected for the degree of filter fouling (item code **02**).

Item code	Item	Description
03	Central control address	Set when using a central control device. Used when setting the central control address manually from the remote controller.
04	Operating mode priority change	Note (1)

NOTE

There are other methods to avoid control in which the mode selected first takes priority.

Methods of remotely controlling the operating mode

- (1) Use the central functions of a central control device.
- (2) Use a remote control relay PCB at the outdoor unit.

When the operating mode at the priority remote controller is changed, the operating modes of other remote controllers change as shown below.

Mode change at priority remote controller		Operating modes at other remote controllers	
Current mode	New mode	Current mode	New mode
Cooling or dry	Heating	Cooling or dry	Heating
		Fan	Fan (not changed)
Heating	Cooling	Heating	Cooling
		Fan	Fan (not changed)
Cooling	Dry	Cooling	Cooling (not changed)
		Dry	Dry (not changed)
Heating	Dry	Heating	Cooling
		Fan	Fan (not changed)
Cooling or dry	Fan	Cooling	Cooling (not changed)
		Dry	Dry (not changed)
		Fan	Fan (not changed)
Heating	Fan	Heating	Heating (not changed)
		Fan	Fan (not changed)

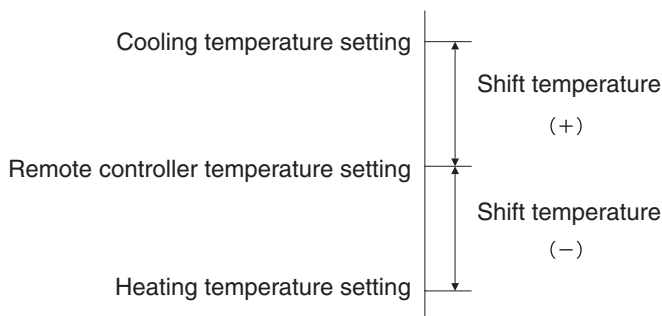
Item code	Item	Description
05	Fan speed setting when heating thermostat is OFF	Changes the fan speed setting when the heating thermostat is OFF.
06	Heating intake temperature shift	Shifts the intake temperature during heating. Can be set when the body thermostat is used.
07	Electric heater installation	Set when cost distribution is performed using an AMY central control system or similar system, and when an optional electric heater is installed. (This is unrelated to control of the electric heater.)
08	Humidifying when heater thermostat is OFF	Normally humidifying does not occur when the thermostat is OFF during heating operation. However, this setting can be changed in order to increase the amount of humidifying. Caution: In order to avoid water leakage and damage to the fan, do not use this setting unless a vaporizing humidifier is used.
0D	Permit/prohibit automatic heating/cooling	This setting can be used to prevent the automatic heating/cooling display on the remote controller if the unit configuration permits automatic heating/cooling operation.
0F	Cooling-only	This setting allows a heat pump indoor unit to be operated as a cooling-only unit.

NOTE

- In order to avoid water leakage and damage to the fan, do not set for humidifying when the thermostat is OFF unless a vaporizing humidifier is used.
- Consider the device purpose and type when changing the settings. Incorrect settings may result in malfunction.
- Do not change any setting data that does not appear in this list.

7-6. Detailed Setting Items

Item code	Item	Description
10	Unit type	Set when the indoor unit EEPROM memory is replaced during servicing.
11	Indoor unit capacity	
12	System (outdoor unit) address	These are not set at the time of shipping from the factory.
13	Indoor unit address	These must be set after installation if automatic address setting is not performed.
14	Group address	
17	Cooling intake temperature shift	Shifts the intake temperature during cooling and dry operation. (Enabled only when the body thermostat is used.) Increase this value when it is difficult to turn the thermostat ON.
18	Automatic stop time after operation start	The time at which an indoor unit is automatically stopped after operation starts can be set in increments of 5 minutes.
1b	Forced thermostat ON time	Use this setting to change the time for forced operation at installation or servicing from 5 minutes to 4 minutes.
1E	Temperature shift for cooling / heating change in "auto heat / cool" mode	"Auto heat / cool" selects the operating mode automatically based on the difference between the room temperature and the temperature set on the remote controller. This setting establishes a shift temperature for the heating / cooling temperature setting relative to the remote controller temperature setting.



Item code	Item	Description	
1F (Upper limit) 20 (Lower limit)	Change to the remote control temperature setting range	This setting changes the temperature range (upper limit and lower limit) which is set from the remote controller or central control device. The set upper limit must be greater than or equal to the lower limit. If the temperature setting is to be a single point, set the upper limit and lower limit to the same temperature.	
21 (Upper limit) 22 (Lower limit)			Cooling
23 (Upper limit) 24 (Lower limit)			Heating
25 (Upper limit) 26 (Lower limit)			Drying
			Auto heat/cool
2A	Filter input switching	This setting switches the filter input according to the purpose of use.	
2C	Indoor unit electronic control valve	This setting indicates whether or not an indoor unit electronic control valve is present. At the time of shipping, this setting is set according to the conditions of the indoor unit.	
2E	T10 terminal input switching	Ordinarily, the T10 terminal is used as the HA terminal at the time of shipping. However, this setting is used when the T10 terminal is used for OFF reminder or for fire prevention input.	
31	Ventilation fan operation from remote controller	It is possible to install a ventilation fan in the system, which can be started and stopped by the wired remote controller. The ventilation fan can operate linked with the start and stop of the indoor unit, or can be operated even when the indoor unit is stopped. Use a ventilation fan that can accept the no-voltage A contact as the external input signal. In the case of group control, the fans are operated together. They cannot be operated individually.	
32	Switching to remote controller sensor	This setting is used to switch from the body sensor to the remote controller sensor. Check that "remote controller sensor" is displayed. Do not use this setting with models that do not include a remote controller sensor. Do not use this setting if both the body sensor and remote sensor are used.	
34	ON/OFF of "Operation change control in progress" display	In a MULTI system with multiple remote controllers, switching between heating and cooling is restricted, and "Operation change control in progress" is displayed. This setting is used to prevent this display from appearing. Refer to the item concerned with operating mode priorities.	
35	OFF reminder function for weekly timer	This setting switches the operation when the weekly timer is connected to the remote controller. This can be used to prevent cases in which the unit is accidentally left ON. There is no change when this setting is ON, however it is necessary to set the weekly timer ON time.	

(Continued)

(Continued from previous page)

Item code	Item	Description
3C	Heat exchanger temperature for cold air discharge	The heat exchanger temperature control point for prevention of cold air discharge during heating operation can be changed.
3d	Fan output switching	The indoor unit PCB optional output for the fan can be switched according to the purpose of use.
3E	Drain pump delayed stop time	The drain pump stops after the set time delay after cooling operation stops.
45	DC flap operation mode	Changes flap operation to draft reduction mode.
46	DC flap swing mode	Selects the swing operation mode for the flap.
5d	DC fan tap setting	Sets the DC fan tap according to the purpose of use. Change the settings data at the same time.
5F	Stop at time set for OFF timer after operation starts	This setting enables a function that stops operation when the amount of time set for the OFF timer has passed after remote controller operation was started.
60	Timer function change prohibit	This function prohibits changes from being made to the remote controller time setting.
62	Smudging control	Smudging control is disabled when 0000 is set.

NOTE

- Consider the device purpose and type when changing the settings. Incorrect settings may result in malfunction.
- Do not change any setting data that does not appear in this list.

■ DC Fan Tap Change Procedure

<Procedure>

It is necessary to set the fan speed in accordance with the intended application and the optional parts to be used if any such part is used. (Table 1)

If this speed is not changed, a reduction in the air flow may result, causing the air outlet temperature to drop and condensation to form during cooling.

There are two ways to set the fan speed: either (1) change the positions of the DIP switches on the indoor unit control PCB or (2) set the speed using the wired remote controller. Select one of these ways.

* Priority is given to setting the fan speed by changing the positions of the DIP switches.

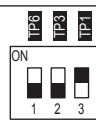
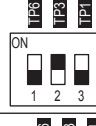

(Table. 1) DC fan motor tap setting table

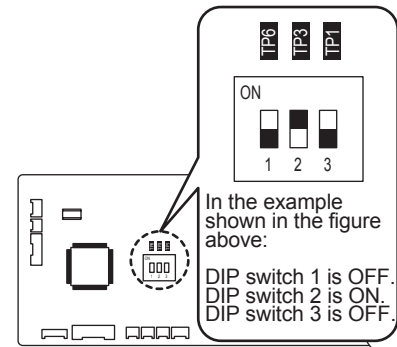
Setting No	Item code 5D/5d setting data	Intended application / name of optional parts	Setting No	Item code 5D/5d setting data	Intended application / name of optional parts
	0000	Standard (factory setting)	(1)	0001	Air-flow blocking kit (for 3-way air flow)
(1)	0001	High-ceiling setting 1 (with standard, ECONAVI panel)	(3)	0003	High-ceiling setting 2 (with standard, ECONAVI panel)
		Air-flow blocking kit (when a duct is connected.)	(6)	0006	Air-flow blocking kit (for 2-way air flow)

(1) When setting the fan speed by changing the positions of the DIP switches on the indoor unit control PCB

<Procedure> Be absolutely sure to turn off the power (earth-leakage circuit breaker).

- <1> On Table 1, check out the "Setting No." that corresponds to the intended application and the optional parts to be used.
- <2> Open the cover of the electrical parts box, and check the indoor unit control PCB. (Fig. 7-5)
- <3> Select the Setting No. which was checked out on Table 1, and change the positions of the DIP switches on the indoor unit control PCB.

Setting No.	DIP switch
(1)	 DIP switch "ON" position "OFF" position
(3)	 DIP switch "ON" position "OFF" position
(6)	 DIP switch "ON" position "OFF" position


























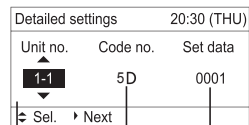
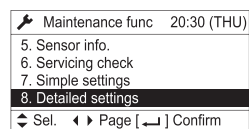
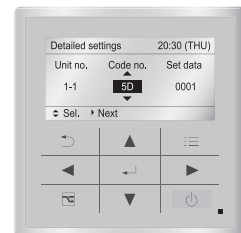
(Fig. 7-5)
Indoor unit control PCB

(2) When setting the fan speed using a wired remote controller (optional parts: CZ-RTC5B)

On Table 1, check out the "Item code 5D setting data" that corresponds to the intended application and the optional parts to be used.

<Procedure> Ensure that the unit has stopped operating before changing the fan speed.

- <1> Hold down the  +  +  buttons together for at least 4 seconds. The maintenance function screen is displayed.
- <2> Use the  /  buttons to select the display and the  /  buttons to select the page.
Select "8.Detailed settings" and press the  button. The [Detailed settings screen] appears.
Using the  /  buttons, select the unit No.
- <3> Using the  /  buttons, select the item code.
Using the  /  buttons, change the item code to "5D."
- <4> Using the  /  buttons, select the setting data.
Using the  /  buttons, change the setting data to the value checked out on Table 1, and press the  button.
- <5> After selecting the unit No. using the  /  buttons, press the  button. The [Detailed settings completion screen] appears. Select "Yes", and press the  button.














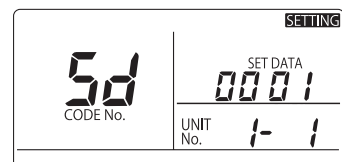
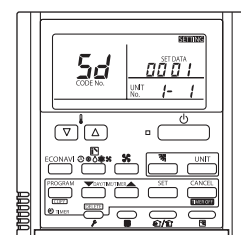
Unit No. Setting data
Item code

(3) When setting the fan speed using a wired remote controller (optional parts: CZ-RTC4)

On Table 1, check out the "Item code 5d setting data" that corresponds to the intended application and the optional parts to be used.

<Procedure> Ensure that the units have stopped operating before changing the fan speed.

- <1> Hold down the  +  +  buttons together for at least 4 seconds.
- <2> Each time the  button is pressed, the numbers of the indoor units under group control are displayed in sequence.
The fan motor of only the indoor unit that has been selected will run.
- <3> Specify item code "5d" using the temperature setting () / () buttons.
- <4> Change the setting data using the hour   buttons. The setting data details are as given on Table 1.
- <5> Press the  button. (OK if the display changes from flashing to lighted.)
- <6> Press the  button. The normal stop status is established.
Go to step <2> to change the selected indoor unit.
- <7> Press the  button. The normal stop status is established.



7-7. Remote Controller Servicing Functions

- The remote controller includes a number of servicing functions. Use these as needed for test runs and inspections.

■ Timer Remote Controller CZ-RTC4

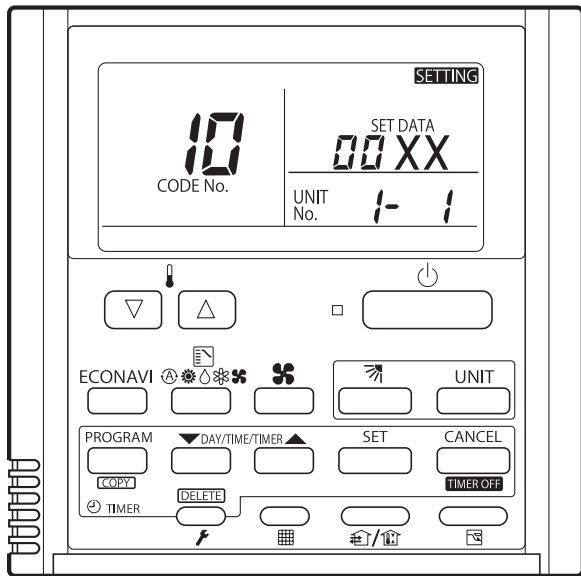









Fig. 7-6

List of Servicing Functions

Functions	Description	Button operation	Reset operation	Unit status
Test run	Operation with forced thermostat ON	Press and hold the button for 4 seconds or longer.	Press the button.	Current operation is maintained.
Sensor temperature display	Temperature display from each sensor	Press and hold the and buttons for 4 seconds or longer.		
Servicing check display	Alarm history display	Press and hold the and buttons for 4 seconds or longer.		
Simple settings	Filter lifetime, operating mode priority, central control address, and other settings	Press and hold the and buttons for 4 seconds or longer.	Automatic reset	When settings are made from a remote controller, the indoor unit where that remote controller is connected stops.
Detailed settings	System address, indoor unit address, central control address, and other settings	Press and hold the , and buttons for 4 seconds or longer.		
Automatic address	Automatic address setting based on command from the wired remote controller	Press and hold the and the timer operation buttons for 4 seconds or longer.	Press the button.	Entire system stops.
Address change	Change of indoor unit address	Press and hold the and the timer operation buttons for 4 seconds or longer.		

■ High-spec Wired Remote Controller CZ-RTC5B

Display of "maintenance function" screen

- ① Keep pressing the ,  and  buttons simultaneously for 4 or more seconds.
The "Maintenance func" screen appears on the LCD display.
- ② Press the  or  button to see each menu.
If you wish to see the next screen instantly, press the  or  button.

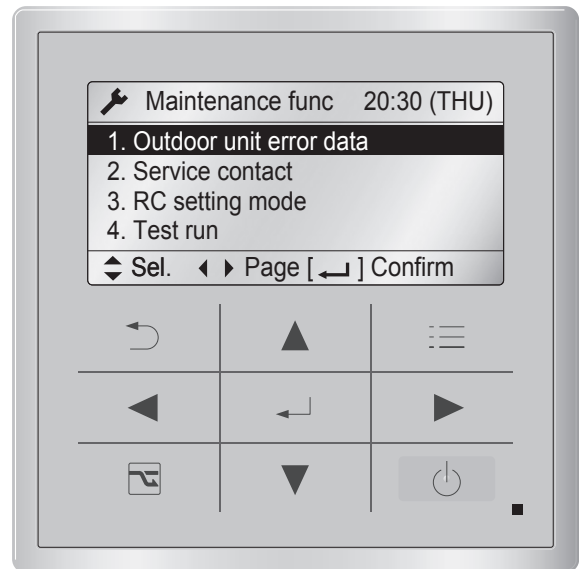









Fig. 7-7

 Maintenance func 20:30 (THU) 0. ECONAVI info. 1. Outdoor unit error data 2. Service contact 3. RC setting mode Sel. Page [←] Confirm	 Maintenance func 20:30 (THU) 4. Test run 5. Sensor info. 6. Servicing check 7. Simple settings Sel. Page [←] Confirm	 Maintenance func 20:30 (THU) 8. Detailed settings 9. Auto address 10. Set elec. consumption 11. Set touch key Sel. Page [←] Confirm	 Maintenance func 20:30 (THU) 12. Check touch key 13. nanoe X 14. Initialize controller 15. datanavi Sel. Page [←] Confirm
--	--	---	---

Maintenance function screen



List of Servicing Functions

Functions	Description	Menu selection	Reset operation	Unit status
ECONAVI • CZ-KPU3A • CZ-CENSC1	Display from each sensor	0. ECONAVI info.	Press the  button.	
Test run	Operation with forced thermostat ON	4. Test run		
Sensor temperature display	Temperature display from each sensor	5. Sensor info		
Servicing check display	Alarm history display	6. Service check	Press the  button. (Restart)	When settings are made from a remote controller, the indoor unit where that remote controller is connected stops.
Simple settings	Filter lifetime, operating mode priority, central control address, and other settings	7. Simple settings		
Detailed settings	System address, indoor unit address, central control address, and other settings	8. Detailed settings		
Automatic address	Automatic address setting based on command from the wired remote controller	9. Auto address	Automatic reset	Entire system stops.
nanoe™ X (CZ-RTC5B only)	Display status of nanoe™ X	13. nanoe X	Press the  button.	

7-8. Test Run Function

Operates the unit with the thermostat forced ON.


<Procedure of CZ-RTC4>

- (1) Press and hold the  button for 4 seconds or longer.
- (2) "TEST" appears on the remote controller LCD display (Fig. 7-8).
- (3) Press the  button to start the test run.

- The temperature cannot be adjusted in Test Run mode. (This mode places a heavy load on the machines. Therefore use it only when performing the test run.)
- The test run can be performed using the HEAT, COOL, or FAN operation modes.

NOTE

The outdoor units will not operate for approximately 3 minutes after the power is turned ON and after operation is stopped.

- If correct operation is not possible, an error code is displayed on the remote controller LCD display.
- (4) Press the  button to return to normal remote controller display.
 - To prevent continuous test runs, this remote controller includes a timer function that cancels the test run after 60 minutes.
 - The operation is possible even if the cassette-type ceiling panel has not been installed. ("P09" display does not occur.)

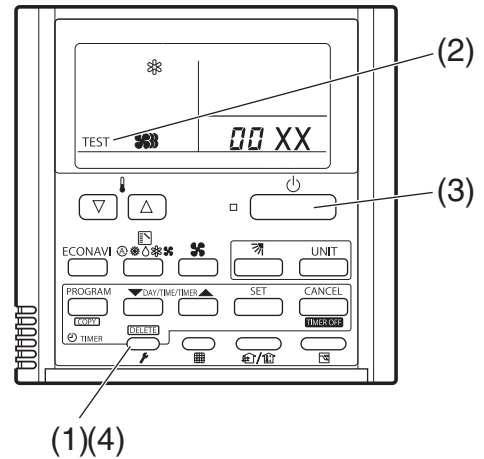



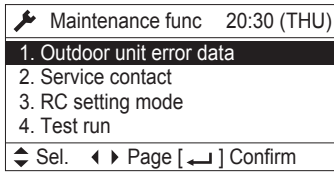







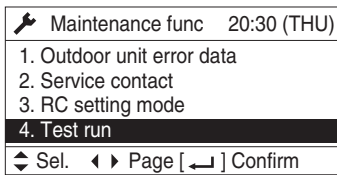
Fig. 7-8




<Procedure of CZ-RTC5B>

- ① Keep pressing the ,  and  buttons simultaneously for 4 or more seconds. The "Maintenance func" screen appears on the LCD display.



- ② Press the  or  button to see each menu. If you wish to see the next screen instantly, press the  or  button. Select "4. Test run" on the LCD display and press the  button.



Change the display from OFF to ON by pressing the  or  button. Then press the  button.

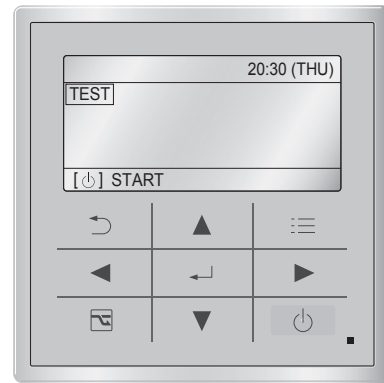
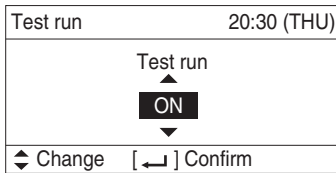

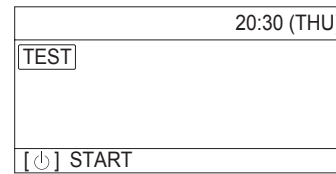

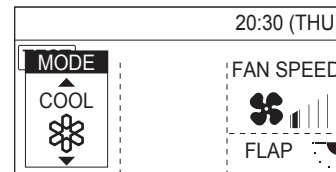


Fig. 7-9

- ③ Press the  button. "TEST" will be displayed on the LCD display.









- ④ Press the  button. Test run will be started. Test run setting mode screen appears on the LCD display.



■ Sensor Temperature Display Function (displayed regardless of whether unit is operating or stopped)

The procedure below display the sensor temperatures from the remote controller, indoor unit, and outdoor unit on the remote controller.

<Procedure of CZ-RTC4>

- (1) Press and hold the  and  buttons simultaneously for 4 seconds or longer.
- (2) The unit No. "X-X" (main unit No.), item code "XX" (sensor address), and servicing monitor "00 YY" (sensor temperature) are displayed on the remote controller LCD display. (See Fig. 7-10 at right.)
- (3) Press the temperature setting  /  buttons and select the item code to the address of the sensor to monitor.
- (4) If group control is in effect, press the  button to select the unit to monitor.
Press the temperature setting buttons to select the item code to change.
- (5) Press the  button to return to normal remote controller display.

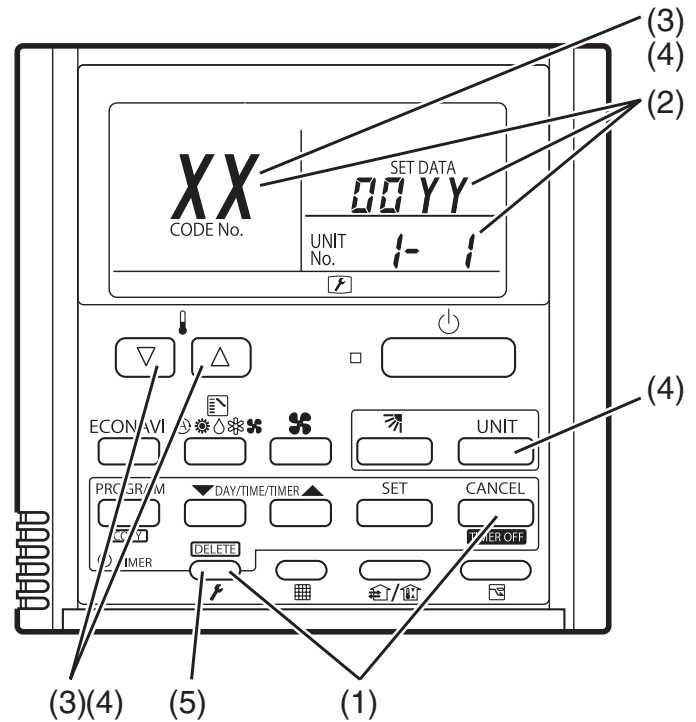


Fig. 7-10

NOTE




The temperature display appears as "- - -" for units that are not connected.

* If monitor mode is engaged while normal operation is in progress, only the parts of the LCD display shown in the figure will change. Other parts continue to display the same information as during normal operation.






	Item code	Meaning of Code
Indoor unit data	02	Indoor unit intake temp.
	03	Indoor unit heat exchanger temp. (E1)
	04	Indoor unit heat exchanger temp. (E2)
	05	—
	06	—
	07	—
	08	—
	09	—
	Outdoor unit data	0A
0b		—
0C		—
0d		Intake temp. (TS)
0E		Outdoor unit heat exchanger temp. (C1)
0F		Outdoor unit heat exchanger temp. (C2)
10		—
11		Outdoor air temp. (TO)
12		—
13		Current value (CTL2)
14		Current value (CTL1)
15		Outdoor MV value (MOV1)
16		—
19	Frequency	

* Depending on the model, some items may not be displayed.



<Procedure of CZ-RTC5B>



- ① Keep pressing the ,  and  buttons simultaneously for 4 or more seconds. The "Maintenance func" screen appears on the LCD display.

Maintenance func		20:30 (THU)
1. Outdoor unit error data		
2. Service contact		
3. RC setting mode		
4. Test run		
Sel.		Page [Left Arrow] Confirm

- ② Press the  or  button to see each menu. If you wish to see the next screen instantly, press the  or  button. Select "5. Sensor info." on the LCD display and press the  button.



Maintenance func		20:30 (THU)
5. Sensor info.		
6. Servicing check		
7. Simple settings		
8. Detailed settings		
Sel.		Page [Left Arrow] Confirm

Select the "Unit no." by pressing the  or  button for changes.

Sensor info.		20:30 (THU)
Unit no.	Code no.	Data
	00	0026
1-1	01	0028
	02	0026
Sel.		Next

Then press the  button. Display sensor information of the unit.

Sensor info.		20:30 (THU)
Unit no.	Code no.	Data
1-1	00	0026
	01	0028
	02	0026
Scroll		

Refer the information by pressing the  or  button.

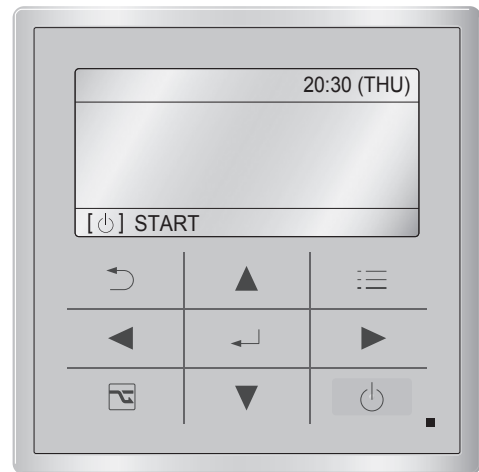














Fig. 7-11

■ Automatic address setting






<Procedure of CZ-RTC5B>

- Keep pressing the ,  and  buttons simultaneously for 4 or more seconds. The "Maintenance func" screen appears on the LCD display.
- Press the  or  button to see each menu. If you wish to see the next screen instantly, press the  or  button. Select "9. Auto address" on the LCD display and press the  button.

 Maintenance func	20:30 (THU)
9. Auto address	
10. Set elec. consumption	
11. Set touch key	
12. Check touch key	
◆ Sel. ◀ ▶ Page [] Confirm	

- The "Auto address" screen appears on the LCD display. Change the "Code no." to "A1" by pressing the  or  button.

Auto address	20:30 (THU)
Code no.	O/D unit no.
A1	1
◆ Sel. ▶ Next	

- Select the "O/D unit no." by pressing the  or  button. Select one of the "O/D unit no." for automatic address by pressing the  or  button. Then press the  button. Approximately about 10 minutes are required. When automatic address setting is completed, the units return to normal stopped status.

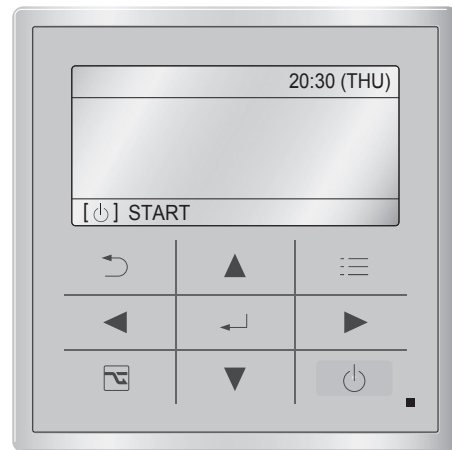














Fig. 7-12

■ Checking indoor unit addresses



- Keep pressing the ,  and  buttons simultaneously for 4 or more seconds. The "Maintenance func" screen appears on the LCD display.

 Maintenance func	20:30 (THU)
1. Outdoor unit error data	
2. Service contact	
3. RC setting mode	
4. Test run	
◆ Sel. ◀ ▶ Page [] Confirm	

- Press the  or  button to see each menu. If you wish to see the next screen instantly, press the  or  button. Select "7. Simple settings" on the LCD display and press the  button.

 Maintenance func	20:30 (THU)
5. Sensor info.	
6. Servicing check	
7. Simple settings	
8. Detailed settings	
◆ Sel. ◀ ▶ Page [] Confirm	

The "Simple settings" screen appears on the LCD display.

Select the "Unit no." by pressing the  or  button for changes.





Simple settings	20:30 (THU)	
Unit no.	Code no.	Set data
1-1	01	0001
◆ Sel. ▶ Next		

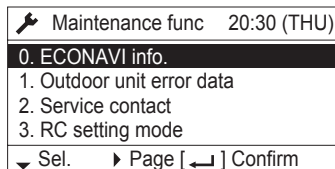
The indoor unit fan operates only at the selected indoor unit.

■ Check of ECONAVI Operational Status


The status of ECONAVI operation can be checked instantly.
It is available to check the operation when installing the indoor unit.

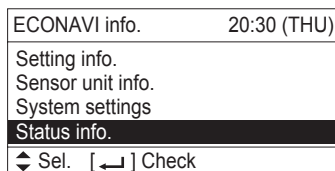
<Procedure of CZ-RTC5B>

- Keep pressing the ,  and  buttons simultaneously for 4 or more seconds.
The "Maintenance func" screen appears on the LCD display.
- Select "0. ECONAVI info." on the LCD display and press the  button.



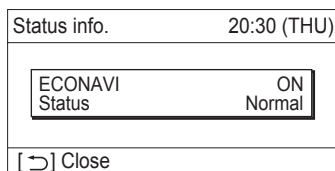
- Press the  or  button to see each menu.

Select "Status info." on the LCD display and press the  button.



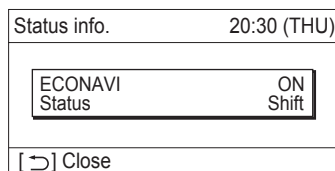
- There are four patterns of operational status display as shown below.

(1) Under normal operation



State of no energy-saving operation

(2) Under temperature shift



State of energy-saving (temperature shift) operation

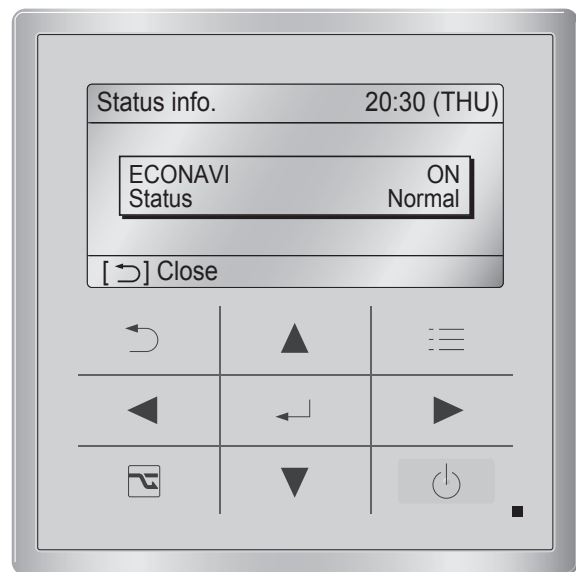
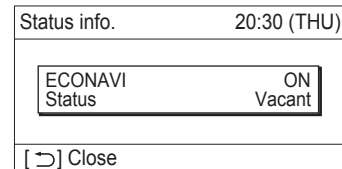


Fig. 7-13

(3) Under suspension with absentee

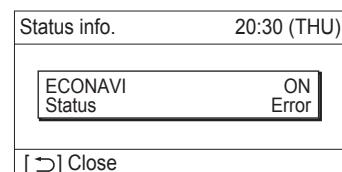


State of energy-saving (suspended) operation

*Shows that air conditioner operation was suspended because no person was detected for a certain period.


This state remains until operation is restarted.

(4) Under sensor communication error



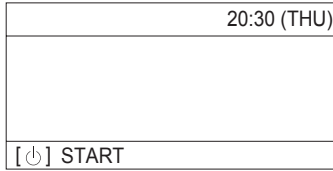
Shows that the connected ECONAVI sensor is in error state.

■ nanoe™ X Display

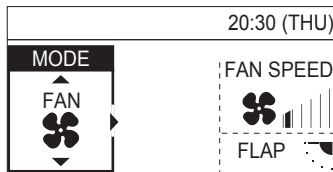
When the  appears on the remote controller (CZ-RTC5B), the status of the nanoe™ X can be checked in the following way.




<Procedure of CZ-RTC5B>

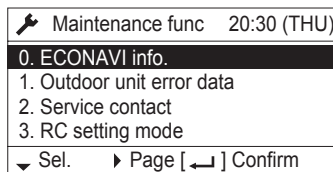
- ① Switch On the earth leakage circuit breaker.
- ② Wait until the remote control display returns to normal.






- ③ Operate the unit in FAN mode.



- ④ While operating in FAN mode (more than 5 minutes have elapsed), press the ,  and  buttons simultaneously for 4 or more seconds. The "Maintenance func" screen appears on the LCD display.



- ⑤ Press the  or  button to see each menu. Select "13. nanoe X" on the LCD display and press the  button.

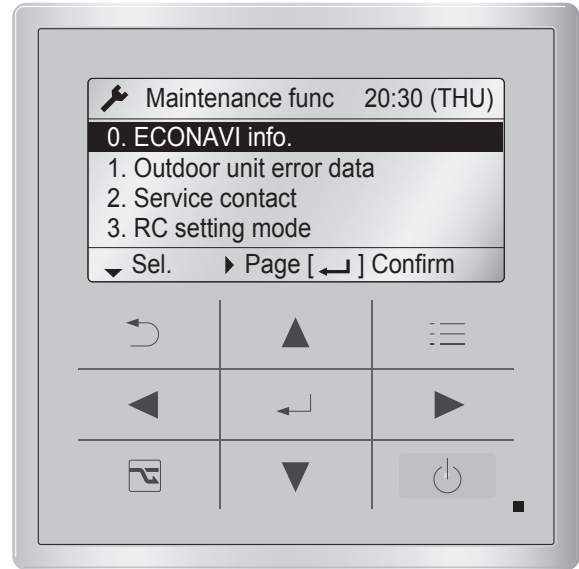
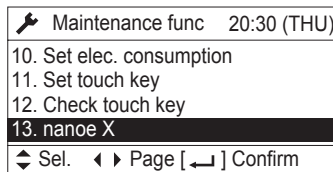




Fig. 7-14

- ⑥ Check that the nanoe™ X module status is "Normal". The indoor unit on the display can be scrolled up or down using  /  buttons.

nanoe X		20:30 (THU)
Unit no.	Status	
1- 1	Normal	
1- 2	Not connected	
1- 3	Unsupported	
▼ Scroll		

The nanoe™ X module status of all indoor units will be displayed.

Normal : The nanoe™ X module is operating normally.

Unsupported : The indoor unit is not available to the nanoe™ X function.

*1-1 and 1-2 represent the unit number.

*In the case of "Unsupported", select "8. Detailed settings" and check the setting data of the Code no. 9.

*If the setting data is "0000", the nanoe™ X module is not recognized. Check the status of the connection.

If the display other than "Normal" or "Unsupported" appears, check the Step ⑦ next page.

⑦ In the case of the nanoe™ X module status other than “Normal” or “Unsupported”



If the menu “13. nanoe X” is not displayed or the module status becomes other than “Normal” or “Unsupported” even though the nanoe™ X module is connected, there is a probability that the following symptoms happen.

Display	Symptom	Countermeasure
Discharge error	The probability of occurrence of nanoe™ X is deviated from the room temperature and humidity conditions. Outside the range of temperature: Below 5°C or over 35°C Outside the range of humidity: Over 86%	There is no abnormality in the nanoe™ X module. Use in the range of appropriate temperature and humidity.
Humidity error	Humidity sensor not connected or sensor failure	Check if connected to the indoor unit PCB of the humidity sensor or replace the sensor.
Faulty connection	The wiring between the indoor unit and nanoe™ X module is not connected.	Specialize the target indoor unit and check the connection to the indoor unit PCB of the nanoe™ X module.
Not connected	There is no abnormality in the nanoe™ X module. Use in the range of appropriate room temperature and humidity.	

*Specialization of the indoor unit can be checked by the operation of the airflow.

Checking method:

1. Stop the maintenance function.

Press the  button to show the maintenance func display. Then press the  button.

2. Operate the airflow.

Select the Unit no. under the  “2. Airflow setting”. Make the airflow setting.

The unit which is corresponded to the preset flap operation will become the target unit.

When the unit is specialized, switch off the earth leakage circuit breaker and unplug the connector of the nanoe™ X module wiring from the PCB. Then plug it in again. Switch on the earth leakage circuit breaker and once again check the Steps 1 to 3. Then check the status by selecting the menu “13. nanoe X”. If “Disconnection failure” or “Not connected” appears on the display, it is necessary to replace the nanoe™ X module with a new one.

8. HOW TO INSTALL THE WIRELESS REMOTE CONTROLLER RECEIVER

■ Important Safety Instructions	8-2
■ Optional Controller (Remote Controller)	8-3
8-1. Names and Operations	8-3
8-2. Installing Batteries	8-5
8-3. Setting the Current Time	8-5
8-4. Operation	8-6
8-5. Timer Operation	8-7
8-6. Lock Individual Flap	8-8
8-7. Operating Multiple In/Outdoor Units Simultaneously (Group Control)	8-8
8-8. Using the Remote Controller	8-9
8-9. Pairing Addresses	8-9
8-10. Emergency Operation	8-11
8-11. Miscellaneous Settings	8-12
8-12. Button Control	8-12
8-13. nanoe™ X Setting	8-13
8-14. ECONAVI Setting	8-13
8-15. Ventilation Setting	8-13
8-16. Energy Saving Setting	8-13
8-17. Temperature Automatic Return	8-14
8-18. Troubleshooting	8-15
■ Optional Controller (Remote Controller)	8-16
8-19. Names and Functions	8-16
8-20. Installing Batteries	8-18
8-21. Setting the Current Time	8-18
8-22. Operation	8-19
8-23. Timer Operation	8-20
8-24. Adjusting the Wind Direction	8-21
8-25. Operating Multiple In/Outdoor Units Simultaneously (Group Control)	8-21
8-26. Using the Remote Controller	8-22
8-27. For Best Results	8-22
8-28. Addresses	8-22
8-29. Emergency Operation	8-24
8-30. Miscellaneous Settings	8-25
8-31. Before Requesting Service	8-26
■ Wiring for the Receiver	8-27
8-32. Common to All Models	8-27
8-33. CZ-RWSU3, CZ-RWRU3	8-29
8-34. CZ-RWSC3, CZ-RWRC3	8-31
8-35. Common to All Models	8-35

■ Important Safety Instructions

WARNING

Installation Precautions

- Do not install yourself
Installation should always be performed by your dealer or a professional service provider.
Electric shock or fire may result if an inexperienced person performs any installation or wiring procedures incorrectly.
- Use only specified air conditioners
Always use only air conditions specified by the dealer.

Precautions for Use

- Do not touch switches with wet hands
Electric shock and damage to the system can result.
- Protect the remote controller from water
Damage to the system can result.
- Stop the system and turn the power off if you sense unusual smells or other irregularities
Continuing operation when the system is out of order can result in electric shock, fire, and damage to the system.
Contact your dealer.
- Do not swallow the battery.

Moving and Repair Precautions

- Do not repair
Never repair the system by yourself.
- Contact your dealer before moving the system
Contact your dealer or a professional service provider about moving and reinstalling the system.
Electric shock or fire may result if an inexperienced person performs any installation procedures incorrectly.
















■ Optional Controller (Remote Controller)

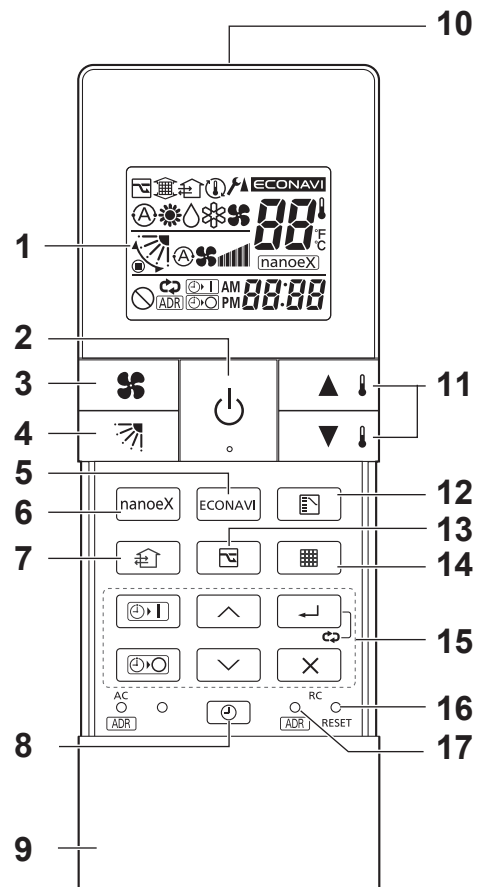
Wireless Remote Controller CZ-RWS3


1 remote controller can control a group of up to 8 indoor units. (See page 8-8)

8-1. Names and Operations

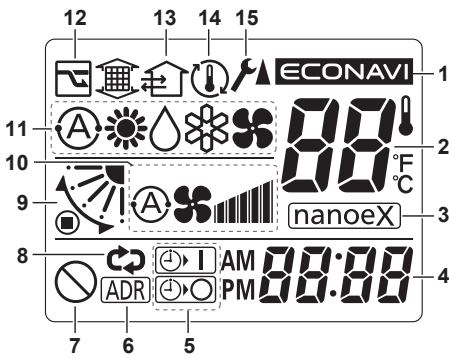
REMOTE CONTROLLER

1. Operation Display	Displays the operation status. (The figure shows all the statuses.)	14. Filter button 	Press to turn off the filter lamp on the receiver.
2. Start/Stop button 	Pressing this button once starts and pressing again stops the operation.	15. Timer setting buttons 	Use for operating with a timer.
3. Fan speed button 	Press to change the fan speed.	16. RC reset button 	Use this button after changing the batteries.
4. Flap button 	Press to change the flap direction.	17. RC address button 	Press to set addresses.
5. ECONAVI button 	Press to set ECONAVI.		
6. nanoe™ X button 	Press to set nanoe™ X.		
7. Ventilation button 	Use this when connected to an aftermarket fan.		
8. Clock button 	Use this to set the clock.		
9. Cover	Press at the top center and then slide down.		
10. Transmitter			
11. Temperature setting buttons	 raises the temperature setting 1 °C at a time.  lowers the temperature setting 1 °C at a time.		
12. Mode Select button 	Press to switch the operation mode.		
13. Energy saving button 	Press to enable or disable energy saving.		










From this page, the names of remote controller's buttons will be indicated with the above illustrations.
 E.g.: Start/Stop button → 

Screen display



- 1 Appears when ECONAVI is being set to ON.
- 2 Indicates the set temperature.

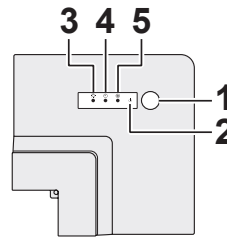
- 3 Appears when nanoe™ X is being set to ON.
- 4 Displays the present time.
- 5 Timer program indication
 : The indoor unit starts operation at the programmed time.
 : The indoor unit stops operation at the programmed time.
- 6 Indicates the remote controller addresses are set.
- 7 Appears when the function is not available.
- 8 The ON timer or the OFF timer will operate repeatedly every day.
- 9 Indicates the flap position.

- 10 Indicates the fan speed.
- 11 Displays the selected operation mode. (AUTO  / HEAT  / DRY  / COOL  / FAN )
- 12 Energy saving operation is in process.
- 13 Appears when a fan available in the market is installed and is operating.
- 14 “Temperature Automatic Return” is set.
- 15 Appears when the setting screen is displayed.

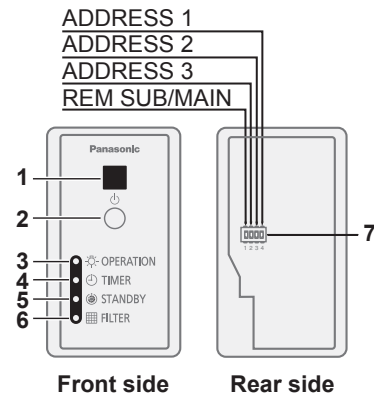
RECEIVER

1. Receiver	Receives the signal sent from the remote controller.
2. Emergency operation button	See page 8-11. Indicator lamps When an error occurs, one of the lamps flashes. When an indicator lamp is flashing, refer to “Troubleshooting”.
3. OPERATION lamp	Lights up when the unit is operating.
4. TIMER lamp	Lights up when the timer is set.
5. STANDBY lamp	The lamp in the HEAT mode lights up at the following times: during the startup, during the thermostat operation, and during the defrosting.
6. FILTER lamp	This lamp is for notifying you when the filter needs to be cleaned.
7. Address switch	See the section “8-9. Pairing Addresses” on page 8-9.





CZ-RWSU3 CZ-RWRU3



CZ-RWSC3 CZ-RWRC3



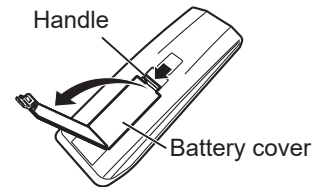
NOTE

- If a heat pump (2WAY) type is being used, it will beep twice and the operating lamp will light up on the display; if the timer and standby lamps blink alternately, a conflict between the heating and cooling exists, so the unit cannot operate in the desired mode. (On models that do not have an Auto function, even if Auto is selected, it works in the same way.)
- When the local operation is disabled by centralized control or similar cause, and if the Start/Stop , Mode  or Temperature setting button   is pressed, the unit will beep five times and the change will not be made.

8-2. Installing Batteries

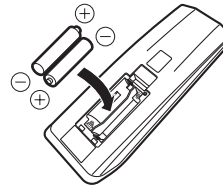
1. Remove the battery cover.

- Pinch the handle and open while pressing it towards the ▼ mark.



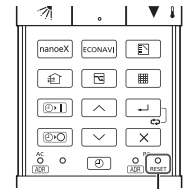
2. Insert two LR03 size batteries.

Put the batteries in with the polarity [+/-] as shown in the figure.



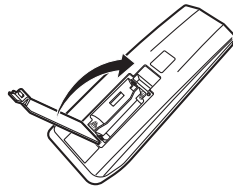
3. Gently insert one end of an unfolded paper clip (or a similar object that can fit) into the RC reset hole and press the RC reset button inside the hole.

- Take the batteries out and insert again if the time display is not “0:00” or “AM 12:00”.



RC reset button

4. Put the battery cover back on.



■ Notes on batteries

- The battery life is approximately 1 year.
- Reception may become poor or display on the remote controller fades when batteries are low.
- If the remote controller will not be used for a long period of time, remove the batteries. (In order to avoid a battery leak.)
- Emergency operations can be performed on the unit when the batteries run out. (See page 8-11)

■ Replacing batteries

- Replace both batteries at the same time with 2 LR03 size batteries.
- Do not use rechargeable batteries (NiCd, NiMH, etc.) because their size, shape, and some performance are different.
- Dispose of the old batteries at the designated sites in your community.
- The unit is restored with the factory setting when batteries are removed.
- After changing the batteries, reset the current time. (See Section “8-3. Setting the Current Time”)

8-3. Setting the Current Time

1. Press for 2 seconds or longer.

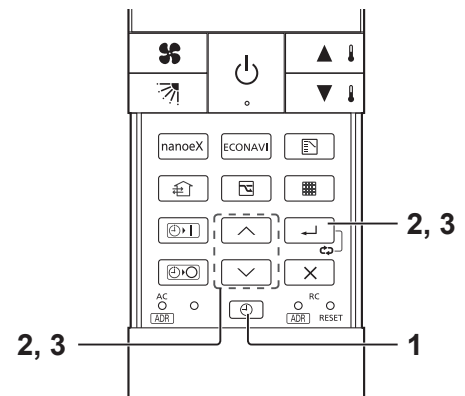
- The time display flashes. (The colon lights up.)

2. Press / to set the hour, then press .

3. Press / to set the minutes, then press .

Note

- If the buttons are not pressed for a certain duration while setting the time, the displayed time is set.
- Adjust the time periodically.









8-4. Operation

Hold the remote controller with your hand and point its transmitter at the receiver.










Power: Turn on the circuit breaker beforehand, referring to the operating instructions for the unit.

1. Press .





2. Press  to select the operation mode.

- Every time you press , it cycles from “Auto  → Heat  → Dry  → Cool  → Fan ”.
- Models that only provide the cooling function cannot operate in the Auto or Heat mode.
- The available functions differ depending on the indoor unit being used. See page 8-12 for how to change the operation mode display.

3. Press  to select the fan speed.











- Every time you press , it cycles from “ →  →  →  (Auto)”.
- Auto does not work in Fan mode.
- If the unit is not heating very effectively with a fan speed “”, switch the fan speed to “” or “”.
- The available functions differ depending on the indoor unit being used.
- “” is displayed if the function is not available.

4. Press  /  to set the temperature.

	MAX (°C)	MIN (°C)
Auto 	27	17
Heat 	30	16
Dry  / Cool 	30	18

- Temperature settings cannot be made in Fan mode.
- The temperature range that can be set varies depending on the model.
- The maximum temperature varies depending on the system and operating condition. See page 8-12 for how to change the maximum temperature.

5. Press  to select the flap direction.

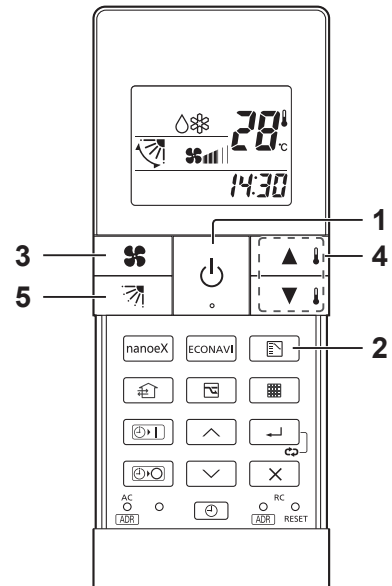
- Every time you press , it cycles from “ →  →  →  →  →  (Swing) →  (Stop)”.
- If you press  again while the flap is swinging, you can stop the flap from swinging and set it in place as desired.
- When the unit is in heating standby, the flap (up-down wind direction plate) faces upwards.
- The available functions differ depending on the indoor unit being used.
- “” is displayed if the function is not available.
- **Never try to manually move the flap (up-down wind direction plate) that is operated by the remote controller.**

Stop: Press .

- If you cannot turn the air conditioner off in the normal way, disconnect the power to the indoor unit and contact the dealer where the product was purchased.
- When the unit is stopped with the remote controller, the fan on the outdoor unit may continue to run for a while.

< Auto operation >

It heats or cools automatically via the differences between the set temperature and the room temperature. Auto operation is available only when identical refrigerant system inside all the indoor units or cooling/heating free-type are under control as 1 group. When using gas heat pump (GHP) air conditioners, contact the dealer where the product was purchased.





8-5. Timer Operation

- When setting the timer, make sure the current time on the remote controller is accurate.
- The timer's clock can only be set when the display of the remote controller is ON.
- After setting the timer, put the remote controller for in a place where its signal will reach the receiver of the indoor unit.



1. Press or twice.

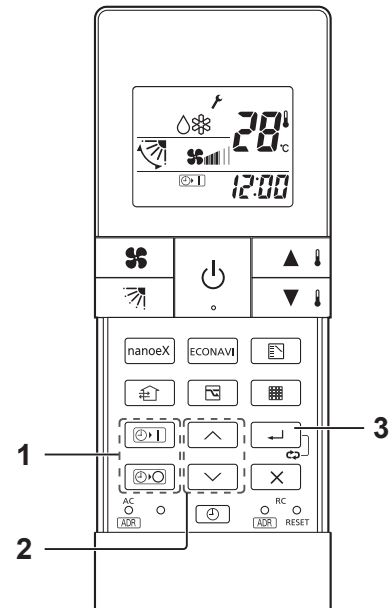
- The time last set on the timer starts blinking. (“- -: - -” blinks when the timer is not set or after replacing batteries.)

2. Press / to set the timer to the desired time.

- Every time you press  / , the time changes in 10 minute increments.
- If you press and hold the button, the time changes quickly.

3. Press .

- The timer display stops blinking and the display reverts to the current time after 3 seconds.
- “ / ” is displayed when set.



Combining ON and OFF Timers

1. The ON and OFF timers can be set respectively.

Checking the timer setting

1. Press or .




- The scheduled time is displayed for 4 seconds.
- When the timer is not set or after replacing batteries, it displays “- -: - -”. (Initial setting)

Changing a timer setting

1. Perform Step 1 to 3 noted above as you did when setting.


Canceling a timer setting

1. Press .

- If you wish to cancel the setting for either the  or the  timer, press  while the scheduled time is displayed.

Using the same timer setting every day

1. Press for 2 seconds or longer.

- “” is displayed when set.
- If you press  again for 2 seconds or longer, “” goes off and the timer operates only once.

8-6. Lock Individual Flap

(Supported models: 4-way ceiling cassette type)

You can set the flap for each air outlet individually according to the room condition.

- Even if the flap setting is changed with  (Page 8-6), the flap directions set here are not changed.





1. Press and at the same time for 4 seconds or longer.

- “” starts blinking and the setting screen is displayed.




2. Press / to select the indoor unit to set, then press .

- Every time you press / to switch between “U1 ↔ U2 ↔ ... ↔ U8 ↔ AL (All indoor units that are connected to the remote controller)”, the buzzer sounds from the corresponding receiver.
- When settable: 1 short beep
- When not settable*: 1 short beep followed by 1 long beep
- * When the indoor unit is not connected or does not support this function.



3. Press / to select the air outlet.

- Every time you press  / , it cycles from “F1 ↔ F2 ↔ F3 ↔ F4 ↔ AL (All the air outlets)”.
- The square mark (indented ) on the panel of the indoor unit indicates air outlet No. 1. There are some models that do not have a square mark (indented ).
- The air outlet No. changes according to the installation direction. Check by actual operation.


4. Press / to select the flap direction, then press .

- Every time you press  / , it cycles from “ (Unlock) ↔  (Swing) ↔  ↔  ↔  ↔ ”.

5. Press .

- You can return to Step 2 to continue setting if you press  instead of .

Note

- Press  to stop operation in the middle.

CZ-RWSC3

The available functions differ depending on the indoor unit being used.

The wind direction cannot be set via remote controller for any models other than those noted below.

For more information, please refer to the users' manual that came with your indoor unit.

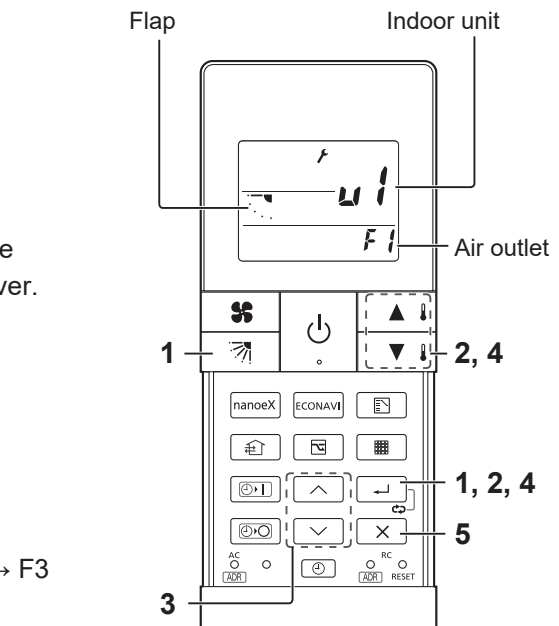
4-Way Cassette Models, Ceiling Models, Wall-Mounted Models


Please refer to *Setting the Wind Direction and Stopping Flap Swing*.

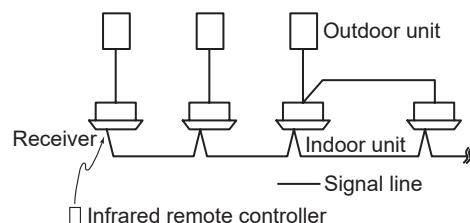
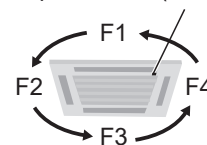
8-7. Operating Multiple In/Outdoor Units Simultaneously (Group Control)

Group control works well for providing air conditioning to 1 large room with more than 1 air conditioning units.

- 1 remote controller can operate up to 8 indoor units.
- All the indoor units have identical settings.
- Set temperature sensing to the indoor unit (Main sensor). (See page 8-3)



Square mark (indented )



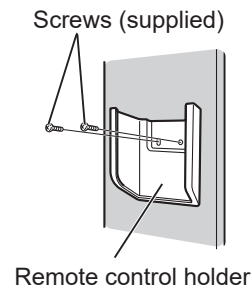
8-8. Using the Remote Controller

- Hold the remote controller with your hand and point its transmitter at the receiver. When the signal is received properly, it will beep.
- Signals can travel a direct distance of 6 metres. This distance should be used only as a guide. It depends on battery strength.
- Make sure nothing is between the remote controller and the receiver that could block the signal.
- Do not leave the remote controller in direct sunlight, where the wind from the air conditioner can blow directly on it, or near any other heat source.
- Take care not to drop, throw, or wash the remote controller with water.
- The signal from the remote controller may not be received in rooms with rapid start fluorescent lighting or inverter lights. For more information, please contact the dealer where the product was purchased.


Wall Mount Use

■ Mounting the holder

1. Fasten the remote control holder with screws.

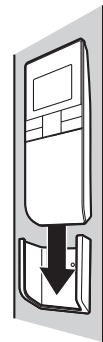


2. Slide the remote controller down into the holder.

- Press  from the location you wish to mount the remote controller and make sure the signal is received properly.

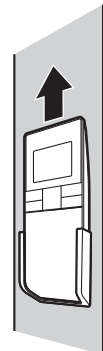
Note

- You cannot operate if the distance between the remote controller and the receiver is greater than that signals can travel.



■ Detaching the controller

1. Pull the remote controller up.



8-9. Pairing Addresses

When more than 1 indoor units are installed in the same room with a compatible remote controller, addresses can be set up to avoid crosstalk.

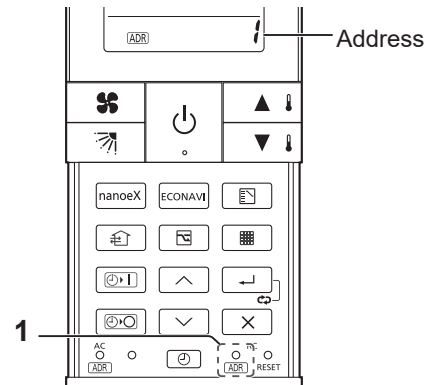
You can control up to 6 indoor units individually by the supported remote controller by pairing the address on the remote controller and the number on the address switch on the receiver.

There are separate address settings: receiver addresses for the receivers, and transmitter addresses for the remote controller. Units will not be controlled if the setting do not match.

Checking Addresses

1. Press  with one end of an unfolded paper clip (or a similar object that can fit).

- Its current address appears on the display for 5 seconds.
- If this address corresponds to the address of a receiver, the buzzer sounds. (If it is on ALL, the buzzer will always sound.)
- If it is on ALL, it can be operated regardless of receiver addresses. Point the remote controller at the receiver you wish to operate and transmit.



Matching Up Addresses


■ If not wall mounted type indoor unit

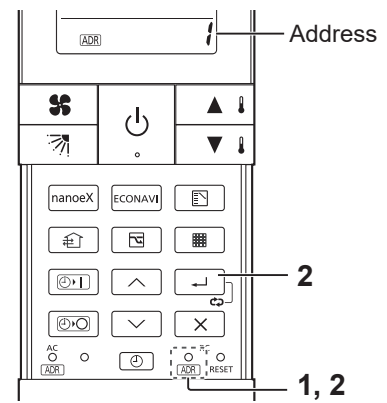
< Setting Remote Controller Addresses >

1. Press  with one end of an unfolded paper clip (or a similar object that can fit) for 4 seconds or longer.

- The current address number starts blinking.

2. Press  to select the address of the receiver you want to control, and press .

- Every time you press , it cycles from “ALL (All the addresses) → 1 → 2 → 3 → 4 → 5 → 6”.
- If it corresponds to the receiver’s address setting, the buzzer sounds.



Note

- Set the address of the receiver as instructed in the operating instructions of your receiver. Do not set by yourself. Contact the dealer where the product was purchased.

■ For wall mounted type indoor unit


< Setting the address of the indoor unit >

1. Press [Emergency Operation]  of the indoor unit for 4 seconds or longer.

- OPERATION lamp, TIMER lamp, and then STANDBY lamp repeatedly light one after the other for 1 second each to indicate the unit is ready for address setting.

< Setting Remote Controller Addresses >

2. Set the address for the remote controller following the procedure under the section “■ If not wall mounted type indoor unit” (see this section noted above).

- Repeat Step 2 under “■ If not wall mounted type indoor unit” if you are setting more units.
- The address setting ready status of the indoor unit ends if data transmission is not received from the remote controller for 3 minutes.
- Press [Emergency Operation]  on the receiver to end the address setting ready status of the indoor unit.


8-10. Emergency Operation

Use [Emergency Operation]  in the following situations when there is an urgent need.








- When the remote controller's batteries have failed.
- When the remote controller is broken.
- When the remote controller is lost.

*See the following figures regarding Emergency button.

1. Press [Emergency Operation] of the receiver.

- The OPERATION lamp is lit.
- Auto operation starts. If Auto operation is not possible, the unit starts cooling if the room temperature at the time is 24 °C or higher; otherwise, the unit starts heating.
- The operation stops if you press [Emergency Operation]  again.

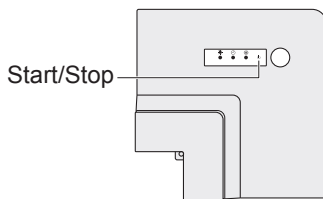
Note

- If non-cooling/heating free type is being used, it will beep twice and the operating lamp will light up on the display; if the timer and standby lamps blink alternately, a conflict between the heating and cooling exists, so the unit cannot operate in the desired mode. (On models that do not have an Auto function, even if Auto is selected, it works in the same way.)
- When the local operation is disabled by a central control device or similar cause, and if the Start/Stop , Fan speed , Flap , Temperature setting  / , Mode select  or Energy saving  button is pressed, the unit will beep 5 times and the change will not be made.

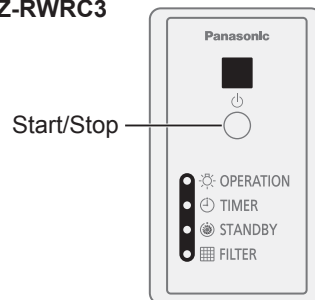
CZ-RWSU3 / CZ-RWSC3

CZ-RWRU3 / CZ-RWRC3

**CZ-RWSU3
CZ-RWRU3**



**CZ-RWSC3
CZ-RWRC3**





8-11. Miscellaneous Settings













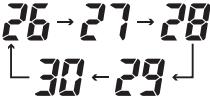
A variety of changes can be made to settings, depending on the indoor unit being used.

Operation mode indicator, time display (24 hour, AM/PM), heating maximum temperature

- These settings are saved in nonvolatile memory in the remote controller, so even when its batteries are changed, the settings do not have to be made again.
- First check the display of the remote controller when the unit is stopped and then make any desired settings.

How to Operate

- While holding down the buttons below, the remote controller's display changes every time  is pressed.
- Whatever is being displayed when you release  is set.


Setting Item	Operation Button	Setting Content	Remote Controller Display
Remote controller operation mode display setting when  is pressed	Press  while pressing 	Heat Pump (with Auto)	
		Heat Pump (without Auto)	
		Dedicated air conditioner	
Clock display setting	Press  while pressing 	24-hour	
		AM/PM	
Max possible temperature setting in the Heat mode	Press  while pressing 	Maximum heating temperature range is 26 °C – 30 °C	





8-12. Button Control

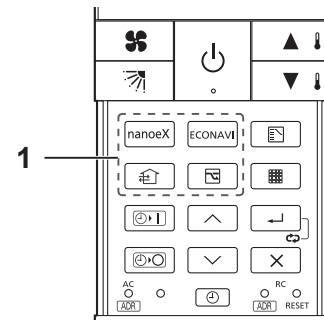
You can enable or disable the following buttons for some indoor units.

nanoe™ X, ECONAVI, Ventilation, Energy saving

1. Press the button for desired setting for 4 seconds or longer.




- You can toggle between enable and disable each time you press the button for 4 seconds or longer.
- “” is displayed when you press a disabled button, and the function cannot be used.

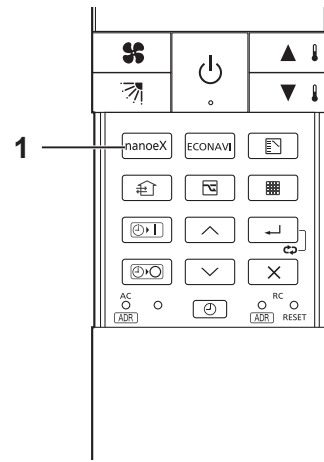
Buttons	Setting content
	Enabling or disabling the button for nanoe™ X.
	Enabling or disabling the button for ECONAVI.
	Enabling or disabling the button for ventilation.
	Enabling or disabling the button for energy saving.



8-13. nanoe™ X Setting

1. Press during operation.




- You can toggle between ON and OFF each time you press .
- “nanoeX” is displayed when this setting is ON.
- When the nanoe™ X setting is ON, “nanoe” (atomised water particle) is released from the indoor unit while in operation (Cool, Dry, Heat, Fan, Auto).
- If the receiver emits 1 short beep followed by 1 long beep after pressing , the indoor unit does not support this function. See the section “8-12. Button Control” on page 8-12 for how to enable or disable the button.
- “” is displayed if the function is not available.

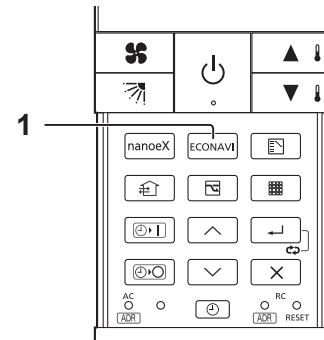


8-14. ECONAVI Setting

(ECONAVI can be set using the separately sold ECONAVI panel or by connecting the holder on the wall.)



1. Press during operation.

- You can toggle between ON and OFF each time you press .
- “ECONAVI” is displayed when this setting is ON. *
- The ECONAVI sensor detects human activity and conserves energy based on the activity level.
- Even when target temperature is changed through the ECONAVI function, the set temperature shown in the remote controller does not change.
- When operating more than 1 indoor unit, the energy-saving effect may be reduced depending on the room condition.
- If the receiver emits 1 short beep followed by 1 long beep after pressing , the indoor unit does not support this function. See the section “8-12. Button Control” on page 8-12 for how to enable or disable the button.
- “” is displayed if the function is not available.
- * “ECONAVI” is not displayed in Fan mode.






8-15. Ventilation Setting

(When connected to an aftermarket fan)

 button is disabled as the factory setting. Enable the  button if you have connected the ventilation fan.





(See the section “8-12. Button Control” on page 8-12.)

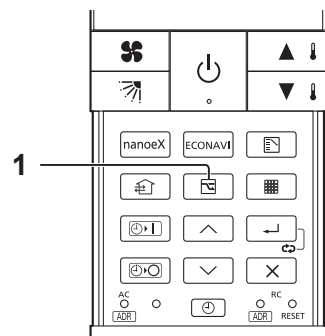
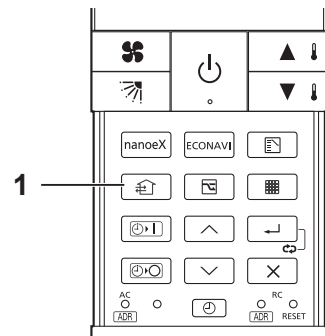
1. Press .

- You can toggle between ON and OFF each time you press .
- “” appears on the display of the remote controller when the fan is operating.
- When the air conditioner is started or stopped, the fan starts or stops at the same time.
- “” is displayed if the function is not available.

8-16. Energy Saving Setting

1. Press during operation.



- You can toggle between ON and OFF each time you press .
- “” is displayed when this setting is ON.
- The energy saving operation restricts the maximum current value, resulting in decreased cooling/heating performance. (If the current of outdoor units does not reach the peak due to low load operation, the current value is not restricted.)
- If the receiver emits 1 short beep followed by 1 long beep after pressing , the indoor unit does not support this function. See the section “8-12. Button Control” on page 8-12 for how to enable or disable the button.
- “” is displayed if the function is not available.




8-17. Temperature Automatic Return






You can restore the changed temperature to the originally set temperature automatically after a specified time elapses.



• Set the time and temperature for each operation mode.

1. Press  and  at the same time for 4 seconds or longer.




• “” starts blinking and the setting screen is displayed.





2. Press  to select the operation mode, then press .

- Every time you press  to switch between “Dry  / Cool  → Heat  → Auto 

3. Press  /  to set the time to return to the set temperature.



• Setting range: 10 to 240 min (by the 10 min)

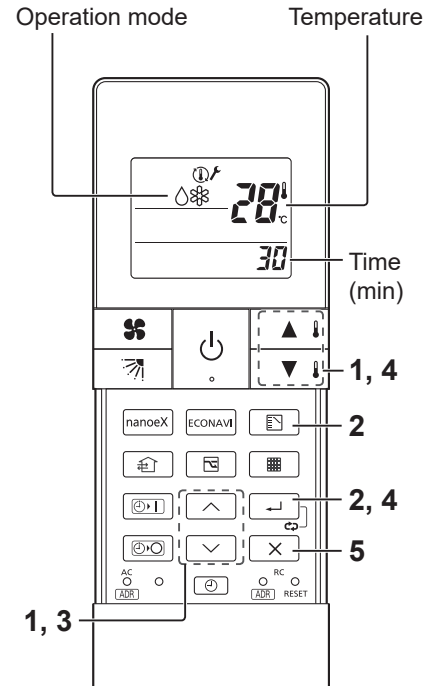
4. Press  /  to set the temperature, then press .

	MAX (°C)	MIN (°C)
Auto 	27	17
Heat 	30	16
Dry  / Cool 	30	18

• The temperature range that can be set varies depending on the model.

5. Press .

• You can return to Step 2 to continue setting if you press  instead of .




Changing the setting

Perform Step 1 to 5 noted above as you did when setting.

Cancelling the setting

1. Press  and  at the same time for 4 seconds or longer.

2. Press  to select the operation mode, then press  for 4 seconds or longer.


- The receiver emits 1 short beep.
- Press  for 10 seconds or longer to cancel settings for all operation modes.

Note

• Press  to stop operation in the middle.

8-18. Troubleshooting

Before requesting service, please check the followings.

Problem	Cause	Solution
The unit doesn't work even when  is pressed on the remote controller.	The power to the indoor unit is not ON.	Make sure the power to the indoor unit is ON.
	Are the remote controller's batteries dead?	Change the batteries.
	Is there a mismatch between the display lamp and cooling/heating or is it set to something other than Auto? (The operating lamp stays lit, while the timer lamp and the standby lamp blink alternately.)	Change the operating mode.
	Do the addresses match one another?	Check the addresses of the receiver and the remote controller. (See page 8-10)
The air conditioner starts and stops on its own.	Has the timer been set to repeat?	Check the timer settings. (See page 8-7)
Although the unit is for air conditioning only, either Auto or Heat is indicated in the display.		Make settings to the remote controller's operation mode display. (See the section "8-11. Miscellaneous Settings" on page 8-12)
After the batteries are put in the remote controller, even when it is operated, the display does not change.		Press the RC reset button on the remote controller. (See page 8-5)
The timer cannot be set.		Make the settings when the remote controller is in Operation Display. (See page 8-7)

If the problem persists even after you check the foregoing items, stop the unit, disconnect the power to the indoor unit and contact the dealer where the product was purchased with the model number and problem you are having.

As it is dangerous, under no circumstances should you undertake repairs yourself.

Further, when the receiver's lamps are blinking; please contact your retailer with that information.

Specifications

CZ-RWSU3/CZ-RWSC3/CZ-RWSK2

Wireless Remote Controller	Dimensions	182 mm (H) X 61 mm (W) X 18.5 mm (D)
	Power source	Two LR03 size batteries
	Clock Accuracy	±30 seconds per month (at 25 °C)

CZ-RWS3

Wireless Remote Controller	Dimensions	165 mm (H) X 59 mm (W) X 22 mm (D)
	Power source	Two LR03 size batteries
	Clock Accuracy	±90 seconds per month (at 25 °C)

CZ-RWSU3 / CZ-RWSC3

CZ-RWRU3 / CZ-RWRC3

Receiver	Dimensions	CZ-RWSU3, CZ-RWRU3	29.7 mm (H) X 211.8 mm (W) X 211.8 mm (D)
		CZ-RWSC3, CZ-RWRC3	120 mm (H) X 70 mm (W) X 20 mm (D)
	Power source	16 V DC (Supplied from the terminal strip of the indoor unit's remote controller)	





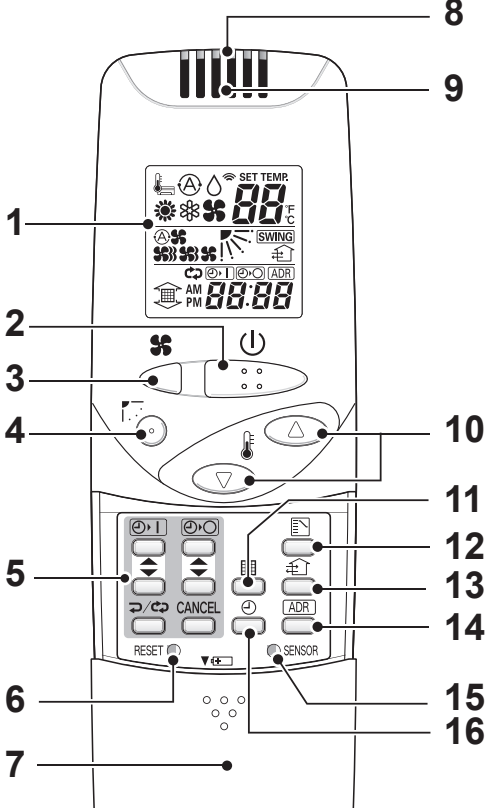










■ Optional Controller (Remote Controller)


Wireless Remote Controller CZ-RWSU3 / CZ-RWSC3 / CZ-RWSK2

One remote controller can control a group of up to eight indoor units.

8-19. Names and Functions

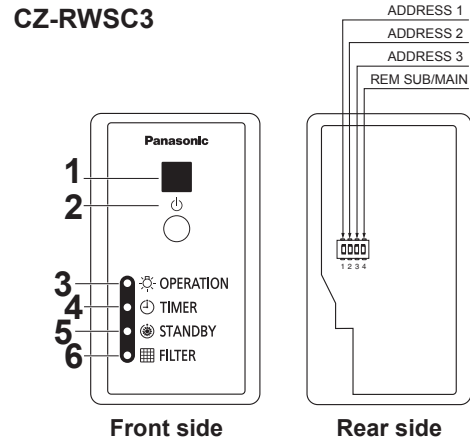
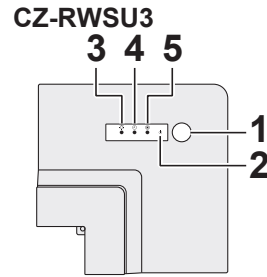
REMOTE CONTROLLER

1. Operation Display	Displays the operation status. (The figure shows all the statuses.) • The auto-flap display may be different, depending on the installed unit.	15. Sensor button	Use this button to activate the temperature sensor on the remote controller instead of the one on the indoor unit. The temperature sensor on the indoor unit is selected before shipment. At this time  is shown on the display.
2. Start/Stop button 	Pressing this button once starts and pressing again stops the operation.	16. Clock button 	Use this button to set the clock.
3. Fan speed button 			
4. Swing/Wind Direction button 			
5. Timer setting button  	Use for operating with a timer.		
6. Reset button	Use this button after changing the batteries.		
7. Cover	Press at the top center and then slide down.		
8. Transmitter			
9. Remote controller sensor	Detects the temperature at the remote controller when detection has been switched to the remote controller by the sensor button.		
10. Temperature setting buttons	 raises the temperature setting 1 °C at a time.  lowers the temperature setting 1 °C at a time.		
11. Filter button 	CZ-RWSC3 Press to turn off the filter lamp on the receiver.		
12. Mode Select button 	Press to switch the operation mode.		
13. Ventilation button 	Use this button when connected to an aftermarket fan. Pressing this button starts and stops the fan. When the air conditioner is started or stopped, the fan starts or stops at the same time. ( appears on the display of the remote controller when the fan is operating.)		
14. Address button 			

From this page on the names of remote controller's buttons will be indicated with the above illustrations.
 E.g.: Start/Stop button → 

RECEIVER

1. Receiver	Receives the signal sent from the remote controller.
2. Emergency operation button	Display lamps When an error occurs, one of the lamps flashes. When a display lamp is blinking, refer to " Before Requesting Service ".
3. Operating lamp	This lamp is lit when the unit is operating.
4. Timer lamp	This lamp is lit when the timer is set.
5. Standby lamp	<ul style="list-style-type: none"> • When the heater is working, the lamp lights at the following times. When the thermostat has operated during defrosting at the time of the startup. • The lamp flashes when an error occurs.
6. Filter lamp	This lamp is for notifying you when the filter needs to be cleaned.



NOTE

- If a heat pump model is being used, it will beep twice and the operating lamp will light up on the display; if the timer and standby lamps blink alternately, a conflict between the heating and cooling exists, so the unit cannot operate in the desired mode. (On models that do not have an Auto function, even if Auto is selected, it works in the same way.)
- When the local operation is disabled by such as the centralized control, and if the Start, Stop, Mode or Temperature setting buttons are pressed, the unit will beep five times and the change will not be made.

8-20. Installing Batteries

1. Remove the cover.

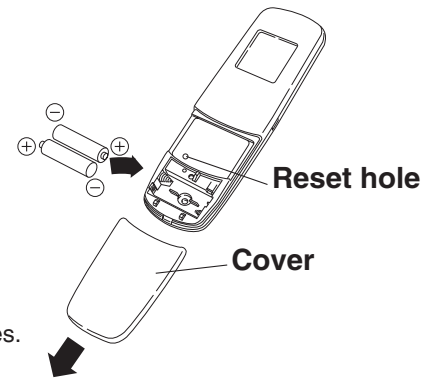
2. Insert two LR03 size batteries.

Put the batteries in with the polarity [+/-] as shown in the figure.

3. Gently insert one end of an unfolded paper clip (or a similar object that can fit) into the Reset hole and press the Reset button inside the hole, then put the cover back on.

NOTE

- Change the batteries when the display of the remote controller gets weak or if it will not work unless close to the receiver.
(Alkaline batteries generally last about one year.)
- When changing batteries, always use two fresh batteries of the same make.
- If the remote controller will not be used for a long period of time, remove the batteries.
- Please dispose of batteries appropriately.
- After changing the batteries, follow the procedures on the next page to reset the current time.



How to remove batteries

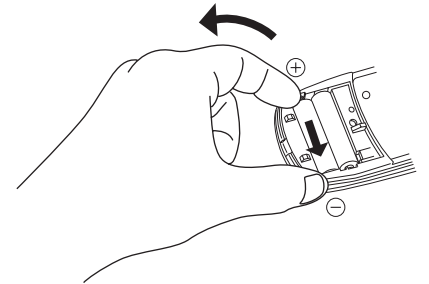
1. Remove the cover.

2. Press the battery toward the negative end and lift it out by its positive end.
(As shown at right)

3. Remove the other battery in the same way.

NOTE

- Dispose of the used batteries at the designated location in compliance with the applicable local ordinances.



WARNING

- Do not swallow the battery.
- After removing the battery from remote controller, keep it away from the reach of children.
The battery can cause death by suffocation if swallowed.
- When inserting the battery, make sure the polarities (+ and -) are correct.

8-21. Setting the Current Time

After changing the batteries and pressing reset, be sure to reset the current time.

(When reset is pressed, the current time reverts to [0:00])

1. Press \ominus for two seconds or more.

Once the clock displays starts blinking, the clock can be set.

2. Set the hour with \blacktriangle / \blacktriangledown of the \odot .

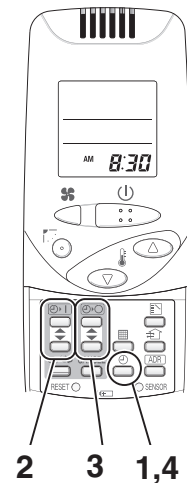
If you press and hold the button, the time changes quickly.

3. Set the minutes with \blacktriangle / \blacktriangledown of the \odot .

If you press and hold the button, the time changes quickly.

4. Pressing \ominus completes the time setting.

- While you are setting the current time, the time display flashes but the colon does not.
- If the buttons are not pressed for three minutes while setting the current time, it is set to the displayed time.



NOTE













When reset is pressed, the timer settings are deleted.

8-22. Operation





Auto , **Heat** , **Dry** , **Cool** , **Fan** 

Models that only provide the cooling function cannot operate in the auto or heating modes.

Power: Turn on the power of the indoor unit at least 14 hours before operation.

1. Press .
2. Press  and select from among Auto , Heat , Dry , Cool  and Fan .
3. Press  and select the desired speed.
If set to Auto  , the fan speed switches automatically.
(Auto does not work when in the Fan mode.)
4. Press one of the   buttons and set the desired temperature.

Temperature settings cannot be made when in the Fan mode.

	MAX	MIN
Auto 	27	17
Heat 	30	16
Dry  / Cool 	30	18

Stop: Press .

When the unit is stopped with the remote controller, the fan on the outdoor unit may continue to run for a while, even though the compressor of the outdoor unit stops.

If the unit is not heating very effectively with a Low fan speed , switch the fan speed to High  or Medium .

Depending on the indoor unit being used, it may indicate a function that it does not have. (The fan speed is set.)


If you cannot turn the air conditioner off in the normal way.

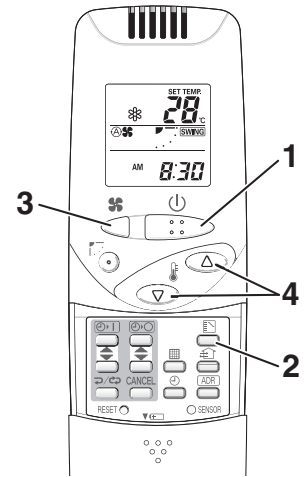
Disconnect the power to the indoor unit and contact the dealer where the product was purchased.

<Auto Operation>

Only when identical refrigerant system inside all the indoor units or cooling/heating free-type are under control as one group. It heats or cools automatically via the differences between the set temperature and the room temperature.

<Dry Operation>

- Depending on the indoor unit used, the remote controller may have a [Dry]  indicator on its display even though the unit does not have the Dry function. (Same as cooler operation)
- When the room temperature approaches the temperature setting, the unit continues to start up or stop automatically.
- When the drying mode stops operating, the indoor unit's fan blows a gentle breeze in order to keep the moisture from returning to the room at a minimum.
- Depending on the indoor unit used, and/or the temperature in the room, the fan speed may not be adjustable.
- Depending on the unit used, when the outside air temperature is 15 °C or less, the dry function will not operate.



8-23. Timer Operation

- When setting the timer, make sure the current time on the remote controller is accurate.
- The timer's clock can only be set when the display of the remote controller is ON.
- After setting the timer, put the remote controller in a place where its signal will reach the receiver of the indoor unit. (When the time set for the timer is reached, a signal is sent from the remote controller to Start/Stop the unit.)

Using the Timer

1. Press either ▲ / ▼ of the or , and while the time is being displayed, if you press ▲ / ▼ again, a scheduled time can be set.

The time last set on the timer is displayed.

“--:--” indicates time to change the batteries.

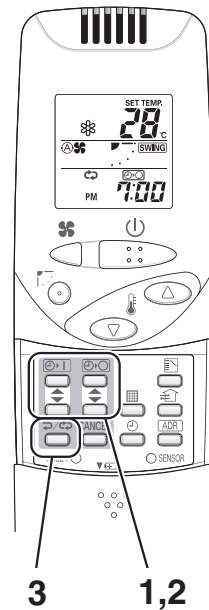
2. Press either ▲ / ▼ of the or and set the timer to the desired time.

Every time you press ▲ / ▼, the time changes in 10 minute increments.

If you press and hold the button, the time changes quickly.

3. After setting the timer, if you press , the time you set changes to a steady display, indicating settings are complete.

After the timer setting is displayed for three seconds, the display reverts to the current time.



Combining ON and OFF Timers

- Setting the ON and OFF timers, respectively.

Checking the timer setting

- If you press either ▲ / ▼ for the or the , the scheduled time is displayed for four seconds.
- When no timer setting has been made, it displays --:--. (Initial Setting)

Changing a timer setting

- Press ▲ / ▼ for the or the , and then when the timer setting is displayed, press ▲ / ▼ for the timer again.

Canceling a timer setting

- If you press [CANCEL], the timer setting is canceled.
- If you wish to cancel the setting for either the or the timer, press ▲ / ▼, and long-press [CANCEL] while scheduled time is displayed.

Using the same timer setting every day

- If you press for 2 or more seconds, “” is displayed and the **ON timer** or the **OFF timer** will operate repeatedly every day.
- If you press again for two seconds or more, “” goes off and the timer operates only one time.


8-24. Adjusting the Wind Direction

- Never try to manually move the flap (up-down wind direction plate) that is operated by the remote controller.
- When the unit stops, the flap (up-down wind direction plate) automatically faces downwards.
- When the unit is in heating standby, the flap (up-down wind direction plate) faces upward.



Also, bear in mind that the flap starts swinging after the heating standby mode is released, but the display on the remote controller indicates Auto Flap during standby heating as well.

CZ-RWSU3



Setting the Wind Direction

While the unit is operating, every time you press , the direction the flap faces changes.

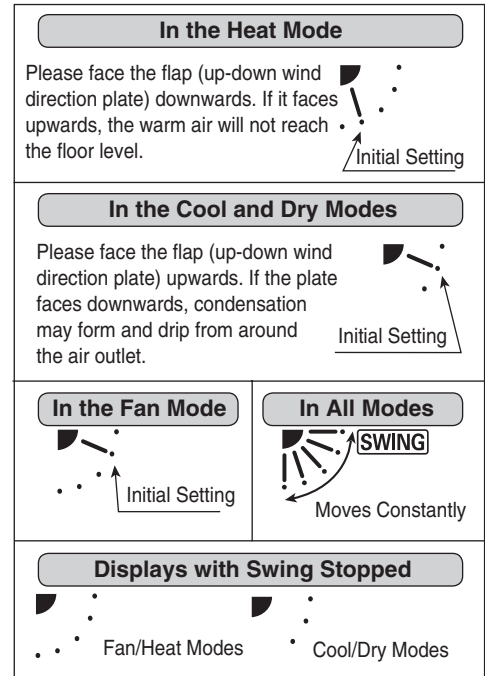
Setting Flap to Swing

If you press  to set the flap (up-down wind direction plate) in its most downward facing position, and then press  again, **SWING** is displayed and the flap swings automatically up and down.

Stopping Flap Swing

If you press  again while the flap is swinging, you can stop the flap from swinging and set it in place as desired. Thereafter, if you press , you can set the wind direction starting from the most upward position.

- When the unit is in the Cool or Dry modes, the flap cannot stop facing downwards. If you try to stop the flap from swinging while it is facing downwards, it will continue moving until it is in the third position from the top.



CZ-RWSC3

The available functions differ depending on the indoor unit being used.

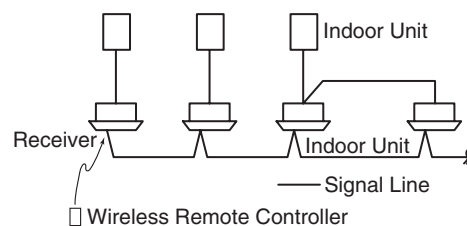
The wind direction cannot be set via remote controller for any models other than those noted below.

For more information, please refer to the users' manual that came with your indoor unit.

8-25. Operating Multiple In/Outdoor Units Simultaneously (Group Control)

Group control works well for providing air conditioning to one, large room with more than one air conditioning units.


- One remote controller can operate up to eight indoor units.
- All the indoor units have identical settings.
- Set temperature sensing to the indoor unit (Main Sensor).
(See page 8-16.)



8-26. Using the Remote Controller

- Point the transmitter of the remote controller at the receiver. When the signal is received correctly it will beep once. (It beeps twice only when the unit starts operating.)
- The signal can be received at a distance of about 6 meters. This distance should be used only as a guide. It depends on battery strength.
- Make sure nothing is between the remote controller and the receiver that could block the signal.
- Do not leave the remote controller in direct sunlight, where the wind from the air conditioner can blow directly on it, or near any other heat source.
- Take care not to drop, throw or wash the remote controller with water.
- The signal from the remote controller may not be received in rooms with rapid start fluorescent lighting, inverter lights, plasma displays, LCD televisions (monitor), etc. For more information, please contact the dealer where the product was purchased.

Wall Mount Use

- Press  from the location you wish to mount the remote controller and make sure the signal is received properly.
- Pull the remote controller forward to remove it.

8-27. For Best Results

Don't get the remote controller too far away from the receiver.

This may cause a malfunction. Be sure to keep the remote controller in the same room as the receiver.

Point the remote controller at the receiver.

When the signal is received properly, it will beep one time.

Avoid locating the remote controller where it is covered, such as behind a curtain.

Keep it out in the open.


8-28. Addresses

In both multi and single unit installations, when more than one indoor units are installed in the same room with a compatible wireless remote controller, addresses can be set up to avoid crosstalk. By setting the address switches on the receivers and matching them with the number of addresses on the remote controller, up to six indoor units can be controlled separately with the remote controller. (When using units in a flexible combination or operating multiple units simultaneously, they cannot be controlled individually as they are operated at the same time.) There are separate address settings, receiver addresses for the receivers and transmitter addresses for the remote controller.

For more information, please contact the distributor where the product was purchased.

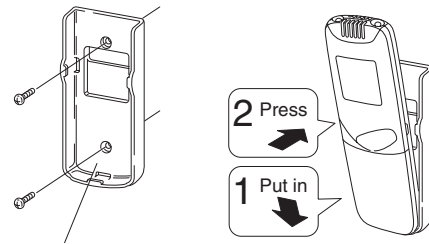
- These settings are saved in nonvolatile memory in the remote controller, so even when its batteries are changed, the settings do not have to be made again.

Checking Addresses

When you press  on the remote controller, its current address appears on the display. If this address corresponds to the address of a receiver, the buzzer sounds. (If it is on ALL, the buzzer will always sound.)

If it is on ALL, it can be operated regardless of receiver addresses. Point the remote controller at the receiver you wish to operate and transmit.

Fasten the remote controller holder with screws. Fitting the remote controller in the holder.



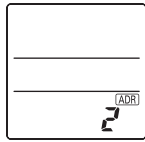
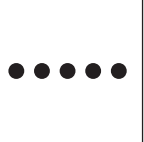
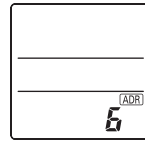
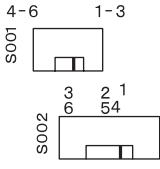
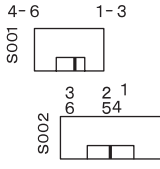
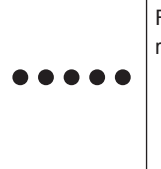
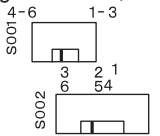
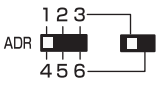
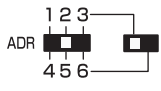

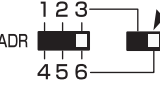


Remote controller holder


Matching up Addresses

Setting Remote Controller Addresses

1. If you press **[ADR]** and **↻/↺** at the same time, "SET" will blink.
2. While holding **[ADR]** down, every time you press **↻/↺**, it cycles from ALL → 1 → 2 → 3... 6 → ALL.
Set it to the receiver address switch of the indoor unit you wish to operate.
3. When you release **[ADR]**, the address that was displayed is set.
When you do this, if it corresponds to the receiver's address setting, the buzzer sounds.

Address Display on the Remote Controller					
CZ-RWSU3					
Position of receiver's (inside indoor unit) address switch	The position of the receiver's address switch does not matter.				For 1, 2 and 3, set the switch on the right and for 4, 5 and 6, to the left. 
CZ-RWSC3					
Position of the Receiver's Address Switch	The position of the receiver's address switch does not matter.				For 1, 2 and 3, set the switch on the left and for 4, 5 and 6, to the right. 

NOTE

- Please do not hold the [Emergency Operation]  button of the indoor unit down while the indoor unit's display lamps are blinking one after another.
- Make sure to operate while the indoor unit is stopped.
- The address of indoor unit is set to "ALL" at the time of the shipment.

8-29. Emergency Operation

Use [Emergency Operation]  in the following situations when there is an urgent need.

- When the remote controller's batteries have failed.
- When the remote controller is broken.
- When the remote controller is lost.

CZ-RWSU3 / CZ-RWSC3

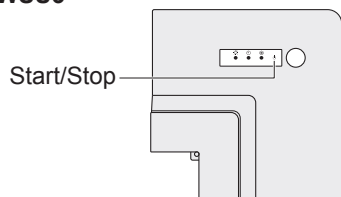
Start : press [Emergency Operation]  of the receiver.

If the indoor temperature is 24 °C or greater when the unit starts running, it will act as a cooler.

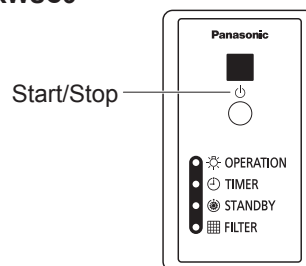
If the indoor temperature is less than 24 °C when the unit starts running, it will act as a heater.

Stop : press [Emergency Operation]  of the receiver again.

CZ-RWSU3



CZ-RWSC3





8-30. Miscellaneous Settings













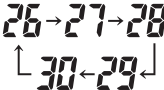
A variety of changes can be made to settings, depending on the indoor unit being used.

Operation mode indicator, time display (24 hour, AM/PM), Heat Max Temp

- (These settings are saved in nonvolatile memory in the remote controller, so even when its batteries are changed, the settings do not have to be made again.)
- First check the display of the remote controller when the unit is stopped and then make any desired settings.

How to Operate

- While holding down the buttons below, every time  is pressed the remote controller's display changes.
- Whatever is being displayed when you release  is set.

Setting Item	Operation Button	Setting Content	Remote Controller Display
Remote controller operation mode display setting when  is pressed	Press  while pressing 	Heat Pump (with Auto)	
		Heat Pump (without Auto)	
		Dedicated air conditioner	
Clock display setting	Press  while pressing 	24 Hour	
		AM/PM	
Max possible temperature setting in the Heat mode	Press  while pressing 	Maximum heating temperature range is 26 °C – 30 °C	

8-31. Before Requesting Service

Before requesting service, please check the followings.

Problem	Cause	Solution
The unit doesn't work even when \odot is pressed on the remote controller.	The power to the indoor unit is not ON.	Make sure the power to the indoor unit is ON.
	Are the remote controller's batteries dead?	Change the batteries.
	Is there a mismatch between the display lamp and cooling/heating or is it set to something other than Auto? (The operating lamp stays lit, while the timer lamp and the standby lamp blink alternately.)	Change the operating mode.
	Do the addresses match one another?	Check the addresses of the receiver and the remote controller. (See Page 8-22)
The air conditioner starts and stops on its own.	Has the timer been set to repeat?	Check the timer settings. (See Page 8-20)
"EP" is displayed on the remote controller when the unit is stopped.	An error has occurred in the non-volatile memory.	Please contact your sales outlet.
Although the unit is for air conditioning only, either Auto or Heat is indicated in the display.		Make settings to the remote controller's operation mode display. (See Page 8-25)
After putting the batteries in the remote controller, even when it is operated, the display does not change.		Press the Reset button on the remote controller. (See Page 8-18)
The timer cannot be set.		Make the settings when the remote controller is in Operation Display. (See Page 8-20)

If the problem persists even after you check the foregoing items, stop the unit, disconnect the power to the indoor unit and contact the dealer where the product was purchased with the model number and problem you are having.

As it is dangerous, under no circumstances should you undertake repairs yourself.

Further, when the receiver's lamps are blinking; please contact your retailer with that information.

Specifications

CZ-RWSU3 / CZ-RWSC3 / CZ-RWSK2

Wireless Remote Controller	Dimensions	182 mm (H) X 61 mm (W) X 18.5 mm (D)
	Power source	Two LR03 size batteries
	Clock Accuracy	±30 seconds per month (at 25 °C)

CZ-RWSU3 / CZ-RWSC3

Receiver	Dimensions	CZ-RWSU3	29.7 mm (H) X 211.8 mm (W) X 211.8 mm (D)
		CZ-RWSC3	120 mm (H) X 70 mm (W) X 20 mm (D)
	Power source	16 V DC (Supplied from the terminal strip of the indoor unit's remote controller)	

■ Wiring for the Receiver

8-32. Common to All Models

1. Installation Location for the Receiver

- The wireless remote controllers use a very weak infrared light for its signal, which can result in the signal not being received because of the following influences, so take care in where the unit is installed.
 - Inverter or rapid-start type fluorescent lights. (Models without glow lamps)
 - Plasma display or LCD televisions.
 - Direct sunlight or other sources of bright light.
- Do not bundle together with the power source wiring or store in the same metal tube. Operation error may occur.
- Be careful not to connect cables to other terminals of indoor units (e.g. power source wiring terminal). Malfunction may occur.
- Avoid the following locations for installation.
 - Location where condensation occurs
 - Location where voltage fluctuation frequently occurs
 - Location where there is a machine producing electromagnetic radiation

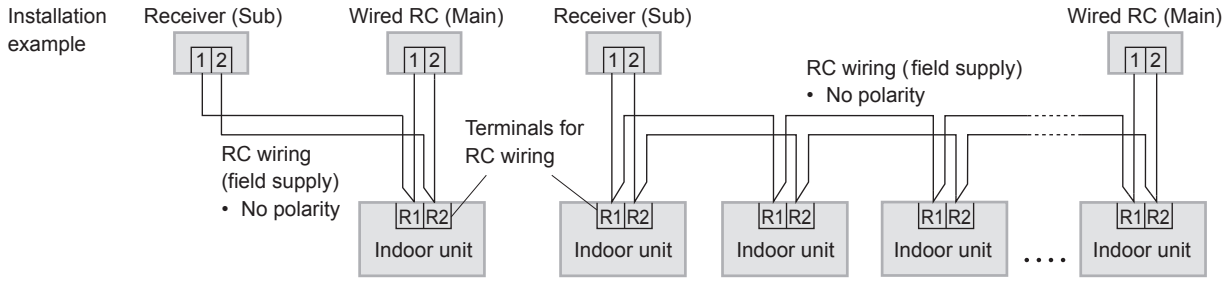
2. Installation location for the Wireless Remote Controller

- If a remote controller is to be operated from a remote control holder that is hung on a wall, turn on the lights in the room as well as any electrical appliances and then check to make sure the air conditioner works with the remote controller in the location where it will be installed. If it works, continue with installation.
- If the main sensor is to be switched from the indoor unit to a remote controller, pay attention to the following when installing.
 - Locate where no warm or cold air will affect it.
 - Locate in a place free from direct sunlight.
 - Locate where it will not be affected by any other heat/cold source.

Installation when setting Main/Sub for the remote controller and the receiver

■ Using 1 indoor unit

■ Using more than 1 indoor unit

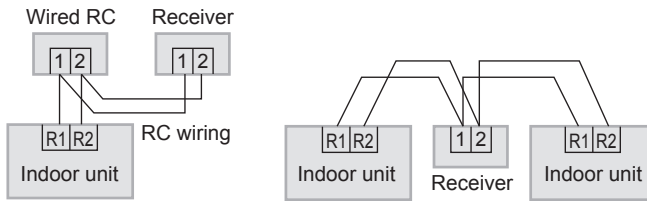


After installation, according to the “Settings” section, set one to [Main] and the other to [Sub].
Setting the wired remote controller to [Main] is recommended.

Attention

- Multiple wireless/infrared remote controllers cannot be used simultaneously for a single indoor unit.
- Be careful not to connect cables to other terminals of indoor units (e.g. power source wiring terminal). Malfunction may occur.
- Do not bundle together with the power source wiring or store in the same metal tube. Operation error may occur.
- If noise is induced to the unit power supply, attach a noise filter.

* Wiring shown below is prohibited.



NOTE

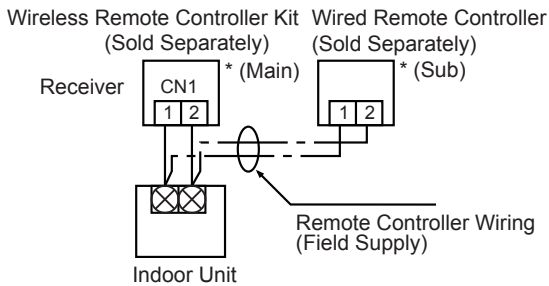
The remote controller and the receiver can be connected to any indoor unit for operation.

When 1 indoor unit is operated by 2 remote controllers:

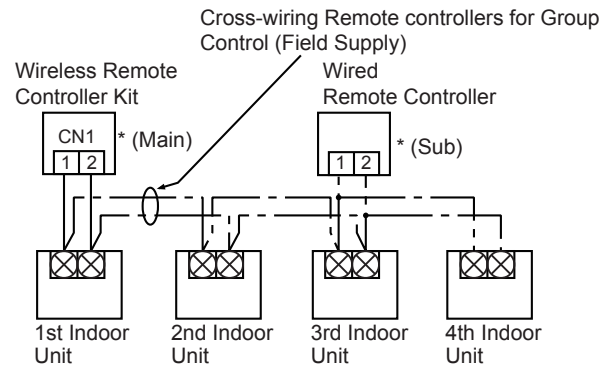
* Either of the remote controllers can be set to main/sub.

If a group of units are to be controlled by 2 remote controllers:

* Main/sub remote controllers will work regardless of which indoor unit they are installed.









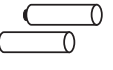

- Use wiring of 0.5 mm² to 2 mm² for field supply.
- Use a total wire length of no more than 400 m.



- Use wiring of 0.5 mm² to 2 mm² for field supply.
- Make the total wire length when cross-wiring a group no more than 200 m.

8-33. CZ-RWSU3, CZ-RWRU3

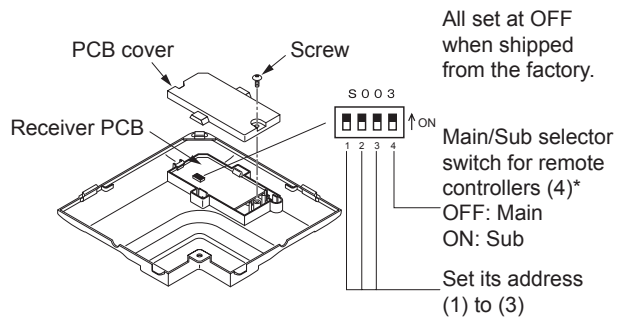
1. Accessories

Supplied accessories								
Clamper (1)	Operating Instructions (1)	Quick Reference (1)	Installation Instructions (1)	Wireless Remote Controller (1)	Remote Control Holder (1)	LR03 Size Battery (2)	Wood Screw M4 × 16 (2)	
								
CZ-RWSU3	<input type="radio"/>	<input type="radio"/>	<input type="radio"/>	—	<input type="radio"/>	<input type="radio"/>	<input type="radio"/>	<input type="radio"/>
CZ-RWRU3	<input type="radio"/>	<input type="radio"/>	—	<input type="radio"/>	—	—	—	—

2. Settings







Setting for Receiver

- Check the settings of the [S003] DIP switch on the receiver's PCB.
- * Remove the cover from the receiver when performing the PCB settings.
- * When using the infrared remote controller and the wired remote controller in combination, set the wired remote controller to [Main].



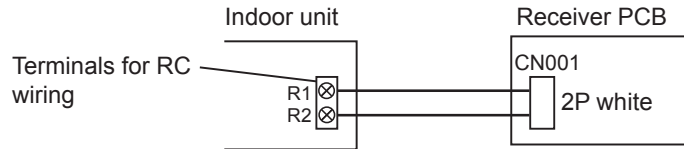
Setting Address Switches

- When more than 1 receiver is installed in the same room, setting addresses prevents interference.
- For how to change addresses of wireless remote controllers, see the operating instructions of wireless / infrared remote controllers.
- To change the receiver's address, remove the cover from the receiver's PCB and set No.1 to No.3 of the [003] DIP switch on PCB.

Remote Controller Address Display	Address	Address	Address	Address	Address	Address	Address	ON/OFF States
	ALL	1	2	3	4	5	6	
Position of the receiver's address switch	Receipt is possible at all of the address positions							

3. Wiring the Receiver

• Wiring Diagram



How to Connect the Wires

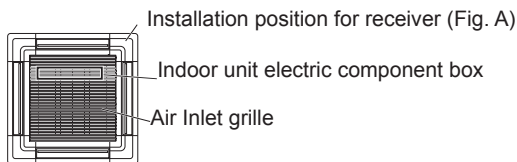
- Connect the wires from the receiver to the terminals for RC wiring on the indoor unit. (No polarity)

4. Installing the Receiver

- The receiver can be installed only on the corner shown in Fig. A. Consider the direction where the panel is attached to the indoor unit.

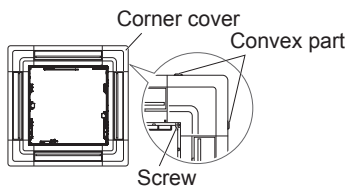
1 Remove the air inlet grille

Indoor unit electric component box

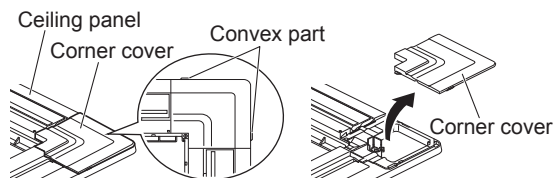


2 Remove the corner cover

- ① Remove the screw fixing the corner cover.

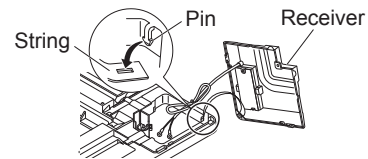


- ② Place a hand on both the right and left convex parts of the corner cover to remove it.



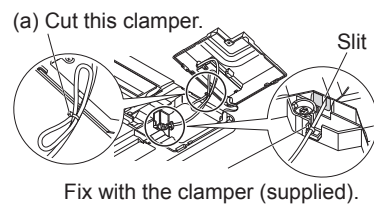
3 Wire the receiver

- ① Hang the string of the receiver on the pin of the ceiling panel.



- ② Pass the wiring from the wireless receiver section into the slit. (See "Wiring for the receiver")
- ③ Fix the wiring with the clammer (supplied) while leaving enough length of wiring to remove the receiver.

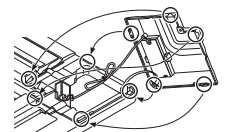
- When attaching the filter chamber, cut the clammer (a), and attach the receiver.



4 Fix the receiver

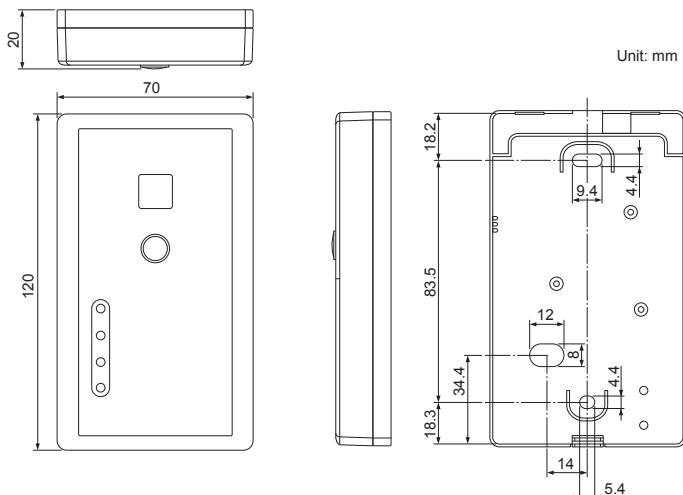
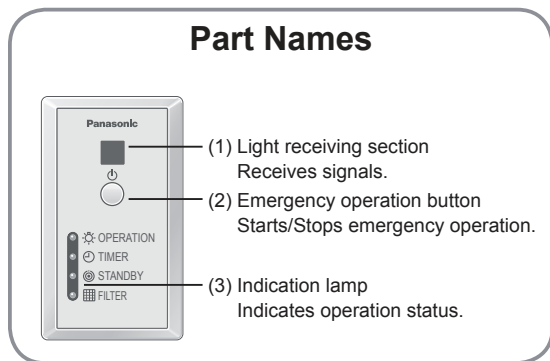
- ① Fit the receiver to the ceiling panel so the 5 claws are properly set, and fix it with the removed screw.

- Make sure the wire is not caught.
- Refer to the installation instructions supplied with the panel.



8-34. CZ-RWSC3, CZ-RWRC3 Installation Instructions

Dimensions



Read before installation

This receiver must be installed by the sales dealer or installer. These instructions are all you need for most installation sites and maintenance conditions. If you require help for a special problem, contact our sales/service outlet or your certified dealer for additional instructions.

Safety Precautions

We assume no responsibility for accidents or damages resulting from methods other than those described in the installation instructions or methods without using specified parts.

Malfunctions that occurred due to the unauthorised installation methods are not covered by the product warranty.

- Read the installation instructions supplied with indoor units as well.
- After the installation is complete, perform test operation to confirm that no abnormality is present.
- When relocating or repairing this receiver, provide the Installation Instructions to the servicing personnel.
- Do not clean inside the receiver by users. Engage authorised dealer or specialist for cleaning.

⚠ WARNING

This symbol refers to a hazard or unsafe practice which can result in severe personal injury or death.

⚠ CAUTION

This symbol refers to a hazard or unsafe practice which can result in personal injury or product or property damage.

⚠ WARNING

- Turn off the circuit breaker of the units before installation.
- This receiver shall be installed in accordance with National Wiring Regulations.
- Connect and fix the specified cables for wiring securely.
- Do not allow the connection to be exposed to the external force of the cables.
- Select an installation location which is rigid and strong enough to support or hold the receiver, and select a location for easy maintenance.
- This receiver must not be modified or disassembled under any circumstances. Modified or disassembled receiver may cause fire, electric shock or injury.

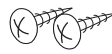
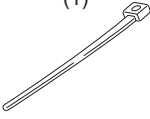

⚠ CAUTION

- Do not use the receiver at the following locations.
 - Location where flammable gases, etc. may leak
 - Location where corrosive gases, etc. may leak
 - Location with lots of water or oil droplets (including machine oil)
 - Location where droplets of organic solvents spread
 - Location where acidic or alkaline solutions or special sprays are frequently used
- Do not wash with water.
- Do not operate with wet hands.

NOTICE

The English text is the original instructions. Other languages are translation of the original instructions.

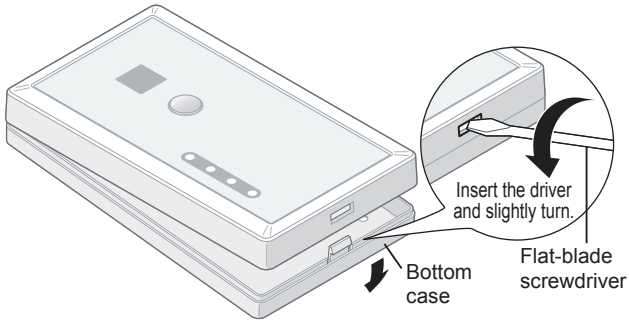
1. Accessories

Supplied accessories		
Wood screw M4 × 15.5 (2) 	Clamper (1) 	Installation Instructions (1) 

CZ-RWSC3	○	○	—
CZ-RWRC3	○	○	○

2. Installing the Receiver

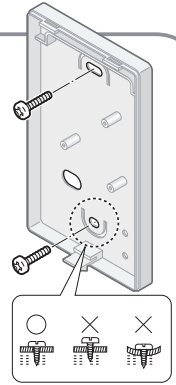
1 Remove the bottom case.



Attention

Mounting the bottom case

- Tighten the screws securely until the screw heads touch the bottom case. (Otherwise, loose screw heads may hit the PCB and cause malfunction when mounting the top case.)
- Do not over-tighten the screws. (The bottom case may be deformed, resulting in fall of the unit.)



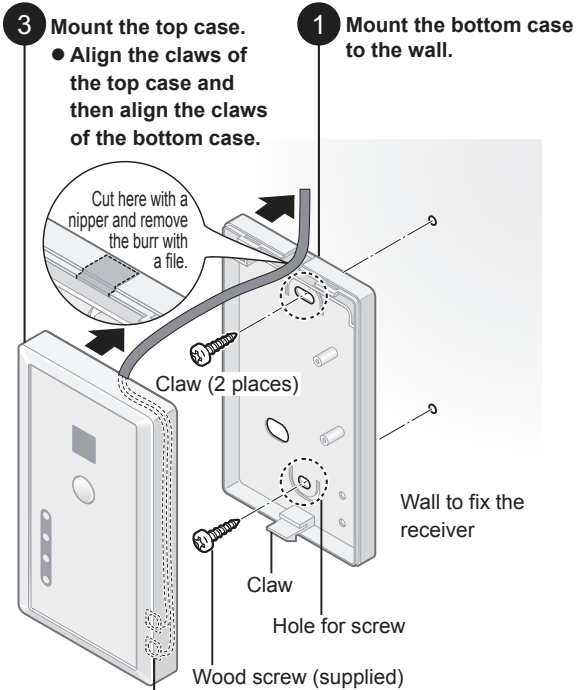
Connecting the remote controller wiring

- Arrange the wires as shown in the illustration for 2 in step 2, avoiding unnecessary wires being stored in the case. (Caught wires may destroy the PCB.)
- Avoid wires touching parts on the PCB. (Caught wires may destroy the PCB.)

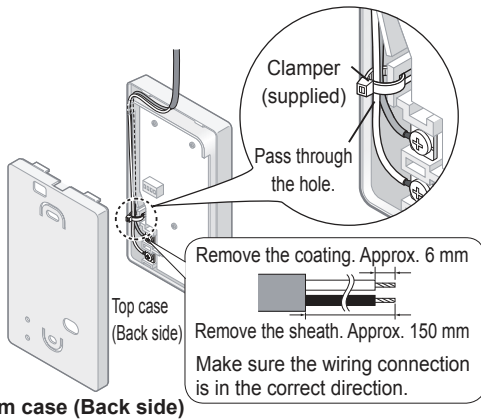
2 Mount to the wall.

Exposed type

Preparation: Make 2 holes for screws using a driver.

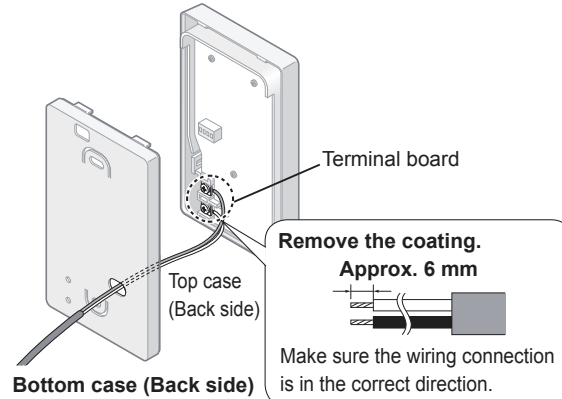
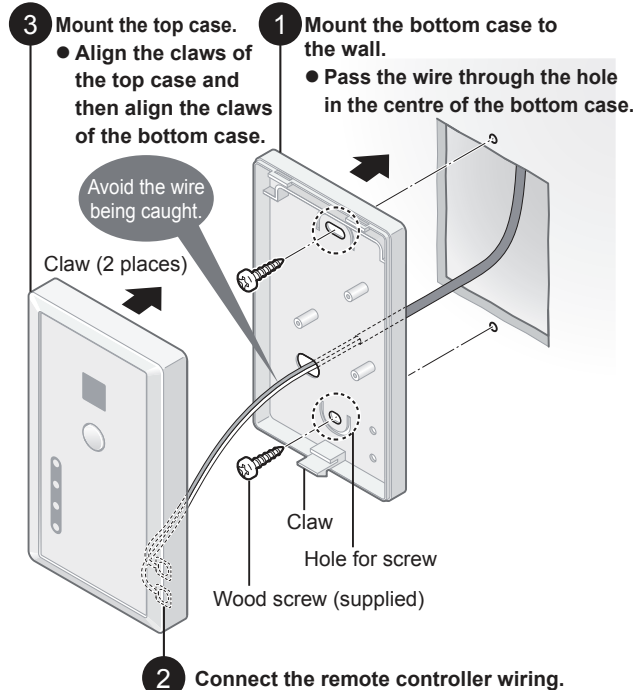


- 2 Connect the remote controller wiring.**
- Arrange the wires along the groove of the case.



Embedded type

Preparation: Make 2 holes for screws using a driver.



3. Wiring the Receiver

Wiring for the receiver

■ **Wiring diagram**

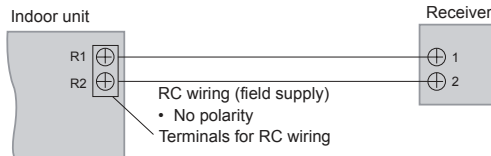
■ **Type of wiring**

Use cables of 0.5 to 1.25 mm².

■ **Total wire length: 400 m or less**
(The wire length between indoor units should be 200 m or less.)

■ **Number of connectable units**

Remote controller and receiver: Max. 2, Indoor unit: Max. 8

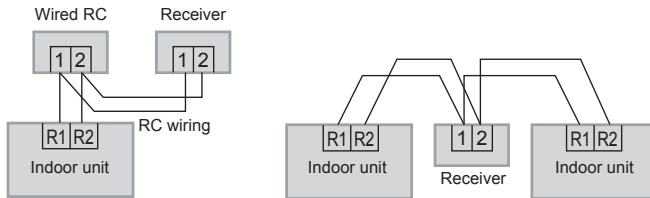


Attention

- Be careful not to connect cables to other terminals of indoor units (e.g. power source wiring terminal). Malfunction may occur.
- Do not bundle together with the power source wiring or store in the same metal tube. Operation error may occur.
- If noise is induced to the unit power supply, attach a noise filter.

- For the RC wiring of field supply, please use insulated wires with sheath. The insulation thickness should be at least 1 mm.
- Regulations on wire diameters differ from locality to locality. For field wiring rules, please refer to your LOCAL ELECTRICAL CODES before beginning.
- You must ensure that installation complies with all relevant rules and regulations.

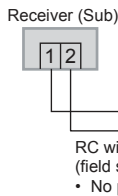
*Wiring as shown below is prohibited.



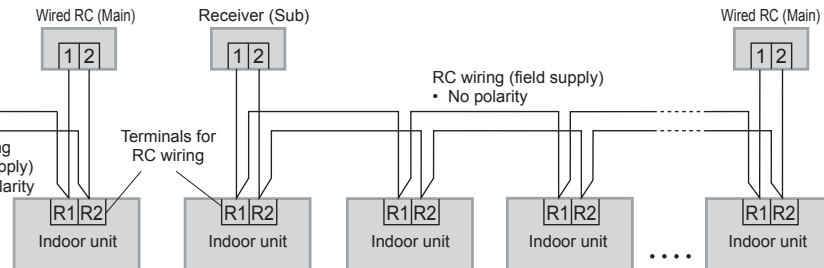
Installation when setting Main/Sub for the remote controller and the receiver

■ **Using 1 indoor unit**

Installation example



■ **Using more than 1 indoor unit**



After installation, according to the "Main/Sub setting" in the "Setting" section, set one to [Main] and the other to [Sub].
Setting the wired remote controller to [Main] is recommended.

Note

The remote controller and the receiver can be connected to any indoor unit for operation.

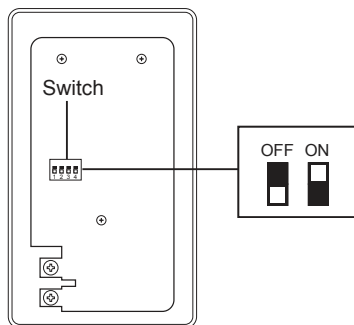
Specifications

Model No.	CZ-RWSC3, CZ-RWRC3
Dimensions	(H) 120 mm × (W) 70 mm × (D) 20 mm
Weight	75 g
Temperature/Humidity range	0 °C to 40 °C / 20 % to 80 % (No condensation) *Indoor use only.
Power Source	DC16 V (supplied from indoor unit)

4. Setting Address Switches

- Main/Sub setting
- Address setting

Remove the top case of the receiver for setting.



Main/Sub setting

- Use this to set Main/Sub for the remote controller and the receiver.
- Set one to [Main] and the other to [Sub].
- Factory default: [Main]
- It is recommended to set the wired remote controller to [Main].

Main/Sub	MAIN	SUB
Main/Sub switch position	 1 2 3 4	 1 2 3 4

Address setting

- When more than 1 receiver is installed in the same room, setting addresses prevents interference.
- For how to change addresses of wireless remote controllers, see operating instructions of wireless remote controllers.

Wireless remote controller address display	Address	Address	Address	Address	Address	Address	Address
	ALL	1	2	3	4	5	6
Address switch position	Receiving is possible at all address positions.						
		1 2 3 4	1 2 3 4	1 2 3 4	1 2 3 4	1 2 3 4	1 2 3 4

5. Test operation

Preparation : Turn on the circuit breaker of units and then turn the power on. After the power is turned on, remote controller operation is ignored for approx. 1 minute because setting is being made. This is not malfunction. (Contents received while setting are disabled.)

1. To start test operation, press and hold the emergency operation button for 10 seconds.
2. The indication lamps (OPERATION, TIMER, STANDBY) blink during test operation.
3. To finish test operation, press and hold the emergency operation button for 10 seconds.

Attention

- Do not use this mode for purposes other than the test operation. (To prevent overload of the units)
- Read the installation instructions supplied with the units.
- Any of the Heat, Cool and Fan operations can only be performed.
- Temperature cannot be changed.
- The test operation mode is automatically turned off in 60 minutes. (To prevent continuous test operation)
- Outdoor units do not operate for approx. 3 minutes after the power is turned on or operation is stopped.

Self-diagnostics table and detected contents

- The "Alarm Display" as shown in the table below expresses the alarm contents displayed when the wired remote controller is connected. For how to handle the alarms, see installation instructions of indoor units or technical guide.

Detected contents	Alarm Display	Indication lamp on the receiver			
		OPERATION	TIMER	STANDBY	Blinking
Communication error in the remote controller circuit	E01-E03, E08-E14, E17, E18	□	●	●	
Communication error either in the in/outdoor operation line or the sub-bus of the outdoor unit	E04-E07, E15, E16, E19-E31	●	●	□	
Operation of indoor protection device	P01, P09-P14	●	□	□	Alternately
Operation of outdoor protection device	P02-P08, P15-P31	□	●	□	Alternately
Error in the indoor thermistor	F01-F03, F10-F11	□	□	●	Alternately
Error in the outdoor thermistor	F04-F09, F12-F28	□	□	○	Alternately
Error in the indoor EEPROM	F29	□	□	●	Simultaneously
Error in the outdoor EEPROM	F30, F31	□	□	○	Simultaneously
Error related to the compressor	H01-H31	●	□	●	
Error in indoor settings	L01-L03, L05-L09	□	●	□	Simultaneously
Error in outdoor settings	L04, L10-L31	□	○	□	Simultaneously
Inconsistency in Air/Heat (Including an auto-temp setting for a model without auto-temp settings)		○	□	□	Alternately
Oil Alarm (Same as operation of outdoor protection device)		□	●	□	Alternately
Test operation		□	□	□	Simultaneously

●: OFF ○: ON (Illuminated) □: Blinking (0.5 seconds interval)

8-35. Common to All Models

1. The Self-Diagnosis Function Display and What is Detected


- The “Alarm Display” shown in the table below expresses the alarm contents displayed when the wired remote controller is connected. For how to handle the alarms, see installation instructions of indoor units, “Service Manual”, “Test Run Service Manual”.

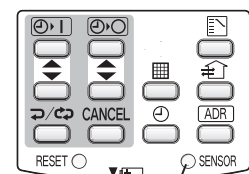
Detected contents	Alarm Display	Indication lamp on the receiver			Blinking
		OPERATION	TIMER	STANDBY	
Communication error in the remote controller circuit	E01–E03, E08–E14, E17, E18	○	●	●	
Communication error either in the in/outdoor operation line or the sub-bus of the outdoor unit	E04–E07, E15, E16, E19–E31	●	●	○	
Operation of indoor protection device	P01, P09–P14	●	○	○	Alternately
Operation of outdoor protection device	P02–P08, P15–P31	○	●	○	Alternately
Error in the indoor thermistor	F01–F03, F10–F11	○	○	●	Alternately
Error in the outdoor thermistor	F04–F09, F12–F28	○	○	○	Alternately
Error in the indoor EEPROM	F29	○	○	●	Simultaneously
Error in the outdoor EEPROM	F30, F31	○	○	○	Simultaneously
Error related to the compressor	H01–H31	●	○	●	
Error in indoor settings	L01–L03, L05–L09	○	●	○	Simultaneously
Error in outdoor settings	L04, L10–L31	○	○	○	Simultaneously
Error in the gas heat pump air conditioner	A01–A31	●	○	○	Simultaneously
Inconsistency in Cooling/Heating (Including an auto-temp setting for a model without auto-temp settings)		○	○	○	Alternately
Oil alarm (Same as operation of outdoor protection device)		○	●	○	Alternately
Auto addressing in progress (when it is performed with an infrared remote controller)					Sequentially
Test operation		○	○	○	Simultaneously

● : OFF ○ : ON (Illuminated) ○ (with dot) : Blinking (0.5 seconds interval)

2. Room Temperature Sensor Settings

Only available to CZ-RWSK2, CZ-RWSU3

- The indoor unit and the wireless remote controller are equipped with room temperature sensors. The sensing of room temperature works via one of them.
- When the unit is shipped, it is set to the indoor unit. To switch it to the remote controller, press the sensor button (the figure on the right) inside the remote controller’s cover and then check that Main Sensor  on the LCD screen goes off.



Sensor button

NOTE

Be sure to install the remote controller so as to face the receiver.

If the unit does not receive any room temperature data from the remote controller for ten minutes even with its sensing function activated, the indoor unit sensor will automatically start sensing the room temperature.

3. Setting Up Remote Controller Functions

The functions of the wireless remote controller can be set on site.

(These settings are saved in nonvolatile memory in the remote controller. Therefore, the settings do not revert to the defaults even when its batteries are changed.)

NOTE

Only service personnel should make the settings because the operation of the air conditioner may be affected, depending on the settings made.

Furthermore, making changes to these settings may cause actual operation to deviate from what is printed in the Operating Instructions, so be sure to fully explain this to the customer.

Infrared Remote Controller

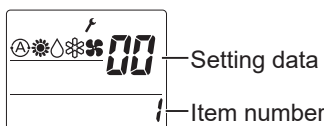
CZ-RWS3

Miscellaneous Settings

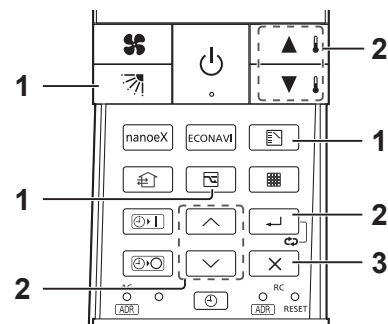
- These settings are saved in nonvolatile memory in the remote controller, so even when its batteries are changed, the settings do not have to be made again.
- Furthermore, making changes to these settings may cause actual operation to deviate from what is printed in the Operating Instructions, so be sure to fully explain this to the customer.
- Do not change any settings other than those items in table below.

1. Press , and at the same time for 4 seconds or longer when the unit is stopped (displaying the current time only).

- “” starts blinking and the setting screen is displayed.



2. Press / to select item number, press / to select setting data, and press .



3. Press .

Item Number	Setting item	Setting data	Factory setting	Check
1	Operation Mode ¹	00: / / / / / 01: / / / 02: / / / 03: / / / 04: / / / / / 05: / / / / /	00: / / / / /	
2	Flap Display	00: 5 levels (Cool in 5 levels) + Swing + Stop 01: 5 levels (Cool in 3 levels) + Swing + Stop 02: 5 levels (Cool in 3 levels) + Swing 03: Swing 04: No switchable function	00: 5 levels (Cool in 5 levels) + Swing + Stop	
3	Select Fan Speed	00: 5 levels (1 to 5, Auto) 01: 3 levels (Low (1), Medium (3), High (5), Auto) 02: 3 levels (Low (1), Medium (3), High (5)) 03: Low (1), Medium (3) 04: No switchable function	00: Speed 5 (1 to 5, Auto)	
4	Temperature Display	00: °C 01: °F	00: °C	
5	Clock Display	00: 24-hour 01: AM/PM	00: 24-hour	
6	Ventilation Fan Setting ²	00: Off 01: On	00: Off	
7	Cool Temp Max	5 – 35°C	30	
8	Cool Temp Min	5 – 35°C	18	
9	Heat Temp Max	5 – 35°C	30	
10	Heat Temp Min	5 – 35°C	16	
11	Dry Temp Max	5 – 35°C	30	
12	Dry Temp Min	5 – 35°C	18	
13	Auto Temp Max	5 – 35°C	27	
14	Auto Temp Min	5 – 35°C	17	
18	Energy Saving Setting ²	00: Off 01: On	01: On	
19	ECONAVI Setting ²	00: Off 01: On	01: On	
20	nanoe™ X Setting ²	00: Off 01: On	01: On	

¹*1 Set to [02: / / /] or [03: / / /] if you are using the unit only for cooling.







²*2 Press the function setting button for 4 seconds or longer while current time is displayed to switch the function On/Off.

Note

Make sure to fill the setting status in the check column after making changes to these settings.

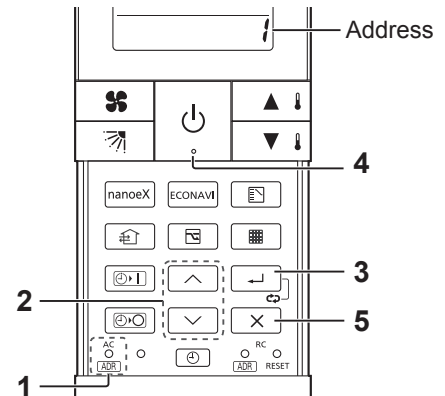
Auto Address


Set the Auto Address for each O/D unit no. (outdoor unit number) Select the O/D unit no. for Auto Address.

1. Press  for 4 seconds or longer.
 - “” starts blinking and the setting screen is displayed.
2. Press   to select the unit number (O/D unit no.) from 1 to 30.
3. Press  to set the Auto Address.
4. Press  to check the Auto Address status.


(Refer to the following table for the Auto Address status.)

 - Proceed to step 5 when the status is “Completion” or “Error” .
 - If “Running” keeps for 10 minutes or longer, check the unit number.



Auto Address Status	Buzzer of the receiver	Indication lamp on the receiver		
		OPERATION	TIMER	STANDBY
Running	2 times			
Completion	1 time	-	-	-
Error	5 times	●	●	◎

● : OFF, ○ : ON (Illuminated), ◎ Blinking (0.5 seconds interval)

5. Press  for 4 seconds or longer to exit the Auto Address setting.
 - Auto Address setting is canceled while running or error occurring.
 - Set the Auto Address again after resolve the error cause if an error occurs.

Attention

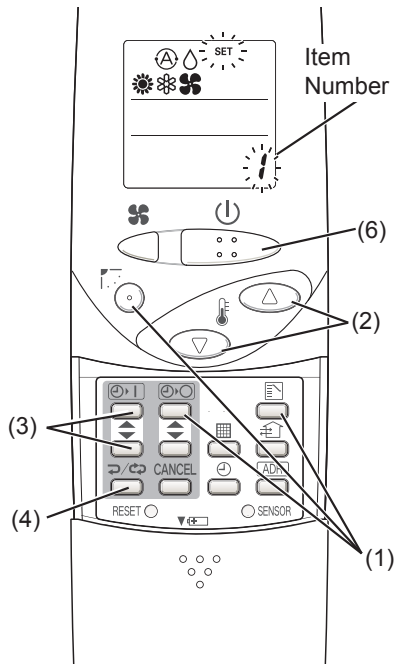
- Set Auto address after all units are turned on and 90 seconds or more have passed.
- Operate the units after Auto address is set and 90 seconds or more have passed.

Making Settings (Do with unit stopped)

Only available to CZ-RWSK2, CZ-RWSU3

- (1) Holding down the swing/flap (⏏) + OFF timer (⏏) + mode select (⏏) buttons at the same time for 4 or more seconds will open the setting screen. (See figure below.)
- (2) Use the Temperature setting buttons (⬆) / (⬇) (°) to select the number of the item to be set.
- (3) Use the ON timer buttons (⬆) / (⬇) (⏏) to change settings.
- (4) The settings are saved with the once/every day button (⏏). When this is done, the SET displayed on the LCD changes from blinking to lighting.
- (5) If other settings are to be changed, repeat steps (2) to (4).
- (6) When all settings have been made, press the start/stop (⏏) button.

Operation procedure and function display



Detected contents	Set Contents	Factory setting
1 Operation Mode	⏏ → ⏏ → ⏏ → ⏏ → ⏏ → ⏏ → ⏏	⏏
2 Flap Display	⏏ → ⏏ → ⏏ → (No Display) (*1)	⏏
3 Select Fan Speed	⏏ → ⏏ → ⏏ → (No Display)	⏏
4 Display of Set Temperature	°C → °F → Setting Off (*2)	°C
5 Time Display	24 Hour (No Display) → AM/PM	24 Hour
6 Ventilation Fan ON/OFF	OFF (No Display) → ON	OFF (*3)
7 Cool temp Max	05 to 35°C	30
8 Cool temp Min	05 to 35°C	18
9 Heat temp Max	05 to 35°C	30 (*4)
10 Heat temp Min	05 to 35°C	16
11 Dry temp Max	05 to 35°C	30
12 Dry temp Min	05 to 35°C	18
13 Auto temp Max	05 to 35°C	27
14 Auto temp Min	05 to 35°C	17
15 Address Setting Max Value	00 (ALL only) → 01 to 031	06 (*5)
16 Heat temp Max ON/OFF	JP (Heater Max Temp Change Off) → EP (ON)	JP

Attention

- *1 While the unit is in the SWING mode (swing/flap), the flap cannot be stopped in a desired position.
- *2 When Setting OFF is selected, "°C" is displayed on the LCD.
- *3 You can toggle between ON and OFF by pressing ventilation "(⏏)" button for 4 seconds or more.
- *4 If the Heater Max ON/OFF setting is not changed to EP (ON), the setting change will not be reflected.
- *5 This is the number of addresses that can be set in the address change mode. Do not set it to 07 or above.

■ Test Operation

Preparation: Turn on the circuit breaker of units and then turn the power on. After the power is turned on, remote controller operation is ignored for approx. 1 minute because setting is being made.

This is not malfunction. (Contents received while setting are disabled.)

1. To start test operation, press and hold the emergency operation button for 10 seconds.
2. The indication lamps (OPERATION, TIMER, STANDBY) blink during test operation.
3. To finish test operation, press and hold the emergency operation button for 10 seconds.

Attention

- Do not use this mode for purposes other than the test operation.
(To prevent overload of the units)
- Read the installation instructions supplied with the units.
- Any of the Heat, Cool and Fan operations can only be performed.
- Temperature cannot be changed.
- The test operation mode is automatically turned off in 60 minutes.
(To prevent continuous test operation)
- Outdoor units do not operate for approx. 3 minutes after the power is turned on or operation is stopped.

