

New commercial range
2021 / 2022

Bringing nature's
balance indoors





Panasonic Commercial air to air

Here are some of your new air conditioner's major features.

Panasonic has developed an impressive range of highly efficient Commercial Air Conditioners. This range confirms our commitment to the environment, with our highly efficient inverter compressor technology to optimise performance.

Highlighted features	→ 4
New PACi NX Series	→ 6
Bringing nature's balance indoors	→ 8
New 4 way 90x90 cassette - PU3	→ 10
New adaptive ducted unit - PF3	→ 11
PACi NX: Excellent SEER and SCOP	→ 12
Solutions for 24/7/365 applications	→ 13
Commercial units range	→ 14
Elite - Standard wall-mounted • R32	→ 16
Elite and Standard 4 way 60x60 cassette • R32	→ 20
Elite - Standard 4 way 90x90 cassette • R32	→ 22
Elite - Standard ceiling • R32	→ 26
Elite - Standard adaptive ducted unit • R32	→ 30
High static pressure hide-away 20,0-25,0 kW • R32	→ 34
Commercial PACi NX Multi	
PACi NX single, twin, triple and double-twin systems • R32	→ 36



Quality Management System Certificate



ISO 9001: 2015
Panasonic Appliances Air-Conditioning
Malaysia Sdn.Bhd.
Cert. No.: AR 1010



GB/T 19001-2016/ISO 9001: 2015
Panasonic Appliances Air-Conditioning
(GuangZhou) Co., Ltd.
Registration Number: 01218Q30835R8L

Environmental Management System Certificate

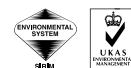

ISO 14001: 2015
Panasonic Appliances Air-Conditioning
Malaysia Sdn.Bhd.
Cert. No.: EMS 00109



GB/T 24001-2016/ISO 14001: 2015
Panasonic Appliances Air-Conditioning
(GuangZhou) Co., Ltd.
Registration Number: 02118E10944R7M

Highlighted features

PACi: Commercial air to air. The compact and high efficiency solution for shops, restaurants, offices or residential applications.

Great savings and improved comfort. Panasonic has developed an impressive range of highly efficient Commercial air conditioners, with our highly efficient inverter compressor technology to optimise performance.



A wide range for industry, office or residential application. With configuration from 1:1 to 4:1, Panasonic can offer the most comfortable climate with solutions designed for every environment.

The diverse array of connectivity and control systems, allows you to manage your units from any various locations. Receive real-time status updates and maintenance alerts, while optimizing costs and energy usage.

Energy saving



Refrigerant gas R32. Our heat pumps containing the refrigerant R32 show a drastic reduction in the value of Global Warming Potential (GWP).



Econavi. Intelligent Human Activity Sensor and new Sunlight Sensor technologies that can detect and reduces the waste of energy by optimising air conditioner operation according to room conditions. With just one touch of a button, you can save energy.



Exceptional Seasonal Cooling Efficiency based on the new ErP regulation. Higher SEER ratings mean greater efficiency - year-round cooling savings!



Exceptional Seasonal Heating Efficiency based on the new ErP regulation. Higher SCOP ratings mean greater efficiency - year-round heating savings!



Inverter Plus System classification highlights Panasonic's highest performing systems.



High efficiency compressor. Compressors that operate with a wider Hz range realize a more efficient operation throughout the year. For Big PACi Series.

High performance and indoor air quality



Down to -15 °C in cooling mode. The air conditioner works in cooling mode when the outdoor temperature of -15 °C.



Down to -20 °C in heating mode. The air conditioner works in heat pump mode when the outdoor temperature is as low as -20 °C.



nanoe™ X. Technology with the benefits of hydroxyl radicals has the capacity to inhibit pollutants, viruses, and bacteria to clean and deodorise.



Bluefin. Panasonic has extended the life of its condensers with an original anti-rust coating.



Large fan provides larger air flow rate and very quiet operation at low speed.



DC fan: Safe and precise.



Filter included. Hide-away with filter included.



Super Quiet. With Super Quiet technology our devices are quieter than a library [30 dB(A)].



R410A/R22 renewal. The Panasonic renewal system allows good quality existing R410A or R22 pipe work to be re-used whilst installing new high efficiency R32 systems.

High connectivity



Panasonic AC Smart Cloud. The AC Smart Cloud from Panasonic allows you to have complete control of all your installations. In a simple click, receive status updates from all your units in real-time, preventing breakdowns and optimizing costs.



Internet control. A next generation system providing user-friendly remote control of air conditioning or heat pump units from everywhere, using a simple Android™ or iOS smartphone, tablet or PC via the internet.



Connectivity. The communication port can be integrated into the indoor unit and provides easy connection to, and control of, your Panasonic heat pump to your home or building management system.



5 Years compressor warranty. We guarantee the outdoor unit compressors in the entire range for five years.

Professional air conditioners with R32 refrigerant

Panasonic recommends R32, with lower Global Warming Potential (GWP). Compared to R22 and R410A, R32 has a very low potential impact on global warming.

Panasonic takes action for the environment. In line with the European countries participating in the Montreal Protocol, protecting the ozone layer and preventing global warming, Panasonic is leading the switch to R32.

1 Installation innovation

- Extremely easy to install, practically the same as R410A
- Single substance refrigerant, which makes it easier to recycle and reuse

2 Environmental innovation

- Zero impact on the ozone layer
- 75 % less impact on global warming

3 Economic and energy consumption innovation

- Lower cost and greater savings
- Higher energy efficiency than R410A



PACi NX Elite: Top-tier commercial air conditioning

Outstanding performance at extreme ambient temperatures with very high energy efficiency both in heating and cooling. Fans, fan motors, compressors and heat exchangers engineered for maximum savings result in higher seasonal efficiencies, which ranks as one of the best in the industry, ensuring reduced CO₂ emissions, energy consumption and operating costs.

From 3,6 to 14,0 kW.

- Meeting all necessary safety approvals to ensure quality and safety
- Top class SEER: A+++ / SCOP: A+++ at 3,6 kW (in 90x90 cassette)

- Cooling operation is possible when outdoor temperature as high as 48 °C (for PACi NX 7,1 kW and higher capacities)
- Precise control with DC inverter technology for even more energy saving
- Cooling operation at -20 °C (10,0 kW to 14,0 kW with 30 m maximum pipe length)
- Heating operation at ambient temperature as low as -20 °C
- Compact outdoor units
- Auto restart after power outage
- Twin, triple and double-twin connections

PACi NX Standard: For economy and value

With high quality design and engineering, the PACi and PACi NX Standard are the perfect solutions for projects which demand quality on a limited budget. In addition, compact and lightweight design makes them ideal for installations with limited space including small commercial and residential applications. The slim and lightweight outdoor unit design enables installation even at very challenging locations.

From 3,6 to 14,0 kW.

- Extended range of outdoor units starting from 3,6 kW

- Good balance of system cost vs performance
- Top class SEER/SCOP in the standard inverter category SEER: A++ / SCOP: A++ up to 7,1 kW (in 90x90 cassette)
- Variety of individual and central controllers which provides full flexibility
- Compact outdoor units, small footprint and lightweight
- Twin connection possible
- Cooling operation down to -10 °C and heating operation down to -15 °C

Big PACi Elite R32

20,0 – 25,0 kW is ideally suited for small and mid retail applications.

In addition to its lightweight, split-able, compact body, the newly designed hide-away unit enables easy installation and pipe work within a narrow void.

Panasonic Big PACi : Environmental friendly, strong and flexible.

- High efficiency with Panasonic compressor as the driving force

- Compact and light indoor body
- Easy pipe work with split-able hide-away indoor design
- Separable indoor unit allows for flexible installation to fit in narrow void
- Water heat exchanger and AHU connection compatibility
- Bluefin anti-corrosion coating of the heat exchanger as standard
- Wide range of controls including Cloud Control compatibility

New PACi NX Series. The next generation is here

NX Series with R32 refrigerant has been developed to meet the demand of easy refurbishment with 3 wired method.

Also integrated with IoT solutions and includes nanoe™ X function as standard.

NEW
SERIES
2021



1 PACi NX Series - Standard range, for absolute ease of refurbishment

This new series has been developed with 3 wired method and communication. It makes it simple and easy to replace old systems with 3 wire connections, which is prevalent in many systems.

PACi PZ2/PZH2: 2 wire method.

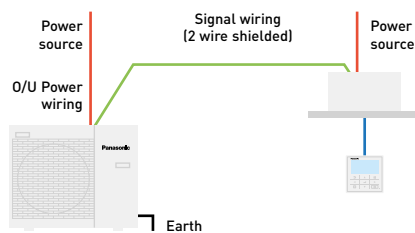

New PACi NX Series: 3 wire method.

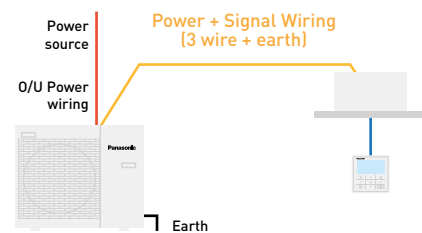

2 CONEX with IoT integration

The new wired remote controller series is fully integrated with IoT solutions developed by Panasonic. Detailed operation, maintenance setting and service operation are all possible with smartphone or tablet.

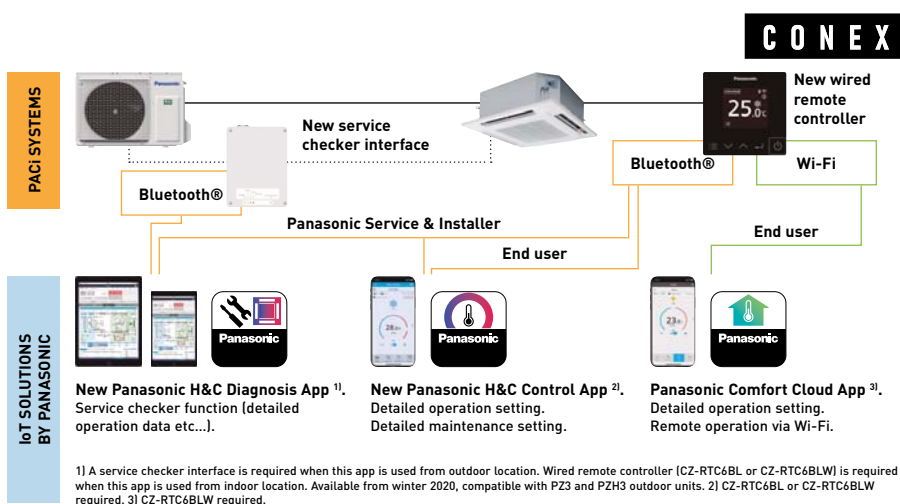

3 Let Panasonic take care of indoor air quality

Thanks to the nanoe™ X properties, several types of pollutants can be inhibited such as certain types of bacteria, viruses, mould, allergens, pollen and certain hazardous substances. This unique technology is equipped to provide better air quality whether residential or commercial.



7 effects of nanoe™ X – Panasonic unique technology.

Deodorises	Capacity to inhibit 5 types of pollutants					Moisturises
Odours	Bacteria and viruses	Mould	Allergens	Pollen	Hazardous substances	Skin and hair

* Refer to <https://aircon.panasonic.eu> for more details and validation data.

4 Increasing the efficiency

The new PACi NX Series have improved seasonal efficiencies in both heating and cooling versus the previous generation.

kW	4 way cassette - PU3				Adaptive ducted - PF3			
	Elite		Standard		Elite		Standard	
	SEER/ηsc	SCOP/ηsh	SEER/ηsc	SCOP/ηsh	SEER/ηsc	SCOP/ηsh	SEER/ηsc	SCOP/ηsh
3,6	A+++	A+++	A++	A++	A++	A+	A+	A+
5,0	A++	A++	A++	A++	A++	A++	A++	A+
6,0	A++	A++	A++	A++	A++	A++	A++	A++
7,1	A++	A++	A++	A++	A++	A++	A++	A+
10,0	A++	A++	A++	A+	A++	A+	A++	A
12,5	304,3 %	186,0 %	267,1 %	157,3 %	281,7 %	170,0 %	257,5 %	144,2 %
14,0	286,6 %	181,2 %	257,3 %	152,4 %	275,9 %	171,0 %	252,6 %	140,8 %

* Energy label scale from A+++ to D for models below 12,0 kW (EU regulation 626/2011).
* ηsc / ηsh values for models above 12,0 kW (EN 14825).

New 4 way 90x90 cassette - PU3

- Always fresh and clean air with nanoe™ X and internal cleaning mode
- A modern flat panel design to blend into any space
- High seasonal efficiency, maximum SEER/SCOP = A+++/A+++
- Advanced comfort and energy saving by Econavi sensor

New adaptive ducted - PF3

- Better indoor air quality with nanoe™ X even with long ducts
- High flexibility with a complete new design which allows vertical or horizontal installation
- High seasonal performance in a slim body
- Super quiet operation, minimum 22 dB(A)

Bringing nature's balance indoors



nanoe™ X, technology with the benefits of hydroxyl radicals.

Abundant in nature, hydroxyl radicals (also known as OH radicals) have the capacity to inhibit pollutants, viruses, and bacteria to clean and deodorise. nanoe™ X technology can bring these incredible benefits indoors so that hard surfaces, soft furnishings, and the indoor environment can be a cleaner and pleasant place to be.



Panasonic's nanoe™ X technology takes this a step further and brings nature's detergent – hydroxyl radicals – indoors to help create an ideal environment

Thanks to the nanoe™ X properties, several types of pollutants can be inhibited such as certain types of bacteria, viruses, mould, allergens, pollen and certain hazardous substances.

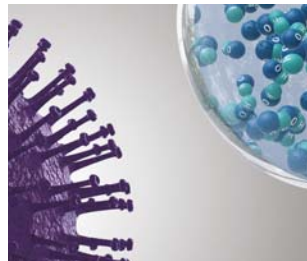

1 | nanoe™ X reliably reaches pollutants.

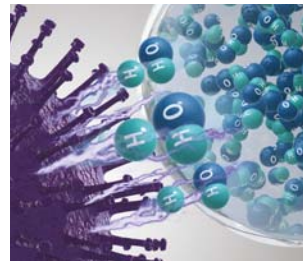

2 | Hydroxyl radicals denature pollutants' proteins.

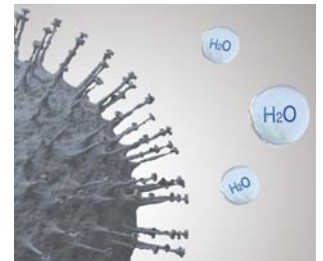

3 | Pollutants activity is inhibited.

What is unique about nanoe™ X?

Effective on fabrics and surfaces.

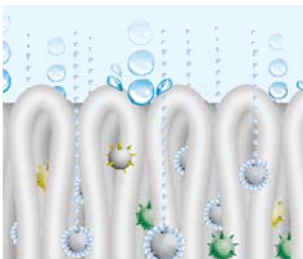

1 | At one billionth of a metre, nanoe™ X is much smaller than steam and can deeply penetrate cloth fabrics to deodorise.

Longer lifespan.



2 | Contained in tiny water particles, nanoe™ X has a longer lifespan to spread easily around the room.

Huge quantity.



3 | nanoe X Generator Mark 2 produces 9,6 trillion hydroxyl radicals per second. Greater amounts of hydroxyl radicals contained in nanoe™ X lead to higher performance on inhibition of pollutants.

Maintenance-free.



The image shows nanoe X Generator Mark 2.

4 | No maintenance, no replacement required. nanoe™ X is a filter free solution that does not require maintenance, as its atomisation electrode is enveloped with water during its generation process and it is made with Titanium.

7 effects of nanoe™ X – Panasonic unique technology

Deodorises



Odours

Capacity to inhibit 5 types of pollutants



Bacteria and viruses



Mould



Allergens



Pollen



Hazardous substances



Skin and hair

* Refer to <https://aircon.panasonic.eu> for more details and validation data.

nanoe™ X, internationally-validated technology in testing facilities

The effectiveness of nanoe™ X technology has been tested by 3rd party laboratories in Germany, France, Denmark, Malaysia and Japan.

The nanoe™ X performance varies depending on the room size, environment and usage and it may take several hours to reach the full effect. nanoe™ X is not medical device, local regulations on building design and sanitary recommendations must be followed.

Test results conducted under controlled laboratory conditions. Performance of nanoe™ X might differ in real life environment.

	Tested contents		Result	Capacity	Time	Testing organisation	Report No.
Airborne	Virus	Bacteriophage ΦX174	99,7 % inhibited	Approx. 25 m³	6 h	Kitasato Research Center for Environmental Science	24_0300_1
	Bacteria	Staphylococcus aureus	99,9 % inhibited	Approx. 25 m³	4 h	Kitasato Research Center for Environmental Science	2016_0279
Adhered	Virus	SARS-CoV-2	91,4 % inhibited	6,7 m³	8 h	Texcell (France)	1140-01 C3
		SARS-CoV-2	99,9 % inhibited	45 L	2 h	Texcell (France)	1140-01 A1
		Xenotropic murine leukemia virus	99,999 % inhibited	45 L	6 h	Charles River Biopharmaceutical Services GmbH	—
		Influenza (H1N1 subtype)	99,9 % inhibited	1 m³	2 h	Kitasato Research Center for Environmental Science	21_0084_1
		Bacteriophage ΦX174	99,80% inhibited	25 m³	8 h	Japan Food Research Laboratories	13001265005-01
	Bacteria	Staphylococcus aureus	99,9 % inhibited	20 m³	8 h	Danish Technological Institute	868988
	Pollen	Ambrosia pollen	99,4 % inhibited	20 m³	8 h	Danish Technological Institute	868988
	Odours	Cigarette smoke odour	Odour intensity reduced by 2,4 levels	Approx. 23 m³	0,2 h	Panasonic Product Analysis Center	4AA33-160615-N04

First nanoe™ device was developed by Panasonic in 2003

	nanoe™	nanoe™ X	
Generator	2003	Mark 1 - 2016	Mark 2 - 2019
	480 billion hydroxyl radicals/sec	4,8 trillion hydroxyl radicals/sec	9,6 trillion hydroxyl radicals/sec
Ion particle structure	 Hydroxyl Radicals	10x times	20x times

nanoe™ X: improving protection 24/7



Acts to clean your air, so that the indoor environment can be a cleaner and pleasant place to be all day long. nanoe™ X works together with heating or cooling function when the during the day and can work independently when the area is not occupied.

Give the air conditioning the strength to increase the protection of your indoor spaces with nanoe™ X technology and convenient control via the Panasonic Comfort Cloud App.

Cleans the air when you are away.

Leave the nanoe™ mode ON to inhibit certain pollutants and deodorise before you return home.

Improves your environment when you are at home.

Enjoy a cleaner, comfortable space with loved ones.



Panasonic Heating & Cooling Solutions is incorporating nanoe™ technology in a wide range of equipment



Wall-mounted.
Built-in nanoe X Generator Mark 2.



Ceiling.
Built-in nanoe X Generator Mark 2.



4 Way 90x90 cassette.
Built-in nanoe X Generator Mark 1.



Adaptive ducted unit.
Built-in nanoe X Generator Mark 2.

New 4 way 90x90 cassette - PU3

These cassettes offer upgraded nanoe™ X and Econavi technologies to make the room air more comfortable and healthy and to increase the energy efficiency.



1 Improved indoor air quality with nanoe™ X and fresh air intake

- nanoe™ X technology equipped as standard for improved indoor air quality
- Internal cleaning function for the unit with nanoe™ X
- High external fresh air intake volume with optional kit (CZ-FDU3 + CZ-ATU2)

2 Superior energy efficiency and comfort

- High seasonal efficiency both in heating and cooling, maximum SEER/SCOP = A+++/ A+++
- Econavi: Intelligent sensors to increase energy savings and comfort
- Super quiet operation down to 27 dB(A)

3 Easy installation

- Light weight, easy piping and integrated drain pump for quick installation
- New wired remote controller CZ-RTC6BL allows easy system setting via Bluetooth®

Always fresh and clean air with nanoe™ X

The 4 way 90x90 cassette with nanoe™ X, when tested, has shown to inhibit hazardous substances by 92 %, when compared to natural reduction*.

In addition to the 7 effects of nanoe™ X, the indoor unit can also be cleaned with a short operation of nanoe™ X + dry mode.

* Controllers (CZ-RTC5B or CZ-RTC6/BL/BLW) are required.

After cooling/drying operation, the inside of the indoor unit is automatically dried and nanoe™ X is activated to suppress mould growth and to reduce odour.

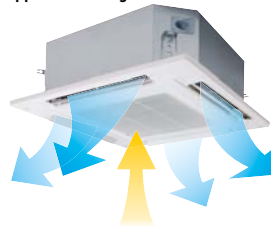

Operates the fan to discharge internal humidity.

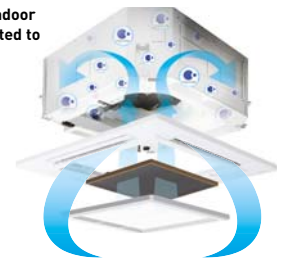

Operate the fan to circulate nanoe™ X internally.

nanoe™ X effect against odour proven in large space

92 % of hexadecane²⁾ is inhibited after 8-hours exposure in room side 267 m².

Hexadecane inhabitation ratio.

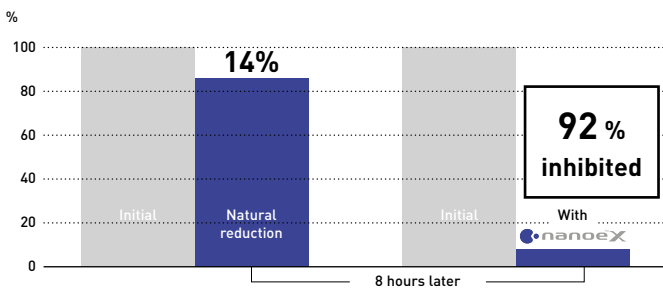

Test ambient.

3rd party certification organization SIRIM³⁾ conducted the performance experiment of 4 way cassette equipped with nanoe X Generator Mark 1 device in inhibiting hexadecane, a chemical contaminant.

²⁾ Hexadecane is a hazardous substance contained in gasoline and diesel exhaust gas, and considered to be one cause of oil odour. ³⁾ SIRIM Berhad (SIRIM), a premier industrial research and technology organization in Malaysia, wholly-owned by the Ministry of Finance Incorporated.

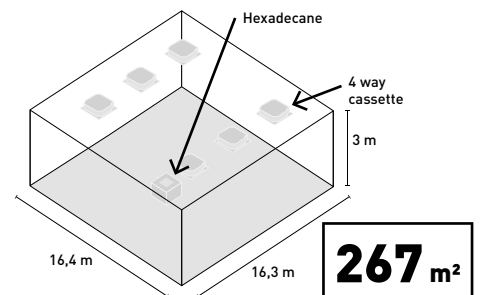

Optional Econavi intelligent sensor

Human activity sensor and floor temperature sensor can reduce waste energy, by optimising air conditioner operation.

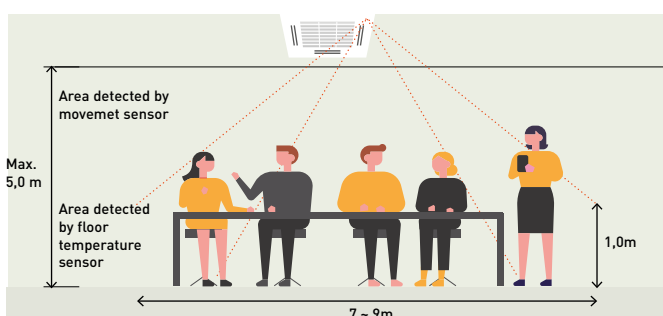

Advanced Econavi functions.

2 sensors (movement and floor temperature) can provide a reduction in wasted energy by means of effective control. The floor temperature can be detected with a ceiling height of 5 m.



Econavi exclusive panel. Optional (CZ-KPU3AW)



Floor temperature sensor.
This sensor detects average floor temperature and operates circulation if floor temperature is low.

Movement sensor.
This sensor detects the amount of human activity, and operates effectively.



Wired remote controller CZ-RTC5B or CZ-RTC6/BL/BLW is required.

New adaptive ducted unit - PF3

New adaptive ducted - PF3 has been completely re-designed to provide better flexibility. The vertical installation is newly available with powerful external static pressure (maximum 150 Pa).



<https://www.youtube.com/watch?v=LBiRrs0aqXo>

1 Highly flexible installation
2 installation possibilities (horizontal / vertical).

2 High seasonal performance with slim body
Maximum SEER/SCOP: A++/A++.

3 Comfort operation
Super quiet operation, minimum 22 dB(A)*.

* 3,6 kW model and when operating with external static pressure 50 Pa in low fan mode.

2 installation possibilities (horizontal / vertical)

Vertical installation is newly available. External static pressure 150 Pa, sufficient for remotely installing units away from the rooms.



Improved drain pan design

Just one drain pan for both horizontal and vertical installations. No need to modify the unit.

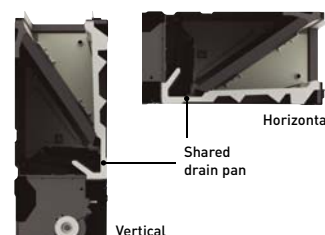

Selectable inlet air position

Inlet air position may be adjusted by means of a removable panel, to allow rear or bottom entry, depending on the duct installation.

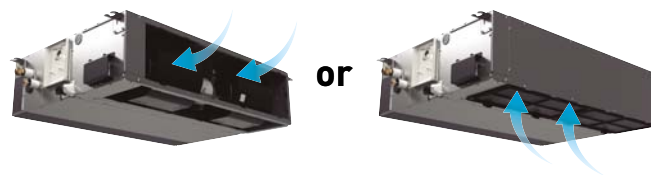

Maximum efficiency

	kW	3,6	5,0	6,0	7,1	10,0	12,5	14,0
Elite	SEER	A++	A++	A++	A++	A++	η_{sc} 281.7%	275.9%
	SCOP	A+	A+	A++	A++	A+	η_{sh} 170.0%	171.0%
Standard	SEER	—	—	A++	A++	A++	η_{sc} 257.5%	252.6%
	SCOP	—	—	A++	A+	A	η_{sh} 144.2%	140.8%

Compact body

- Only 250 mm high
- Light units from 25 to 39 kg

Conventional model	New adaptive ducted
33 kg	30 kg
290 mm	250 mm

New adaptive ducted



Better indoor air quality with nanoe™ X



The performance of nanoe™ X technology is maintained, even with 10 m long ducts*. The effect of improved air quality is sufficient to allow for numerous duct shapes to fit the application.

* Panasonic internal survey.

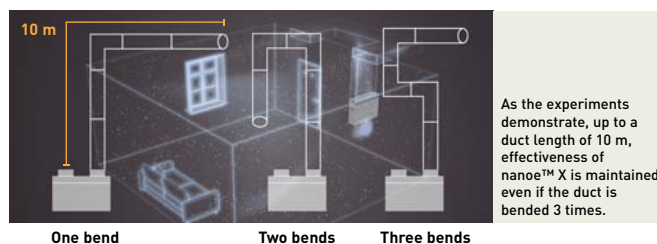

As the experiments demonstrate, up to a duct length of 10 m, effectiveness of nanoe™ X is maintained even if the duct is bended 3 times.

nanoe™ X effect against odour proven in large space

In a room of 139 m², tobacco odour is reduced by a factor of 0,7 when compared to natural reduction over a period of 2 hours.

Tobacco deodorisation ratio.

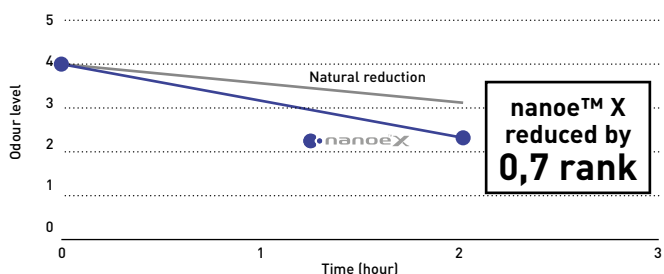

Test ambient.

3rd party international testing institute KAKEN¹⁾ conducted the performance experiment of Adaptive ducted equipped with nanoe X Generator Mark 2 device removing tobacco odour.

1) KAKEN TEST CENTER General Incorporated Foundation in Japan, international testing institute.

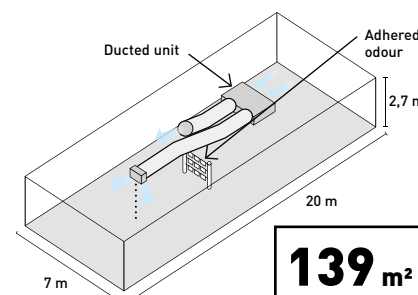

PACi NX: Excellent SEER and SCOP values

High operating efficiency using DC inverter compressor, DC motor and a heat exchanger design.

PACi NX R32 seasonal efficiency for daily energy saving

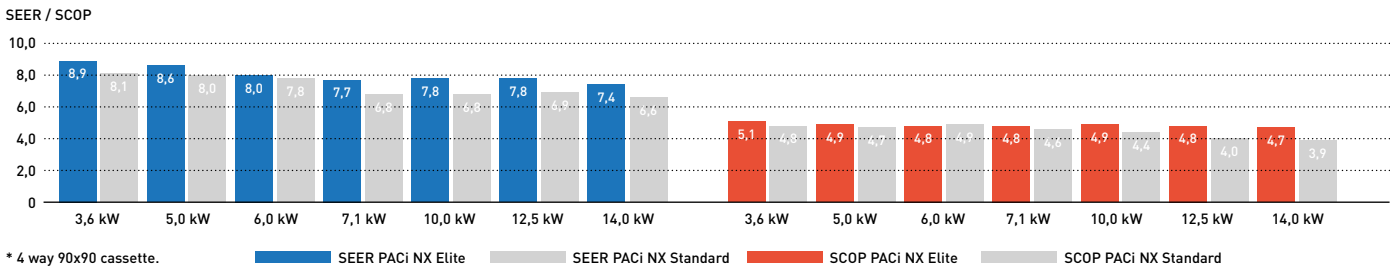

Increased piping length for greater design flexibility

Adaptable to various building types and sizes. Maximum piping length: 85 m (10,0, 12,5, 14,0 kW). 50 m (7,1 kW).

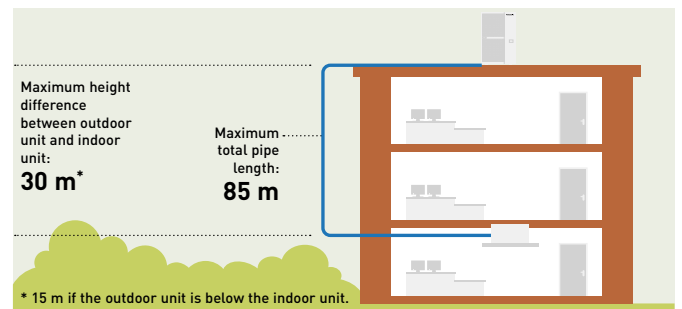

PACi NX Elite design operation conditions

PACi NX elite series are capable of working even in the most difficult ambient conditions. Cooling operation is possible when outdoor temperature is as low as -20 °C¹⁾ or as high as 48 °C²⁾. Heating operation can also be utilized at outdoor temperatures down to -20 °C when outdoor temperature is as low as -20 °C.

1) It is possible to operate at -20 °C only computer rooms with the piping length of 30 m or less.
2) Please check technical tables for further details on operating temperature.

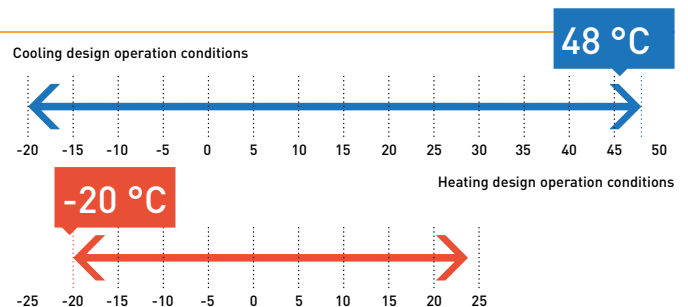

Compact & Flexible-design

The slim and lightweight design means the PACi outdoor unit can be installed in a number of compact situations. As the unit only weighs 99kg, it is easy to carry and easy to install.



Demand response compliant (CZ-CAPDC3) as a standard function

This terminal allows demand control of the outdoor unit. Several setting levels are available:

- Level-1, 2, 3: 75 / 50 / 0 %
- Level-1, 2 can be set in 40 - 100 % (40, 45, 50...95, 100: each 5 %)

CZ-CAPDC3 also allows for forced stop which can be used for fire-alarm connection on LV3.

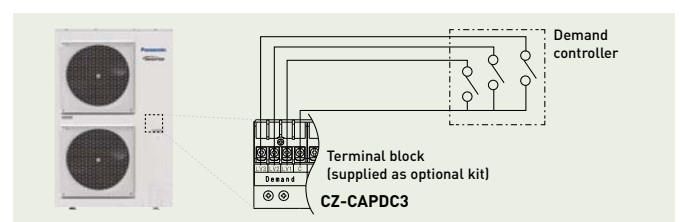

Solutions for 24/7/365 applications

High efficiency products for 24/7 applications. Panasonic has developed a complete range of solutions for server rooms which efficiently protect your servers, keeping them at an appropriate temperature even when the outdoor temperature is below -20 °C.



High efficiency all the year

Key points:

- From 2,5 to 7,1 kW with TKEA R32 refrigerant units A+++ in cooling
- PACi units from 3,6 to 14,0 kW
- Backup function
- Redundancy function
- Alternative run function
- Error information by Dry Contact
- Operation even at -20 °C outdoor temperature
- High seasonal performance
- Product design for 24/7 operation

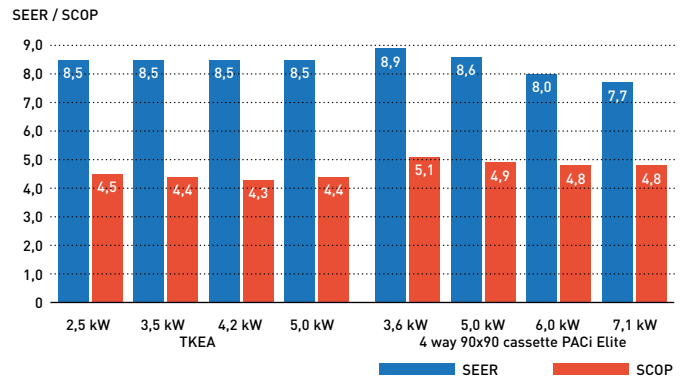

Interface to run 2 TKEA. PAW-SERVER-PKEA

The PAW-SERVER-PKEA server room interface manages redundancy and backup of two TKEA units with two different selectable modes:

- Plug and play by embedded redundancy and backup algorithm (no external signal needed. Further details please refer to operation manual)
- External (third party PLC) redundancy and backup management by Dry Contact

All settings are possible without the need for a computer connection.

A special Energy Saving Mode is selectable by deep switch (available only in plug and play mode). The level of remote control input prohibition can be set when external management is by Dry Contact.

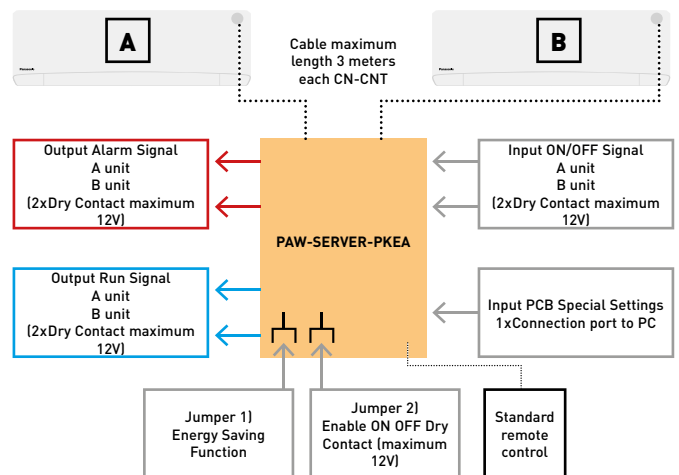

Interfaces to run 2 or 3 PACi and VRF indoor units

PAW-PACR3.

In combination with one PAW-T10 on each indoor unit, allows the redundant operation of 2 (or 3) PACi or VRF indoor units.

All units will be operated sequentially in order to achieve the same operating time (example turn every 8 hours within a 24 hour period).

If the room temperature exceeds a freely set value, the 2nd (or 3rd) unit will be switched ON and an alarm will be activated.

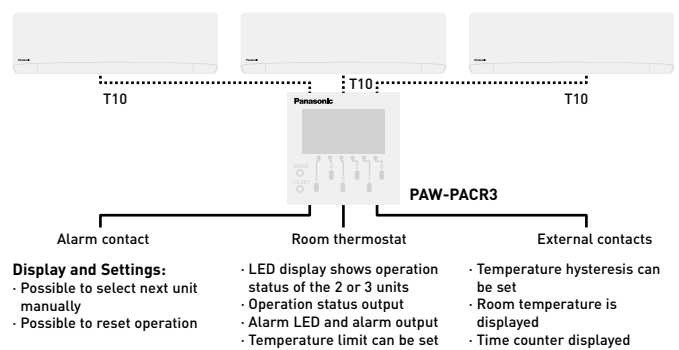

Backup control by using CZ-RTC5B.





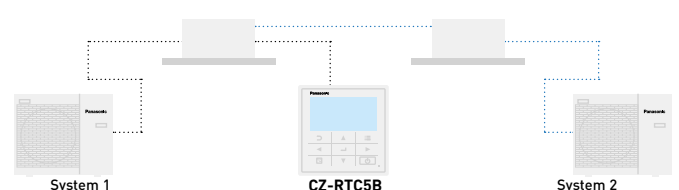





















Group wiring of 2 systems of PACi can do auto individual control.

- Rotation operation
- Backup operation
- Support operation



Commercial units range

NEW
2021

Page	Indoor units	2,5 kW	3,6 kW	4,5 kW ¹⁾	5,0 kW	6,0 kW
P. 16	NEW wall-mounted Inverter+ • R32					
			S-3650PK3E	S-3650PK3E	S-3650PK3E	S-6010PK3E
P. 20	NEW 4 way 60x60 cassette Inverter+ • R32 ²⁾					
		S-25PY3E	S-36PY3E	S-50PY3E	S-60PY3E	
P. 22	NEW 4 way 90x90 cassette Inverter+ • R32					
			S-3650PU3E	S-3650PU3E	S-3650PU3E	S-6071PU3E
P. 26	NEW ceiling Inverter+ • R32					
			S-3650PT3E	S-3650PT3E	S-3650PT3E	S-6071PT3E
P. 30	NEW adaptive ducted Inverter+ • R32					
			S-3650PF3E	S-3650PF3E	S-3650PF3E	S-6071PF3E
P. 34	High static pressure hide-away 20-25 kW Inverter+ • R32					
Outdoor units		2,5 kW	3,6 kW		5,0 kW	6,0 kW
PACi NX Elite • R32						
			U-36PZH3E5 / U-36PZH2E5 ³⁾		U-50PZH3E5 / U-50PZH2E5 ³⁾	U-60PZH3E5
PACi NX Standard • R32						
		U-25PZ3E5	U-36PZ3E5		U-50PZ3E5	U-60PZ3E5A

1) The 4,5 kW indoor capacity options are only available only for twin, triple and double-twin combinations. * U-__E5 Single phase / U-__E8 Three phase. 2) Available in Autumn 2021. 3) PZH2 models only for PY2 models.

7,1 kW

10,0 kW

12,5 kW

14,0 kW

20,0 kW

25,0 kW



S-6010PK3E



S-6010PK3E



S-6071PU3E



S-1014PU3E



S-1014PU3E



S-1014PU3E



S-6071PT3E



S-1014PT3E



S-1014PT3E



S-1014PT3E



S-6071PF3E



S-1014PF3E



S-1014PF3E



S-1014PF3E



S-200PE3E5B



S-250PE3E5B

7,1 kW

10,0 kW

12,5 kW

14,0 kW

20,0 kW

25,0 kW



U-71PZH3E5 / U-71PZH3E8



U-100PZH3E5 / U-100PZH3E8



U-125PZH3E5 / U-125PZH3E8



U-140PZH3E5 / U-140PZH3E8



U-200PZH2E8



U-250PZH2E8



U-71PZ3E5A



U-100PZ3E5 / U-100PZ3E8



U-125PZ3E5 / U-125PZ3E8



U-140PZ3E5 / U-140PZ3E8

NEW
2021

nanoe™ X

nanoe™ X as a standard.

NEW PACi NX Series Elite wall-mounted Inverter+ • R32

The wall-mounted units with stylish matt color can be offered for many applications such as studios, gyms, high ceiling areas and even computer server rooms. The compact design and flat face ensure discreet installation, even in a small space.



			Single phase				
			3,6 kW	5,0 kW	6,0 kW	7,1 kW	10,0 kW
Kit			KIT-36PK3ZH5	KIT-50PK3ZH5	KIT-60PK3ZH5	KIT-71PK3ZH5	KIT-100PK3ZH5
Remote controller			CZ-RTC5B	CZ-RTC5B	CZ-RTC5B	CZ-RTC5B	CZ-RTC5B
Cooling capacity	Nominal (Min - Max)	kW	3,6 (1,2 - 4,0)	5,0 (1,2 - 5,6)	6,1 (1,2 - 7,1)	7,1 (2,2 - 9,0)	9,5 (3,1 - 10,5)
EER ¹⁾		W/W	4,93 (5,45 - 4,49)	4,24 (5,45 - 3,61)	3,86 (5,45 - 3,02)	3,50 (5,79 - 2,69)	3,26 (5,34 - 3,09)
SEER ²⁾			8,4 A++	8,0 A++	7,2 A++	6,8 A++	6,4 A++
Pdesign		kW	3,6	5,0	6,1	7,1	9,5
Input power cooling		kW	0,73 (0,22 - 8,90)	1,18 (0,22 - 1,55)	1,58 (0,22 - 2,35)	2,03 (0,38 - 3,35)	2,91 (0,58 - 3,40)
Annual energy consumption ³⁾		kWh/a	150	219	297	365	520
Heating capacity	Nominal (Min - Max)	kW	4,0 (1,2 - 5,0)	5,6 (1,2 - 6,5)	7,0 (1,2 - 8,0)	8,0 (2,0 - 9,0)	9,5 (3,1 - 11,5)
COP ¹⁾		W/W	4,82 (5,45 - 4,17)	4,15 (5,45 - 3,55)	4,19 (5,45 - 3,40)	4,00 (5,56 - 3,16)	3,97 (5,54 - 3,43)
SCOP ²⁾			4,9 A++	4,7 A++	4,8 A++	4,7 A++	4,1 A+
Pdesign at -10 °C		kW	3,6	4,5	4,6	5,2	8,0
Input power heating		kW	0,83 (0,22 - 1,20)	1,35 (0,22 - 1,83)	1,67 (0,22 - 2,35)	2,00 (0,36 - 2,85)	2,39 (0,56 - 3,35)
Annual energy consumption ³⁾		kWh/a	1029	1341	1342	1549	2732
Indoor unit			S-3650PK3E	S-3650PK3E	S-6010PK3E	S-6010PK3E	S-6010PK3E
Air flow	Hi / Med / Lo	m ³ /min	13,0/11,0/9,0	16,0/13,5/11,0	20,0/17,5/14,5	20,0/17,5/14,5	22,0/18,5/15,0
Moisture removal volume		L/h	0,9	1,8	2,0	3,0	4,8
Sound pressure ⁴⁾	Hi / Med / Lo	dB(A)	35/31/27	40/36/32	47/44/40	47/44/40	49/45/41
Sound power	Hi / Med / Lo	dB(A)	51/47/43	56/52/48	63/60/56	63/60/56	65/61/57
Dimension	H x W x D	mm	302 x 1120 x 236	302 x 1120 x 236	302 x 1120 x 236	302 x 1120 x 236	302 x 1120 x 236
Net weight		kg	13	13	14	14	14
nanoe X Generator			Mark 2	Mark 2	Mark 2	Mark 2	Mark 2
Outdoor unit			U-36PZH3E5	U-50PZH3E5	U-60PZH3E5	U-71PZH3E5	U-100PZH3E5
Power source		V	220 - 230 - 240	220 - 230 - 240	220 - 230 - 240	220 - 230 - 240	220 - 230 - 240
Current	Cool	A	3,60 - 3,45 - 3,30	5,60 - 5,35 - 5,10	7,40 - 7,10 - 6,80	10,0 - 9,60 - 9,20	14,40 - 13,80 - 13,20
	Heat	A	4,05 - 3,90 - 3,70	6,40 - 6,10 - 5,85	7,75 - 7,40 - 7,10	9,65 - 9,35 - 8,95	11,70 - 11,30 - 10,80
Air flow	Cool / Heat	m ³ /min	34,1/36,4	42,0/42,0	42,0/42,0	61,0/60,0	118,0/108,0
Sound pressure	Cool / Heat (Hi)	dB(A)	43/44	46/48	47/50	48/50	52/52
Sound power	Cool / Heat (Hi)	dB(A)	62/64	64/67	65/69	65/67	69/69
Dimension	H x W x D	mm	695 x 875 x 320	695 x 875 x 320	695 x 875 x 320	996 x 940 x 340	1416 x 940 x 340
Net weight		kg	42	42	43	65	98
Pipe diameter	Liquid pipe	Inch (mm)	1/4 (6,35)	1/4 (6,35)	1/4 (6,35) ⁵⁾	3/8 (9,52)	3/8 (9,52)
	Gas pipe	Inch (mm)	1/2 (12,70)	1/2 (12,70)	1/2 (12,70) ⁶⁾	5/8 (15,88)	5/8 (15,88)
Pipe length range		m	3 - 40	3 - 40	3 - 40	5 - 50	5 - 85
Elevation difference (in/out) ⁷⁾		m	15/30 ⁸⁾	15/30 ⁸⁾	15/30 ⁸⁾	15/30 ⁸⁾	15/30 ⁸⁾
Pipe length for additional gas		m	30	30	30	30	30
Additional gas amount		g/m	15	15	15	45	45
Refrigerant (R32) / CO ₂ Eq.		kg / T	1,13/0,76	1,13/0,76	1,15/0,78	1,95/1,32	3,05/2,06
Operating range	Cool Min ~ Max	°C	-15 ~ +46	-15 ~ +46	-15 ~ +46	-15 ~ +48	-20 ~ +48 ⁹⁾
	Heat Min ~ Max	°C	-20 ~ +24	-20 ~ +24	-20 ~ +24	-20 ~ +24	-20 ~ +24

Technical focus

- Modern design with flat face and compact size
- DC fan for better efficiency and control
- Six directional piping outlet
- nanoe™ X (Generator Mark 2= 9,6 trillion hydroxyl radicals/sec) as standard for better indoor air quality
- Wired remote control CZ-RTC6BL allows easy system setting via Bluetooth®
- Easy connection and control of external fan or ERV using the connector PAW-FDC on the indoor unit PCB. The external device can be controlled by the remote control of the Panasonic indoor unit

Closed discharge port

When the unit is turned OFF, the flap closes completely to prevent dust getting into the unit and to keep the equipment clean.

Quiet operation

These units are among the quietest in the industry, making them ideal for hotels and hospitals.

Piping outlet in six directions

Piping outlet is possible in the six directions of right, right rear, right bottom, left, left rear and left bottom, making the installation work easier.



CZ-RTC5B

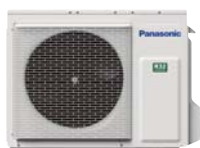

Optional controller.
CONEX wired remote controller.
CZ-RTC6 - CZ-RTC6BL
- CZ-RTC6BLW



Optional controller.
Infrared remote controller.
CZ-RWS3



Optional Econavi sensor.
CZ-CENSC1

COMPATIBLE WITH ALL PANASONIC CONNECTIVITY SOLUTIONS

Three phase

			7,1 kW	10,0 kW
Kit			KIT-71PK3ZH8	KIT-100PK3ZH8
Remote controller			CZ-RTC5B	CZ-RTC5B
Cooling capacity	Nominal (Min - Max)	kW	7,1 (2,2 - 9,0)	9,5 (3,1 - 10,5)
EER ¹⁾		W/W	3,50	3,26
SEER ²⁾			6,7 A++	6,3 A++
Pdesign		kW	7,1	9,5
Input power cooling		kW	2,03	2,91
Annual energy consumption ³⁾		kWh/a	370	526
Heating capacity	Nominal (Min - Max)	kW	8,0 (2,0 - 9,0)	9,5 (3,1 - 11,5)
COP ¹⁾		W/W	4,00	3,97
SCOP ²⁾			4,7 A++	4,1 A+
Pdesign at -10 °C		kW	5,2	8,0
Input power heating		kW	2,00	2,39
Annual energy consumption ³⁾		kWh/a	1549	2732
Indoor unit			S-6010PK3E	S-6010PK3E
Air flow	Hi / Med / Lo	m ³ /min	20,0/17,5/14,5	22,0/18,5/15,0
Moisture removal volume		L/h	3,0	4,8
Sound pressure ⁴⁾	Hi / Med / Lo	dB(A)	47/44/40	49/45/41
Sound power	Hi / Med / Lo	dB(A)	63/60/56	65/61/57
Dimension	HxWxD	mm	302x1120x236	302x1120x236
Net weight		kg	14	14
nanoe X Generator			Mark 2	Mark 2
Outdoor unit			U-71PZH3E8	U-100PZH3E8
Power source		V	380-400-415	380-400-415
Current	Cool	A	3,40-3,25-3,15	4,85-4,60-4,40
	Heat	A	3,30-3,15-3,05	4,00-3,80-3,60
Air flow	Cool / Heat	m ³ /min	61,0/60,0	118,0/108,0
Sound pressure	Cool / Heat (Hi)	dB(A)	48/50	52/52
Sound power	Cool / Heat (Hi)	dB(A)	65/67	69/69
Dimension	HxWxD	mm	996x940x340	1416x940x340
Net weight		kg	65	98
Pipe diameter	Liquid pipe	Inch (mm)	3/8(9,52)	3/8(9,52)
	Gas pipe	Inch (mm)	5/8(15,88)	5/8(15,88)
Pipe length range		m	5-50	5-85
Elevation difference (in/out) ⁷⁾		m	15/30 ⁸⁾	15/30 ⁸⁾
Pipe length for additional gas		m	30	30
Additional gas amount		g/m	45	45
Refrigerant (R32) / CO ₂ Eq.		kg / T	1,95/1,32	3,05/2,06
Operating range	Cool Min ~ Max	°C	-15 ~ +48	-20 ~ +48 ⁹⁾
	Heat Min ~ Max	°C	-20 ~ +24	-20 ~ +24

Accessories

CZ-RTC6	CONEX wired remote controller (non-wireless)
CZ-RTC6BL	CONEX wired remote controller with Bluetooth®
CZ-RTC6BLW	CONEX wired remote controller with Wi-Fi and Bluetooth®
CZ-RTC5B	Wired remote controller with Econavi function and datanavi
CZ-RWS3	Infrared remote controller
CZ-CAPWFC1	Commercial Wi-Fi Adaptor

Accessories

PAW-PACR3	Interfaces to run 3 units on Backup and alternative run
PAW-WTRAY	Tray for condenser water compatible with outdoor elevation platform
PAW-GRDBSE20	Outdoor base ground support for noise and vibration absorption
PAW-GRDSTD40	Outdoor elevation platform 400x900x400 mm
CZ-CENSC1	Econavi energy savings sensor

1) EER and COP calculation is based in accordance to EN14511. 2) For models below 12 kW, the SEER and SCOP is calculated based on values of EU/626/2011. For models above 12 kW, the η_{sc} / η_{sh} values is calculated based on EN 14825. 3) Factory setting. 4) The sound pressure of the units shows the value measured of the position 1 m in front of the main body and 1 m below the unit. The sound pressure is measured in accordance with Eurovent 6/C/006-97 specification. 5) Connect the liquid socket tube (Ø6,35-Ø9,52) to the liquid tubing side indoor unit. 6) Connect the gas socket tube (Ø12,70-Ø15,88) to the gas tubing side indoor unit. 7) When installing the outdoor unit at a higher position than the indoor unit. 8) Outdoor unit located lower / outdoor unit located higher. 9) For models 100 ~ 140PZH3E5(8), it is possible to operate the lowest -20 °C in the computer rooms with the piping length of 30 m or less. * Recommended fuse for the indoor 3 A. ** Above values are in the case of nanoe™ X OFF.



SEER and SCOP: For S-3650PK3E + U-36PZH3E5. INTERNET CONTROL: Optional.

Rating Conditions: Cooling Indoor 27 °C DB / 19 °C WB. Cooling Outdoor 35 °C DB / 24 °C WB. Heating Indoor 20 °C DB. Heating Outdoor 7 °C DB / 6 °C WB. (DB: Dry Bulb; WB: Wet Bulb). Specifications subject to change without notice. For detailed information about ErP / Energy Labelling, please visit our websites www.aircon.panasonic.eu or www.ptc.panasonic.eu.

NEW
2021

nanoe™ X as a standard.

NEW PACi NX Series Standard wall-mounted Inverter+
• R32

The wall-mounted units with stylish matt color can be offered for many applications such as studios, gyms, high ceiling areas and even computer server rooms.

The compact design and flat face ensure discreet installation, even in a small space.



		Single phase					
		3,6 kW	5,0 kW	6,0 kW	7,1 kW	10,0 kW	
Kit		KIT-36PK3Z5	KIT-50PK3Z5	KIT-60PK3Z5	KIT-71PK3Z5	KIT-100PK3Z5	
Remote controller		CZ-RTC5B	CZ-RTC5B	CZ-RTC5B	CZ-RTC5B	CZ-RTC5B	
Cooling capacity	Nominal (Min - Max)	kW	3,6(1,5 - 4,0)	5,0(1,5 - 5,6)	6,1(2,0 - 7,1)	7,1(2,6 - 7,7)	9,0(3,0 - 9,7)
EER ¹⁾		W/W	4,14	3,52	3,67	3,16	3,47
SEER ²⁾			7,6 A++	7,4 A++	7,0 A++	5,8 A+	6,5 A++
Pdesign		kW	3,6	5,0	6,1	7,1	9,0
Input power cooling		kW	0,87	1,42	1,66	2,25	2,59
Annual energy consumption ³⁾		kWh/a	166	237	3,05	429	485
Heating capacity	Nominal (Min - Max)	kW	3,6(1,5 - 4,6)	5,0(1,5 - 6,4)	6,1(1,8 - 7,0)	7,1(2,1 - 8,1)	9,0(3,0 - 10,5)
COP ¹⁾		W/W	4,62	4,20	4,39	4,23	3,93
SCOP ²⁾			4,5 A+	4,4 A+	4,7 A++	4,4 A+	3,9 A
Pdesign at -10 °C		kW	2,8	4,0	4,6	5,2	9,0
Input power heating		kW	0,78	1,19	1,39	1,68	2,29
Annual energy consumption ³⁾		kWh/a	872	1273	1370	1653	3231
Indoor unit			S-3650PK3E	S-3650PK3E	S-6010PK3E	S-6010PK3E	S-6010PK3E
Air flow	Hi / Med / Lo	m ³ /min	13,0/11,0/9,0	16,0/13,5/11,0	20,0/17,5/14,5	20,0/17,5/14,5	22,0/18,5/15,0
Moisture removal volume		L/h	0,9	1,8	2,0	3,0	4,3
Sound pressure ⁴⁾	Hi / Med / Lo	dB(A)	35/31/27	40/36/32	47/44/40	47/44/40	49/45/41
Sound power	Hi / Med / Lo	dB(A)	51/47/43	56/52/48	63/60/56	63/60/56	65/61/57
Dimension	H x W x D	mm	302 x 1120 x 236	302 x 1120 x 236	302 x 1120 x 236	302 x 1120 x 236	302 x 1120 x 236
Net weight		kg	13	13	14	14	14
nanoe X Generator			Mark 2	Mark 2	Mark 2	Mark 2	Mark 2
Outdoor unit			U-36PZ3E5	U-50PZ3E5	U-60PZ3E5A	U-71PZ3E5A	U-100PZ3E5
Power source		V	220 - 230 - 240	220 - 230 - 240	220 - 230 - 240	220 - 230 - 240	220 - 230 - 240
Current	Cool	A	4,05 - 3,85 - 3,70	6,60 - 6,30 - 6,05	7,70 - 7,35 - 7,05	10,4 - 10,00 - 9,55	12,9 - 12,4 - 11,9
	Heat	A	3,65 - 3,50 - 3,35	5,60 - 5,35 - 5,10	6,45 - 6,15 - 5,90	7,80 - 7,45 - 7,15	11,4 - 10,9 - 10,5
Air flow	Cool / Heat	m ³ /min	33,6/34,0	32,7/31,9	42,6/41,5	44,7/45,9	73,0/73,0
Sound pressure	Cool / Heat (Hi)	dB(A)	46/47	46/46	47/48	48/49	52/52
Sound power	Cool / Heat (Hi)	dB(A)	64/66	64/64	64/65	66/68	70/70
Dimension	H x W x D	mm	619 x 824 x 299	619 x 824 x 299	695 x 875 x 320	695 x 875 x 320	996 x 980 x 370
Net weight		kg	32	35	42	50	83
Pipe diameter	Liquid pipe	Inch (mm)	1/4(6,35)	1/4(6,35)	1/4(6,35) ⁵⁾	1/4(6,35) ⁵⁾	3/8(9,52)
	Gas pipe	Inch (mm)	1/2(12,70)	1/2(12,70)	1/2(12,70) ⁶⁾	5/8(15,88) ⁶⁾	5/8(15,88)
Pipe length range		m	3 - 15	3 - 20	3 - 40	3 - 40	3 - 50
Elevation difference (in/out) ⁷⁾		m	15/15 ⁸⁾	15/15 ⁸⁾	15/30 ⁸⁾	20/30 ⁸⁾	15/30 ⁸⁾
Pipe length for additional gas		m	7,5	7,5	30	30	30
Additional gas amount		g/m	10	15	15	17	45
Refrigerant (R32) / CO ₂ Eq.		kg / T	0,87/0,59	1,14/0,77	1,15/0,78	1,32/0,89	2,4/1,62
Operating range	Cool Min ~ Max	°C	-10 ~ +43	-10 ~ +43	-10 ~ +43	-10 ~ +43	-10 ~ +43
	Heat Min ~ Max	°C	-15 ~ +24	-15 ~ +24	-15 ~ +24	-15 ~ +24	-15 ~ +24

Technical focus

- Modern design with flat face and compact size
- DC fan for better efficiency and control
- Six directional piping outlet
- nanoe™ X (Generator Mark 2= 9,6 trillion hydroxyl radicals/sec) as standard for better indoor air quality
- Wired remote control CZ-RTC6BL allows easy system setting via Bluetooth®
- Easy connection and control of external fan or ERV using the connector PAW-FDC on the indoor unit PCB. The external device can be controlled by the remote control of the Panasonic indoor unit

Closed discharge port

When the unit is turned OFF, the flap closes completely to prevent dust getting into the unit and to keep the equipment clean.

Quiet operation

These units are among the quietest in the industry, making them ideal for hotels and hospitals.

Piping outlet in six directions

Piping outlet is possible in the six directions of right, right rear, right bottom, left, left rear and left bottom, making the installation work easier.



CZ-RTC5B



CONEX



Optional controller.
CONEX wired remote
controller.
CZ-RTC6 - CZ-RTC6BL
- CZ-RTC6BLW



Optional controller.
Infrared remote
controller.
CZ-RWS3



Optional Econavi
sensor.
CZ-CENSC1

COMPATIBLE WITH ALL PANASONIC
CONNECTIVITY SOLUTIONS

			Three phase
			10,0 kW
			KIT-100PK3Z8
			CZ-RTC5B
Kit			
Remote controller			
Cooling capacity	Nominal (Min - Max)	kW	9,0 (3,0 - 9,7)
EER ¹⁾		W/W	3,47
SEER ²⁾			6,5 A++
Pdesign		kW	9,0
Input power cooling		kW	2,59
Annual energy consumption ³⁾		kWh/a	485
Heating capacity	Nominal (Min - Max)	kW	9,0 (3,0 - 10,5)
COP ¹⁾		W/W	3,93
SCOP ²⁾			3,9 A
Pdesign at -10 °C		kW	9,0
Input power heating		kW	2,29
Annual energy consumption ³⁾		kWh/a	3231
Indoor unit			S-6010PK3E
Air flow	Hi / Med / Lo	m ³ /min	22,0 / 18,5 / 15,0
Moisture removal volume		L/h	4,3
Sound pressure ⁴⁾	Hi / Med / Lo	dB(A)	49 / 45 / 41
Sound power	Hi / Med / Lo	dB(A)	65 / 61 / 57
Dimension	HxWxD	mm	302 x 1120 x 236
Net weight		kg	14
nanoe X Generator			Mark 2
Outdoor unit			U-100PZ3E8
Power source		V	380 - 400 - 415
Current	Cool	A	4,30 - 4,10 - 3,95
	Heat	A	3,80 - 3,65 - 3,50
Air flow	Cool / Heat	m ³ /min	73,0 / 73,0
Sound pressure	Cool / Heat (Hi)	dB(A)	52 / 52
Sound power	Cool / Heat (Hi)	dB(A)	70 / 70
Dimension	HxWxD	mm	996 x 980 x 370
Net weight		kg	83
Pipe diameter	Liquid pipe	Inch (mm)	3/8 (9,52)
	Gas pipe	Inch (mm)	5/8 (15,88)
Pipe length range		m	5 - 50
Elevation difference (in/out) ⁷⁾		m	15 / 30 ⁸⁾
Pipe length for additional gas		m	30
Additional gas amount		g/m	45
Refrigerant (R32) / CO ₂ Eq.		kg / T	2,4 / 1,62
Operating range	Cool Min ~ Max	°C	-10 ~ +43
	Heat Min ~ Max	°C	-15 ~ +24

Accessories

CZ-RTC6	CONEX wired remote controller (non-wireless)
CZ-RTC6BL	CONEX wired remote controller with Bluetooth®
CZ-RTC6BLW	CONEX wired remote controller with Wi-Fi and Bluetooth®
CZ-RTC5B	Wired remote controller with Econavi function and datanavi
CZ-RWS3	Infrared remote controller
CZ-CAPWFC1	Commercial Wi-Fi Adaptor

Accessories

PAW-PACR3	Interfaces to run 3 units on Backup and alternative run
PAW-WTRAY	Tray for condenser water compatible with outdoor elevation platform
PAW-GRDBSE20	Outdoor base ground support for noise and vibration absorption
PAW-GRDSTD40	Outdoor elevation platform 400x900x400 mm
CZ-CENSC1	Econavi energy savings sensor

1) EER and COP calculation is based in accordance to EN14511. 2) For models below 12 kW, the SEER and SCOP is calculated based on values of EU/626/2011. For models above 12 kW, the η_{sc} / η_{sh} values is calculated based on EN 14825. 3) Factory setting. 4) The sound pressure of the units shows the value measured of the position 1 m in front of the main body and 1 m below the unit. The sound pressure is measured in accordance with Eurovent 6/C/006-97 specification. 5) Connect the liquid socket tube (Ø6,35-Ø9,52) to the liquid tubing side indoor unit. 6) Connect the gas socket tube (Ø12,70-Ø15,88) to the gas tubing side indoor unit. 7) When installing the outdoor unit at a higher position than the indoor unit. 8) Outdoor unit located lower / outdoor unit located higher. * Recommended fuse for the indoor 3 A. ** Above values are in the case of nanoe™ X OFF.



SEER: For S-3650PK3E + U-36PZ3E5. SCOP: For S-6010PK3E + U-60PZ3E5A. INTERNET CONTROL: Optional.

Rating Conditions: Cooling Indoor 27 °C DB / 19 °C WB. Cooling Outdoor 35 °C DB / 24 °C WB. Heating Indoor 20 °C DB. Heating Outdoor 7 °C DB / 6 °C WB. (DB: Dry Bulb; WB: Wet Bulb). Specifications subject to change without notice. For detailed information about ErP / Energy Labelling, please visit our websites www.aircon.panasonic.eu or www.ptc.panasonic.eu.

NEW
2021

nanoeX™
nanoe™ X as a standard.

NEW PACi NX Series Elite and Standard 4 way 60x60 cassette Inverter+ • R32

New 4 way 60x60 cassette - PY3.

- From 2,5 to 6,0 kW (4 capacity sizes)
- Chassis dimensions (H x W x D): 230 x 575 x 575 mm
- SEER/SCOP class A++*
- Built-in drain pump

* SCOP class A+ in case of 2,5 / 6,0 kW.

Elite			Single phase		
			3,6 kW	5,0 kW	6,0 kW
Kit					
Remote controller			CZ-RTC5B	CZ-RTC5B	CZ-RTC5B
Cooling capacity	Nominal (Min - Max)	kW	3,6(1,2 - 4,0)	5,0(1,2 - 5,6)	6,0(1,2 - 6,5)
EER ¹⁾		W/W	4,50	3,76	3,43
SEER ²⁾			6,8 A++	6,7 A++	6,7 A++
Pdesign		kW	3,6	5,0	6,0
Input power cooling		kW	0,80	1,33	1,75
Annual energy consumption ³⁾		kWh/a			
Heating capacity	Nominal (Min - Max)	kW	4,0(1,2 - 5,0)	5,6(1,2 - 6,5)	7,0(1,2 - 7,5)
COP ¹⁾		W/W	4,12	3,37	3,35
SCOP ²⁾			4,7 A++	4,6 A++	4,3 A+
Pdesign at -10 °C		kW	3,6	4,5	4,6
Input power heating		kW	0,97	1,66	2,09
Annual energy consumption ³⁾		kWh/a			
Indoor unit			S-36PY3E	S-50PY3E	S-60PY3E
Air flow	Hi / Med / Lo	m ³ /min	9,5/8,0/6,0	12,0/9,5/6,5	14,0/10,5/8,0
Moisture removal volume		L/h	1,5	2,3	2,8
Sound pressure ⁴⁾	Hi / Med / Lo	dB(A)	34/30/25	39/34/27	43/37/31
Sound power	Hi / Med / Lo	dB(A)	49/45/40	54/49/42	58/52/46
Dimension	Indoor (HxWxD)	mm			
	Panel (HxWxD)	mm			
Net weight	Indoor / Panel	kg			
nanoe X Generator					
Outdoor unit			U-36PZH3E5	U-50PZH3E5	U-60PZH3E5
Power source		V	220 - 230 - 240	220 - 230 - 240	220 - 230 - 240
Current	Cool	A	3,25 - 3,10 - 3,00	5,50 - 5,25 - 5,05	6,95 - 6,65 - 6,35
	Heat	A	3,60 - 3,45 - 3,30	6,25 - 6,00 - 5,75	8,05 - 7,70 - 7,40
Air flow	Cool / Heat	m ³ /min	34,1/36,4	42,0/42,0	42,0/42,0
Sound pressure	Cool / Heat (Hi)	dB(A)	43/44	46/48	47/50
Sound power	Cool / Heat (Hi)	dB(A)	62/64	64/67	65/69
Dimension	HxWxD	mm	695x875x320	695x875x320	695x875x320
Net weight		kg	42	42	43
Pipe diameter	Liquid pipe	Inch (mm)	1/4 (6,35)	1/4 (6,35)	1/4 (6,35) ⁵⁾
	Gas pipe	Inch (mm)	1/2 (12,70)	1/2 (12,70)	1/2 (12,70) ⁶⁾
Pipe length range		m	3 - 40	3 - 40	3 - 40
Elevation difference (in/out) ⁷⁾		m	15/30 ⁸⁾	15/30 ⁸⁾	15/30 ⁸⁾
Pipe length for additional gas		m	30	30	30
Additional gas amount		g/m	15	15	15
Refrigerant (R32) / CO ₂ Eq.		kg / T	1,13/0,76	1,13/0,76	1,15/0,78
Operating range	Cool Min ~ Max	°C	-15 ~ +46	-15 ~ +46	-15 ~ +46
	Heat Min ~ Max	°C	-20 ~ +24	-20 ~ +24	-20 ~ +24

Tentative data

Compact and stylish design

- Ceiling depth is only 243 mm
- Exposed area is only 30 mm

Industry-leading energy efficiency

Achieved SEER/SCOP class A++*.

* SCOP class A+ in case of 2,5 / 6,0 kW.

Individual flap control

Better control of the air flow with 2 flap motors.

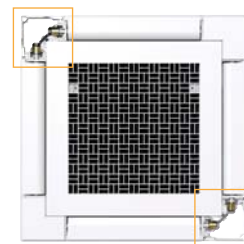

SEER and SCOP: For S-36PY3E + U-36PZH3E5. ECONAVI and INTERNET CONTROL: Optional.



Panel.
CZ-KPY4

CZ-RTC5B

COMPATIBLE WITH ALL PANASONIC
CONNECTIVITY SOLUTIONS



CONEX



Optional controller.
CONEX wired remote
controller.
CZ-RTC6 - CZ-RTC6BL
- CZ-RTC6BLW



Optional controller.
Infrared remote
controller.
CZ-RWS3 +
CZ-RWRY3



Optional Econavi
sensor.
CZ-CENSC1

Standard			Single phase			
			2,5 kW	3,6 kW	5,0 kW	6,0 kW
Kit						
Remote controller			CZ-RTC5B	CZ-RTC5B	CZ-RTC5B	CZ-RTC5B
Cooling capacity	Nominal (Min - Max)	kW	2,5(1,5 - 3,9)	3,6(1,5 - 4,0)	5,0(1,5 - 5,6)	6,0(2,0 - 7,0)
EER ¹⁾		W/W	4,46	3,96	3,50	3,39
SEER ²⁾			6,3 A++	6,7 A++	6,6 A++	6,6 A++
Pdesign		kW	2,5	3,6	5,0	6,0
Input power cooling		kW	0,56	0,91	1,43	1,77
Annual energy consumption ³⁾		kWh/a				
Heating capacity	Nominal (Min - Max)	kW	3,2(1,5 - 4,6)	3,6(1,5 - 4,6)	5,0(1,5 - 6,4)	6,0(1,8 - 7,0)
COP ¹⁾		W/W	4,44	4,29	3,94	3,61
SCOP ²⁾			4,4 A+	4,3 A+	4,2 A+	4,1 A+
Pdesign at -10 °C		kW	2,5	2,8	4,0	4,6
Input power heating		kW	0,72	0,84	1,27	1,66
Annual energy consumption ³⁾		kWh/a				
Indoor unit			S-25PY3E	S-36PY3E	S-50PY3E	S-60PY3E
Air flow	Hi / Med / Lo	m ³ /min	8,5/7,0/6,0	9,5/8,0/6,0	12,0/9,5/6,5	14,0/10,5/8,0
Moisture removal volume		L/h	0,7	1,5	2,3	2,8
Sound pressure ⁴⁾	Hi / Med / Lo	dB(A)	31/28/25	34/30/25	39/34/27	43/37/31
Sound power	Hi / Med / Lo	dB(A)	46/43/40	49/45/40	54/49/42	58/52/46
Dimension	Indoor (HxWxD)	mm				
	Panel (HxWxD)	mm				
Net weight	Indoor / Panel	kg				
nanoe X Generator						
Outdoor unit			U-25PZ3E5	U-36PZ3E5	U-50PZ3E5	U-60PZ3E5A
Power source		V	220 - 230 - 240	220 - 230 - 240	220 - 230 - 240	220 - 230 - 240
Current	Cool	A		4,05 - 3,85 - 3,70	6,60 - 6,30 - 6,05	7,70 - 7,35 - 7,05
	Heat	A		3,65 - 3,50 - 3,35	5,60 - 5,35 - 5,10	6,45 - 6,15 - 5,90
Air flow	Cool / Heat	m ³ /min		33,6/34,0	32,7/31,9	42,6/41,5
Sound pressure	Cool / Heat (Hi)	dB(A)		46/47	46/46	47/48
Sound power	Cool / Heat (Hi)	dB(A)		64/66	64/64	64/65
Dimension	HxWxD	mm		619x824x299	619x824x299	695x875x320
Net weight		kg		32	35	42
Pipe diameter	Liquid pipe	Inch (mm)		1/4(6,35)	1/4(6,35)	1/4(6,35) ⁵⁾
	Gas pipe	Inch (mm)		1/2(12,70)	1/2(12,70)	1/2(12,70) ⁶⁾
Pipe length range		m		3 - 15	3 - 20	3 - 40
Elevation difference (in/out) ⁷⁾		m		15/15 ⁸⁾	15/15 ⁸⁾	15/30 ⁸⁾
Pipe length for additional gas		m		7,5	7,5	7,5
Additional gas amount		g/m		10	15	15
Refrigerant [R32] / CO ₂ Eq.		kg / T		0,87/0,59	1,14/0,77	1,15/0,78
Operating range	Cool Min ~ Max	°C	-10 ~ +43	-10 ~ +43	-10 ~ +43	-10 ~ +43
	Heat Min ~ Max	°C	-15 ~ +24	-15 ~ +24	-15 ~ +24	-15 ~ +24

Tentative data

Accessories

CZ-RTC6	CONEX wired remote controller (non-wireless)
CZ-RTC6BL	CONEX wired remote controller with Bluetooth®
CZ-RTC6BLW	CONEX wired remote controller with Wi-Fi and Bluetooth®
CZ-RTC5B	Wired remote controller with Econavi function and datanavi
CZ-RWS3 + CZ-RWRY3	Infrared remote controller

Accessories

CZ-CAPWFC1	Commercial Wi-Fi Adaptor
PAW-WTRAY	Tray for condenser water compatible with outdoor elevation platform
PAW-GRDBSE20	Outdoor base ground support for noise and vibration absorption
PAW-GRDSTD40	Outdoor elevation platform 400x900x400 mm
CZ-CENSC1	Econavi energy savings sensor

1) EER and COP calculation is based in accordance to EN14511. 2) For models below 12 kW, the SEER and SCOP is calculated based on values of EU/626/2011. For models above 12 kW, the η_{sc} / η_{sh} values is calculated based on EN 14825. 3) Factory setting. 4) The sound pressure of the units shows the value measured of the position 1,5 m below the unit. The sound pressure is measured in accordance with Eurovent 6/C/006-97 specification. 5) Connect the liquid socket tube (Ø6,35-Ø9,52) to the liquid tubing side indoor unit. 6) Connect the gas socket tube (Ø12,70-Ø15,88) to the gas tubing side indoor unit. 7) When installing the outdoor unit at a higher position than the indoor unit. 8) Outdoor unit located lower / outdoor unit located higher. 9) For models 100 ~ 140PZH3E5(8), it is possible to operate the lowest -20 °C in the computer rooms with the piping length of 30 m or less.* Recommended fuse for the indoor 3 A. ** Above values are in the case of nanoe™ X OFF. *** Available in Autumn 2021.



SEER: For S-36PY3E + U-36PZ3E5. SCOP: For S-25PY3E + U-25PZ3E5. ECONAVI and INTERNET CONTROL: Optional.

Rating Conditions: Cooling Indoor 27 °C DB / 19 °C WB. Cooling Outdoor 35 °C DB / 24 °C WB. Heating Indoor 20 °C DB. Heating Outdoor 7 °C DB / 6 °C WB. (DB: Dry Bulb; WB: Wet Bulb). Specifications subject to change without notice. For detailed information about ErP / Energy Labelling, please visit our websites www.aircon.panasonic.eu or www.ptc.panasonic.eu.

NEW
2021

nanoe™ X as a standard.

**NEW PACi NX Series Elite 4 way 90x90 cassette Inverter+
• R32**
New 4 way 90x90 cassette - PU3.

Powerful turbo fan and intelligent Econavi sensor ensure high energy efficiency, and nanoe™ X which is equipped as standard provides an exceptional level of indoor air quality.

		Single phase							
			3,6 kW	5,0 kW	6,0 kW	7,1 kW	10,0 kW	12,5 kW	14,0 kW
Kit			KIT-36PU3ZH5	KIT-50PU3ZH5	KIT-60PU3ZH5	KIT-71PU3ZH5	KIT-100PU3ZH5	KIT-125PU3ZH5	KIT-140PU3ZH5
Remote controller			CZ-RTC5B	CZ-RTC5B	CZ-RTC5B	CZ-RTC5B	CZ-RTC5B	CZ-RTC5B	CZ-RTC5B
Cooling capacity	Nominal (Min - Max)	kW	3,6(1,2 - 4,0)	5,0(1,2 - 5,6)	6,0(1,2 - 7,1)	7,1(2,2 - 9,0)	10,0(3,1 - 12,5)	12,5(3,2 - 14,0)	14,0(3,3 - 16,0)
EER ¹⁾		W/W	5,45	4,31	4,05	4,06	4,41	3,80	3,41
SEER / η _{sc} ²⁾			8,9 A+++	8,6 A+++	8,0 A++	7,7 A++	7,8 A++	304,3 %	286,6 %
Pdesign		kW	3,6	5,0	6,0	7,1	10,0	12,5	14,0
Input power cooling		kW	0,66	1,16	1,48	1,75	2,27	3,29	4,11
Annual energy consumption ³⁾		kWh/a	142	203	263	323	449	—	—
Heating capacity	Nominal (Min - Max)	kW	4,0(1,2 - 5,0)	5,6(1,2 - 6,5)	7,0(1,2 - 8,0)	8,0(2,0 - 9,0)	11,2(3,1 - 14,0)	14,0(3,2 - 16,0)	16,0(3,3 - 18,0)
COP ¹⁾		W/W	5,41	4,24	4,02	4,30	5,00	4,61	4,30
SCOP / η _{sc} ²⁾			5,1 A+++	4,9 A++	4,8 A++	4,8 A++	4,9 A++	186,0 %	181,2 %
Pdesign at -10 °C		kW	3,6	4,5	4,7	5,2	8,0	9,5	10,6
Input power heating		kW	0,74	1,32	1,74	1,86	2,24	3,04	3,72
Annual energy consumption ³⁾		kWh/a	988	1286	1371	1517	2286	—	—
Indoor unit			S-3650PU3E	S-3650PU3E	S-6071PU3E	S-6071PU3E	S-1014PU3E	S-1014PU3E	S-1014PU3E
Air flow	Hi / Med / Lo	m ³ /min	14,5/13,0/11,5	16,5/13,5/11,5	21,0/16,0/13,0	22,0/16,0/13,0	36,0/26,0/18,0	37,0/27,0/19,0	38,0/29,0/20,0
Moisture removal volume		L/h	0,7	1,6	1,7	2,5	2,7	4,8	6,0
Sound pressure ⁴⁾	Hi / Med / Lo	dB(A)	30/28/27	32/29/27	36/31/28	37/31/28	45/38/32	46/39/33	47/40/34
Sound power	Hi / Med / Lo	dB(A)	45/43/42	47/44/42	51/46/43	52/46/43	60/53/47	61/54/48	62/55/49
Dimension	Indoor (HxWxD)	mm	256x840x840	256x840x840	256x840x840	256x840x840	319x840x840	319x840x840	319x840x840
	Panel (HxWxD)	mm	33,5x950x950	33,5x950x950	33,5x950x950	33,5x950x950	33,5x950x950	33,5x950x950	33,5x950x950
Net weight	Indoor / Panel	kg	19/5	19/5	20/5	20/5	25/5	25/5	25/5
nanoe X Generator			Mark 1	Mark 1	Mark 1	Mark 1	Mark 1	Mark 1	Mark 1
Outdoor unit			U-36PZH3E5	U-50PZH3E5	U-60PZH3E5	U-71PZH3E5	U-100PZH3E5	U-125PZH3E5	U-140PZH3E5
Power source		V	220 - 230 - 240	220 - 230 - 240	220 - 230 - 240	220 - 230 - 240	220 - 230 - 240	220 - 230 - 240	220 - 230 - 240
Current	Cool	A	3,25 - 3,10 - 3,00	5,50 - 5,25 - 5,05	6,95 - 6,65 - 6,35	8,65 - 8,25 - 7,95	11,20 - 10,70 - 10,30	16,10 - 15,40 - 14,70	20,10 - 19,20 - 18,40
	Heat	A	3,60 - 3,45 - 3,30	6,25 - 6,00 - 5,75	8,05 - 7,70 - 7,40	9,00 - 8,70 - 8,35	10,90 - 10,60 - 10,10	14,90 - 14,20 - 13,60	18,20 - 17,40 - 16,70
Air flow	Cool / Heat	m ³ /min	34,1/36,4	42,0/42,0	42,0/42,0	61,0/60,0	118,0/108,0	125,0/112,0	129,0/116,0
Sound pressure	Cool / Heat (Hi)	dB(A)	43/44	46/48	47/50	48/50	52/52	53/53	54/54
Sound power	Cool / Heat (Hi)	dB(A)	62/64	64/67	65/69	65/67	69/69	70/70	71/71
Dimension	HxWxD	mm	695x875x320	695x875x320	695x875x320	996x940x340	1416x940x340	1416x940x340	1416x940x340
Net weight		kg	42	42	43	65	98	98	98
Pipe diameter	Liquid pipe	Inch (mm)	1/4 (6,35)	1/4 (6,35)	1/4 (6,35) ⁵⁾	3/8 (9,52)	3/8 (9,52)	3/8 (9,52)	3/8 (9,52)
	Gas pipe	Inch (mm)	1/2 (12,70)	1/2 (12,70)	1/2 (12,70) ⁶⁾	5/8 (15,88)	5/8 (15,88)	5/8 (15,88)	5/8 (15,88)
Pipe length range		m	3~40	3~40	3~40	5~50	5~85	5~85	5~85
Elevation difference (in/out) ⁷⁾		m	15/30 ⁸⁾	15/30 ⁸⁾	15/30 ⁸⁾	15/30 ⁸⁾	15/30 ⁸⁾	15/30 ⁸⁾	15/30 ⁸⁾
Pipe length for additional gas		m	30	30	30	30	30	30	30
Additional gas amount		g/m	15	15	15	45	45	45	45
Refrigerant (R32) / CO ₂ , Eq.		kg / T	1,13/0,76	1,13/0,76	1,15/0,78	1,95/1,32	3,05/2,06	3,05/2,06	3,05/2,06
Operating range	Cool Min - Max	°C	-15~+46	-15~+46	-15~+46	-15~+48	-20~+48 ⁹⁾	-20~+48 ⁹⁾	-20~+48 ⁹⁾
	Heat Min - Max	°C	-20~+24	-20~+24	-20~+24	-20~+24	-20~+24	-20~+24	-20~+24

Technical focus

- High performance turbo fan, path system for heat exchanger
- Econavi: An optional intelligent sensor to reduce waste of energy
- nanoe™ X (Generator Mark 1= 4,8 trillion hydroxyl radicals/sec) as standard for better indoor air quality, indoor unit internal cleaning with nanoe™ X and dry operation
- Lower noise in slow fan operation
- Light weight, easy piping and integrated drain pump for quick installation
- Wired remote control CZ-RTC6BL allows easy system setting via Bluetooth®
- High volume fresh air input with optional air-intake plenum and chamber (CZ-FDU3+CZ-ATU2)

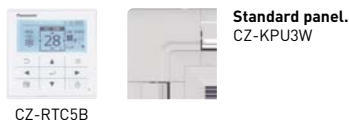

Standard panel.
CZ-KPU3W

COMPATIBLE WITH ALL PANASONIC
CONNECTIVITY SOLUTIONS



Optional
Econavi panel
(CZ-RTC5B is
required).
CZ-KPU3AW



Optional controller.
CONEX wired remote
controller.
CZ-RTC6 - CZ-RTC6BL
- CZ-RTC6BLW



Optional controller.
Infrared remote
controller.
CZ-RWS3 +
CZ-RWRU3W

Three phase

			7,1 kW	10,0 kW	12,5 kW	14,0 kW
Kit			KIT-71PU3ZH8	KIT-100PU3ZH8	KIT-125PU3ZH8	KIT-140PU3ZH8
Remote controller			CZ-RTC5B	CZ-RTC5B	CZ-RTC5B	CZ-RTC5B
Cooling capacity	Nominal (Min - Max)	kW	7,1 [2,2 - 9,0]	10,0 [3,1 - 12,5]	12,5 [3,2 - 14,0]	14,0 [3,3 - 16,0]
EER ¹⁾		W/W	4,06	4,41	3,80	3,41
SEER / η _{sc} ²⁾			7,6 A++	7,7 A++	303,3 %	285,6 %
P _{design}		kW	7,1	10,0	12,5	14,0
Input power cooling		kW	1,75	2,27	3,29	4,11
Annual energy consumption ³⁾		kWh/a	327	455	—	—
Heating capacity	Nominal (Min - Max)	kW	8,0 [2,0 - 9,0]	11,2 [3,1 - 14,0]	14,0 [3,2 - 16,0]	16,0 [3,3 - 18,0]
COP ¹⁾		W/W	4,30	5,00	4,61	4,30
SCOP / η _{sc} ²⁾			4,8 A++	4,9 A++	186,0 %	181,1 %
P _{design} at -10 °C		kW	5,2	8,0	9,5	10,6
Input power heating		kW	1,86	2,24	3,04	3,72
Annual energy consumption ³⁾		kWh/a	1517	2286	—	—
Indoor unit			S-6071PU3E	S-1014PU3E	S-1014PU3E	S-1014PU3E
Air flow	Hi / Med / Lo	m ³ /min	22,0/16,0/13,0	36,0/26,0/18,0	37,0/27,0/19,0	38,0/29,0/20,0
Moisture removal volume		L/h	2,5	2,7	4,8	6,0
Sound pressure ⁴⁾	Hi / Med / Lo	dB(A)	37/31/28	45/38/32	46/39/33	47/40/34
Sound power	Hi / Med / Lo	dB(A)	52/46/43	60/53/47	61/54/48	62/55/49
Dimension	Indoor (H x W x D)	mm	256 x 840 x 840	319 x 840 x 840	319 x 840 x 840	319 x 840 x 840
	Panel (H x W x D)	mm	33,5 x 950 x 950	33,5 x 950 x 950	33,5 x 950 x 950	33,5 x 950 x 950
Net weight	Indoor / Panel	kg	20/5	25/5	25/5	25/5
nanoe X Generator			Mark 1	Mark 1	Mark 1	Mark 1
Outdoor unit			U-71PZH3E8	U-100PZH3E8	U-125PZH3E8	U-140PZH3E8
Power source		V	380 - 400 - 415	380 - 400 - 415	380 - 400 - 415	380 - 400 - 415
Current	Cool	A	2,90 - 2,80 - 2,70	3,80 - 3,60 - 3,45	5,45 - 5,15 - 5,00	6,80 - 6,45 - 6,20
	Heat	A	3,05 - 2,95 - 2,85	3,75 - 3,55 - 3,40	5,10 - 4,80 - 4,65	6,20 - 5,90 - 5,65
Air flow	Cool / Heat	m ³ /min	61,0/60,0	118,0/108,0	125,0/112,0	129,0/116,0
Sound pressure	Cool / Heat (Hi)	dB(A)	48/50	52/52	53/53	54/54
Sound power	Cool / Heat (Hi)	dB(A)	65/67	69/69	70/70	71/71
Dimension	H x W x D	mm	996 x 940 x 340	1416 x 940 x 340	1416 x 940 x 340	1416 x 940 x 340
Net weight		kg	65	98	98	98
Pipe diameter	Liquid pipe	Inch (mm)	3/8 (9,52)	3/8 (9,52)	3/8 (9,52)	3/8 (9,52)
	Gas pipe	Inch (mm)	5/8 (15,88)	5/8 (15,88)	5/8 (15,88)	5/8 (15,88)
Pipe length range		m	5 - 50	5 - 85	5 - 85	5 - 85
Elevation difference (in/out) ⁷⁾		m	15/30 ⁸⁾	15/30 ⁸⁾	15/30 ⁸⁾	15/30 ⁸⁾
Pipe length for additional gas		m	30	30	30	30
Additional gas amount		g/m	45	45	45	45
Refrigerant (R32) / CO ₂ Eq.		kg / T	1,95/1,32	3,05/2,06	3,05/2,06	3,05/2,06
Operating range	Cool Min ~ Max	°C	-15 ~ +48	-20 ~ +48 ⁹⁾	-20 ~ +48 ⁹⁾	-20 ~ +48 ⁹⁾
	Heat Min ~ Max	°C	-20 ~ +24	-20 ~ +24	-20 ~ +24	-20 ~ +24

Accessories

CZ-RTC6	CONEX wired remote controller (non-wireless)
CZ-RTC6BL	CONEX wired remote controller with Bluetooth®
CZ-RTC6BLW	CONEX wired remote controller with Wi-Fi and Bluetooth®
CZ-RTC5B	Wired remote controller with Econavi function and datanavi
CZ-RWS3 + CZ-RWRU3W	Infrared remote controller
CZ-CAPWFC1	Commercial Wi-Fi Adaptor

Accessories

CZ-KPU3AW	Econavi exclusive panel
PAW-WTRAY	Tray for condenser water compatible with outdoor elevation platform
PAW-GRDBSE20	Outdoor base ground support for noise and vibration absorption
PAW-GRDSTD40	Outdoor elevation platform 400 x 900 x 400 mm
CZ-FDU3+CZ-ATU2	Fresh air-intake kit

1) EER and COP calculation is based in accordance to EN14511. 2) For models below 12 kW, the SEER and SCOP is calculated based on values of EU/626/2011. For models above 12 kW, the η_{sc} / η_{sh} values is calculated based on EN 14825. 3) Factory setting. 4) The sound pressure of the units shows the value measured of the position 1,5 m below the unit. The sound pressure is measured in accordance with Eurovent 6/C/006-97 specification. 5) Connect the liquid socket tube (Ø6,35-Ø9,52) to the liquid tubing side indoor unit. 6) Connect the gas socket tube (Ø12,70-Ø15,88) to the gas tubing side indoor unit. 7) When installing the outdoor unit at a higher position than the indoor unit. 8) Outdoor unit located lower / outdoor unit located higher. 9) For models 100 ~ 140PZH3E5(8), it is possible to operate the lowest -20 °C in the computer rooms with the piping length of 30 m or less.* Recommended fuse for the indoor 3 A. ** Above values are in the case of nanoe™ X OFF.



SEER and SCOP: For S-3650PU3E + U-36PZH3E5. ECONAVI and INTERNET CONTROL: Optional.

Rating Conditions: Cooling Indoor 27 °C DB / 19 °C WB. Cooling Outdoor 35 °C DB / 24 °C WB. Heating Indoor 20 °C DB. Heating Outdoor 7 °C DB / 6 °C WB. (DB: Dry Bulb; WB: Wet Bulb). Specifications subject to change without notice. For detailed information about ErP / Energy Labelling, please visit our websites www.aircon.panasonic.eu or www.ptc.panasonic.eu.

NEW
2021

nanoe™ X
nanoe™ X as a standard.

NEW PACi NX Series Standard 4 way 90x90 cassette Inverter+ • R32

New 4 way 90x90 cassette - PU3.

Powerful turbo fan and intelligent Econavi sensor ensure high energy efficiency, and nanoe™ X which is equipped as standard provides an exceptional level of indoor air quality.

		Single phase							
			3,6 kW	5,0 kW	6,0 kW	7,1 kW	10,0 kW	12,5 kW	14,0 kW
Kit			KIT-36PU3Z5	KIT-50PU3Z5	KIT-60PU3Z5	KIT-71PU3Z5	KIT-100PU3Z5	KIT-125PU3Z5	KIT-140PU3Z5
Remote controller			CZ-RTC5B	CZ-RTC5B	CZ-RTC5B	CZ-RTC5B	CZ-RTC5B	CZ-RTC5B	CZ-RTC5B
Cooling capacity	Nominal (Min - Max)	kW	3,6(1,5 - 4,0)	5,0(1,5 - 5,6)	6,0(2,0 - 7,1)	7,1(2,6 - 7,7)	10,0(3,0 - 11,5)	12,5(3,2 - 13,5)	14,0(3,3 - 15,0)
EER ¹⁾	Nominal (Min - Max)	W/W	4,34	3,91	3,73	3,27	3,82(5,36 - 2,88)	3,58(5,33 - 2,81)	3,23(5,32 - 2,73)
SEER / ηsc ²⁾			8,1 A++	8,0 A++	7,8 A++	6,8 A++	6,8 A++	267,1 %	257,3 %
Pdesign		kW	3,6	5,0	6,0	7,1	10,0	12,5	14,0
Input power cooling	Nominal (Min - Max)	kW	0,83	1,28	1,61	2,17	2,62(0,56 - 4,00)	3,49(0,60 - 4,80)	4,34(0,62 - 5,50)
Annual energy consumption ³⁾		kWh/a	156	219	269	365	515	—	—
Heating capacity	Nominal (Min - Max)	kW	3,6(1,5 - 4,6)	5,0(1,5 - 6,4)	6,0(1,8 - 7,0)	7,1(2,1 - 8,1)	10,0(3,0 - 14,0)	12,5(3,3 - 15,0)	14,0(3,4 - 16,0)
COP ¹⁾	Nominal (Min - Max)	W/W	5,07	4,63	4,48	4,23	4,93(5,36 - 3,59)	4,43(5,50 - 3,57)	4,18(5,48 - 3,33)
SCOP / ηsc ²⁾			4,8 A++	4,7 A++	4,9 A++	4,6 A++	4,4 A+	157,3 %	152,4 %
Pdesign at -10 °C		kW	2,8	4,0	4,6	5,2	10,0	12,5	14,0 (at -7 °C)
Input power heating	Nominal (Min - Max)	kW	0,71	1,08	1,34	1,68	2,03(0,56 - 3,90)	2,82(0,60 - 4,20)	3,35(0,62 - 4,80)
Annual energy consumption ³⁾		kWh/a	817	1191	1314	1583	3182	—	—
Indoor unit			S-3650PU3E	S-3650PU3E	S-6071PU3E	S-6071PU3E	S-1014PU3E	S-1014PU3E	S-1014PU3E
Air flow	Hi / Med / Lo	m ³ /min	14,5/13,0/11,5	16,5/13,5/11,5	21,0/16,0/13,0	22,0/16,0/13,0	36,0/26,0/18,0	37,0/27,0/19,0	38,0/29,0/20,0
Moisture removal volume		L/h	0,7	1,6	1,7	2,5	2,7	4,8	6,0
Sound pressure ⁴⁾	Hi / Med / Lo	dB(A)	30/28/27	32/29/27	36/31/28	37/31/28	45/38/32	46/39/33	47/40/34
Sound power	Hi / Med / Lo	dB(A)	45/43/42	47/44/42	51/46/43	52/46/43	60/53/47	61/54/48	62/55/49
Dimension	Indoor (HxWxD)	mm	256x840x840	256x840x840	256x840x840	256x840x840	319x840x840	319x840x840	319x840x840
	Panel (HxWxD)	mm	33,5x950x950	33,5x950x950	33,5x950x950	33,5x950x950	33,5x950x950	33,5x950x950	33,5x950x950
Net weight	Indoor / Panel	kg	19/5	19/5	20/5	20/5	25/5	25/5	25/5
nanoe X Generator			Mark 1	Mark 1	Mark 1	Mark 1	Mark 1	Mark 1	Mark 1
Outdoor unit			U-36PZ3E5	U-50PZ3E5	U-60PZ3E5A	U-71PZ3E5A	U-100PZ3E5	U-125PZ3E5	U-140PZ3E5
Power source		V	220 - 230 - 240	220 - 230 - 240	220 - 230 - 240	220 - 230 - 240	220 - 230 - 240	220 - 230 - 240	220 - 230 - 240
Current	Cool	A	3,85 - 3,70 - 3,55	5,95 - 5,70 - 5,45	7,45 - 7,15 - 6,85	10,00 - 9,65 - 9,25	13,10 - 12,50 - 12,00	16,90 - 16,10 - 15,40	21,00 - 20,00 - 19,20
	Heat	A	3,35 - 3,20 - 3,05	5,05 - 4,85 - 4,65	6,20 - 5,95 - 5,70	7,80 - 7,45 - 7,15	10,10 - 9,70 - 9,30	13,60 - 13,00 - 12,50	16,20 - 15,50 - 14,80
Air flow	Cool / Heat	m ³ /min	33,6/34,0	32,7/31,9	42,6/41,5	44,7/45,9	73,0/73,0	82,0/80,0	84,0/82,0
Sound pressure	Cool / Heat (Hi)	dB(A)	46/47	46/46	47/48	48/49	52/52	55/55	56/56
Sound power	Cool / Heat (Hi)	dB(A)	64/66	64/64	64/65	66/68	70/70	73/73	74/74
Dimension	HxWxD	mm	619x824x299	619x824x299	695x875x320	695x875x320	996x980x370	996x980x370	996x980x370
Net weight		kg	32	35	42	50	83	87	87
Pipe diameter	Liquid pipe	Inch (mm)	1/4(6,35)	1/4(6,35)	1/4(6,35) ⁵⁾	1/4(6,35) ⁵⁾	3/8(9,52)	3/8(9,52)	3/8(9,52)
	Gas pipe	Inch (mm)	1/2(12,70)	1/2(12,70)	1/2(12,70) ⁶⁾	5/8(15,88)	5/8(15,88)	5/8(15,88)	5/8(15,88)
Pipe length range		m	3 - 15	3 - 20	3 - 40	3 - 40	5 - 50	5 - 50	5 - 50
Elevation difference (in/out) ⁷⁾		m	15/15 ⁸⁾	15/15 ⁸⁾	15/30 ⁸⁾	20/30 ⁸⁾	15/30 ⁸⁾	15/30 ⁸⁾	15/30 ⁸⁾
Pipe length for additional gas		m	7,5	7,5	30	30	30	30	30
Additional gas amount		g/m	10	15	15	17	45	45	45
Refrigerant (R32) / CO ₂ , Eq.		kg / T	0,87/0,59	1,14/0,77	1,15/0,78	1,32/0,89	2,40/1,62	2,80/1,89	2,80/1,89
Operating range	Cool Min - Max	°C	-10 ~ +43	-10 ~ +43	-10 ~ +43	-10 ~ +43	-10 ~ +43	-10 ~ +43	-10 ~ +43
	Heat Min - Max	°C	-15 ~ +24	-15 ~ +24	-15 ~ +24	-15 ~ +24	-15 ~ +24	-15 ~ +24	-15 ~ +24

Technical focus

- High performance turbo fan, path system for heat exchanger
- Econavi: An optional intelligent sensor to reduce waste of energy
- nanoe™ X (Generator Mark 1= 4,8 trillion hydroxyl radicals/sec) as standard for better indoor air quality, indoor unit internal cleaning with nanoe™ X and dry operation
- Lower noise in slow fan operation
- Light weight, easy piping and integrated drain pump for quick installation
- Wired remote control CZ-RTC6BL allows easy system setting via Bluetooth®
- High volume fresh air input with optional air-intake plenum and chamber (CZ-FDU3+CZ-ATU2)



Standard panel.
CZ-KPU3W

COMPATIBLE WITH ALL PANASONIC
CONNECTIVITY SOLUTIONS

CZ-RTC5B



Optional
Econavi panel
(CZ-RTC5B is
required).
CZ-KPU3AW



Optional controller.
CONEX wired remote
controller.
CZ-RTC6 - CZ-RTC6BL
- CZ-RTC6BLW



Optional controller.
Infrared remote
controller.
CZ-RWS3 +
CZ-RWRU3W

			Three phase		
			10,0 kW	12,5 kW	14,0 kW
Kit			KIT-100PU3Z8	KIT-125PU3Z8	KIT-140PU3Z8
Remote controller			CZ-RTC5B	CZ-RTC5B	CZ-RTC5B
Cooling capacity	Nominal (Min - Max)	kW	10,0(3,0 - 11,5)	12,5(3,2 - 13,5)	14,0(3,3 - 15,0)
EER ¹⁾	Nominal (Min - Max)	W/W	3,82(5,36 - 2,88)	3,58(5,33 - 2,81)	3,23(5,32 - 2,73)
SEER / η _{sc} ²⁾			6,7 A++	266,1 %	256,5 %
P _{design}		kW	10,0	12,5	14,0
Input power cooling	Nominal (Min - Max)	kW	2,62(0,56 - 4,00)	3,49(0,60 - 4,80)	4,34(0,62 - 5,50)
Annual energy consumption ³⁾		kWh/a	521	—	—
Heating capacity	Nominal (Min - Max)	kW	10,0(3,0 - 14,0)	12,5(3,3 - 15,0)	14,0(3,4 - 16,0)
COP ¹⁾	Nominal (Min - Max)	W/W	4,93(5,36 - 3,59)	4,43(5,50 - 3,57)	4,18(5,48 - 3,33)
SCOP / η _{sc} ²⁾			4,4 A+	157,3 %	152,4 %
P _{design} at -10 °C		kW	10,0	12,5	14,0 (at -7 °C)
Input power heating	Nominal (Min - Max)	kW	2,03(0,56 - 3,90)	2,82(0,60 - 4,20)	3,35(0,62 - 4,80)
Annual energy consumption ³⁾		kWh/a	3182	—	—
Indoor unit			S-1014PU3E	S-1014PU3E	S-1014PU3E
Air flow	Hi / Med / Lo	m ³ /min	36,0/26,0/18,0	37,0/27,0/19,0	38,0/29,0/20,0
Moisture removal volume		L/h	2,7	4,8	6,0
Sound pressure ⁴⁾	Hi / Med / Lo	dB(A)	45/38/32	46/39/33	47/40/34
Sound power	Hi / Med / Lo	dB(A)	60/53/47	61/54/48	62/55/49
Dimension	Indoor (HxWxD)	mm	319 x 840 x 840	319 x 840 x 840	319 x 840 x 840
	Panel (HxWxD)	mm	33,5 x 950 x 950	33,5 x 950 x 950	33,5 x 950 x 950
Net weight	Indoor / Panel	kg	25/5	25/5	25/5
nanoe X Generator			Mark 1	Mark 1	Mark 1
Outdoor unit			U-100PZ3E8	U-125PZ3E8	U-140PZ3E8
Power source		V	380 - 400 - 415	380 - 400 - 415	380 - 400 - 415
Current	Cool	A	4,35 - 4,15 - 4,00	5,65 - 5,35 - 5,15	7,00 - 6,65 - 6,40
	Heat	A	3,40 - 3,20 - 3,10	4,55 - 4,35 - 4,15	5,40 - 5,15 - 4,95
Air flow	Cool / Heat	m ³ /min	73,0/73,0	82,0/80,0	84,0/82,0
Sound pressure	Cool / Heat (Hi)	dB(A)	52/52	55/55	56/56
Sound power	Cool / Heat (Hi)	dB(A)	70/70	73/73	74/74
Dimension	H x W x D	mm	996 x 980 x 370	996 x 980 x 370	996 x 980 x 370
Net weight		kg	83	87	87
Pipe diameter	Liquid pipe	Inch (mm)	3/8(9,52)	3/8(9,52)	3/8(9,52)
	Gas pipe	Inch (mm)	5/8(15,88)	5/8(15,88)	5/8(15,88)
Pipe length range		m	5 - 50	5 - 50	5 - 50
Elevation difference (in/out) ⁷⁾		m	15/30 ⁸⁾	15/30 ⁸⁾	15/30 ⁸⁾
Pipe length for additional gas		m	30	30	30
Additional gas amount		g/m	45	45	45
Refrigerant (R32) / CO ₂ Eq.		kg / T	2,40/1,62	2,80/1,89	2,80/1,89
Operating range	Cool Min ~ Max	°C	-10 ~ +43	-10 ~ +43	-10 ~ +43
	Heat Min ~ Max	°C	-15 ~ +24	-15 ~ +24	-15 ~ +24

Accessories

CZ-RTC6	CONEX wired remote controller (non-wireless)
CZ-RTC6BL	CONEX wired remote controller with Bluetooth®
CZ-RTC6BLW	CONEX wired remote controller with Wi-Fi and Bluetooth®
CZ-RTC5B	Wired remote controller with Econavi function and datanavi
CZ-RWS3 + CZ-RWRU3W	Infrared remote controller
CZ-CAPWFC1	Commercial Wi-Fi Adaptor

Accessories

CZ-KPU3AW	Econavi exclusive panel
PAW-WTRAY	Tray for condenser water compatible with outdoor elevation platform
PAW-GRDBSE20	Outdoor base ground support for noise and vibration absorption
PAW-GRDSTD40	Outdoor elevation platform 400 x 900 x 400 mm
CZ-FDU3+CZ-ATU2	Fresh air-intake kit

1) EER and COP calculation is based in accordance to EN14511. 2) For models below 12 kW, the SEER and SCOP is calculated based on values of EU/626/2011. For models above 12 kW, the η_{sc} / η_{sh} values is calculated based on EN 14825. 3) Factory setting. 4) The sound pressure of the units shows the value measured of the position 1,5 m below the unit. The sound pressure is measured in accordance with Eurovent 6/C/006-97 specification. 5) Connect the liquid socket tube (Ø6,35-Ø9,52) to the liquid tubing side indoor unit. 6) Connect the gas socket tube (Ø12,70-Ø15,88) to the gas tubing side indoor unit. 7) When installing the outdoor unit at a higher position than the indoor unit. 8) Outdoor unit located lower / outdoor unit located higher. * Recommended fuse for the indoor 3 A. ** Above values are in the case of nanoe™ X OFF.



SEER: For S-3650PU3E + U-36PZ3E5. SCOP: For S-3650PU3E + U-60PZ3E5A. ECONAVI and INTERNET CONTROL: Optional.

Rating Conditions: Cooling Indoor 27 °C DB / 19 °C WB. Cooling Outdoor 35 °C DB / 24 °C WB. Heating Indoor 20 °C DB. Heating Outdoor 7 °C DB / 6 °C WB. (DB: Dry Bulb; WB: Wet Bulb). Specifications subject to change without notice. For detailed information about ErP / Energy Labelling, please visit our websites www.aircon.panasonic.eu or www.ptc.panasonic.eu.

NEW
2021

nanoe™ X

nanoe™ X as a standard.



NEW PACi NX Series Elite ceiling Inverter+ • R32

Ceiling mounted units provide large and wide air distribution which is good for big rooms.

The height and depth of all capacities are the same for unified appearance in mixed installations.

		Single phase								
			3,6 kW	5,0 kW	6,0 kW	7,1 kW	10,0 kW	12,5 kW	14,0 kW	
Kit			KIT-36PT3ZH5	KIT-50PT3ZH5	KIT-60PT3ZH5	KIT-71PT3ZH5	KIT-100PT3ZH5	KIT-125PT3ZH5	KIT-140PT3ZH5	
Remote controller			CZ-RTC5B	CZ-RTC5B	CZ-RTC5B	CZ-RTC5B	CZ-RTC5B	CZ-RTC5B	CZ-RTC5B	
Cooling capacity	Nominal (Min - Max)	kW	3,5(1,2 - 4,0)	5,0(1,2 - 5,6)	6,0(1,2 - 7,1)	6,8(2,2 - 9,0)	9,5(3,1 - 12,5)	12,1(3,2 - 14,0)	13,4(3,3 - 16,0)	
EER ¹⁾		W/W	4,86	4,03	3,82	3,91	4,15	3,51	3,21	
SEER / η _{sc} ²⁾			7,7 A++	7,4 A++	7,5 A++	7,3 A++	7,3 A++	278,4 %	263,3 %	
P _{design}		kW	3,5	5,0	6,0	6,8	9,5	12,1	13,4	
Input power cooling		kW	0,720	1,24	1,57	1,74	2,29	3,45	4,17	
Annual energy consumption ³⁾		kWh/a	160	237	280	326	456	—	—	
Heating capacity	Nominal (Min - Max)	kW	4,0(1,2 - 5,0)	5,6(1,2 - 6,5)	7,0(1,2 - 8,0)	8,0(2,0 - 9,0)	11,2(3,1 - 14,0)	14,0(3,2 - 16,0)	16,0(3,3 - 18,0)	
COP ¹⁾		W/W	5,00	4,03	4,14	3,96	4,09	3,78	3,48	
SCOP / η _{sc} ²⁾			4,9 A++	4,8 A++	4,8 A++	4,7 A++	4,7 A++	181,0 %	178,0 %	
P _{design} at -10 °C		kW	3,1	4,0	4,6	4,7	7,8	9,5	10,2	
Input power heating		kW	0,80	1,39	1,69	2,02	2,74	3,70	4,60	
Annual energy consumption ³⁾		kWh/a	886	1167	1342	1400	2323	—	—	
Indoor unit			S-3650PT3E	S-3650PT3E	S-6071PT3E	S-6071PT3E	S-1014PT3E	S-1014PT3E	S-1014PT3E	
Air flow	Hi / Med / Lo	m ³ /min	14,0/12,0/10,5	15,0/12,5/10,5	20,0/17,0/14,5	21,0/18,0/15,5	30,0/25,0/23,0	34,0/28,0/24,0	35,0/29,0/25,0	
Moisture removal volume		L/h	0,8	2,0	2,1	2,7	3,6	5,4	6,4	
Sound pressure ⁴⁾	Hi / Med / Lo	dB(A)	36/32/28	37/33/28	38/34/29	39/35/30	42/37/34	46/40/35	47/41/36	
Sound power	Hi / Med / Lo	dB(A)	54/50/46	55/51/46	56/52/47	57/53/48	60/55/52	64/58/53	65/59/54	
Dimension	HxWxD	mm	235x960x690	235x960x690	235x1275x690	235x1275x690	235x1590x690	235x1590x690	235x1590x690	
Net weight		kg	26	26	34	34	40	40	40	
nanoe X Generator			Mark 2	Mark 2	Mark 2	Mark 2	Mark 2	Mark 2	Mark 2	
Outdoor unit			U-36PZH3E5	U-50PZH3E5	U-60PZH3E5	U-71PZH3E5	U-100PZH3E5	U-125PZH3E5	U-140PZH3E5	
Power source		V	220 - 230 - 240	220 - 230 - 240	220 - 230 - 240	220 - 230 - 240	220 - 230 - 240	220 - 230 - 240	220 - 230 - 240	
Current	Cool	A	3,55 - 3,40 - 3,25	5,85 - 5,60 - 5,40	7,35 - 7,05 - 6,75	8,60 - 8,20 - 7,90	11,30 - 10,80 - 10,40	16,90 - 16,10 - 15,50	20,40 - 19,50 - 18,70	
	Heat	A	3,90 - 3,75 - 3,60	6,60 - 6,30 - 6,05	7,85 - 7,50 - 7,20	9,75 - 9,45 - 9,05	13,40 - 12,90 - 12,40	18,10 - 17,30 - 16,60	22,50 - 21,50 - 20,60	
Air flow	Cool / Heat	m ³ /min	34,1/36,4	42,0/42,0	42,0/42,0	61,0/60,0	118,0/108,0	125,0/112,0	129,0/116,0	
Sound pressure	Cool / Heat (Hi)	dB(A)	43/44	46/48	47/50	48/50	52/52	53/53	54/54	
Sound power	Cool / Heat (Hi)	dB(A)	62/64	64/67	65/69	65/67	69/69	70/70	71/71	
Dimension	HxWxD	mm	695x875x320	695x875x320	695x875x320	996x940x340	1416x940x340	1416x940x340	1416x940x340	
Net weight		kg	42	42	43	65	98	98	98	
Pipe diameter	Liquid pipe	Inch (mm)	1/4(6,35)	1/4(6,35)	1/4(6,35) ⁵⁾	3/8(9,52)	3/8(9,52)	3/8(9,52)	3/8(9,52)	
Pipe diameter	Gas pipe	Inch (mm)	1/2(12,70)	1/2(12,70)	1/2(12,70) ⁶⁾	5/8(15,88)	5/8(15,88)	5/8(15,88)	5/8(15,88)	
Pipe length range		m	3 - 40	3 - 40	3 - 40	5 - 50	5 - 85	5 - 85	5 - 85	
Elevation difference (in/out) ⁷⁾		m	15/30 ⁸⁾	15/30 ⁸⁾	15/30 ⁸⁾	15/30 ⁸⁾	15/30 ⁸⁾	15/30 ⁸⁾	15/30 ⁸⁾	
Pipe length for additional gas		m	30	30	30	30	30	30	30	
Additional gas amount		g/m	15	15	15	45	45	45	45	
Refrigerant (R32) / CO ₂ Eq.		kg / T	1,13/0,76	1,13/0,76	1,15/0,78	1,95/1,32	3,05/2,06	3,05/2,06	3,05/2,06	
Operating range	Cool Min - Max	°C	-15 ~ +46	-15 ~ +46	-15 ~ +46	-15 ~ +48	-20 ~ +48 ⁹⁾	-20 ~ +48 ⁹⁾	-20 ~ +48 ⁹⁾	
	Heat Min - Max	°C	-20 ~ +24	-20 ~ +24	-20 ~ +24	-20 ~ +24	-20 ~ +24	-20 ~ +24	-20 ~ +24	

Technical focus

- Wide air distribution for large rooms
- Horizontal air flow reaches maximum 9,5 m
- Fresh air connection available on the unit
- Slim design with 235 mm height fits narrow space
- Silent operation
- nanoe™ X (Generator Mark 2= 9,6 trillion hydroxyl radicals/sec) as standard for better indoor air quality
- Wired remote control CZ-RTC6BL allows easy system setting via Bluetooth®
- Twin, Triple and Double-twin split options
- Easy connection and control of external fan or ERV using the connector PAW-FDC on the indoor unit PCB. The external device can be controlled by the remote control of the Panasonic indoor unit

Further comfort improvement with airflow distribution

Horizontal air flow reaches maximum 9,5 m. This is ideal for wide rooms.

The wide air discharge opening expands the air flow to the left and the right. The unpleasant feeling caused when the air flow directly hits the human body is prevented by the "Draft prevention position", which changes the swing width, so that the degree of comfort is increased.



CZ-RTC5B



CONEX



Optional controller.
CONEX wired remote
controller.
CZ-RTC6 - CZ-RTC6BL
- CZ-RTC6BLW



Optional controller.
Infrared remote
controller.
CZ-RWS3 +
CZ-RWRT3



Optional Econavi
sensor.
CZ-CENSC1

COMPATIBLE WITH ALL PANASONIC
CONNECTIVITY SOLUTIONS

Three phase

			7,1 kW	10,0 kW	12,5 kW	14,0 kW
Kit			KIT-71PT3ZH8	KIT-100PT3ZH8	KIT-125PT3ZH8	KIT-140PT3ZH8
Remote controller			CZ-RTC5B	CZ-RTC5B	CZ-RTC5B	CZ-RTC5B
Cooling capacity	Nominal (Min - Max)	kW	6,8(2,2 - 9,0)	9,5(3,1 - 12,5)	12,1(3,2 - 14,0)	13,4(3,3 - 16,0)
EER ¹⁾		W/W	3,91	4,15	3,51	3,21
SEER / η _{sc} ²⁾			7,2 A++	7,2 A++	277,3 %	262,4 %
P _{design}		kW	6,8	9,5	12,1	13,4
Input power cooling		kW	1,74	2,29	3,45	4,17
Annual energy consumption ³⁾		kWh/a	331	462	—	—
Heating capacity	Nominal (Min - Max)	kW	8,0(2,0 - 9,0)	11,2(3,1 - 14,0)	14,0(3,2 - 16,0)	16,0(3,3 - 18,0)
COP ¹⁾		W/W	3,96	4,09	3,78	3,48
SCOP / η _{sc} ²⁾			4,7 A++	4,7 A++	180,9 %	178,0 %
P _{design} at -10 °C		kW	4,7	7,8	9,5	10,2
Input power heating		kW	2,02	2,74	3,7	4,6
Annual energy consumption ³⁾		kWh/a	1400	2324	—	—
Indoor unit			S-6071PT3E	S-1014PT3E	S-1014PT3E	S-1014PT3E
Air flow	Hi / Med / Lo	m ³ /min	21,0/18,0/15,5	30,0/25,0/23,0	34,0/28,0/24,0	35,0/29,0/25,0
Moisture removal volume		L/h	2,7	3,6	5,4	6,4
Sound pressure ⁴⁾	Hi / Med / Lo	dB(A)	39/35/30	42/37/34	46/40/35	47/41/36
Sound power	Hi / Med / Lo	dB(A)	57/53/48	60/55/52	64/58/53	65/59/54
Dimension	HxWxD	mm	235x1275x690	235x1590x690	235x1590x690	235x1590x690
Net weight		kg	34	40	40	40
nanoe X Generator			Mark 2	Mark 2	Mark 2	Mark 2
Outdoor unit			U-71PZH3E8	U-100PZH3E8	U-125PZH3E8	U-140PZH3E8
Power source		V	380 - 400 - 415	380 - 400 - 415	380 - 400 - 415	380 - 400 - 415
Current	Cool	A	2,90 - 2,80 - 2,70	3,80 - 3,65 - 3,45	5,70 - 5,40 - 5,20	6,90 - 6,55 - 6,30
	Heat	A	3,35 - 3,20 - 3,10	4,55 - 4,35 - 4,15	6,20 - 5,85 - 5,65	7,70 - 7,30 - 6,95
Air flow	Cool / Heat	m ³ /min	61,0/60,0	118,0/108,0	125,0/112,0	129,0/116,0
Sound pressure	Cool / Heat (Hi)	dB(A)	48/50	52/52	53/53	54/54
Sound power	Cool / Heat (Hi)	dB(A)	65/67	69/69	70/70	71/71
Dimension	HxWxD	mm	996x940x340	1416x940x340	1416x940x340	1416x940x340
Net weight		kg	65	98	98	98
Pipe diameter	Liquid pipe	Inch (mm)	3/8(9,52)	3/8(9,52)	3/8(9,52)	3/8(9,52)
	Gas pipe	Inch (mm)	5/8(15,88)	5/8(15,88)	5/8(15,88)	5/8(15,88)
Pipe length range		m	5 - 50	5 - 85	5 - 85	5 - 85
Elevation difference (in/out) ⁷⁾		m	15/30 ⁸⁾	15/30 ⁸⁾	15/30 ⁸⁾	15/30 ⁸⁾
Pipe length for additional gas		m	30	30	30	30
Additional gas amount		g/m	45	45	45	45
Refrigerant (R32) / CO ₂ Eq.		kg / T	1,95/1,32	3,05/2,06	3,05/2,06	3,05/2,06
Operating range	Cool Min ~ Max	°C	-15 ~ +48	-20 ~ +48 ⁹⁾	-20 ~ +48 ⁹⁾	-20 ~ +48 ⁹⁾
	Heat Min ~ Max	°C	-20 ~ +24	-20 ~ +24	-20 ~ +24	-20 ~ +24

Accessories

CZ-RTC6	CONEX wired remote controller (non-wireless)
CZ-RTC6BL	CONEX wired remote controller with Bluetooth®
CZ-RTC6BLW	CONEX wired remote controller with Wi-Fi and Bluetooth®
CZ-RTC5B	Wired remote controller with Econavi function and datanavi
CZ-RWS3 + CZ-RWRT3	Infrared remote controller

Accessories

CZ-CAPWFC1	Commercial Wi-Fi Adaptor
PAW-WTRAY	Tray for condenser water compatible with outdoor elevation platform
PAW-GRDBSE20	Outdoor base ground support for noise and vibration absorption
PAW-GRDSTD40	Outdoor elevation platform 400x900x400 mm
CZ-CENSC1	Econavi energy savings sensor

1) EER and COP calculation is based in accordance to EN14511. 2) For models below 12 kW, the SEER and SCOP is calculated based on values of EU/626/2011. For models above 12 kW, the η_{sc} / η_{sh} values is calculated based on EN 14825. 3) Factory setting. 4) The sound pressure of the units shows the value measured of the position 1 m in front of the main body and 1 m below the unit. The sound pressure is measured in accordance with Eurovent 6/C/006-97 specification. 5) Connect the liquid socket tube (Ø6,35-Ø9,52) to the liquid tubing side indoor unit. 6) Connect the gas socket tube (Ø12,70-Ø15,88) to the gas tubing side indoor unit. 7) When installing the outdoor unit at a higher position than the indoor unit. 8) Outdoor unit located lower / outdoor unit located higher. 9) For models 100 - 140PZH3E5(8), it is possible to operate the lowest -20 °C in the computer rooms with the piping length of 30 m or less.* Recommended fuse for the indoor 3 A.



SEER and SCOP: For S-3650PT3E + U-36PZH3E5. INTERNET CONTROL: Optional.

Rating Conditions: Cooling Indoor 27 °C DB / 19 °C WB. Cooling Outdoor 35 °C DB / 24 °C WB. Heating Indoor 20 °C DB. Heating Outdoor 7 °C DB / 6 °C WB. (DB: Dry Bulb; WB: Wet Bulb). Specifications subject to change without notice. For detailed information about ErP / Energy Labelling, please visit our websites www.aircon.panasonic.eu or www.ptc.panasonic.eu.

NEW
2021

nanoe™ X as a standard.

NEW PACi NX Series Standard ceiling Inverter+ • R32

Ceiling mounted units provide large and wide air distribution which is good for big rooms.

The height and depth of all capacities are the same for unified appearance in mixed installations.

		Single phase							
Kit			3,6 kW	5,0 kW	6,0 kW	7,1 kW	10,0 kW	12,5 kW	14,0 kW
Remote controller			KIT-36PT3Z5	KIT-50PT3Z5	KIT-60PT3Z5	KIT-71PT3Z5	KIT-100PT3Z5	KIT-125PT3Z5	KIT-140PT3Z5
			CZ-RTC5B	CZ-RTC5B	CZ-RTC5B	CZ-RTC5B	CZ-RTC5B	CZ-RTC5B	CZ-RTC5B
Cooling capacity	Nominal (Min - Max)	kW	3,5(1,5 - 4,0)	5,0(1,5 - 5,2)	6,0(2,0 - 7,1)	6,8(2,6 - 7,7)	10,0(3,0 - 11,5)	12,5(3,2 - 13,5)	14,0(3,3 - 15,0)
EER ¹⁾		W/W	4,14	3,03	3,59	3,24	3,64	3,32	2,98
SEER / η _{sc} ²⁾			7,2 A++	6,7 A++	7,3 A++	5,9 A+	6,6 A++	241,7 %	228,8 %
P _{design}		kW	3,5	5,0	6,0	6,8	10,0	12,5	14,0
Input power cooling		kW	0,85	1,65	1,67	2,10	2,75	3,76	4,70
Annual energy consumption ³⁾		kWh/a	171	262	288	404	531	—	—
Heating capacity	Nominal (Min - Max)	kW	3,5(1,5 - 4,6)	5,0(1,5 - 6,4)	6,0(1,8 - 7,0)	6,8(2,1 - 8,1)	10,0(3,0 - 14,0)	12,5(3,3 - 15,0)	14,0(3,4 - 16,0)
COP ¹⁾		W/W	4,61	3,73	4,11	4,20	4,24	3,89	3,70
SCOP / η _{sc} ²⁾			4,4 A+	4,1 A+	4,6 A++	4,3 A+	4,2 A+	147,4 %	145,3 %
P _{design} at -10 °C		kW	2,8	4,0	4,6	4,7	10,0	12,5	13,6
Input power heating		kW	0,76	1,34	1,46	1,62	2,36	3,21	3,78
Annual energy consumption ³⁾		kWh/a	891	1365	1399	1529	3331	—	—
Indoor unit			S-3650PT3E	S-3650PT3E	S-6071PT3E	S-6071PT3E	S-1014PT3E	S-1014PT3E	S-1014PT3E
Air flow	Hi / Med / Lo	m ³ /min	14,0/12,0/10,5	15,0/12,5/10,5	20,0/17,0/14,5	21,0/18,0/15,5	30,0/25,0/23,0	34,0/28,0/24,0	35,0/29,0/25,0
Moisture removal volume		L/h	0,8	2,0	2,1	2,7	4,1	5,7	6,9
Sound pressure ⁴⁾	Hi / Med / Lo	dB(A)	36/32/28	37/33/28	38/34/29	39/35/30	42/37/34	46/40/35	47/41/36
Sound power	Hi / Med / Lo	dB(A)	54/50/46	55/51/46	56/52/47	57/53/48	60/55/52	64/58/53	65/59/54
Dimension	HxWxD	mm	235x960x690	235x960x690	235x1275x690	235x1275x690	235x1590x690	235x1590x690	235x1590x690
Net weight		kg	26	26	34	34	40	40	40
nanoe X Generator			Mark 2	Mark 2	Mark 2	Mark 2	Mark 2	Mark 2	Mark 2
Outdoor unit			U-36PZ3E5	U-50PZ3E5	U-60PZ3E5A	U-71PZ3E5A	U-100PZ3E5	U-125PZ3E5	U-140PZ3E5
Power source		V	220 - 230 - 240	220 - 230 - 240	220 - 230 - 240	220 - 230 - 240	220 - 230 - 240	220 - 230 - 240	220 - 230 - 240
Current	Cool	A	3,90 - 3,75 - 3,60	7,65 - 7,30 - 7,00	7,75 - 7,40 - 7,10	9,75 - 9,30 - 8,95	13,70 - 13,10 - 12,60	18,20 - 17,40 - 16,70	22,70 - 21,70 - 20,80
	Heat	A	3,55 - 3,40 - 3,25	6,30 - 6,00 - 5,75	6,75 - 6,50 - 6,20	7,50 - 7,20 - 6,90	11,80 - 11,30 - 10,80	15,50 - 14,80 - 14,20	18,30 - 17,50 - 16,80
Air flow	Cool / Heat	m ³ /min	33,6/34,0	32,7/31,9	42,6/41,5	44,7/45,9	73,0/73,0	82,0/80,0	84,0/82,0
Sound pressure	Cool / Heat (Hi)	dB(A)	46/47	46/46	47/48	48/49	52/52	55/55	56/56
Sound power	Cool / Heat (Hi)	dB(A)	64/66	64/64	64/65	66/68	70/70	73/73	74/74
Dimension	HxWxD	mm	619x824x299	619x824x299	695x875x320	695x875x320	996x980x370	996x980x370	996x980x370
Net weight		kg	32	35	42	50	83	87	87
Pipe diameter	Liquid pipe	Inch (mm)	1/4(6,35)	1/4(6,35)	1/4(6,35) ⁵⁾	1/4(6,35) ⁵⁾	3/8(9,52)	3/8(9,52)	3/8(9,52)
	Gas pipe	Inch (mm)	1/2(12,70)	1/2(12,70)	1/2(12,70) ⁴⁾	5/8(15,88)	5/8(15,88)	5/8(15,88)	5/8(15,88)
Pipe length range		m	3 - 15	3 - 20	3 - 40	3 - 40	5 - 50	5 - 50	5 - 50
Elevation difference (in/out) ⁷⁾		m	15/15 ⁸⁾	15/15 ⁸⁾	15/30 ⁸⁾	20/30 ⁸⁾	15/30 ⁸⁾	15/30 ⁸⁾	15/30 ⁸⁾
Pipe length for additional gas		m	7,5	7,5	30	30	30	30	30
Additional gas amount		g/m	10	15	15	17	45	45	45
Refrigerant (R32) / CO ₂ Eq.		kg / T	0,87/0,59	1,14/0,77	1,15/0,78	1,32/0,89	2,40/1,62	2,80/1,89	2,80/1,89
Operating range	Cool Min - Max	°C	-10 ~ +43	-10 ~ +43	-10 ~ +43	-10 ~ +43	-10 ~ +43	-10 ~ +43	-10 ~ +43
	Heat Min - Max	°C	-15 ~ +24	-15 ~ +24	-15 ~ +24	-15 ~ +24	-15 ~ +24	-15 ~ +24	-15 ~ +24

Technical focus

- Wide air distribution for large rooms
- Horizontal air flow reaches maximum 9,5 m
- Fresh air connection available on the unit
- Slim design with 235 mm height fits narrow space
- Silent operation
- nanoe™ X (Generator Mark 2= 9,6 trillion hydroxyl radicals/sec) as standard for better indoor air quality
- Wired remote control CZ-RTC6BL allows easy system setting via Bluetooth®
- Twin, Triple and Double-twin split options
- Easy connection and control of external fan or ERV using the connector PAW-FDC on the indoor unit PCB. The external device can be controlled by the remote control of the Panasonic indoor unit

Further comfort improvement with airflow distribution

Horizontal air flow reaches maximum 9,5 m. This is ideal for wide rooms.

The wide air discharge opening expands the air flow to the left and the right. The unpleasant feeling caused when the air flow directly hits the human body is prevented by the "Draft prevention position", which changes the swing width, so that the degree of comfort is increased.



CZ-RTC5B



CONEX



Optional controller.
CONEX wired remote
controller.
CZ-RTC6 - CZ-RTC6BL
- CZ-RTC6BLW



Optional controller.
Infrared remote
controller.
CZ-RWS3 +
CZ-RWRT3



Optional Econavi
sensor.
CZ-CENSC1

			Three phase		
			10,0 kW	12,5 kW	14,0 kW
Kit			KIT-100PT3Z8	KIT-125PT3Z8	KIT-140PT3Z8
Remote controller			CZ-RTC5B	CZ-RTC5B	CZ-RTC5B
Cooling capacity	Nominal (Min - Max)	kW	10,0(3,0 - 11,5)	12,5(3,2 - 13,5)	14,0(3,3 - 15,0)
EER ¹⁾		W/W	3,64	3,32	2,98
SEER / η _{sc} ²⁾			6,5 A++	240,9 %	228,1 %
P _{design}		kW	10,0	12,5	14,0
Input power cooling		kW	2,75	3,76	4,70
Annual energy consumption ³⁾		kWh/a	537	—	—
Heating capacity	Nominal (Min - Max)	kW	10,0(3,0 - 14,0)	12,5(3,3 - 15,0)	14,0(3,4 - 16,0)
COP ¹⁾		W/W	4,24	3,89	3,70
SCOP / η _{sc} ²⁾			4,2 A+	147,4 %	145,3 %
P _{design} at -10 °C		kW	10,0	12,5	13,6
Input power heating		kW	2,36	3,21	3,78
Annual energy consumption ³⁾		kWh/a	3331	—	—
Indoor unit			S-1014PT3E	S-1014PT3E	S-1014PT3E
Air flow	Hi / Med / Lo	m ³ /min	30,0/25,0/23,0	34,0/28,0/24,0	35,0/29,0/25,0
Moisture removal volume		L/h	4,1	5,7	6,9
Sound pressure ⁴⁾	Hi / Med / Lo	dB(A)	42/37/34	46/40/35	47/41/36
Sound power	Hi / Med / Lo	dB(A)	60/55/52	64/58/53	65/59/54
Dimension	HxWxD	mm	235 x 1590 x 690	235 x 1590 x 690	235 x 1590 x 690
Net weight		kg	40	40	40
nanoe X Generator			Mark 2	Mark 2	Mark 2
Outdoor unit			U-100PZ3E8	U-125PZ3E8	U-140PZ3E8
Power source		V	380 - 400 - 415	380 - 400 - 415	380 - 400 - 415
Current	Cool	A	4,60 - 4,35 - 4,20	6,10 - 5,75 - 5,55	7,60 - 7,20 - 6,95
	Heat	A	3,95 - 3,75 - 3,60	5,20 - 4,95 - 4,75	6,10 - 5,80 - 5,60
Air flow	Cool / Heat	m ³ /min	73,0/73,0	82,0/80,0	84,0/82,0
Sound pressure	Cool / Heat (Hi)	dB(A)	52/52	55/55	56/56
Sound power	Cool / Heat (Hi)	dB(A)	70/70	73/73	74/74
Dimension	HxWxD	mm	996 x 980 x 370	996 x 980 x 370	996 x 980 x 370
Net weight		kg	83	87	87
Pipe diameter	Liquid pipe	Inch (mm)	3/8(9,52)	3/8(9,52)	3/8(9,52)
	Gas pipe	Inch (mm)	5/8(15,88)	5/8(15,88)	5/8(15,88)
Pipe length range		m	5 - 50	5 - 50	5 - 50
Elevation difference (in/out) ⁷⁾		m	15/30 ⁸⁾	15/30 ⁸⁾	15/30 ⁸⁾
Pipe length for additional gas		m	30	30	30
Additional gas amount		g/m	45	45	45
Refrigerant (R32) / CO ₂ Eq.		kg / T	2,40/1,62	2,80/1,89	2,80/1,89
Operating range	Cool Min ~ Max	°C	-10 ~ +43	-10 ~ +43	-10 ~ +43
	Heat Min ~ Max	°C	-15 ~ +24	-15 ~ +24	-15 ~ +24

Accessories

CZ-RTC6	CONEX wired remote controller (non-wireless)
CZ-RTC6BL	CONEX wired remote controller with Bluetooth®
CZ-RTC6BLW	CONEX wired remote controller with Wi-Fi and Bluetooth®
CZ-RTC5B	Wired remote controller with Econavi function and datanavi
CZ-RWS3 + CZ-RWRT3	Infrared remote controller

Accessories

CZ-CAPWFC1	Commercial Wi-Fi Adaptor
PAW-WTRAY	Tray for condenser water compatible with outdoor elevation platform
PAW-GRDBSE20	Outdoor base ground support for noise and vibration absorption
PAW-GRDSTD40	Outdoor elevation platform 400x900x400 mm
CZ-CENSC1	Econavi energy savings sensor

1) EER and COP calculation is based in accordance to EN14511. 2) For models below 12 kW, the SEER and SCOP is calculated based on values of EU/626/2011. For models above 12 kW, the η_{sc} / η_{sh} values is calculated based on EN 14825. 3) Factory setting. 4) The sound pressure of the units shows the value measured of the position 1 m in front of the main body and 1 m below the unit. The sound pressure is measured in accordance with Eurovent 6/C/006-97 specification. 5) Connect the liquid socket tube (Ø6,35-Ø9,52) to the liquid tubing side indoor unit. 6) Connect the gas socket tube (Ø12,70-Ø15,88) to the gas tubing side indoor unit. 7) When installing the outdoor unit at a higher position than the indoor unit. 8) Outdoor unit located lower / outdoor unit located higher. * Recommended fuse for the indoor 3 A.



SEER and SCOP: For S-6071PT3E + U-60PZ3E5A. INTERNET CONTROL: Optional.

Rating Conditions: Cooling Indoor 27 °C DB / 19 °C WB. Cooling Outdoor 35 °C DB / 24 °C WB. Heating Indoor 20 °C DB. Heating Outdoor 7 °C DB / 6 °C WB. (DB: Dry Bulb; WB: Wet Bulb). Specifications subject to change without notice. For detailed information about ErP / Energy Labelling, please visit our websites www.aircon.panasonic.eu or www.ptc.panasonic.eu.

NEW
2021

nanoe™ X as a standard.

NEW PACi NX Series Elite adaptive ducted unit Inverter+
• R32
New design duct range PF3.

2 installation possibilities (horizontal / vertical) with high ESP 150Pa allows flexible installation.



		Single phase							
			3,6 kW	5,0 kW	6,0 kW	7,1 kW	10,0 kW	12,5 kW	14,0 kW
Kit			KIT-36PFH3Z5	KIT-50PFH3Z5	KIT-60PFH3Z5	KIT-71PFH3Z5	KIT-100PFH3Z5	KIT-125PFH3Z5	KIT-140PFH3Z5
Remote controller			CZ-RTC5B	CZ-RTC5B	CZ-RTC5B	CZ-RTC5B	CZ-RTC5B	CZ-RTC5B	CZ-RTC5B
Cooling capacity	Nominal (Min - Max)	kW	3,6(1,2 - 4,0)	5,0(1,2 - 5,6)	5,7(1,2 - 6,3)	6,8(2,2 - 7,8)	9,5(3,1 - 11,4)	12,1(3,2 - 13,6)	13,4(3,3 - 15,3)
EER ¹⁾		W/W	4,24	3,42	3,68	3,74	4,17	3,58	3,38
SEER / η _{sc} ²⁾			6,8 A++	6,1 A++	7,1 A++	7,1 A++	7,4 A++	281,7 %	275,9 %
P _{design}		kW	3,6	5,0	5,7	6,8	9,5	12,1	13,4
Input power cooling		kW	0,850	1,46	1,55	1,82	2,28	3,38	3,96
Annual energy consumption ³⁾		kWh/a	185	287	281	332	447	—	—
Heating capacity	Nominal (Min - Max)	kW	4,0(1,2 - 5,0)	5,6(1,2 - 6,5)	7,0(1,2 - 8,0)	7,5(2,0 - 9,0)	10,8(3,1 - 13,5)	13,5(3,2 - 15,4)	15,5(3,3 - 17,4)
COP ¹⁾		W/W	4,17	3,61	3,74	4,03	3,97	3,46	3,44
SCOP / η _{sc} ²⁾			4,5 A+	4,2 A+	4,4 A+	4,7 A++	4,5 A+	170,0 %	171,0 %
P _{design} at -10 °C		kW	3,6	4,0	4,7	4,7	7,8	9,3	9,5
Input power heating		kW	0,96	1,55	1,87	1,86	2,72	3,90	4,51
Annual energy consumption ³⁾		kWh/a	1120	1333	1495	1393	2424	—	—
Indoor unit			S-3650PF3E	S-3650PF3E	S-6071PF3E	S-6071PF3E	S-1014PF3E	S-1014PF3E	S-1014PF3E
External static pressure ⁴⁾	Nominal (Min - Max)	Pa	30(10 - 150)	30(10 - 150)	30(10 - 150)	30(10 - 150)	40(10 - 150)	50(10 - 150)	50(10 - 150)
Air flow	Hi / Med / Lo	m ³ /min	14,0/13,0/10,0	16,0/15,0/12,0	21,0/19,0/15,0	21,0/19,0/15,0	32,0/26,0/21,0	34,0/29,0/23,0	36,0/32,0/25,0
Moisture removal volume		L/h	0,9	1,9	1,7	2,7	3,2	4,1	4,9
Sound pressure ⁵⁾	Hi / Med / Lo	dB(A)	30/27/22	34/30/25	30/26/23	30/26/23	33/29/25	35/31/27	39/35/29
Sound power	Hi / Med / Lo	dB(A)	53/50/45	57/53/48	53/49/46	53/49/46	56/52/48	58/54/50	62/58/52
Dimension	HxWxD	mm	250x800x730	250x800x730	250x1000x730	250x1000x730	250x1400x730	250x1400x730	250x1400x730
Net weight		kg	25	25	30	30	39	39	39
nanoe X Generator			Mark 2	Mark 2	Mark 2	Mark 2	Mark 2	Mark 2	Mark 2
Outdoor unit			U-36PZH3E5	U-50PZH3E5	U-60PZH3E5	U-71PZH3E5	U-100PZH3E5	U-125PZH3E5	U-140PZH3E5
Power source		V	220 - 230 - 240	220 - 230 - 240	220 - 230 - 240	220 - 230 - 240	220 - 230 - 240	220 - 230 - 240	220 - 230 - 240
Current	Cool	A	4,20 - 4,00 - 3,85	6,90 - 6,60 - 6,35	7,25 - 6,95 - 6,65	9,00 - 8,60 - 8,25	11,10 - 10,80 - 10,30	16,50 - 15,80 - 15,10	19,60 - 18,70 - 17,90
	Heat	A	4,70 - 4,50 - 4,30	7,35 - 7,00 - 6,75	8,65 - 8,30 - 7,95	9,00 - 8,60 - 8,35	13,30 - 12,70 - 12,20	19,10 - 18,20 - 17,50	22,00 - 21,10 - 20,20
Air flow	Cool / Heat	m ³ /min	34,1/36,4	42,0/42,0	42,0/42,0	61,0/60,0	118,0/108,0	125,0/112,0	129,0/116,0
Sound pressure	Cool / Heat (Hi)	dB(A)	43/44	46/48	47/50	48/50	52/52	53/53	54/54
Sound power	Cool / Heat (Hi)	dB(A)	62/64	64/67	65/69	65/67	69/69	70/70	71/71
Dimension	HxWxD	mm	695x875x320	695x875x320	695x875x320	996x940x340	1416x940x340	1416x940x340	1416x940x340
Net weight		kg	42	42	43	65	98	98	98
Pipe diameter	Liquid pipe	Inch (mm)	1/4(6,35)	1/4(6,35)	1/4(6,35) ⁶⁾	3/8(9,52)	3/8(9,52)	3/8(9,52)	3/8(9,52)
	Gas pipe	Inch (mm)	1/2(12,70)	1/2(12,70)	1/2(12,70) ⁷⁾	5/8(15,88)	5/8(15,88)	5/8(15,88)	5/8(15,88)
Pipe length range		m	3 - 40	3 - 40	3 - 40	5 - 50	5 - 85	5 - 85	5 - 85
Elevation difference (in/out) ⁸⁾		m	15/30 ⁸⁾	15/30 ⁸⁾	15/30 ⁹⁾	15/30 ⁹⁾	15/30 ⁹⁾	15/30 ⁹⁾	15/30 ⁹⁾
Pipe length for additional gas		m	30	30	30	30	30	30	30
Additional gas amount		g/m	15	15	15	45	45	45	45
Refrigerant (R32) / CO ₂ , Eq.		kg / T	1,13/0,76	1,13/0,76	1,15/0,78	1,95/1,32	3,05/2,06	3,05/2,06	3,05/2,06
Operating range	Cool Min - Max	°C	-15 ~ +46	-15 ~ +46	-15 ~ +46	-15 ~ +48	-20 ~ +48 ¹⁰⁾	-20 ~ +48 ¹⁰⁾	-20 ~ +48 ¹⁰⁾
	Heat Min - Max	°C	-20 ~ +24	-20 ~ +24	-20 ~ +24	-20 ~ +24	-20 ~ +24	-20 ~ +24	-20 ~ +24

Technical focus

- 2 installation possibilities (horizontal / vertical)
- Maximum external static pressure: 150 Pa
- Selectable inlet air position (rear / bottom entry)
- Improved drain pan suitable for both horizontal / vertical installation
- Drain pump included
- nanoe™ X (Generator Mark 2= 9,6 trillion hydroxyl radicals/sec) as standard for the long duct piping case*
- Wired remote control CZ-RTC6BL allows easy system setting via Bluetooth®

* The performance of nanoe™ X air can be expected even by 10 m long duct by Panasonic internal survey.

2 installation possibilities (horizontal / vertical)

Vertical installation is newly available. ESP 150Pa, sufficient for remotely installing units away from the rooms.

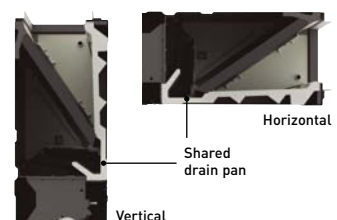

Improved drain pan design

Drain pan is shared in both cases horizontal and vertical installation. No need to alternate anymore.



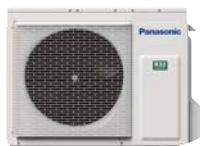

CZ-RTC5B



Optional controller.
CONEX wired remote controller.
CZ-RTC6 - CZ-RTC6BL
- CZ-RTC6BLW



Optional controller.
Infrared remote controller.
CZ-RWS3 +
CZ-RWRC3



Optional Econavi sensor.
CZ-CENSC1

COMPATIBLE WITH ALL PANASONIC CONNECTIVITY SOLUTIONS

			Three phase			
			7,1 kW	10,0 kW	12,5 kW	14,0 kW
			KIT-71PFH3Z8	KIT-100PFH3Z8	KIT-125PFH3Z8	KIT-140PFH3Z8
			CZ-RTC5B	CZ-RTC5B	CZ-RTC5B	CZ-RTC5B
Cooling capacity	Nominal (Min - Max)	kW	6,8[2,2 - 7,8]	9,5[3,1 - 11,4]	12,1[3,2 - 13,6]	13,4[3,3 - 15,3]
EER ¹⁾		W/W	3,74	4,17	3,58	3,38
SEER / η_{sc} ²⁾			7,0 A++	7,3 A++	281,7 %	275,9 %
Pdesign		kW	6,8	9,5	12,1	13,4
Input power cooling		kW	1,82	2,28	3,38	3,96
Annual energy consumption ³⁾		kWh/a	338	451	—	—
Heating capacity	Nominal (Min - Max)	kW	7,5[2,0 - 9,0]	10,8[3,1 - 13,5]	13,5[3,2 - 15,4]	15,5[3,3 - 17,4]
COP ¹⁾		W/W	4,03	3,97	3,46	3,44
SCOP / η_{sc} ²⁾			4,7 A++	4,5 A+	170,0 %	171,0 %
Pdesign at -10 °C		kW	4,7	7,8	9,3	9,5
Input power heating		kW	1,86	2,72	3,9	4,51
Annual energy consumption ³⁾		kWh/a	1394	2424	—	—
Indoor unit			S-6071PF3E	S-1014PF3E	S-1014PF3E	S-1014PF3E
External static pressure ⁴⁾	Nominal (Min - Max)	Pa	30(10 - 150)	40(10 - 150)	50(10 - 150)	50(10 - 150)
Air flow	Hi / Med / Lo	m ³ /min	21,0/19,0/15,0	32,0/26,0/21,0	34,0/29,0/23,0	36,0/32,0/25,0
Moisture removal volume		L/h	2,7	3,2	4,1	4,9
Sound pressure ⁵⁾	Hi / Med / Lo	dB(A)	30/26/23	33/29/25	35/31/27	39/35/29
Sound power	Hi / Med / Lo	dB(A)	53/49/46	56/52/48	58/54/50	62/58/52
Dimension	H x W x D	mm	250 x 1000 x 730	250 x 1400 x 730	250 x 1400 x 730	250 x 1400 x 730
Net weight		kg	30	39	39	39
nanoe X Generator			Mark 2	Mark 2	Mark 2	Mark 2
Outdoor unit			U-71PZH3E8	U-100PZH3E8	U-125PZH3E8	U-140PZH3E8
Power source		V	380 - 400 - 415	380 - 400 - 415	380 - 400 - 415	380 - 400 - 415
Current	Cool	A	3,00 - 2,90 - 2,80	3,80 - 3,60 - 3,50	5,60 - 5,30 - 5,15	6,60 - 6,30 - 6,05
	Heat	A	3,05 - 2,95 - 2,85	4,50 - 4,30 - 4,15	6,45 - 6,10 - 5,90	7,55 - 7,15 - 6,90
Air flow	Cool / Heat	m ³ /min	61,0/60,0	118,0/108,0	125,0/112,0	129,0/116,0
Sound pressure	Cool / Heat (Hi)	dB(A)	48/50	52/52	53/53	54/54
Sound power	Cool / Heat (Hi)	dB(A)	65/67	69/69	70/70	71/71
Dimension	H x W x D	mm	996 x 940 x 340	1416 x 940 x 340	1416 x 940 x 340	1416 x 940 x 340
Net weight		kg	65	98	98	98
Pipe diameter	Liquid pipe	Inch (mm)	3/8(9,52)	3/8(9,52)	3/8(9,52)	3/8(9,52)
	Gas pipe	Inch (mm)	5/8(15,88)	5/8(15,88)	5/8(15,88)	5/8(15,88)
Pipe length range		m	5 - 50	5 - 85	5 - 85	5 - 85
Elevation difference (in/out) ⁸⁾		m	15/30 ⁹⁾	15/30 ⁹⁾	15/30 ⁹⁾	15/30 ⁹⁾
Pipe length for additional gas		m	30	30	30	30
Additional gas amount		g/m	45	45	45	45
Refrigerant (R32) / CO ₂ Eq.		kg / T	1,95/1,32	3,05/2,06	3,05/2,06	3,05/2,06
Operating range	Cool Min ~ Max	°C	-15 ~ +48	-20 ~ +48 ¹⁰⁾	-20 ~ +48 ¹⁰⁾	-20 ~ +48 ¹⁰⁾
	Heat Min ~ Max	°C	-20 ~ +24	-20 ~ +24	-20 ~ +24	-20 ~ +24

Accessories

CZ-RTC6	CONEX wired remote controller (non-wireless)
CZ-RTC6BL	CONEX wired remote controller with Bluetooth®
CZ-RTC6BLW	CONEX wired remote controller with Wi-Fi and Bluetooth®
CZ-RTC5B	Wired remote controller with Econavi function and datanavi
CZ-RWS3 + CZ-RWRC3	Infrared remote controller
CZ-CAPWFC1	Commercial Wi-Fi Adaptor

Accessories

PAW-WTRAY	Tray for condenser water compatible with outdoor elevation platform
PAW-GRDBSE20	Outdoor base ground support for noise and vibration absorption
PAW-GRDSTD40	Outdoor elevation platform 400 x 900 x 400 mm
CZ-CENSC1	Econavi energy savings sensor
CZ-56DAF2	Air outlet plenum for S-3650PF3E
CZ-90DAF2	Air outlet plenum for S-6071PF3E
CZ-160DAF2	Air outlet plenum for S-1014PF3E

1) EER and COP calculation is based in accordance to EN14511. 2) For models below 12 kW, the SEER and SCOP is calculated based on values of EU/626/2011. For models above 12 kW, the η_{sc} / η_{sh} values is calculated based on EN 14825. 3) Factory setting. 4) Medium external static pressure setting from factory. 5) The sound pressure of the units shows the value measured of the position 1,5 m below the unit. The sound pressure is measured in accordance with Eurovent 6/C/006-97 specification. 6) Connect the liquid socket tube (Ø6,35-Ø9,52) to the liquid tubing side indoor unit. 7) Connect the gas socket tube (Ø12,70-Ø15,88) to the gas tubing side indoor unit. 8) When installing the outdoor unit at a higher position than the indoor unit. 9) Outdoor unit located lower / outdoor unit located higher. 10) For models 100 - 140PZH3E5(8), it is possible to operate the lowest -20 °C in the computer rooms with the piping length of 30 m or less. * Recommended fuse for the indoor 3 A. ** Above values are in the case of standard installation(horizontal installation in the ceiling, rear side air intake) and nanoe™ X OFF.

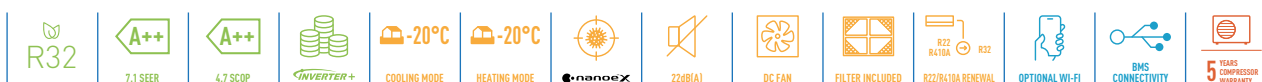

SEER and SCOP: For S-6071PF3E + U-71PZH3E5. SUPER QUIET: For S-3650PF3E + U-36PZH3E5. INTERNET CONTROL: Optional.

Rating Conditions: Cooling Indoor 27 °C DB / 19 °C WB. Cooling Outdoor 35 °C DB / 24 °C WB. Heating Indoor 20 °C DB. Heating Outdoor 7 °C DB / 6 °C WB. (DB: Dry Bulb; WB: Wet Bulb). Specifications subject to change without notice. For detailed information about ErP / Energy Labelling, please visit our websites www.aircon.panasonic.eu or www.ptc.panasonic.eu.

NEW
2021

nanoe™ X as a standard.

NEW PACi NX Series Standard adaptive ducted unit
Inverter+ • R32
New design duct range PF3.

2 installation possibilities (horizontal / vertical) with high ESP 150Pa allows flexible installation.



		Single phase							
Kit			3,6 kW	5,0 kW	6,0 kW	7,1 kW	10,0 kW	12,5 kW	14,0 kW
Remote controller			KIT-36PF3Z5	KIT-50PF3Z5	KIT-60PF3Z5	KIT-71PF3Z5	KIT-100PF3Z5	KIT-125PF3Z5	KIT-140PF3Z5
			CZ-RTC5B	CZ-RTC5B	CZ-RTC5B	CZ-RTC5B	CZ-RTC5B	CZ-RTC5B	CZ-RTC5B
Cooling capacity	Nominal (Min - Max)	kW	3,4(1,5 - 4,0)	5,0(1,5 - 5,3)	5,7(2,0 - 6,3)	6,8(2,6 - 7,7)	9,5(3,0 - 11,4)	12,1(3,2 - 13,5)	13,4(3,3 - 15,0)
EER ¹⁾	Nominal (Min - Max)	W/W	3,78	2,78	3,54	3,18	3,57(5,08 - 2,36)	3,40(5,08 - 2,76)	3,16(5,08 - 2,56)
SEER / η _{sc} ²⁾			6,0 A+	6,5 A++	6,4 A++	6,0 A+	6,6 A++	257,5 %	252,6 %
Pdesign		kW	3,4	5,0	5,7	6,8	9,5	12,1	13,4
Input power cooling	Nominal (Min - Max)	kW	0,9	1,8	1,61	2,14	2,66(0,59 - 4,84)	3,56(0,63 - 4,90)	4,24(0,65 - 5,86)
Annual energy consumption ³⁾		kWh/a	198	267	310	391	502	—	—
Heating capacity	Nominal (Min - Max)	kW	3,4(1,5 - 4,6)	5,0(1,5 - 5,9)	5,7(1,8 - 7,0)	6,8(2,1 - 8,1)	9,5(3,0 - 13,5)	12,1(3,3 - 15,0)	13,4(3,4 - 16,0)
COP ¹⁾	Nominal (Min - Max)	W/W	4,15	3,62	4,04	4,00	4,09(5,08 - 3,00)	3,56(5,24 - 3,16)	3,76(5,23 - 3,03)
SCOP / η _{sc} ²⁾			4,0 A+	4,0 A+	4,4 A+	4,1 A+	3,9 A	144,2 %	140,8 %
Pdesign at -10 °C		kW	2,4	3,8	4,4	4,7	7,8	9,3	9,5
Input power heating	Nominal (Min - Max)	kW	0,82	1,38	1,41	1,7	2,32(0,59 - 4,50)	3,40(0,63 - 4,74)	3,56(0,65 - 5,28)
Annual energy consumption ³⁾		kWh/a	839	1303	1376	1591	2795	—	—
Indoor unit			S-3650PF3E	S-3650PF3E	S-6071PF3E	S-6071PF3E	S-1014PF3E	S-1014PF3E	S-1014PF3E
External static pressure ⁴⁾	Nominal (Min - Max)	Pa	30(10 - 150)	30(10 - 150)	30(10 - 150)	30(10 - 150)	40(10 - 150)	50(10 - 150)	50(10 - 150)
Air flow	Hi / Med / Lo	m ³ /min	14,0/13,0/10,0	16,0/15,0/12,0	21,0/19,0/15,0	21,0/19,0/15,0	32,0/26,0/21,0	34,0/29,0/23,0	36,0/32,0/25,0
Moisture removal volume		L/h	0,9	1,9	1,7	2,7	3,2	4,1	4,9
Sound pressure ⁵⁾	Hi / Med / Lo	dB(A)	30/27/22	34/30/25	30/26/23	30/26/23	33/29/25	35/31/27	39/35/29
Sound power	Hi / Med / Lo	dB(A)	53/50/45	57/53/48	53/49/46	53/49/46	56/52/48	58/54/50	62/58/52
Dimension	HxWxD	mm	250x800x730	250x800x730	250x1000x730	250x1000x730	250x1400x730	250x1400x730	250x1400x730
Net weight		kg	25	25	30	30	39	39	39
nanoe X Generator			Mark 2	Mark 2	Mark 2	Mark 2	Mark 2	Mark 2	Mark 2
Outdoor unit			U-36PZ3E5	U-50PZ3E5	U-60PZ3E5A	U-71PZ3E5A	U-100PZ3E5	U-125PZ3E5	U-140PZ3E5
Power source		V	220 - 230 - 240	220 - 230 - 240	220 - 230 - 240	220 - 230 - 240	220 - 230 - 240	220 - 230 - 240	220 - 230 - 240
Current	Cool	A	4,15 - 4,00 - 3,85	8,35 - 8,00 - 7,65	7,45 - 7,15 - 6,85	9,95 - 9,50 - 9,10	13,30 - 12,70 - 12,20	17,20 - 16,40 - 15,80	20,50 - 19,60 - 18,8
	Heat	A	3,85 - 3,70 - 3,50	6,45 - 6,20 - 5,95	6,55 - 6,25 - 6,00	7,90 - 7,55 - 7,25	11,60 - 11,10 - 10,60	16,40 - 15,70 - 15,00	17,20 - 16,40 - 15,80
Air flow	Cool / Heat	m ³ /min	33,6/34,0	32,7/31,9	42,6/41,5	44,7/45,9	73,0/73,0	82,0/80,0	84,0/82,0
Sound pressure	Cool / Heat (Hi)	dB(A)	46/47	46/46	47/48	48/49	52/52	55/55	56/56
Sound power	Cool / Heat (Hi)	dB(A)	64/66	64/64	64/65	66/68	70/70	73/73	74/74
Dimension	HxWxD	mm	619x824x299	619x824x299	695x875x320	695x875x320	996x980x370	996x980x370	996x980x370
Net weight		kg	32	35	42	50	83	87	87
Pipe diameter	Liquid pipe	Inch (mm)	1/4(Ø6,35)	1/4(Ø6,35)	1/4(Ø6,35) ⁶⁾	1/4(Ø6,35) ⁶⁾	3/8(9,52)	3/8(9,52)	3/8(9,52)
	Gas pipe	Inch (mm)	1/2(Ø12,7)	1/2(Ø12,7)	1/2(Ø12,7) ⁷⁾	5/8(Ø15,88)	5/8(15,88)	5/8(15,88)	5/8(15,88)
Pipe length range		m	3 - 15	3 - 20	3 - 40	3 - 40	5 - 50	5 - 50	5 - 50
Elevation difference (in/out) ⁸⁾		m	15/15 ⁹⁾	15/15 ⁹⁾	15/30 ⁹⁾	20/30 ⁹⁾	15/30 ⁹⁾	15/30 ⁹⁾	15/30 ⁹⁾
Pipe length for additional gas		m	7,5	7,5	30	30	30	30	30
Additional gas amount		g/m	10	15	15	17	45	45	45
Refrigerant (R32) / CO ₂ Eq.		kg / T	0,87/0,59	1,14/0,77	1,15/0,78	1,32/0,89	2,40/1,62	2,80/1,89	2,80/1,89
Operating range	Cool Min - Max	°C	-10 ~ +43	-10 ~ +43	-10 ~ +43	-10 ~ +43	-10 ~ +43	-10 ~ +43	-10 ~ +43
	Heat Min - Max	°C	-15 ~ +24	-15 ~ +24	-15 ~ +24	-15 ~ +24	-15 ~ +24	-15 ~ +24	-15 ~ +24

Technical focus

- 2 installation possibilities (horizontal / vertical)
- Maximum external static pressure: 150 Pa
- Selectable inlet air position (rear / bottom entry)
- Improved drain pan suitable for both horizontal / vertical installation
- Drain pump included
- nanoe™ X (Generator Mark 2= 9,6 trillion hydroxyl radicals/sec) as standard for the long duct piping case*
- Wired remote control CZ-RTC6BL allows easy system setting via Bluetooth®

* The performance of nanoe™ X air can be expected even by 10 m long duct by Panasonic internal survey.

2 installation possibilities (horizontal / vertical)

Vertical installation is newly available. ESP 150Pa, sufficient for remotely installing units away from the rooms.

Improved drain pan design

Drain pan is shared in both cases horizontal and vertical installation. No need to alternate anymore.

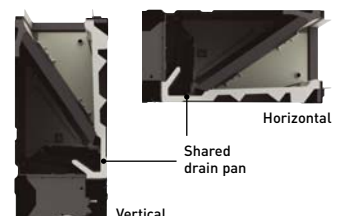



CZ-RTC5B



CONEX



Optional controller.
CONEX wired remote
controller.
CZ-RTC6 - CZ-RTC6BL
- CZ-RTC6BLW



Optional controller.
Infrared remote
controller.
CZ-RWS3 +
CZ-RWRC3

Optional Econavi
sensor.
CZ-CENSC1

			Three phase		
			10,0 kW	12,5 kW	14,0 kW
Kit			KIT-100PF3Z8	KIT-125PF3Z8	KIT-140PF3Z8
Remote controller			CZ-RTC5B	CZ-RTC5B	CZ-RTC5B
Cooling capacity	Nominal (Min - Max)	kW	9,5(3,0 - 11,4)	12,1(3,2 - 13,5)	13,4(3,3 - 15,0)
EER ¹⁾	Nominal (Min - Max)	W/W	3,57(5,08 - 2,36)	3,40(5,08 - 2,76)	3,16(5,08 - 2,56)
SEER / η _{sc} ²⁾			6,6 A++	256,5 %	251,7 %
P _{design}		kW	9,5	12,1	13,4
Input power cooling	Nominal (Min - Max)	kW	2,66(0,59 - 4,84)	3,56(0,63 - 4,90)	4,24(0,65 - 5,86)
Annual energy consumption ³⁾		kWh/a	502	—	—
Heating capacity	Nominal (Min - Max)	kW	9,5(3,0 - 13,5)	12,1(3,3 - 15,0)	13,4(3,4 - 16,0)
COP ¹⁾	Nominal (Min - Max)	W/W	4,09(5,08 - 3,00)	3,56(5,24 - 3,16)	3,76(5,23 - 3,03)
SCOP / η _{sc} ²⁾			3,9 A	144,1 %	140,8 %
P _{design} at -10 °C		kW	7,8	9,3	9,5
Input power heating	Nominal (Min - Max)	kW	2,32(0,59 - 4,50)	3,40(0,63 - 4,74)	3,56(0,65 - 5,28)
Annual energy consumption ³⁾		kWh/a	2795	—	—
Indoor unit			S-1014PF3E	S-1014PF3E	S-1014PF3E
External static pressure ⁴⁾	Nominal (Min - Max)	Pa	40(10 - 150)	50(10 - 150)	50(10 - 150)
Air flow	Hi / Med / Lo	m ³ /min	32,0/26,0/21,0	34,0/29,0/23,0	36,0/32,0/25,0
Moisture removal volume		L/h	3,2	4,1	4,9
Sound pressure ⁵⁾	Hi / Med / Lo	dB(A)	33/29/25	35/31/27	39/35/29
Sound power	Hi / Med / Lo	dB(A)	56/52/48	58/54/50	62/58/52
Dimension	H x W x D	mm	250 x 1400 x 730	250 x 1400 x 730	250 x 1400 x 730
Net weight		kg	39	39	39
nanoe™ X Generator			Mark 2	Mark 2	Mark 2
Outdoor unit			U-100PZ3E8	U-125PZ3E8	U-140PZ3E8
Power source		V	380 - 400 - 415	380 - 400 - 415	380 - 400 - 415
Current	Cool	A	4,45 - 4,20 - 4,05	5,75 - 5,45 - 5,25	6,85 - 6,50 - 6,30
	Heat	A	3,85 - 3,70 - 3,55	5,50 - 5,20 - 5,05	5,75 - 5,45 - 5,25
Air flow	Cool / Heat	m ³ /min	73,0/73,0	82,0/80,0	84,0/82,0
Sound pressure	Cool / Heat (Hi)	dB(A)	52/52	55/55	56/56
Sound power	Cool / Heat (Hi)	dB(A)	70/70	73/73	74/74
Dimension	H x W x D	mm	996 x 980 x 370	996 x 980 x 370	996 x 980 x 370
Net weight		kg	83	87	87
Pipe diameter	Liquid pipe	Inch (mm)	3/8(9,52)	3/8(9,52)	3/8(9,52)
	Gas pipe	Inch (mm)	5/8(15,88)	5/8(15,88)	5/8(15,88)
Pipe length range		m	5 - 50	5 - 50	5 - 50
Elevation difference (in/out) ⁸⁾		m	15/30 ⁹⁾	15/30 ⁹⁾	15/30 ⁹⁾
Pipe length for additional gas		m	30	30	30
Additional gas amount		g/m	45	45	45
Refrigerant (R32) / CO ₂ Eq.		kg / T	2,40/1,62	2,80/1,89	2,80/1,89
Operating range	Cool Min ~ Max	°C	-10 ~ +43	-10 ~ +43	-10 ~ +43
	Heat Min ~ Max	°C	-15 ~ +24	-15 ~ +24	-15 ~ +24

Accessories

CZ-RTC6	CONEX wired remote controller (non-wireless)
CZ-RTC6BL	CONEX wired remote controller with Bluetooth®
CZ-RTC6BLW	CONEX wired remote controller with Wi-Fi and Bluetooth®
CZ-RTC5B	Wired remote controller with Econavi function and datanavi
CZ-RWS3 + CZ-RWRC3	Infrared remote controller
CZ-CAPWFC1	Commercial Wi-Fi Adaptor

Accessories

PAW-WTRAY	Tray for condenser water compatible with outdoor elevation platform
PAW-GRDBSE20	Outdoor base ground support for noise and vibration absorption
PAW-GRDSTD40	Outdoor elevation platform 400x900x400 mm
CZ-CENSC1	Econavi energy savings sensor
CZ-56DAF2	Air outlet plenum for S-3650PF3E
CZ-90DAF2	Air outlet plenum for S-6071PF3E
CZ-160DAF2	Air outlet plenum for S-1014PF3E

1) EER and COP calculation is based in accordance to EN14511. 2) For models below 12 kW, the SEER and SCOP is calculated based on values of EU/626/2011. For models above 12 kW, the η_{sc} / η_{sh} values is calculated based on EN 14825. 3) Factory setting. 4) Medium external static pressure setting from factory. 5) The sound pressure of the units shows the value measured of the position 1,5 m below the unit. The sound pressure is measured in accordance with Eurovent 6/C/006-97 specification. 6) Connect the liquid socket tube (Ø6,35-Ø9,52) to the liquid tubing side indoor unit. 7) Connect the gas socket tube (Ø12,70-Ø15,88) to the gas tubing side indoor unit. 8) When installing the outdoor unit at a higher position than the indoor unit. 9) Outdoor unit located lower / outdoor unit located higher. * Recommended fuse for the indoor 3 A. ** Above values are in the case of standard installation(horizontal installation in the ceiling, rear side air intake) and nanoe™ X OFF.



SEER: For S-1014PF3E + U-100PZ3E5. SCOP: For S-6071PF3E + U-60PZ3E5A. SUPER QUIET: For S-3650PF3E + U-36PZ3E5. INTERNET CONTROL: Optional.

Rating Conditions: Cooling Indoor 27 °C DB / 19 °C WB. Cooling Outdoor 35 °C DB / 24 °C WB. Heating Indoor 20 °C DB. Heating Outdoor 7 °C DB / 6 °C WB. (DB: Dry Bulb; WB: Wet Bulb). Specifications subject to change without notice. For detailed information about ErP / Energy Labelling, please visit our websites www.aircon.panasonic.eu or www.ptc.panasonic.eu.



Panasonic Big PACi high static pressure hide-away 20,0-25,0 kW Inverter+ • R32

Panasonic Big PACi, not only environmental friendly but also a groundbreaking product.

Big PACi with R32 has been introduced with full renewal of its indoor unit, offering hydronic application by PACi Water heat exchanger.

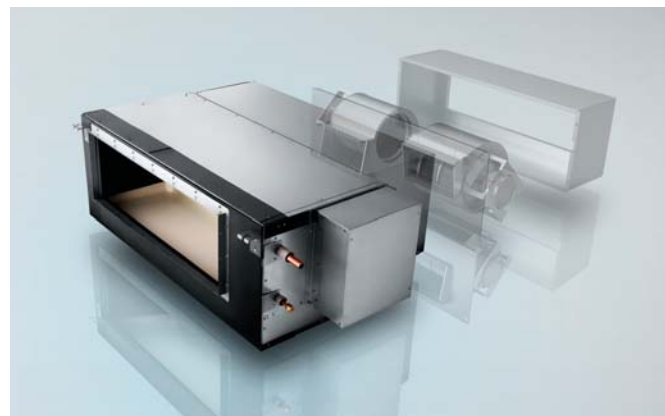

1 Compact & light indoor body
Compact and light indoor body, keeping the high efficiency, has a split-able design for easy installation within a limited narrow space. Plus ease of maintenance due to the simplified disassembly design.

2 Easy pipe work with split-able hide-away indoor design
Heat exchanger and fan elements (fan + casing) can be separated during installation. The hide-away indoor unit is easily reassembled and will fit through a narrow space.

3 High external static pressure, maximum 200 Pa* setting
A high static pressure enables the use of long ducts for installation in a wide range of spaces.

* S-250PE3E5B.

4 Panasonic Comfort Cloud App control
Ready to control PACi systems with Panasonic Comfort Cloud App in your smartphones.*

* Panasonic Wi-Fi Adaptor CZ-CAPWFC1 is required.

Compact and light indoor body, keeping high efficiency

15 % lighter weight vs conventional model drastically improves installation work.

	Conventional model	Panasonic model
20,0 kW	100 kg	86 kg
25,0 kW	104 kg	88 kg

DEPTH WAS REDUCED BY 230 mm



Maximum 200 Pa* static pressure setting

A high static pressure enables the use of long ducts for installation in a wide range of spaces.

3-step static pressure set up.
Selectable of static pressure modes can change 200 Pa / 130 Pa / 75 Pa for extra installation flexibility.

* In case of S-250PE3E5B.



Easy Installation with Light Components

Indoor unit can easily be split into 3 components, the heaviest of which weighs only 48 kg.



Dimensions of Each Component (lightweight design for easy disassembly).



The weight is for S-200PE3E5B model.



CZ-RTC5B

COMPATIBLE WITH ALL PANASONIC CONNECTIVITY SOLUTIONS

CONEX



Optional controller.
CONEX wired remote controller.
CZ-RTC6 - CZ-RTC6BL



Optional controller.
Infrared remote controller.
CZ-RWS3 + CZ-RWRC3



Optional Econavi sensor.
CZ-CENSC1

Three phase

			20,0 kW	25,0 kW
			KIT-200PE3ZH8	KIT-250PE3ZH8
			CZ-RTC5B	CZ-RTC5B
Kit				
Remote controller				
Cooling capacity	Nominal (Min - Max)	kW	19,5 [5,7 - 21,0]	23,2 [6,1 - 27,0]
EER ¹⁾		W/W	3,22	3,11
SEER / η_{sc} ²⁾			207,0 %	190,6 %
P _{design}		kW	19,5	23,2
Input power cooling		kW	6,06	7,46
Heating capacity	Nominal (Min - Max)	kW	22,4 [5,0 - 25,0]	28,0 [5,5 - 29,0]
COP ¹⁾		W/W	3,61	3,41
SCOP / η_{sc} ²⁾			141,3 %	142,7 %
P _{design} at -10 °C		kW	17,0	20,0
Input power heating		kW	6,21	8,21
Indoor unit			S-200PE3E5B	S-250PE3E5B
Power source		V / ph / Hz	220 - 230 - 240 / 1 / 50	220 - 230 - 240 / 1 / 50
External static pressure at shipment (adjustable)		Pa	75 ³⁾ - 120 - 180	75 ³⁾ - 130 - 200
Air flow	Hi / Med / Lo	m ³ /min	72 / 63 / 53	84 / 72 / 59
Sound pressure ⁴⁾	Hi / Med / Lo	dB(A)	46 / 44 / 41	47 / 45 / 42
Dimension	H x W x D	mm	486 x 1456 x 916	486 x 1456 x 916
Net weight		kg	86	88
Outdoor unit			U-200PZH2E8	U-250PZH2E8
Power source		V / ph / Hz	380 - 400 - 415 / 3 / 50	380 - 400 - 415 / 3 / 50
Recommended fuse		A	30	30
Air flow	Cool / Heat	m ³ /min	164 / 164	160 / 160
Sound pressure	Cool / Heat (Hi)	dB(A)	59 / 61	59 / 63
Sound power	Cool / Heat (Hi)	dB(A)	77 / 79	78 / 82
Dimension ⁵⁾	H x W x D	mm	1500 x 980 x 370	1500 x 980 x 370
Net weight		kg	117	128
Pipe diameter	Liquid pipe	Inch (mm)	3/8 (9,52)	1/2 (12,70)
	Gas pipe	Inch (mm)	1 (25,40)	1 (25,40)
Pipe length range		m	5 - 90	5 - 60
Elevation difference (in/out) ⁶⁾		m	30	30
Pipe length for additional gas		m	30	30
Additional gas amount		g/m	60	80
Refrigerant (R32) / CO ₂ Eq.		kg / T	4,20 / 2,835	5,20 / 3,51
Operating range	Cool Min ~ Max	°C	-15 ~ +46	-15 ~ +46
	Heat Min ~ Max	°C	-20 ~ +24	-20 ~ +24

Accessories

CZ-RTC6	CONEX wired remote controller (non-wireless)
CZ-RTC6BL	CONEX wired remote controller with Bluetooth®
CZ-RTC5B	Wired remote controller with Econavi function and datanavi
CZ-RWS3 + CZ-RWRC3	Infrared remote controller

Accessories

CZ-CAPWFC1	Commercial Wi-Fi Adaptor
PAW-GRDBSE20	Outdoor base ground support for noise and vibration absorption
PAW-GRDSTD40	Outdoor elevation platform 400x900x400 mm
CZ-CENSC1	Econavi energy savings sensor

1) EER and COP calculation is based in accordance to EN14511. 2) For models below 12 kW, the SEER and SCOP is calculated based on values of EU/626/2011. For models above 12 kW, the η_{sc} / η_{sh} values is calculated based on EN 14825. 3) Factory setting. 4) The sound pressure of the units shows the value measured of the position 1,5 m below the unit. The sound pressure is measured in accordance with Eurovent 6/C/006-97 specification. 5) Add 100 mm for indoor unit or 70 mm for outdoor unit for piping port. 6) When installing the outdoor unit at a higher position than the indoor unit. * No filter included.



INTERNET CONTROL: Optional.

Rating Conditions: Cooling Indoor 27 °C DB / 19 °C WB. Cooling Outdoor 35 °C DB / 24 °C WB. Heating Indoor 20 °C DB. Heating Outdoor 7 °C DB / 6 °C WB. (DB: Dry Bulb; WB: Wet Bulb). Specifications subject to change without notice. For detailed information about ErP / Energy Labelling, please visit our websites www.aircon.panasonic.eu or www.ptc.panasonic.eu.

PACi NX single, twin, triple and double-twin systems • R32

NEW
2021

NEW PACi NX Elite Outdoor units • R32

			7,1 kW	10,0 kW	12,5 kW	14,0 kW	20,0 kW	25,0 kW
Outdoor unit single phase			U-71PZH3E5	U-100PZH3E5	U-125PZH3E5	U-140PZH3E5	—	—
Outdoor unit three phase			U-71PZH3E8	U-100PZH3E8	U-125PZH3E8	U-140PZH3E8	U-200PZH2E8	U-250PZH2E8
Cooling capacity	Nominal (Min - Max)	kW	6,8(2,2 - 9,0)	9,5(3,1 - 12,5)	12,1(3,2 - 14,0)	13,4(3,3 - 16,0)	20,0(5,7 - 22,4)	25,0(6,1 - 28,0)
Heating capacity	Nominal (Min - Max)	kW	8,0(2,0 - 9,0)	11,2(3,1 - 14,0)	14,0(3,2 - 16,0)	16,0(3,3 - 18,0)	22,4(5,0 - 25,0)	28,0(5,5 - 31,5)
Power source	Single phase	V	220 - 230 - 240	220 - 230 - 240	220 - 230 - 240	220 - 230 - 240	—	—
	Three phase	V	380 - 400 - 415	380 - 400 - 415	380 - 400 - 415	380 - 400 - 415	380 - 400 - 415	380 - 400 - 415
Connection indoor / outdoor		mm ²	2x1,5 or 2,5	2x1,5 or 2,5	2x1,5 or 2,5	2x1,5 or 2,5	—	—
Air flow	Cool / Heat	m ³ /min	61,0/60,0	118,0/108,0	125,0/112,0	129,0/116,0	164/164	160/160
Sound pressure	Cool / Heat (Hi)	dB(A)	48/50	52/52	53/53	54/54	59/61	59/63
Sound power	Cool / Heat (Hi)	dB(A)	65/67	69/69	70/70	71/71	77/79	78/82
Dimension	H x W x D	mm	996 x 940 x 340	1416 x 940 x 340	1416 x 940 x 340	1416 x 940 x 340	1500 x 980 x 370	1500 x 980 x 370
Net weight		kg	65	98	98	98	117	128
Pipe diameter	Liquid pipe	Inch (mm)	3/8 (9,52)	3/8 (9,52)	3/8 (9,52)	3/8 (9,52)	3/8 (9,52)	1/2 (12,70)
	Gas pipe	Inch (mm)	5/8 (15,88)	5/8 (15,88)	5/8 (15,88)	5/8 (15,88)	1 (25,40)	1 (25,40)
Pipe length range	Min ~ Max	m	5 ~ 50	5 ~ 85	5 ~ 85	5 ~ 85	5 ~ 80	5 ~ 60
Elevation difference (in/out)	Max	m	15/30 ¹⁾	15/30 ¹⁾	15/30 ¹⁾	15/30 ¹⁾	30	30
Pipe length for additional gas		m	30	30	30	30	30	30
Additional gas amount		g/m	45	45	45	45	60	80
Refrigerant (R32) / CO ₂ Eq.		kg / T	1,95/1,32	3,05/2,06	3,05/2,06	3,05/2,06	4,20/2,835	5,20/3,51
Operating range	Cool Min ~ Max	°C	-15 ~ -48	-20 ~ +48 ²⁾	-20 ~ +48 ²⁾	-20 ~ +48 ²⁾	-15 ~ +46	-15 ~ +46
	Heat Min ~ Max	°C	-20 ~ -24	-20 ~ -24	-20 ~ -24	-20 ~ -24	-20 ~ +24	-20 ~ +24

1) Outdoor unit located lower / outdoor unit located higher. 2) For models 100 ~ 140PZH3E5(8), it is possible to operate the lowest -20 °C in the computer rooms with the piping length of 30 m or less.

NEW
2021

NEW PACi NX Standard Outdoor units • R32

			10,0 kW	12,5 kW	14,0 kW
Outdoor unit single phase			U-100PZ3E5	U-125PZ3E5	U-140PZ3E5
Outdoor unit three phase			U-100PZ3E8	U-125PZ3E8	U-140PZ3E8
Cooling capacity	Nominal (Min - Max)	kW	10,0(3,0 - 11,5)	12,5(3,2 - 13,5)	14,0(3,3 - 15,0)
Heating capacity	Nominal (Min - Max)	kW	10,0(3,0 - 14,0)	12,5(3,3 - 15,0)	14,0(3,4 - 16,0)
Power source	Single phase	V	220-230-240	220-230-240	220-230-240
	Three phase	V	380-400-415	380-400-415	380-400-415
Connection indoor / outdoor		mm ²	2x1,5 or 2,5	2x1,5 or 2,5	2x1,5 or 2,5
Air flow	Cool / Heat	m ³ /min	73,0/73,0	82,0/80,0	84,0/82,0
Sound pressure	Cool / Heat (Hi)	dB(A)	52/52	55/55	56/56
Sound power	Cool / Heat (Hi)	dB(A)	70/70	73/73	74/74
Dimension	H x W x D	mm	996 x 980 x 370	996 x 980 x 370	996 x 980 x 370
Net weight		kg	83	87	87
Pipe diameter	Liquid pipe	Inch (mm)	3/8 (9,52)	3/8 (9,52)	3/8 (9,52)
	Gas pipe	Inch (mm)	5/8 (15,88)	5/8 (15,88)	5/8 (15,88)
Pipe length range	Min ~ Max	m	5 ~ 50	5 ~ 50	5 ~ 50
Elevation difference (in/out)	Max	m	15/30 ¹⁾	15/30 ¹⁾	15/30 ¹⁾
Pipe length for additional gas		m	30	30	30
Additional gas amount		g/m	45	45	45
Refrigerant (R32) / CO ₂ Eq.		kg / T	2,4/1,62	2,8/1,89	2,8/1,89
Operating range	Cool Min ~ Max	°C	+10 ~ +43	+10 ~ +43	+10 ~ +43
	Heat Min ~ Max	°C	-15 ~ -24	-15 ~ -24	-15 ~ -24

1) Outdoor unit located lower / outdoor unit located higher.

NEW
2021

NEW wall-mounted	Indoor	Cooling capacity	Heating capacity	Dimension	Sound pressure	Air flow
		kW	kW	H x W x D mm	Hi / Med / Lo dB(A)	Hi / Med / Lo m ³ /min
3,6 / 4,5 / 5,0 kW	S-3650PK3E	3,6 - 5,0	4,0 - 5,6	302 x 1120 x 236	35/31/27 ¹⁾	13,0/11,0/9,0 ¹⁾
6,0 / 7,1 kW	S-6010PK3E	6,1 - 10,0	7,0 - 8,0	302 x 1120 x 236	47/44/40 ¹⁾	20,0/17,5/14,5 ¹⁾

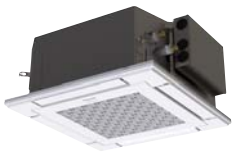
NEW
2021

NEW 4 way 60x60 cassette ²⁾	Indoor (panel CZ-KPY4)	Cooling capacity	Heating capacity	Dimension indoor	Dimension panel	Sound pressure	Air flow
		kW	kW	H x W x D mm	H x W x D mm	Hi / Med / Lo dB(A)	Hi / Med / Lo m ³ /min
3,6 kW	S-25PY3E						
4,5 kW	S-36PY3E						
5,0 kW	S-50PY3E						
6,0 kW	S-60PY3E						

Tentative data

NEW
2021

NEW 4 way 90x90 cassette	Indoor (panels CZ-KPU3W / CZ-KPU3AW)	Cooling capacity	Heating capacity	Dimension indoor	Dimension panel	Sound pressure	Air flow
		kW	kW	H x W x D mm	H x W x D mm	Hi / Med / Lo dB(A)	Hi / Med / Lo m ³ /min
3,6 / 4,5 / 5,0 kW	S-3650PU3E	3,6 - 5,0	4,0 - 5,6	256 x 840 x 840	33,5 x 950 x 950	30/28/27 ¹⁾	14,5/13,0/11,5 ¹⁾
6,0 / 7,1 kW	S-6071PU3E	6,0 - 7,1	7,0 - 8,0	256 x 840 x 840	33,5 x 950 x 950	36/31/28 ¹⁾	21,0/16,0/13,0 ¹⁾
10,0 / 12,5 / 14,0 kW	S-1014PU3E	10,0 - 14,0	11,2 - 16,0	319 x 840 x 840	33,5 x 950 x 950	45/38/32 ¹⁾	36,0/26,0/18,0 ¹⁾

NEW
2021

NEW ceiling	Indoor	Cooling capacity	Heating capacity	Dimension	Sound pressure	Air flow
		kW	kW	H x W x D mm	Hi / Med / Lo dB(A)	Hi / Med / Lo m ³ /min
3,6 / 4,5 / 5,0 kW	S-3650PT3E	3,5 - 5,0	4,0 - 5,6	235 x 960 x 690	36/32/28 ¹⁾	14,0/12,0/10,5 ¹⁾
6,0 / 7,1 kW	S-6071PT3E	6,0 - 6,8	7,0 - 8,0	235 x 1275 x 690	38/34/29 ¹⁾	20,0/17,0/14,5 ¹⁾
10,0 / 12,5 / 14,0 kW	S-1014PT3E	9,5 - 13,4	11,2 - 16,0	235 x 1590 x 690	42/37/34 ¹⁾	30,0/25,0/23,0 ¹⁾

NEW
2021

NEW adaptive ducted unit	Indoor	Cooling capacity	Heating capacity	Dimension	External static pressure	Sound pressure	Air flow
		kW	kW	H x W x D mm	Nominal (Min - Max) Pa	Hi / Med / Lo dB(A)	Hi / Med / Lo m ³ /min
3,6 / 4,5 / 5,0 kW	S-3650PF3E	3,6 - 5,0	4,0 - 5,6	250 x 800 x 730	30 (10 - 150)	30/27/22 ¹⁾	14,0/13,0/10,0 ¹⁾
6,0 / 7,1 kW	S-6071PF3E	5,7 - 6,8	7,0 - 7,5	250 x 1000 x 730	30 (10 - 150)	30/26/23 ¹⁾	21,0/19,0/15,0 ¹⁾
10,0 / 12,5 / 14,0 kW	S-1014PF3E	9,5 - 13,4	10,8 - 13,5	250 x 1400 x 730	30 (10 - 150)	33/29/25 ¹⁾	32,0/26,0/21,0 ¹⁾

1) 36/60/10 types of indoor units value. 2) Available in Autumn 2021.

Rating Conditions: Cooling Indoor 27 °C DB / 19 °C WB. Cooling Outdoor 35 °C DB / 24 °C WB. Heating Indoor 20 °C DB. Heating Outdoor 7 °C DB / 6 °C WB. (DB: Dry Bulb; WB: Wet Bulb). Specifications subject to change without notice. For detailed information about ErP / Energy Labelling, please visit our websites www.aircon.panasonic.eu or www.ptc.panasonic.eu.

PACi NX single, twin, triple and double-twin systems • R32

PACi NX Elite from 7,1 to 14,0 kW Single/Simultaneous operation system combinations • R32

Indoor	Outdoor			
	7,1 kW	10,0 kW	12,5 kW	14,0 kW
3,6 kW	Twin U-71 S-36 S-36	Triple U-100 S-36 S-36 S-36	Double-twin U-125 S-36 S-36 S-36 S-36	
4,5 kW			Triple U-125 S-45 S-45 S-45	
5,0 kW		Twin U-100 S-50 S-50		Triple U-140 S-50 S-50 S-50
6,0 kW			Twin	
7,1 kW	Single ²⁾ U-71 S-71			Twin U-140 S-71 S-71
10,0 kW		Single ²⁾ U-100 S-100		
12,5 kW			Single ²⁾ U-125 S-125	
14,0 kW				Single ²⁾ U-140 S-140

PACi NX Standard from 7,1 to 14,0 kW Single/Simultaneous operation system combinations • R32

Indoor	Outdoor			
	7,1 kW	10,0 kW	12,5 kW	14,0 kW
3,6 kW				
5,0 kW		Twin U-100 S-50 S-50		
6,0 kW			Twin U-125 S-60 S-60	
7,1 kW	Single ²⁾ U-71 S-71			Twin U-140 S-71 S-71
10,0 kW		Single ²⁾ U-100 S-100		
12,5 kW			Single ²⁾ U-125 S-125	
14,0 kW				Single ²⁾ U-140 S-140

PACi Elite from 20,0 to 25,0 kW Single/Simultaneous operation system combinations • R32

Indoor	Outdoor	
	20,0 kW	25,0 kW
5,0 kW	Double-twin U-200 S-50 S-50 S-50 S-50	
6,0 kW		Double-twin U-250 S-60 S-60 S-60 S-60
7,1 kW	Triple U-200 S-71 S-71 S-71	
10,0 kW	Twin U-200 S-100 S-100	
12,5 kW		Twin U-250 S-125 S-125
20,0 kW	Single ²⁾ U-200 S-200	
25,0 kW		Single ²⁾ U-250 S-250

1) Available for only PZ2 (R32) model with limitations of main pipe and branch pipe. Please contact an authorized Panasonic dealer. 2) PACi 1x1 Kit solution.

Single

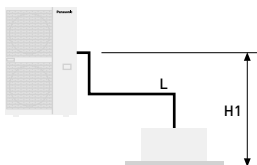

Twin

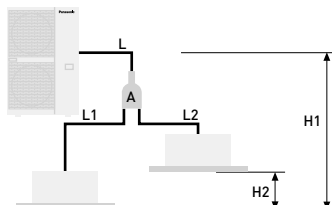

Triple

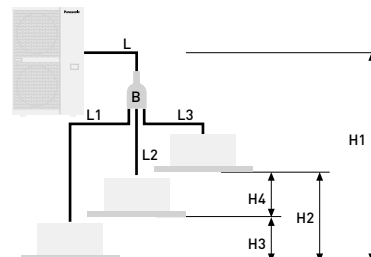

Double-twin

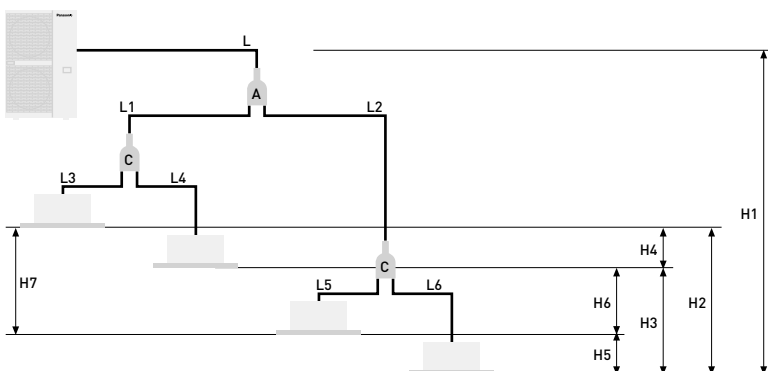

PACi Elite twin, triple and double-twin system from 7,1 to 14,0 kW

Joint distribution (sold separately)

A= CZ-P224BK2BM

B= CZ-P3 HPC2BM

C= CZ-P224BK2BM

PACi Standard twin system from 10,0 to 14,0 kW

Joint distribution (sold separately)

A= CZ-P224BK2BM

PACi Elite twin, triple and double-twin system from 20,0 to 25,0 kW

Joint distribution (sold separately)

A= CZ-P680BK2BM

B= CZ-P3 HPC2BM

C= CZ-P224BK2BM

Twin System	PACi Standard single and twin system from 7,1 to 14,0 kW		PACi Elite twin, triple and double-twin system from 7,1 to 25 kW					
	Indoor unit combinations (see examples above)		Indoor unit combinations (see examples above)		Equivalent lengths and height differences (m) for outdoor unit sizes from 7,1 to 14,0 kW	Equivalent lengths and height differences (m) for outdoor unit sizes from 20,0 to 25,0 kW		
	Single	Twin	Single	Twin			Triple	Double-Twin
Total pipe length	L	L + L1 + L2	L	L + L1 + L2	L + L1 + L2 + L3	L + L1 + L2 + L3 + L4 + L5 + L6	U-60/U-71: ≤ 50 m U-100/125/140: ≤ 75 m	U-200: ≤ 100 m U-250: ≤ 80 m
Maximum pipe length from outdoor unit to most distant indoor unit	-	-	-	L + L1 or L + L2	L + L1 or L + L2 or L + L3	L + L1 + L3 or L + L1 + L4 or L + L2 + L5 or L + L2 + L6	-	U-200: 90 m U-250: 60 m
Maximum branch pipe length	-	L1 L2	-	L1 or L2	L1 or L2 or L3	L1 + L3 or L1 + L4 or L2 + L5 or L2 + L6	≤ 15 m	≤ 20 m
Maximum branch pipe length differences	-	L1 > L2 L1 - L2	-	L1 > L2; L1 - L2	L1 > L2 > L3; L1 - L2 L2 - L3 L1 - L3	L2 + L6 (Max.) L1 + L3 (Min.); (L2 + L6) - (L1 + L3)	≤ 10 m	≤ 10 m
Maximum pipe length differences after first branch (Double-Twin)	-	-	-	-	-	L2 > L1; L2 - L1	≤ 10 m	≤ 10 m
Maximum pipe length differences after second branch (Double-Twin)	-	-	-	-	-	L4 > L3; L4 - L3 L6 > L5; L6 - L5	≤ 10 m	≤ 10 m
Height difference (outdoor unit located higher)	H1	H1	H1	H1	H1	H1	≤ 30 m	≤ 30 m
Height difference (outdoor unit located lower)	H1	H1	H1	H1	H1	H1	≤ 15 m	≤ 15 m
Height difference between indoor units	-	H2	-	H2	H2 or H3 or H4	H2 or H3 or H4 or H5 or H6	≤ 0,5 m	≤ 0,5 m

Twin System	PACi Standard single and twin system from 7,1 to 14,0 kW				PACi Elite twin, triple and double-twin system from 7,1 to 14,0 kW						PACi Elite twin, triple and double-twin system from 20,0 to 25,0 kW				
	Outdoor unit main pipe diameter (L)		Indoor unit connection tube (L1, L2)		Outdoor unit main pipe diameter (L)	Indoor unit connection pipe diameter (L1, L2, L3, L4) (mm)					Outdoor unit main pipe diameter (L) (mm)	Double-Twin distribution pipe (L1, L2)	Indoor unit connection pipe diameter ²⁾		
Unit type capacity	100	125	50	60	71 - 140	36	45	50	60	71	200	250	100 - 125	50	60 - 125
Liquid pipe (mm)	Ø 9,52	Ø 12,70	Ø 6,35	Ø 9,52	Ø 9,52	Ø 6,35	Ø 6,35	Ø 6,35	Ø 9,52	Ø 9,52	Ø 9,52	Ø 12,70	Ø 9,52	Ø 6,35	Ø 9,52
Gas pipe (mm)	Ø 15,88	Ø 15,88	Ø 12,70	Ø 15,88	Ø 15,88	Ø 12,70	Ø 12,70	Ø 12,70	Ø 15,88	Ø 15,88	Ø 25,40	Ø 25,40	Ø 15,88	Ø 12,70	Ø 15,88
Additional gas amount (g/m)	50	50	20	50	50	20	20	20	50	50	60	80	45	20	45

1) Total capacity of indoor unit connected after the branch. 2) 4 Way Cassette type.

Make additional charges by adding up tube length in an order of main tube (L) → branch tube (L1 → L2 → L3 wide diameter) and then selecting the amount of refrigerant corresponding to the remaining (after charge-less tube length: 30 m) liquid tube diameter and tube length from the above table.

Due to the ongoing innovation of our products, the specifications of this catalogue are valid barring typographic errors, and may be subject to minor modifications by the manufacturer without prior warning in order to improve the product. The total or partial reproduction of this catalogue is prohibited without the express authorisation of Panasonic Marketing Europe GmbH.

Panasonic®

To find out how Panasonic cares for you,
log on to: www.aircon.panasonic.eu

Panasonic Marketing Europe GmbH
Panasonic Air Conditioning
Hagenauer Strasse 43, 65203 Wiesbaden, Germany



Do not add or replace refrigerant other than the specified type. Manufacturer is not responsible for the damage and deterioration in safety due to usage of the other refrigerant.
The outdoor units in this catalogue contains fluorinated greenhouse gases with a GWP higher than 150.

